



**THE DATASHEET OF
LNJ311G8TRU**



Surface Mounting Chip LED

Through-The-Board Type

Conventional Part No. Global Part No. Lighting Color
 LNJ211R8ARU LNJ211R8ARU Red
 LNJ311G8TRU LNJ311G8TRU Green
 LNJ411K8YRU LNJ411K8YRU Amber

■ Absolute Maximum Ratings ($T_a = 25^\circ\text{C}$)

Lighting Color	P_D (mW)	I_F (mA)	I_{FP} (mA)*	V_R (V)	T_{opr} ($^\circ\text{C}$)	T_{stg} ($^\circ\text{C}$)
Red	60	20	100	3	-30 ~ +85	-40 ~ +100
Green	60	20	100	4	-30 ~ +85	-40 ~ +100
Amber	60	20	100	4	-30 ~ +85	-40 ~ +100

I_{FP} の条件は $duty$ 10% Pulse width 1 msec. The condition of I_{FP} is duty 10%, Pulse width 1 msec

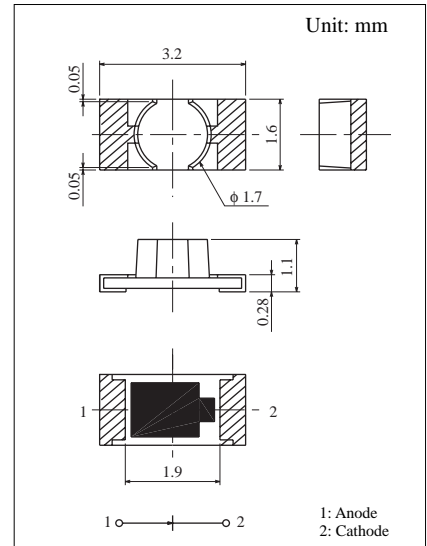

■ Electro-Optical Characteristics ($T_a = 25^\circ\text{C}$)

Conventional Part No.	Lighting Color	Lens Color	I_O		I_F	V_F		λ_p	$\Delta\lambda$	I_F	I_R	
			Typ	Min		Typ	Max				Max	V_R
LNJ211R8ARU	Red	Red Diffused	7.0	2.3	10	1.72	2.5	660	20	10	100	3
LNJ311G8TRU	Green	Green Diffused	5.5	1.8	10	2.03	2.6	565	30	10	10	4
LNJ411K8YRU	Amber	Yellow Diffused	2.2	0.75	10	2.0	2.6	590	30	10	10	4
Unit	—	—	mcd	mcd	mA	V	V	nm	nm	mA	μA	V

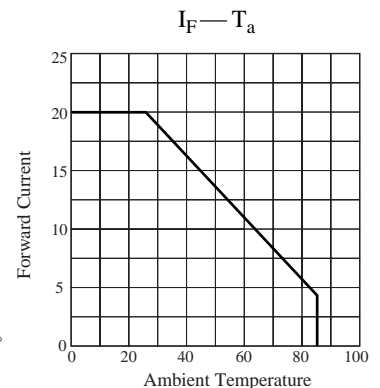
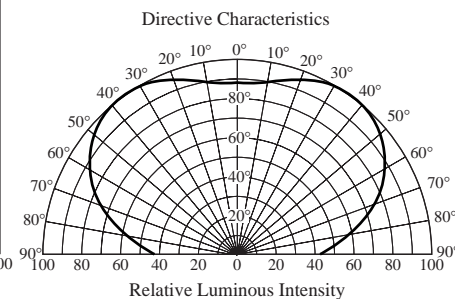
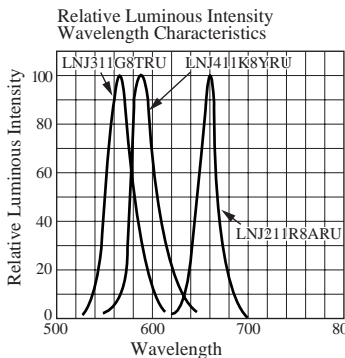
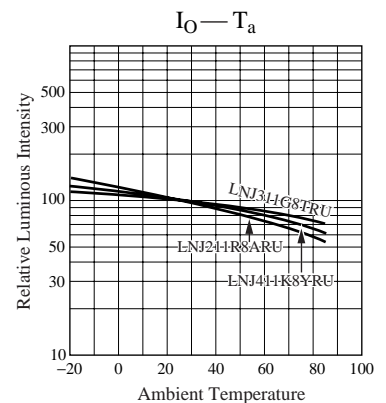
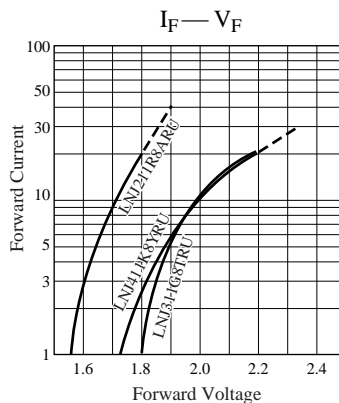
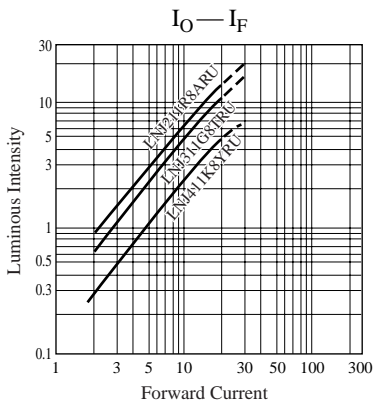







Looking for pricing, stock, or lifecycle information?

Click below to explore more details on WIN SOURCE:

 [View LNJ311G8TRU on WIN SOURCE](#)

 [Panasonic Information](#)

Optimize Your Supply Chain with WIN SOURCE Solutions

-  Global Sourcing Solution
-  Obsolete Management
-  Cost Control Management
-  Shortage Management
-  Alternative Solution
-  Excess Inventory Management