



**THE DATASHEET OF
LMX393HAUA+T**





General-Purpose, Low-Voltage, Single/Dual/Quad, Tiny-Pack Comparators

General Description

The LMX331/LMX393/LMX339 single/dual/quad comparators are drop-in, pin-for-pin-compatible replacements for the LMV331/LMV393/LMV339. The LMX331H/LMX393H/LMX339H offer the performance of the LMX331/LMX393/LMX339 with the added benefit of internal hysteresis to provide noise immunity, preventing output oscillations even with slow-moving input signals.

Advantages of the LMX331/LMX393/LMX339 series include low supply voltage, small package, and low cost. The LMX331 is available in both 5-pin SC70 and SOT23 packages, LMX393 is available in both 8-pin μ MAX[®] and smaller SOT23 packages, and the LMX339 is available in 14-pin TSSOP and SO packages. They are manufactured using advanced submicron CMOS technology. Designed with the most modern techniques, the LMX331/LMX393/LMX339 achieve superior performance over BiCMOS or bipolar versions on the market.

The LMX331/LMX393/LMX339 offer performance advantages such as wider supply voltage range, wider operating temperature range, better CMRR and PSRR, improved response time characteristics, reduced offset, reduced output saturation voltage, reduced input bias current, and improved RF immunity.

μ MAX is a registered trademark of Maxim Integrated Products, Inc.

Applications

Mobile Communications
Notebooks and PDAs
Automotive Applications
Battery-Powered Electronics
General-Purpose Portable Devices
General-Purpose Low-Voltage Applications

Features

- ◆ Guaranteed 1.8V to 5.5V Performance
- ◆ -40°C to +125°C Automotive Temperature Range
- ◆ Low Supply Current (60 μ A/Comparator at $V_{DD} = 5.0V$)
- ◆ Input Common-Mode Voltage Range Includes Ground
- ◆ No Phase Reversal for Overdriven Inputs
- ◆ Low Output Saturation Voltage (100mV)
- ◆ Internal 2mV Hysteresis (LMX331H/LMX393H/LMX339H)
- ◆ 5-Pin SC70 Space-Saving Package (2.0mm \times 2.1mm \times 1.0mm) (LMX331/LMX331H)

Ordering Information

PART	TEMP RANGE	PIN-PACKAGE	TOP MARK
LMX331AXK+T	-40°C to +125°C	5 SC70	ACD
LMX331AUK+T	-40°C to +125°C	5 SOT23	ADQR
LMX331HAXK+T	-40°C to +125°C	5 SC70	ACE
LMX331HAUK+T	-40°C to +125°C	5 SOT23	ADQS
LMX393AKA+T	-40°C to +125°C	8 SOT23	AAIF
LMX393AUA+T	-40°C to +125°C	8 μ MAX	—
LMX393HAKA+T	-40°C to +125°C	8 SOT23	AAIG
LMX393HAUA+T	-40°C to +125°C	8 μ MAX	—
LMX339AUD+T	-40°C to +125°C	14 TSSOP	—
LMX339ASD+T	-40°C to +125°C	14 SO	—
LMX339HAUD+T	-40°C to +125°C	14 TSSOP	—
LMX339HASD+T	-40°C to +125°C	14 SO	—

+ Denotes a lead(Pb)-free/RoHS-compliant package.
T = Tape and reel.

Pin Configurations

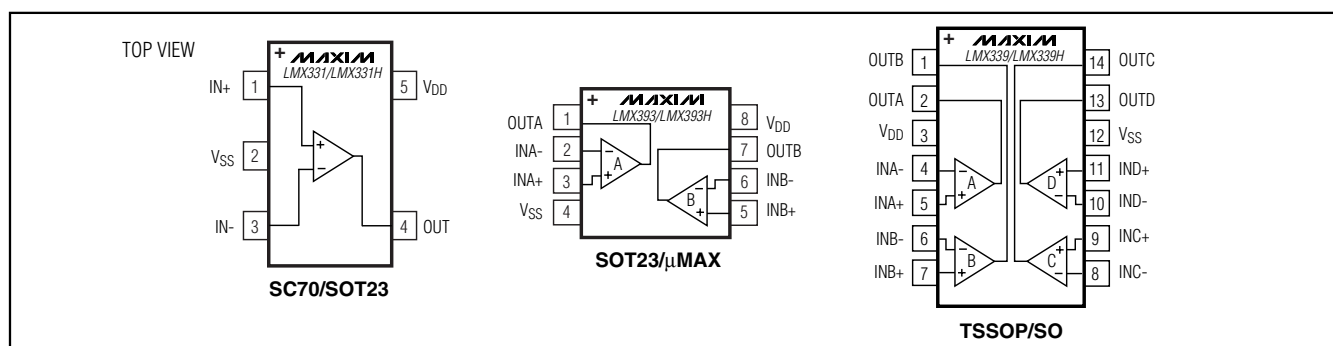

General-Purpose, Low-Voltage, Single/Dual/Quad, Tiny-Pack Comparators

ABSOLUTE MAXIMUM RATINGS

Supply Voltage (V _{DD} to V _{SS}).....	-0.3V to +6V	14-Pin TSSOP (derate 9.1mW/°C above +70°C).....	727mW
All Other Pins	(V _{SS} - 0.3V) to (V _{DD} + 0.3V)	14-Pin SO (derate 8.3mW/°C above +70°C).....	666.7mW
Continuous Power Dissipation (T _A = +70°C)		Operating Temperature Range	-40°C to +125°C
5-Pin SC70 (derate 3.1mW/°C above +70°C).....	247mW	Junction Temperature	+150°C
5-Pin SOT23 (derate 7.1mW/°C above +70°C).....	571mW	Storage Temperature Range	-65°C to +150°C
8-Pin SOT23 (derate 8.9mW/°C above +70°C).....	714mW	Lead Temperature (soldering, 10s).....	+300°C
8-Pin μMAX (derate 10.3mW/°C above +70°C).....	825mW	Soldering Temperature (reflow).....	+260°C

Stresses beyond those listed under "Absolute Maximum Ratings" may cause permanent damage to the device. These are stress ratings only, and functional operation of the device at these or any other conditions beyond those indicated in the operational sections of the specifications is not implied. Exposure to absolute maximum rating conditions for extended periods may affect device reliability.

DC ELECTRICAL CHARACTERISTICS—2.7V OPERATION

(V_{DD} = 2.7V, V_{SS} = 0V, V_{CM} = 0V, R_L = 5.1kΩ connected to V_{DD}. Typical values are at T_A = +25°C. **Boldface** limits apply at the defined temperature extremes.) (Note 1)

PARAMETER	SYMBOL	CONDITIONS	MIN	TYP	MAX	UNITS
Input Offset Voltage	V _{OS}			0.2	7	mV
Input Voltage Hysteresis	V _{HYST}	LMX331H/LMX393H/LMX339H only		2		mV
Input Offset Voltage Average Temperature Drift	TCV _{OS}			5		μV/°C
Input Bias Current	I _B	T _A = +25°C		±0.05	±250	nA
		T _A = -40°C to +85°C			±400	
		T _A = -40°C to +125°C			±400	
Input Offset Current	I _{OS}	T _A = +25°C		±0.05	±50	nA
		T _A = -40°C to +85°C			±150	
		T _A = -40°C to +125°C			±150	
Input Voltage Range	V _{CM}			-0.1		V
				2.0		
Voltage Gain	A _V	LMX331/LMX393/LMX339 only		50		V/mV
Output Saturation Voltage	V _{SAT}	I _{SINK} ≤ 1mA		50		mV
Output Sink Current	I _O	V _O ≤ 1.5V	5	37		mA
Supply Current (Note 2)	I _S	LMX331/LMX331H		50	100	μA
		LMX393/LMX393H (both comparators)		70	140	
		LMX339/LMX339H (all four comparators)		140	200	
Output Leakage Current		T _A = +25°C		0.003		μA
		T _A = -40°C to +85°C			1	
		T _A = -40°C to +125°C			2	

AC ELECTRICAL CHARACTERISTICS—2.7V OPERATION

(V_{DD} = 2.7V, V_{SS} = 0V, V_{CM} = 0V, R_L = 5.1kΩ connected to V_{DD}. Typical values are at T_A = +25°C. **Boldface** limits apply at the defined temperature extremes.) (Note 1)

PARAMETER	SYMBOL	CONDITIONS	MIN	TYP	MAX	UNITS
Propagation Delay Output High to Low	t _{PHL}	Input overdrive = 10mV (Note 3)		500		ns
		Input overdrive = 100mV (Note 3)		100		
Propagation Delay Output Low to High	t _{PLH}	Input overdrive = 10mV (Note 3)		500		ns
		Input overdrive = 100mV (Note 3)		100		

General-Purpose, Low-Voltage, Single/Dual/Quad, Tiny-Pack Comparators

LMX331/LMX393/LMX339

DC ELECTRICAL CHARACTERISTICS—5.0V OPERATION

($V_{DD} = 5V$, $V_{SS} = 0V$, $V_{CM} = 0V$, $R_L = 5.1k\Omega$ connected to V_{DD} . Typical values are at $T_A = +25^\circ C$. **Boldface** limits apply at the defined temperature extremes.) (Note 1)

PARAMETER	SYMBOL	CONDITIONS		MIN	TYP	MAX	UNITS
Input Offset Voltage	V_{OS}	$T_A = +25^\circ C$			0.25	7	mV
		$T_A = -40^\circ C$ to $+85^\circ C$				9	
		$T_A = -40^\circ C$ to $+125^\circ C$				9	
Input Voltage Hysteresis		LMX331H/LMX393H/LMX339H only			2		mV
Input Offset Voltage Average Temperature Drift	TCV_{OS}				5		$\mu V/^\circ C$
Input Bias Current	I_B	$T_A = +25^\circ C$			± 0.05	± 250	nA
		$T_A = -40^\circ C$ to $+85^\circ C$				± 400	
		$T_A = -40^\circ C$ to $+125^\circ C$				± 400	
Input Offset Current	I_{OS}	$T_A = +25^\circ C$			± 0.05	± 50	nA
		$T_A = -40^\circ C$ to $+85^\circ C$				± 150	
		$T_A = -40^\circ C$ to $+125^\circ C$				± 150	
Input Voltage Range	V_{CM}				-0.1		V
					4.2		
Voltage Gain	A_V	LMX331/LMX393/LMX339 only		20	50		V/mV
Output Saturation Voltage	V_{SAT}	$I_{SINK} \leq 4mA$	$T_A = +25^\circ C$		70	400	mV
			$T_A = -40^\circ C$ to $+85^\circ C$			700	
			$T_A = -40^\circ C$ to $+125^\circ C$			700	
Output Sink Current	I_O	$V_O \leq 1.5V$		10	73		mA
Supply Current (Note 2)	I_S	LMX331/LMX331H	$T_A = +25^\circ C$		60	120	μA
			$T_A = -40^\circ C$ to $+85^\circ C$			150	
			$T_A = -40^\circ C$ to $+125^\circ C$			170	
		LMX393/LMX393H (both comparators)	$T_A = +25^\circ C$		100	200	
			$T_A = -40^\circ C$ to $+85^\circ C$			250	
			$T_A = -40^\circ C$ to $+125^\circ C$			300	
		LMX339/LMX339H (all four comparators)	$T_A = +25^\circ C$		170	300	
			$T_A = -40^\circ C$ to $+85^\circ C$			350	
			$T_A = -40^\circ C$ to $+125^\circ C$			430	
Output Leakage Current		$T_A = +25^\circ C$			0.003		μA
		$T_A = -40^\circ C$ to $+85^\circ C$				1	
		$T_A = -40^\circ C$ to $+125^\circ C$				2	

AC ELECTRICAL CHARACTERISTICS—5.0V OPERATION

($V_{DD} = 5V$, $V_{SS} = 0V$, $V_{CM} = 0V$, $R_L = 5.1k\Omega$ connected to V_{DD} . Typical values are at $T_A = +25^\circ C$. **Boldface** limits apply at the defined temperature extremes.) (Note 1)

PARAMETER	SYMBOL	CONDITIONS	MIN	TYP	MAX	UNITS
Propagation Delay Output High to Low	t_{PHL}	Input overdrive = 10mV (Note 3)		400		ns
		Input overdrive = 100mV (Note 3)		90		
Propagation Delay Output Low to High	t_{PLH}	Input overdrive = 10mV (Note 3)		600		ns
		Input overdrive = 100mV (Note 3)		200		

General-Purpose, Low-Voltage, Single/Dual/Quad, Tiny-Pack Comparators

DC ELECTRICAL CHARACTERISTICS—1.8V OPERATION

($V_{DD} = 1.8V$, $V_{SS} = 0V$, $V_{CM} = 0V$, $R_L = 5.1k\Omega$ connected to V_{DD} . Typical values are at $T_A = +25^\circ C$. **Boldface** limits apply at the defined temperature extremes.) (Note 1)

PARAMETER	SYMBOL	CONDITIONS	MIN	TYP	MAX	UNITS
Input Offset Voltage	V_{OS}			0.2	5	mV
Input Voltage Hysteresis		LMX331H/LMX393H/LMX339H only		2		mV
Input Offset Voltage Average Temperature Drift	TCV_{OS}			5		$\mu V/^\circ C$
Input Bias Current	I_B			0.05		nA
Input Offset Current	I_{OS}			0.05		nA
Input Voltage Range	V_{CM}			-0.1		V
				1		
Output Saturation Voltage	V_{SAT}	$I_{SINK} \leq 1mA$		35		mV
Power-Supply Rejection Ratio	PSRR	$V_{DD} = 1.8V$ to $5.5V$	60	70		dB
Output Sink Current	I_O	$V_O \leq 1.5V$		15		mA
Supply Current (Note 2)	I_S	LMX331/LMX331H		40	100	μA
		LMX393/LMX393H (both comparators)		65	140	
		LMX339/LMX339H (all four comparators)		120	200	
Output Leakage Current				0.003		μA

AC ELECTRICAL CHARACTERISTICS—1.8V OPERATION

($V_{DD} = 1.8V$, $V_{SS} = 0V$, $V_{CM} = 0V$, $R_L = 5.1k\Omega$ connected to V_{DD} . Typical values are at $T_A = +25^\circ C$. **Boldface** limits apply at the defined temperature extremes.) (Note 1)

PARAMETER	SYMBOL	CONDITIONS	MIN	TYP	MAX	UNITS
Propagation Delay Output High to Low	t_{PHL}	Input overdrive = 10mV (Note 3)		500		ns
		Input overdrive = 100mV (Note 3)		100		
Propagation Delay Output Low to High	t_{PLH}	Input overdrive = 10mV (Note 3)		500		ns
		Input overdrive = 100mV (Note 3)		100		

Note 1: All devices are production tested at $+25^\circ C$. All temperature limits are guaranteed by design.

Note 2: Supply current when output is high.

Note 3: Input overdrive is the overdrive voltage beyond the offset and hysteresis-determined trip points.

General-Purpose, Low-Voltage, Single/Dual/Quad, Tiny-Pack Comparators

Typical Operating Characteristics

($V_{DD} = 5V$, $V_{SS} = 0V$, $V_{CM} = 0V$, $R_L = 5.1k\Omega$, $C_L = 10pF$, overdrive = 100mV, $T_A = +25^\circ C$, unless otherwise noted.)

LMX331/LMX393/LMX339

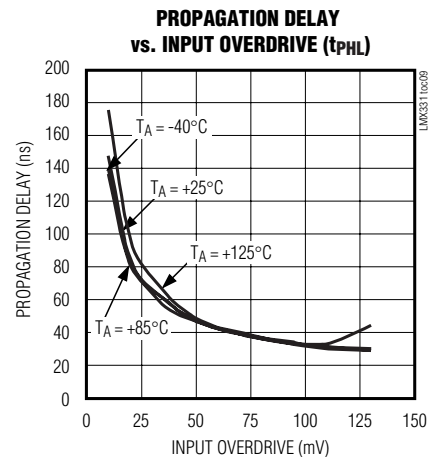
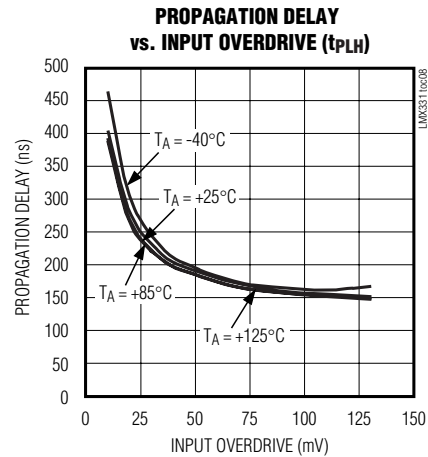
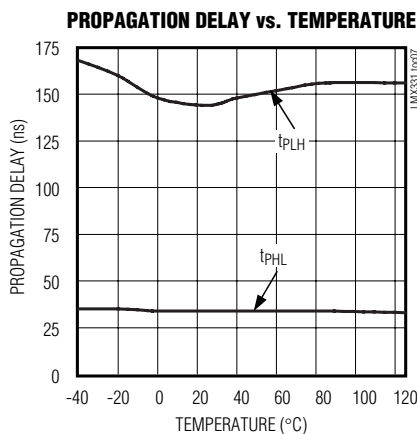
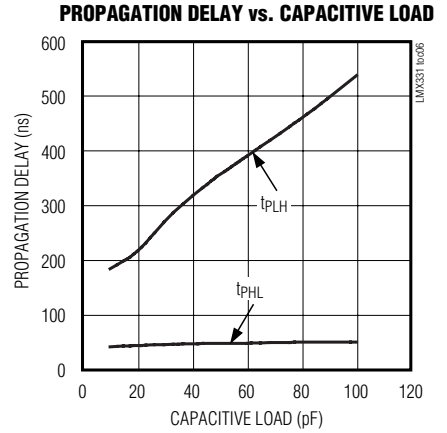
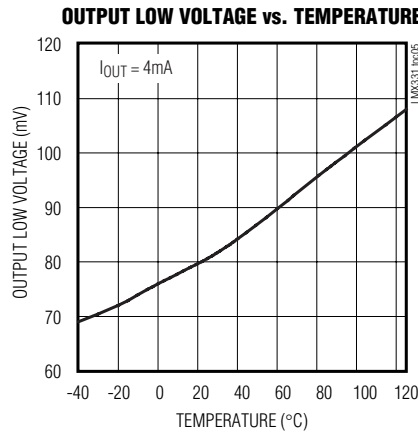
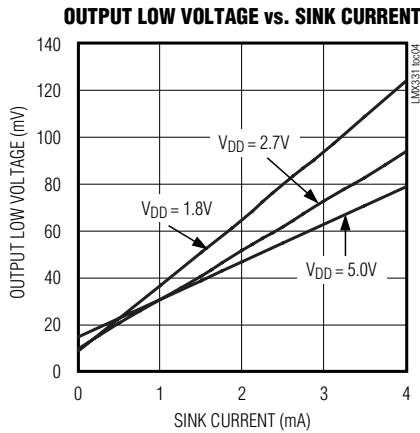
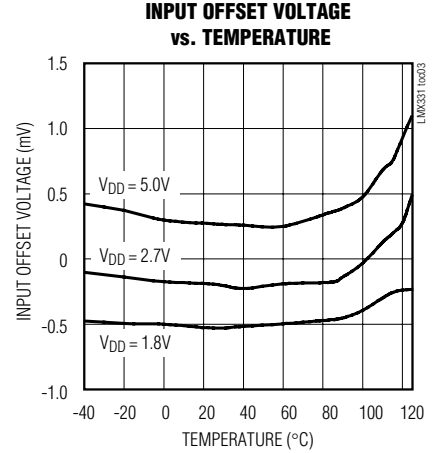
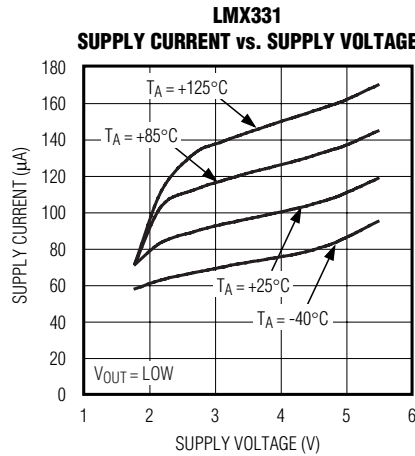
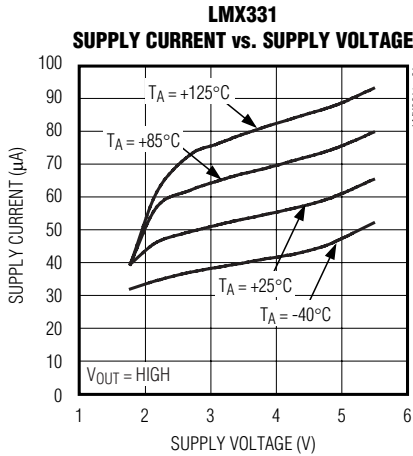

General-Purpose, Low-Voltage, Single/Dual/Quad, Tiny-Pack Comparators

Typical Operating Characteristics (continued)

($V_{DD} = 5V$, $V_{SS} = 0V$, $V_{CM} = 0V$, $R_L = 5.1k\Omega$, $C_L = 10pF$, overdrive = 100mV, $T_A = +25^\circ C$, unless otherwise noted.)

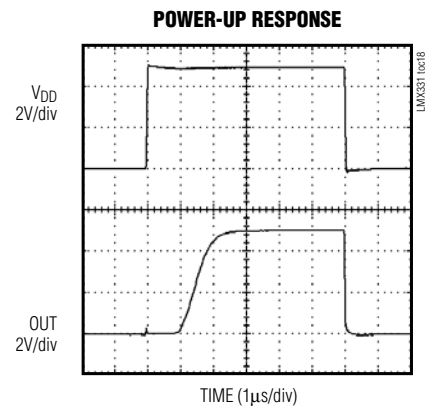
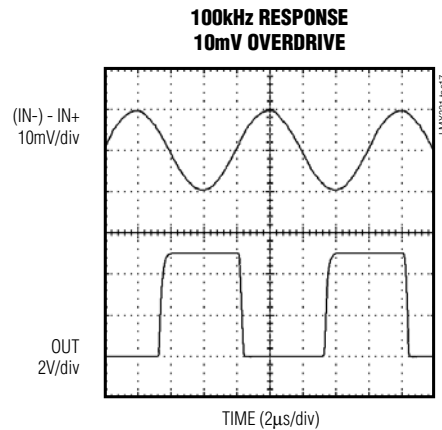
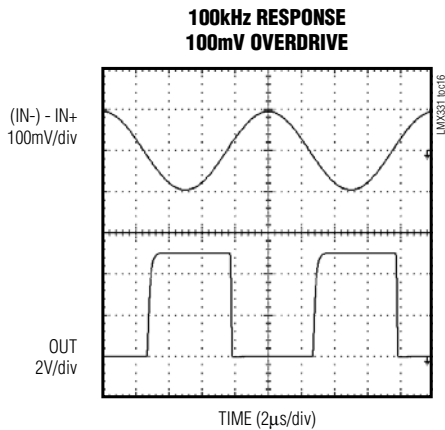
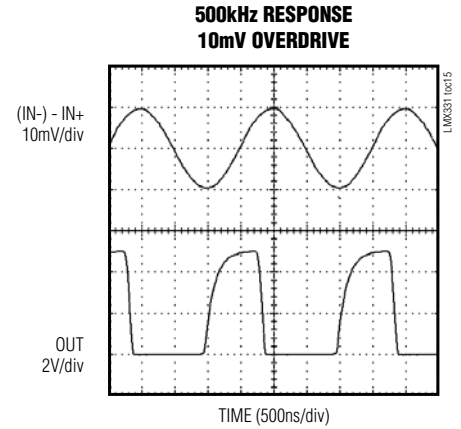
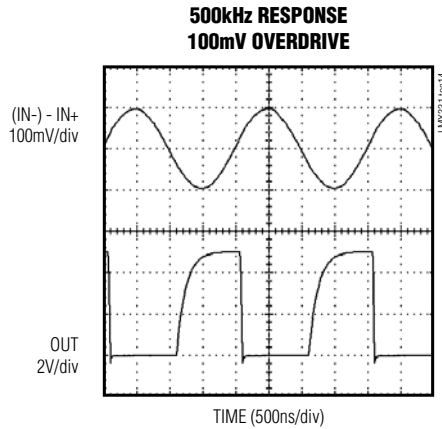
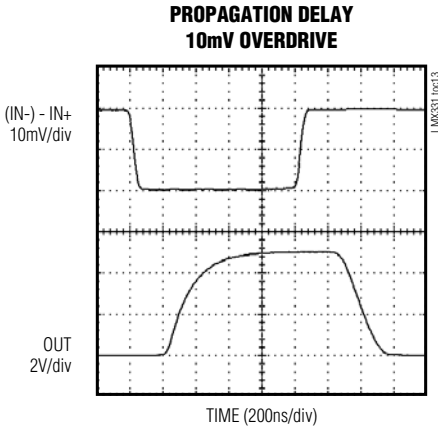
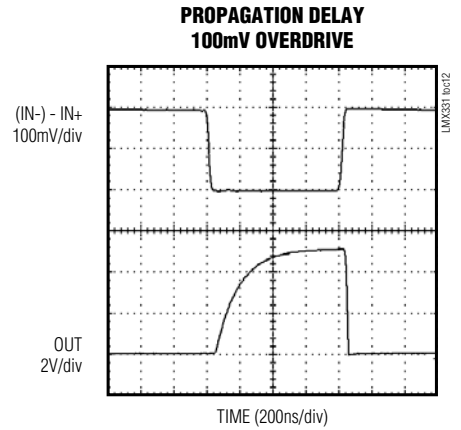
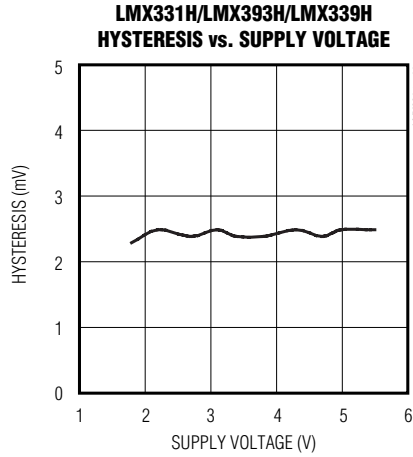
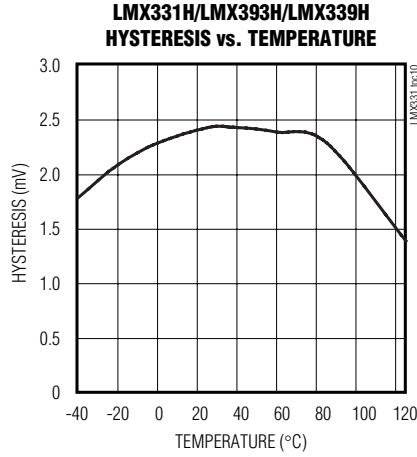

General-Purpose, Low-Voltage, Single/Dual/Quad, Tiny-Pack Comparators

Pin Description

LMX331/LMX393/LMX339

PIN			NAME	FUNCTION
LMX331	LMX393	LMX339		
1	—	—	IN+	Noninverting Input
2	4	12	V _{SS}	Negative Supply (Connect to GND)
3	—	—	IN-	Inverting Input
4	—	—	OUT	Comparator Output (Open-Drain)
5	8	3	V _{DD}	Positive Supply
—	1	2	OUTA	Comparator A Output (Open-Drain)
—	7	1	OUTB	Comparator B Output (Open-Drain)
—	2	4	INA-	Comparator A Inverting Input
—	3	5	INA+	Comparator A Noninverting Input
—	5	7	INB+	Comparator B Noninverting Input
—	6	6	INB-	Comparator B Inverting Input
—	—	8	INC-	Comparator C Inverting Input
—	—	9	INC+	Comparator C Noninverting Input
—	—	10	IND-	Comparator D Inverting Input
—	—	11	IND+	Comparator D Noninverting Input
—	—	13	OUTD	Comparator D Output (Open-Drain)
—	—	14	OUTC	Comparator C Output (Open-Drain)

Detailed Description

The LMX331/LMX393/LMX339 are single/dual/quad, low-cost, general-purpose comparators. They have a single-supply operating voltage of 1.8V to 5V. The common-mode input range extends from -0.1V below the negative supply to within 0.7V of the positive supply. They require approximately 60μA per comparator with a 5V supply and 40μA with a 2.7V supply.

The LMX331H/LMX393H/LMX339H have 2mV of hysteresis for noise immunity. This significantly reduces the chance of output oscillations even with slow-moving input signals. The LMX331/LMX393/LMX339 and LMX331H/LMX393H/LMX339H are ideal for automotive applications because they operate from -40°C to +125°C (see *Typical Operating Characteristics*).

Applications Information

Hysteresis

Many comparators oscillate in the linear region of operation because of noise or undesired parasitic feedback. This tends to occur when the voltage on one input is equal or very close to the voltage on the other input. The LMX331H/LMX393H/LMX339H have internal hysteresis to counter parasitic effects and noise.

The hysteresis in a comparator creates two trip points: one for the rising input voltage and one for the falling

input voltage (Figure 1). The difference between the trip points is the hysteresis. When the comparator's input voltages are equal, the hysteresis effectively causes one comparator input to move quickly past the other, thus taking the input out of the region where oscillation occurs. This provides clean output transitions for noisy, slow-moving input signals.

Additional hysteresis can be generated with two resistors, using positive feedback (Figure 2). Use the following procedure to calculate resistor values:

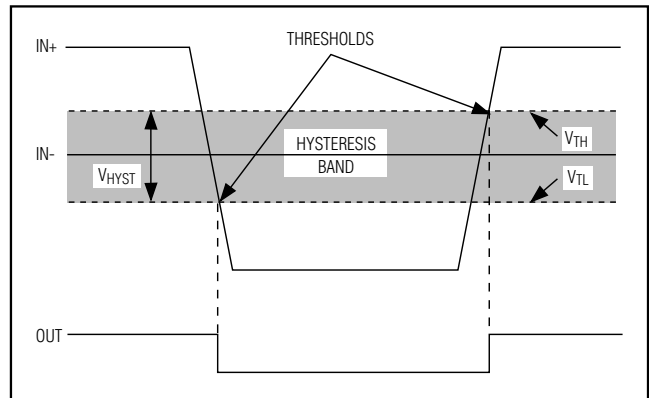

Figure 1. Threshold Hysteresis Band (Not to Scale)

General-Purpose, Low-Voltage, Single/Dual/Quad, Tiny-Pack Comparators

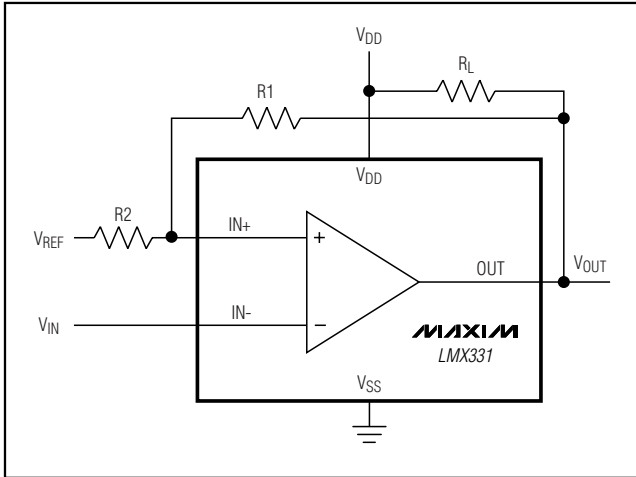

Figure 2. Adding Hysteresis with External Resistors

- 1) Find output voltage when output is high:

$$V_{OUT(HIGH)} = V_{DD} - I_{LOAD} \times R_L$$
- 2) Find the trip points of the comparator using these formulas:

$$V_{TH} = V_{REF} + ((V_{OUT(HIGH)} - V_{REF})R_2) / (R_1 + R_2)$$

$$V_{TL} = V_{REF}(1 - (R_2 / (R_1 + R_2)))$$

where V_{TH} is the threshold voltage at which the comparator switches its output from high to low as V_{IN} rises above the trip point, and V_{TL} is the threshold voltage at which the comparator switches its output from low to high as V_{IN} drops below the trip point.

- 3) The hysteresis band will be:

$$V_{HYST} = V_{TH} - V_{TL} = V_{DD}(R_2 / (R_1 + R_2))$$
- In this example, let $V_{DD} = 5V$, $V_{REF} = 2.5V$, $I_{LOAD} = 50nA$, $R_L = 5.1k\Omega$:

$$V_{OUT(HIGH)} = 5.0V - (50 \times 10^{-9} \times 5.1 \times 10^3\Omega) \approx 5.0V$$

$$V_{TH} = 2.5V + 2.5V(R_2 / (R_1 + R_2))$$

$$V_{TL} = 2.5V(1 - (R_2 / (R_1 + R_2)))$$

Select R_2 . In this example, we will choose $1k\Omega$.
 Select V_{HYST} . In this example, we will choose $50mV$.
 Solve for R_1 :

$$V_{HYST} = V_{OUT(HIGH)}(R_2 / (R_1 + R_2)) V$$

$$0.050V = 5(1000 / (R_1 + 1000)) V$$

where $R_1 \approx 100k\Omega$, $V_{TH} = 2.525V$, and $V_{TL} = 2.475V$.
 Choose R_1 and R_2 to be large enough as not to exceed the amount of current the reference can supply.

The source current required is $V_{REF} / (R_1 + R_2)$.

The sink current is $(V_{OUT(HIGH)} - V_{REF}) \times (R_1 + R_2)$.

Choose R_L to be large enough to avoid drawing excess current, yet small enough to supply the necessary current to drive the load. R_L should be between $1k\Omega$ and $10k\Omega$.

Board Layout and Bypassing

Use $0.1\mu F$ bypass capacitors from V_{DD} to V_{SS} . To maximize performance, minimize stray inductance by putting this capacitor close to the V_{DD} pin and reducing trace lengths. For slow-moving input signals (rise time $> 1ms$), use a $1nF$ capacitor between $IN+$ and $IN-$ to reduce high-frequency noise.

Chip Information

LMX331/LMX331H TRANSISTOR COUNT: 112
 LMX393/LMX393H TRANSISTOR COUNT: 211
 LMX339/LMX339H TRANSISTOR COUNT: 411

Package Information

For the latest package outline information and land patterns, go to www.maxim-ic.com/packages. Note that a "+", "#", or "-" in the package code indicates RoHS status only. Package drawings may show a different suffix character, but the drawing pertains to the package regardless of RoHS status.

PACKAGE TYPE	PACKAGE CODE	DOCUMENT NO.	LAND PATTERN NO.
5 SC70	X5+1	21-0076	90-0188
5 SOT23	U5+2	21-0057	90-0174
8 SOT23	K8F+4	21-0078	90-0176
8 μ MAX	U8+1	21-0036	90-0092
14 TSSOP	U16M+1	21-0066	90-0117
14 SOIC	S8+4	21-0041	90-0041

General-Purpose, Low-Voltage, Single/Dual/Quad, Tiny-Pack Comparators

Revision History

REVISION NUMBER	REVISION DATE	DESCRIPTION	PAGES CHANGED
3	8/10	Added lead-free parts	1
4	5/11	Added thermal data	2, 3, 4

LMX331/LMX393/LMX339

Maxim cannot assume responsibility for use of any circuitry other than circuitry entirely embodied in a Maxim product. No circuit patent licenses are implied. Maxim reserves the right to change the circuitry and specifications without notice at any time.

Maxim Integrated Products, 120 San Gabriel Drive, Sunnyvale, CA 94086 408-737-7600 _____ 9

Looking for pricing, stock, or lifecycle information?

Click below to explore more details on WIN SOURCE:

- [View LMX393HAUA+T on WIN SOURCE](#)
- [Maxim Integrated Information](#)

Optimize Your Supply Chain with WIN SOURCE Solutions

- ✓ Global Sourcing Solution
- ✓ Obsolete Management
- ✓ Cost Control Management
- ✓ Shortage Management
- ✓ Alternative Solution
- ✓ Excess Inventory Management