



# THE DATASHEET OF LMV924MTX



## LMV921/LMV922/LMV924 Single, Dual and Quad 1.8V, 1MHz, Low Power Operational Amplifiers with Rail-To-Rail Input and Output

Check for Samples: [LMV921](#), [LMV922](#), [LMV924](#)

### FEATURES

- (Typical 1.8V Supply Values; Unless Otherwise Noted)
- Ensured 1.8V, 2.7V and 5V Specifications
- Rail-to-Rail Input & Output Swing
- w/600Ω Load 100 mV from Rail
- w/2kΩ Load 30 mV from Rail
- $V_{CM}$  300mV Beyond Rails
- Supply Current 145μA/amplifier
- Gain Bandwidth Product 1MHz
- LMV921 Maximum  $V_{OS}$  6mV
- 90dB Gain w/600Ω Load
- LMV921 Available in Ultra Tiny, SC70-5 Package
- LMV922 Available in VSSOP-8 Package
- LMV924 Available in TSSOP-14 Package

### APPLICATIONS

- Cordless/Cellular Phones
- Laptops
- PDAs
- PCMCIA
- Portable/Battery-Powered Electronic Equipment
- Supply Current Monitoring
- Battery Monitoring

### DESCRIPTION

The LMV921 Single/LMV922 Dual/LMV924 Quad are ensured to operate from +1.8V to +5.0V supply voltages and have rail-to-rail input and output. This rail-to-rail operation enables the user to make full use of the entire supply voltage range. The input common mode voltage range extends 300mV beyond the supplies and the output can swing rail-to-rail unloaded and within 100mV from the rail with 600Ω load at 1.8V supply. The LMV921/LMV922/LMV924 are optimized to work at 1.8V which make them ideal for portable two-cell battery-powered systems and single cell Li-Ion systems.

The LMV921/LMV922/LMV924 exhibit excellent speed-power ratio, achieving 1MHz gain bandwidth product at 1.8V supply voltage with very low supply current. The LMV921/LMV922/LMV924 are capable of driving 600Ω load and up to 1000pF capacitive load with minimal ringing. The LMV921/LMV922/LMV924's high DC gain of 100dB makes them suitable for low frequency applications.

The LMV921 (Single) is offered in a space saving SC70–5 and SOT–23–5 packages. The SC70–5 package is only 2.0X2.1X1.0mm. These small packages are ideal solutions for area constrained PC boards and portable electronics such as cellphones and PDAs.

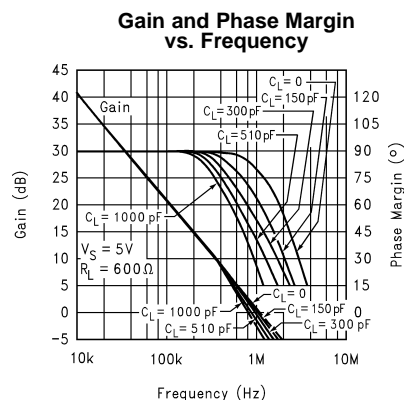
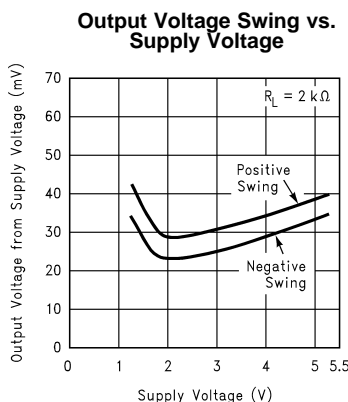
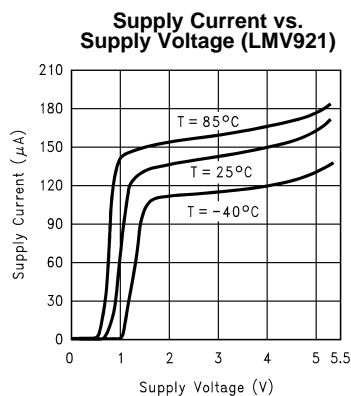

Please be aware that an important notice concerning availability, standard warranty, and use in critical applications of Texas Instruments semiconductor products and disclaimers thereto appears at the end of this data sheet.

All trademarks are the property of their respective owners.



These devices have limited built-in ESD protection. The leads should be shorted together or the device placed in conductive foam during storage or handling to prevent electrostatic damage to the MOS gates.

### ABSOLUTE MAXIMUM RATINGS<sup>(1)(2)</sup>

ESD Tolerance <sup>(3)</sup>	Machine Model	100V
	Human Body Model	2000V
Differential Input Voltage		± Supply Voltage
Supply Voltage (V <sup>+</sup> –V <sup>–</sup> )		5.5V
Output Short Circuit to V <sup>+</sup> <sup>(4)</sup>		
Output Short Circuit to V <sup>–</sup> <sup>(4)</sup>		
Storage Temperature Range		–65°C to 150°C
Junction Temperature <sup>(5)</sup>		150°C
Mounting Temp.	Infrared or Convection (20 sec)	235°C

- (1) Absolute Maximum Ratings indicate limits beyond which damage to the device may occur. Operating Ratings indicate conditions for which the device is intended to be functional, but specific performance is not ensured. For ensured specifications and the test conditions, see the Electrical Characteristics.
- (2) If Military/Aerospace specified devices are required, please contact the TI Sales Office/ Distributors for availability and specifications.
- (3) Human body model, 1.5 kΩ in series with 100pF. Machine model, 200Ω in series with 100 pF.
- (4) Applies to both single-supply and split-supply operation. Continuous short circuit operation at elevated ambient temperature can result in exceeding the maximum allowed junction temperature of 150°C. Output currents in excess of 45mA over long term may adversely affect reliability.
- (5) The maximum power dissipation is a function of T<sub>J(max)</sub>, θ<sub>JA</sub>, and T<sub>A</sub>. The maximum allowable power dissipation at any ambient temperature is P<sub>D</sub> = (T<sub>J(max)</sub>–T<sub>A</sub>)/θ<sub>JA</sub>. All numbers apply for packages soldered directly into a PC board.

### OPERATING RATINGS<sup>(1)</sup>

Supply Voltage			1.5V to 5.0V
Temperature Range			–40°C ≤ T <sub>J</sub> ≤ 85°C
Thermal Resistance (θ <sub>JA</sub> )	Ultra Tiny SC70-5 Package	5-Pin Surface Mount	440 °C/W
	Tiny SOT-23-5 Package	5-Pin Surface Mount	265 °C/W
	VSSOP Package	8-Pin Surface Mount	235°C/W
	TSSOP Package	14-Pin Surface Mount	155°C/W
	SOIC Package	8-Pin Surface Mount	175°C/W
		14-Pin Surface Mount	127°C/W

- (1) Absolute Maximum Ratings indicate limits beyond which damage to the device may occur. Operating Ratings indicate conditions for which the device is intended to be functional, but specific performance is not ensured. For ensured specifications and the test conditions, see the Electrical Characteristics.

## 1.8V DC ELECTRICAL CHARACTERISTICS

Unless otherwise specified, all limits specified for  $T_J = 25^\circ\text{C}$ .  $V^+ = 1.8\text{V}$ ,  $V^- = 0\text{V}$ ,  $V_{\text{CM}} = V^+/2$ ,  $V_O = V^+/2$  and  $R_L > 1\text{M}\Omega$ .

**Boldface** limits apply at the temperature extremes.

Symbol	Parameter	Condition	Typ <sup>(1)</sup>	Limits <sup>(2)</sup>	Units
$V_{\text{OS}}$	Input Offset Voltage	LMV921 (Single)	-1.8	6 <b>8</b>	mV max
		LMV922 (Dual) LMV924 (Quad)	-1.8	8 <b>9.5</b>	mV max
$\text{TCV}_{\text{OS}}$	Input Offset Voltage Average Drift		1		$\mu\text{V}/^\circ\text{C}$
$I_{\text{B}}$	Input Bias Current		12	35 <b>50</b>	nA max
$I_{\text{OS}}$	Input Offset Current		2	25 <b>40</b>	nA max
$I_{\text{S}}$	Supply Current	LMV921 (Single)	145	185 <b>205</b>	$\mu\text{A}$ max
		LMV922 (Dual)	330	400 <b>550</b>	
		LMV924 (Quad)	560	700 <b>850</b>	
CMRR	Common Mode Rejection Ratio	$0 \leq V_{\text{CM}} \leq 0.6\text{V}$	82	62 <b>60</b>	dB min
		$-0.2\text{V} \leq V_{\text{CM}} \leq 0\text{V}$ $1.8\text{V} \leq V_{\text{CM}} \leq 2.0\text{V}$	74	50	
PSRR	Power Supply Rejection Ratio	$1.8\text{V} \leq V^+ \leq 5\text{V}$ , $V_{\text{CM}} = 0.5\text{V}$	78	67 <b>62</b>	dB min
$V_{\text{CM}}$	Input Common-Mode Voltage Range	For CMRR $\geq 50\text{dB}$	-0.3	-0.2 <b>0</b>	V min
			2.15	2.0 <b>1.8</b>	V max
$A_{\text{V}}$	Large Signal Voltage Gain LMV921 (Single)	$R_L = 600\Omega$ to 0.9V, $V_O = 0.2\text{V}$ to 1.6V, $V_{\text{CM}} = 0.5\text{V}$	91	77 <b>73</b>	dB min
		$R_L = 2\text{k}\Omega$ to 0.9V, $V_O = 0.2\text{V}$ to 1.6V, $V_{\text{CM}} = 0.5\text{V}$	95	80 <b>75</b>	
	Large Signal Voltage Gain LMV922 (Dual) LMV924 (Quad)	$R_L = 600\Omega$ to 0.9V, $V_O = 0.2\text{V}$ to 1.6V, $V_{\text{CM}} = 0.5\text{V}$	79	65 <b>61</b>	dB min
		$R_L = 2\text{k}\Omega$ to 0.9V, $V_O = 0.2\text{V}$ to 1.6V, $V_{\text{CM}} = 0.5\text{V}$	83	68 <b>63</b>	
$V_O$	Output Swing	$R_L = 600\Omega$ to 0.9V $V_{\text{IN}} = \pm 100\text{mV}$	1.7	1.65 <b>1.63</b>	V min
			0.075	0.090 <b>0.105</b>	V max
		$R_L = 2\text{k}\Omega$ to 0.9V $V_{\text{IN}} = \pm 100\text{mV}$	1.77	1.75 <b>1.74</b>	V min
			0.025	0.035 <b>0.040</b>	V max
$I_O$	Output Short Circuit Current	Sourcing, $V_O = 0\text{V}$ $V_{\text{IN}} = 100\text{mV}$	6	4 <b>3.3</b>	mA min
		Sinking, $V_O = 1.8\text{V}$ $V_{\text{IN}} = -100\text{mV}$	10	7 <b>5</b>	mA min

(1) Typical Values represent the most likely parametric norm.

(2) All limits are specified by testing or statistical analysis.

## 1.8V AC ELECTRICAL CHARACTERISTICS

Unless otherwise specified, all limits specified for  $T_J = 25^\circ\text{C}$ .  $V^+ = 1.8\text{V}$ ,  $V^- = 0\text{V}$ ,  $V_{\text{CM}} = V^+/2$ ,  $V_O = V^+/2$  and  $R_L > 1\text{M}\Omega$ .

**Boldface** limits apply at the temperature extremes.

Symbol	Parameter	Conditions	Typ <sup>(1)</sup>	Units
SR	Slew Rate	See <sup>(2)</sup>	0.39	V/ $\mu\text{s}$
GBW	Gain-Bandwidth Product		1	MHz
$\Phi_m$	Phase Margin		60	Deg
$G_m$	Gain Margin		10	dB
$e_n$	Input-Referred Voltage Noise	$f = 1\text{kHz}$ , $V_{\text{CM}} = 0.5\text{V}$	45	$\text{nV}/\sqrt{\text{Hz}}$
$i_n$	Input-Referred Current Noise	$f = 1\text{kHz}$	0.1	$\text{pA}/\sqrt{\text{Hz}}$
THD	Total Harmonic Distortion	$f = 1\text{kHz}$ , $A_V = +1$ $R_L = 600\text{k}\Omega$ , $V_{\text{IN}} = 1\text{V}_{\text{PP}}$	0.089	%
	Amp-to-Amp Isolation	See <sup>(3)</sup>	140	dB

(1) Typical Values represent the most likely parametric norm.

(2)  $V^+ = 5\text{V}$ . Connected as voltage follower with 5V step input. Number specified is the slower of the positive and negative slew rates.

(3) Input referred,  $V^+ = 5\text{V}$  and  $R_L = 100\text{k}\Omega$  connected to 2.5V. Each amp excited in turn with 1kHz to produce  $V_O = 3\text{V}_{\text{PP}}$ .

## 2.7V DC ELECTRICAL CHARACTERISTICS

Unless otherwise specified, all limits specified for  $T_J = 25^\circ\text{C}$ .  $V^+ = 2.7\text{V}$ ,  $V^- = 0\text{V}$ ,  $V_{\text{CM}} = V^+/2$ ,  $V_O = V^+/2$  and  $R_L > 1\text{M}\Omega$ .

**Boldface** limits apply at the temperature extremes.

Symbol	Parameter	Condition	Typ <sup>(1)</sup>	Limits <sup>(2)</sup>	Units
$V_{\text{OS}}$	Input Offset Voltage	LMV921 (Single)	-1.6	6 <b>8</b>	mV max
		LMV922 (Dual) LMV924 (Quad)	-1.6	8 <b>9.5</b>	mV max
$\text{TCV}_{\text{OS}}$	Input Offset Voltage Average Drift		1		$\mu\text{V}/^\circ\text{C}$
$I_B$	Input Bias Current		12	35 <b>50</b>	nA max
$I_{\text{OS}}$	Input Offset Current		2	25 <b>40</b>	nA max
$I_S$	Supply Current	LMV921 (Single)	147	190 <b>210</b>	uA max
		LMV922 (Dual)	380	450 <b>600</b>	
		LMV924 (Quad)	580	750 <b>900</b>	
CMRR	Common Mode Rejection Ratio	$0\text{V} \leq V_{\text{CM}} \leq 1.5\text{V}$	84	62 <b>60</b>	dB min
		$-0.2\text{V} \leq V_{\text{CM}} \leq 0\text{V}$ $2.7\text{V} \leq V_{\text{CM}} < 2.9\text{V}$	73	50	
PSRR	Power Supply Rejection Ratio	$1.8\text{V} \leq V^+ \leq 5\text{V}$ , $V_{\text{CM}} = 0.5\text{V}$	78	67 <b>62</b>	dB min
$V_{\text{CM}}$	Input Common-Mode Voltage Range	For CMRR $\geq 50\text{dB}$	-0.3	-0.2 <b>0</b>	V min
			3.050	2.9 <b>2.7</b>	V max

(1) Typical Values represent the most likely parametric norm.

(2) All limits are specified by testing or statistical analysis.

## 2.7V DC ELECTRICAL CHARACTERISTICS (continued)

Unless otherwise specified, all limits specified for  $T_J = 25^\circ\text{C}$ .  $V^+ = 2.7\text{V}$ ,  $V^- = 0\text{V}$ ,  $V_{\text{CM}} = V^+/2$ ,  $V_O = V^+/2$  and  $R_L > 1\text{M}\Omega$ .

**Boldface** limits apply at the temperature extremes.

Symbol	Parameter	Condition	Typ <sup>(1)</sup>	Limits <sup>(2)</sup>	Units
$A_V$	Large Signal Voltage Gain LMV921 (Single)	$R_L = 600\Omega$ to $1.35\text{V}$ , $V_O = 0.2\text{V}$ to $2.5\text{V}$	98	80 <b>75</b>	dB min
		$R_L = 2\text{k}\Omega$ to $1.35\text{V}$ , $V_O = 0.2\text{V}$ to $2.5\text{V}$	103	83 <b>77</b>	
	Large Signal Voltage Gain LMV922 (Dual) LMV924 (Quad)	$R_L = 600\Omega$ to $1.35\text{V}$ , $V_O = 0.2\text{V}$ to $2.5\text{V}$	86	68 <b>63</b>	dB min
		$R_L = 2\text{k}\Omega$ to $1.35\text{V}$ , $V_O = 0.2\text{V}$ to $2.5\text{V}$	91	71 <b>65</b>	
$V_O$	Output Swing	$R_L = 600\Omega$ to $1.35\text{V}$ $V_{\text{IN}} = \pm 100\text{mV}$	2.62	2.550 <b>2.530</b>	V min
			0.075	0.095 <b>0.115</b>	V max
		$R_L = 2\text{k}\Omega$ to $1.35\text{V}$ $V_{\text{IN}} = \pm 100\text{mV}$	2.675	2.650 <b>2.640</b>	V min
			0.025	0.040 <b>0.045</b>	V max
$I_O$	Output Short Circuit Current	Sourcing, $V_O = 0\text{V}$ $V_{\text{IN}} = 100\text{mV}$	27	20 <b>15</b>	mA min
		Sinking, $V_O = 2.7\text{V}$ $V_{\text{IN}} = -100\text{mV}$	28	22 <b>16</b>	mA min

## 2.7V AC ELECTRICAL CHARACTERISTICS

Unless otherwise specified, all limits specified for  $T_J = 25^\circ\text{C}$ .  $V^+ = 2.7\text{V}$ ,  $V^- = 0\text{V}$ ,  $V_{\text{CM}} = 1.0\text{V}$ ,  $V_O = 1.35\text{V}$  and  $R_L > 1\text{M}\Omega$ .

**Boldface** limits apply at the temperature extremes.

Symbol	Parameter	Conditions	Typ <sup>(1)</sup>	Units
SR	Slew Rate	See <sup>(2)</sup>	0.41	V/ $\mu\text{s}$
GBW	Gain-Bandwidth Product		1	MHz
$\Phi_m$	Phase Margin		65	Deg.
$G_m$	Gain Margin		10	dB
$e_n$	Input-Referred Voltage Noise	$f = 1\text{kHz}$ , $V_{\text{CM}} = 0.5\text{V}$	45	nV/ $\sqrt{\text{Hz}}$
$i_n$	Input-Referred Current Noise	$f = 1\text{kHz}$	0.1	pA/ $\sqrt{\text{Hz}}$
THD	Total Harmonic Distortion	$f = 1\text{kHz}$ , $A_V = +1$ $R_L = 600\text{k}\Omega$ , $V_{\text{IN}} = 1\text{V}_{\text{PP}}$	0.077	%
	Amp-to-Amp Isolation	See <sup>(3)</sup>	140	dB

(1) Typical Values represent the most likely parametric norm.

(2)  $V^+ = 5\text{V}$ . Connected as voltage follower with 5V step input. Number specified is the slower of the positive and negative slew rates.

(3) Input referred,  $V^+ = 5\text{V}$  and  $R_L = 100\text{k}\Omega$  connected to 2.5V. Each amp excited in turn with 1kHz to produce  $V_O = 3\text{V}_{\text{PP}}$ .

## 5V DC ELECTRICAL CHARACTERISTICS

Unless otherwise specified, all limits specified for  $T_J = 25^\circ\text{C}$ .  $V^+ = 5\text{V}$ ,  $V^- = 0\text{V}$ ,  $V_{\text{CM}} = V^+/2$ ,  $V_O = V^+/2$  and  $R_L > 1\text{M}\Omega$ . **Boldface** limits apply at the temperature extremes.

Symbol	Parameter	Condition	Typ <sup>(1)</sup>	Limits <sup>(2)</sup>	Units
$V_{\text{OS}}$	Input Offset Voltage	LMV921 (Single)	-1.5	6 <b>8</b>	mV max
		LMV922 (Dual) LMV924 (Quad)	-1.5	8 <b>9.5</b>	mV max
$\text{TCV}_{\text{OS}}$	Input Offset Voltage Average Drift		1		$\mu\text{V}/^\circ\text{C}$
$I_B$	Input Bias Current		12	35 <b>50</b>	nA max
$I_{\text{OS}}$	Input Offset Current		2	25 <b>40</b>	nA max
$I_S$	Supply Current	LMV921 (Single)	160	210 <b>230</b>	$\mu\text{A}$ max
		LMV922 (Dual)	400	500 <b>700</b>	
		LMV924 (Quad)	750	850 <b>980</b>	
CMRR	Common Mode Rejection Ratio	$0\text{V} \leq V_{\text{CM}} \leq 3.8\text{V}$	86	62 <b>61</b>	dB min
		$-0.2\text{V} \leq V_{\text{CM}} \leq 0\text{V}$ $5.0\text{V} \leq V_{\text{CM}} \leq 5.2\text{V}$	72	50	
PSRR	Power Supply Rejection Ratio	$1.8\text{V} \leq V^+ \leq 5\text{V}$ $V_{\text{CM}} = 0.5\text{V}$	78	67 <b>62</b>	dB min
$V_{\text{CM}}$	Input Common-Mode Voltage Range	For CMRR $\geq 50\text{dB}$	-0.3	-0.2 <b>0</b>	V min
			5.350	5.2 <b>5.0</b>	V max
$A_V$	Voltage Gain LMV921 (Single)	$R_L = 600\Omega$ to 2.5V $V_O = 0.2\text{V}$ to 4.8V	104	86 <b>82</b>	dB min
		$R_L = 2\text{k}\Omega$ to 2.5V $V_O = 0.2\text{V}$ to 4.8V	108	89 <b>85</b>	
	Voltage Gain LMV922 (Dual) LMV924 (Quad)	$R_L = 600\Omega$ to 2.5V $V_O = 0.2\text{V}$ to 4.8V	90	72 68	dB min
		$R_L = 2\text{k}\Omega$ to 2.5V $V_O = 0.2\text{V}$ to 4.8V	96	77 73	
$V_O$	Output Swing	$R_L = 600\Omega$ to 2.5V $V_{\text{IN}} = \pm 100\text{mV}$	4.895	4.865 <b>4.840</b>	V min
			0.1	0.135 <b>0.160</b>	V max
		$R_L = 2\text{k}\Omega$ to 2.5V $V_{\text{IN}} = \pm 100\text{mV}$	4.965	4.945 <b>4.935</b>	V min
			0.035	0.065 <b>0.075</b>	V max
$I_O$	Output Short Circuit Current	LMV921 Sourcing, $V_O = 0\text{V}$ $V_{\text{IN}} = 100\text{mV}$	98	85 <b>68</b>	mA min
		LMV922, LMV924 Sourcing, $V_O = 0\text{V}$ $V_{\text{IN}} = 100\text{mV}$	60	35	
		Sinking, $V_O = 5\text{V}$ $V_{\text{IN}} = -100\text{mV}$	75	65 <b>45</b>	mA min

(1) Typical Values represent the most likely parametric norm.

(2) All limits are specified by testing or statistical analysis.

## 5V AC ELECTRICAL CHARACTERISTICS

Unless otherwise specified, all limits specified for  $T_J = 25^\circ\text{C}$ .  $V^+ = 5\text{V}$ ,  $V^- = 0\text{V}$ ,  $V_{\text{CM}} = V^+/2$ ,  $V_O = 2.5\text{V}$  and  $R_L > 1\text{M}\Omega$ .

**Boldface** limits apply at the temperature extremes.

Symbol	Parameter	Conditions	Typ <sup>(1)</sup>	Units
SR	Slew Rate	See <sup>(2)</sup>	0.45	V/ $\mu\text{s}$
GBW	Gain-Bandwidth Product		1	MHz
$\Phi_m$	Phase Margin		70	Deg
$G_m$	Gain Margin		15	dB
$e_n$	Input-Referred Voltage Noise	$f = 1\text{ kHz}$ , $V_{\text{CM}} = 1\text{V}$	45	nV/ $\sqrt{\text{Hz}}$
$i_n$	Input-Referred Current Noise	$f = 1\text{ kHz}$	0.1	pA/ $\sqrt{\text{Hz}}$
THD	Total Harmonic Distortion	$f = 1\text{ kHz}$ , $A_V = +1$ $R_L = 600\Omega$ , $V_O = 1\text{ V}_{\text{PP}}$	0.069	%
	Amp-to-Amp Isolation	See <sup>(3)</sup>	140	dB

(1) Typical Values represent the most likely parametric norm.

(2)  $V^+ = 5\text{V}$ . Connected as voltage follower with 5V step input. Number specified is the slower of the positive and negative slew rates.

(3) Input referred,  $V^+ = 5\text{V}$  and  $R_L = 100\text{k}\Omega$  connected to 2.5V. Each amp excited in turn with 1kHz to produce  $V_O = 3\text{V}_{\text{PP}}$ .

## TYPICAL PERFORMANCE CHARACTERISTICS

Unless otherwise specified,  $V_S = +5V$ , single supply,  $T_A = 25^\circ C$ .

\*For large signal pulse response in the unity gain follower configuration, the input is 5mV below the positive rail and 5mV above the negative rail at  $25^\circ C$  and  $85^\circ C$ . At  $-40^\circ C$ , input is 10mV below the positive rail and 10mV above the negative rail.

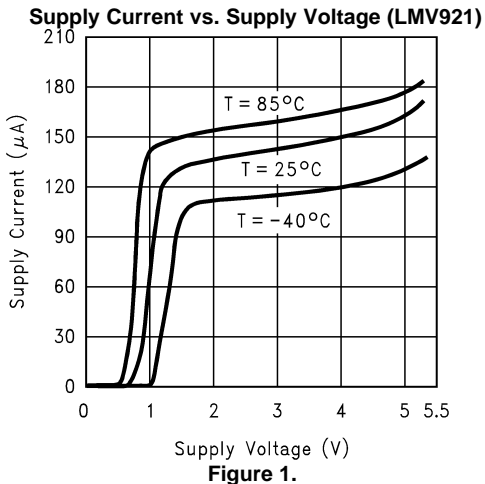

Figure 1.

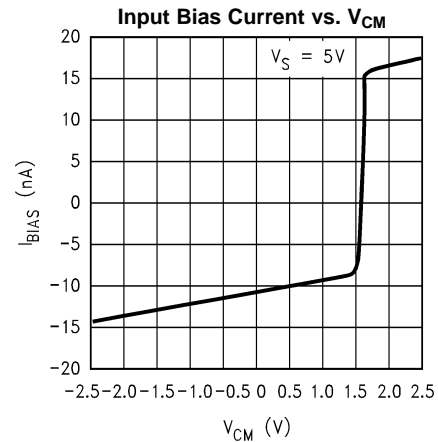

Figure 2.

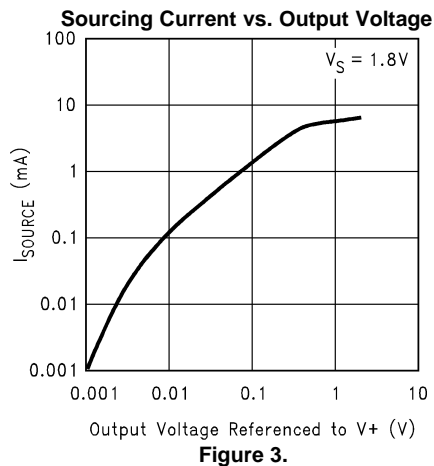

Figure 3.

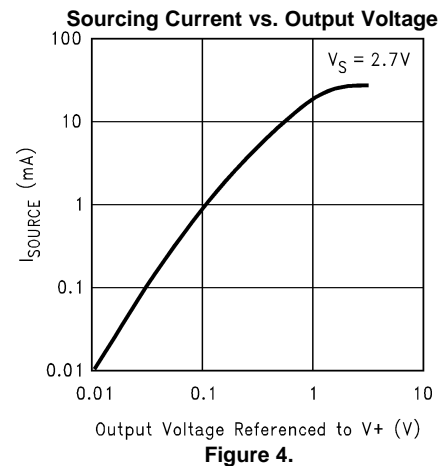

Figure 4.

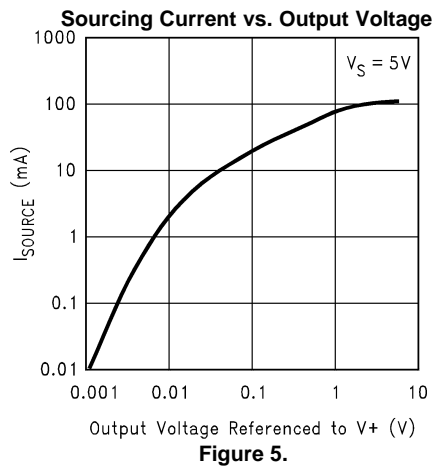

Figure 5.

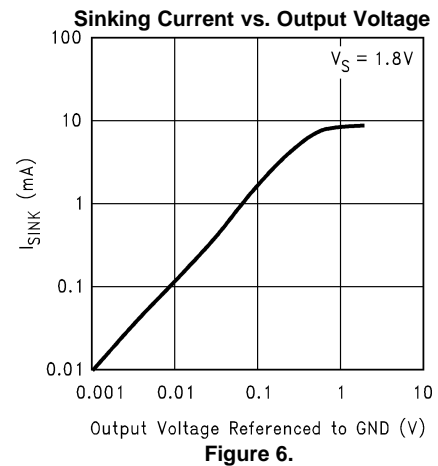
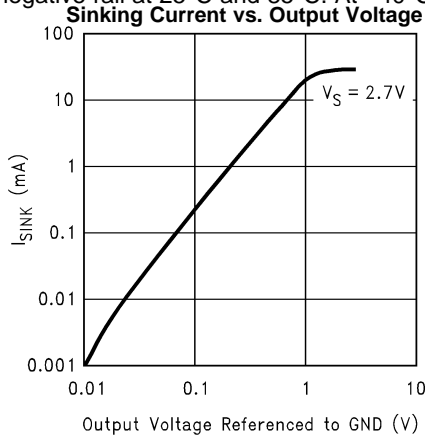

Figure 6.

**TYPICAL PERFORMANCE CHARACTERISTICS (continued)**

Unless otherwise specified,  $V_S = +5V$ , single supply,  $T_A = 25^\circ C$ .

\*For large signal pulse response in the unity gain follower configuration, the input is 5mV below the positive rail and 5mV above the negative rail at 25°C and 85°C. At -40°C, input is 10mV below the positive rail and 10mV above the negative rail.



**Figure 7.**

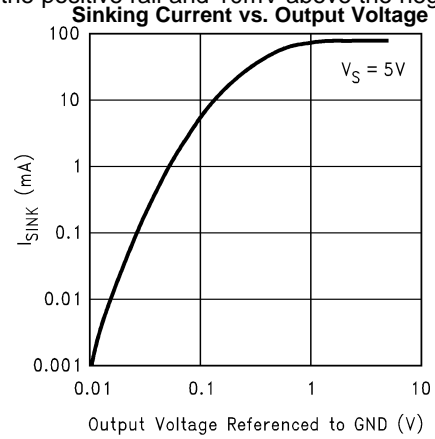

**Figure 8.**

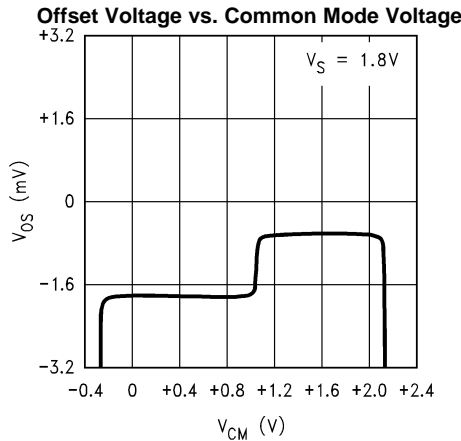

**Figure 9.**

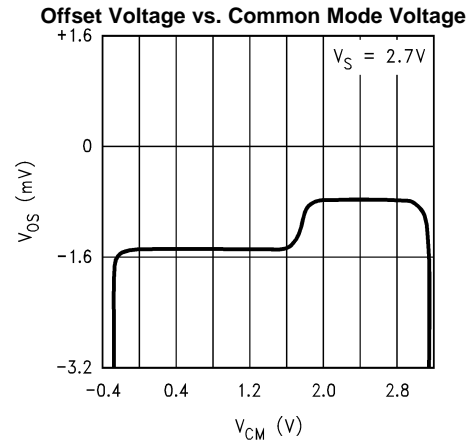

**Figure 10.**

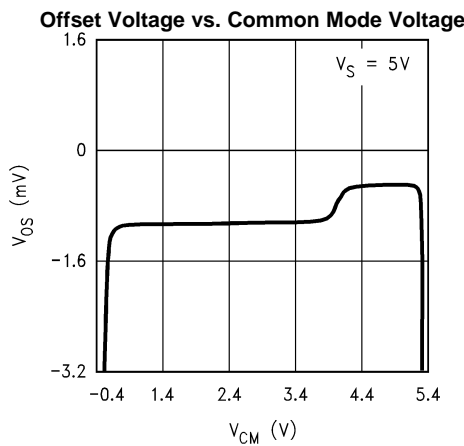

**Figure 11.**

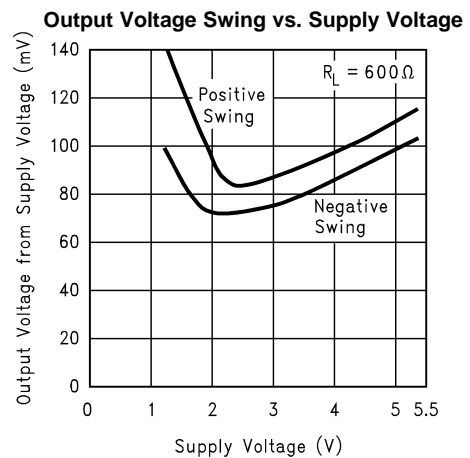

**Figure 12.**

**TYPICAL PERFORMANCE CHARACTERISTICS (continued)**

Unless otherwise specified,  $V_S = +5V$ , single supply,  $T_A = 25^\circ C$ .

\*For large signal pulse response in the unity gain follower configuration, the input is 5mV below the positive rail and 5mV above the negative rail at  $25^\circ C$  and  $85^\circ C$ . At  $-40^\circ C$ , input is 10mV below the positive rail and 10mV above the negative rail.

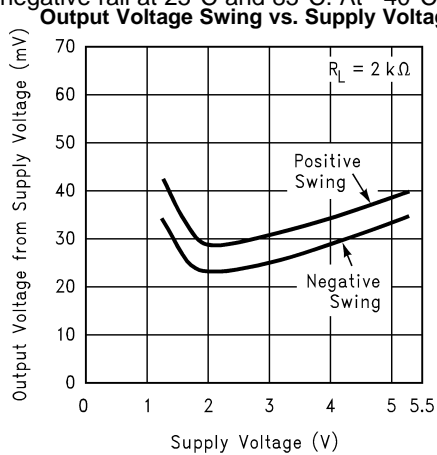

Figure 13.

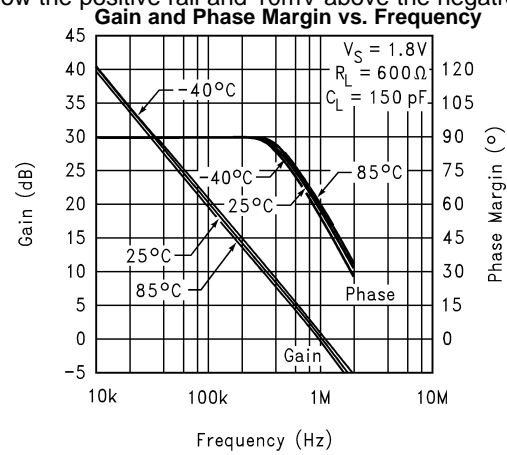

Figure 14.

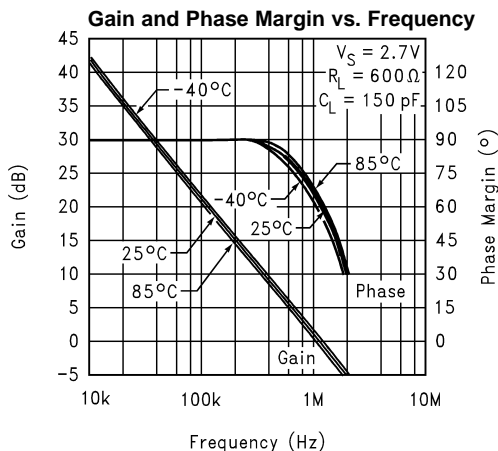

Figure 15.

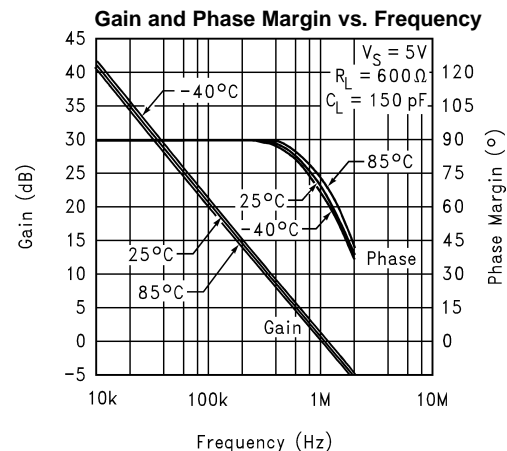

Figure 16.

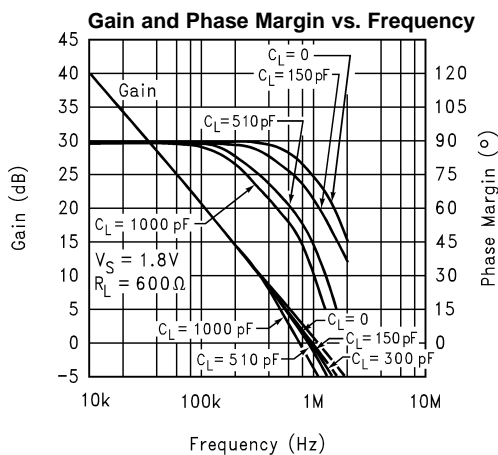

Figure 17.

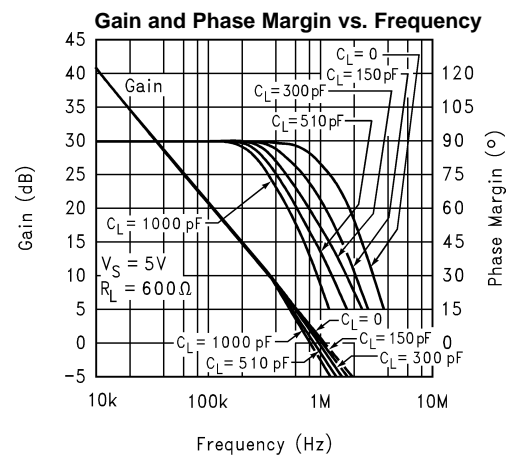
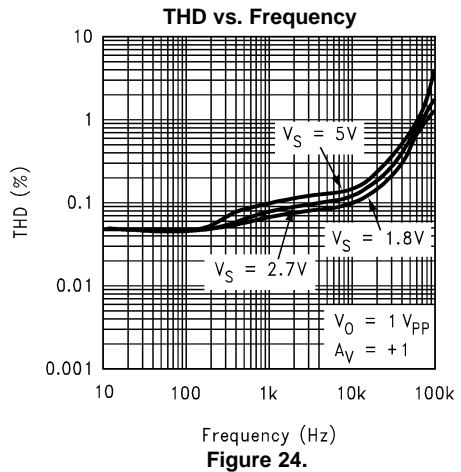
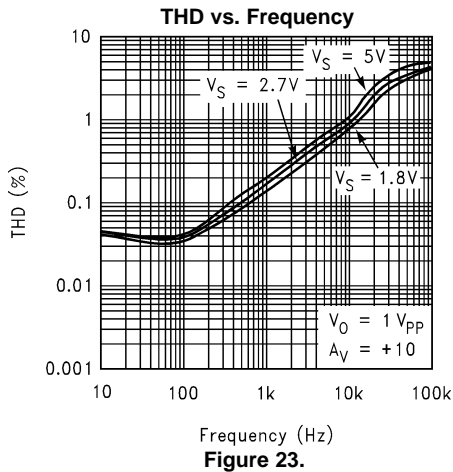
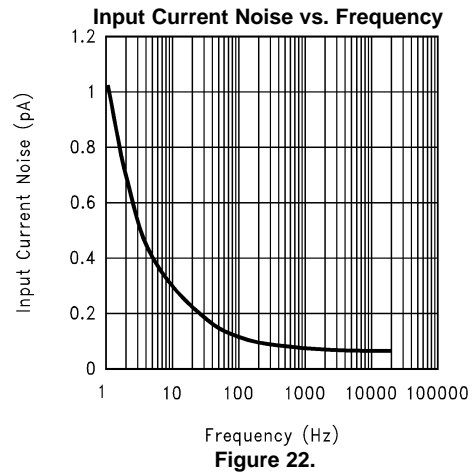
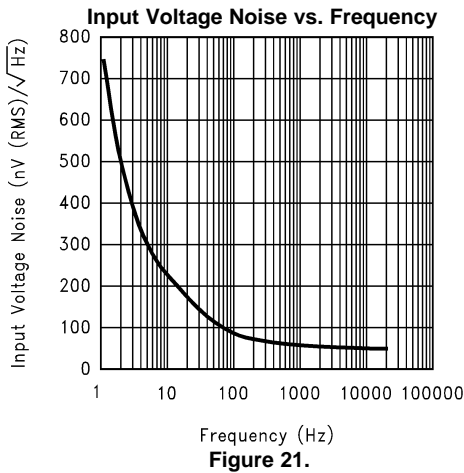
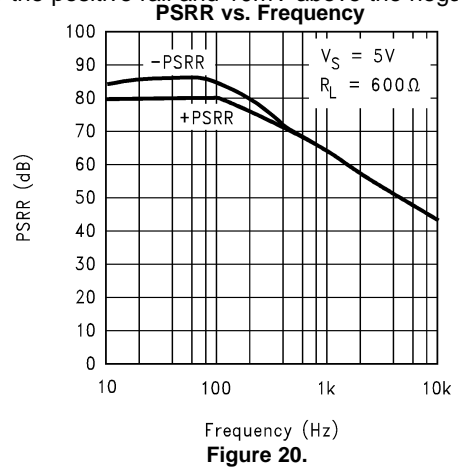
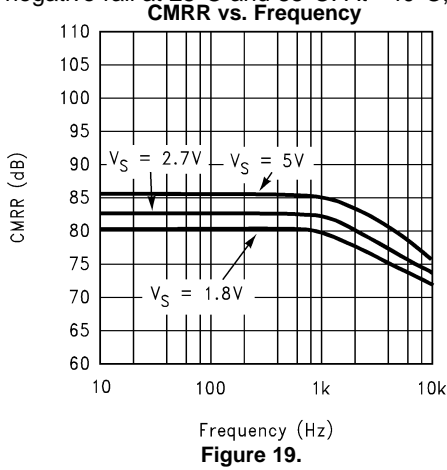

Figure 18.

**TYPICAL PERFORMANCE CHARACTERISTICS (continued)**

Unless otherwise specified,  $V_S = +5V$ , single supply,  $T_A = 25^\circ C$ .

\*For large signal response in the unity gain follower configuration, the input is 5mV below the positive rail and 5mV above the negative rail at  $25^\circ C$  and  $85^\circ C$ . At  $-40^\circ C$ , input is 10mV below the positive rail and 10mV above the negative rail.



## TYPICAL PERFORMANCE CHARACTERISTICS (continued)

Unless otherwise specified,  $V_S = +5V$ , single supply,  $T_A = 25^\circ C$ .

\*For large signal pulse response in the unity gain follower configuration, the input is 5mV below the positive rail and 5mV above the negative rail at  $25^\circ C$  and  $85^\circ C$ . At  $-40^\circ C$ , input is 10mV below the positive rail and 10mV above the negative rail.

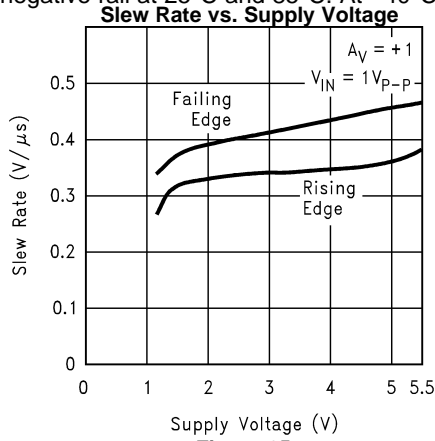

Figure 25.

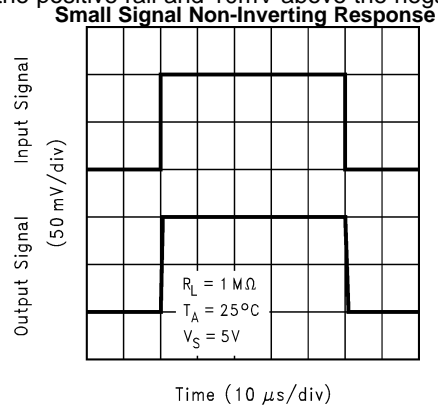

Figure 26.

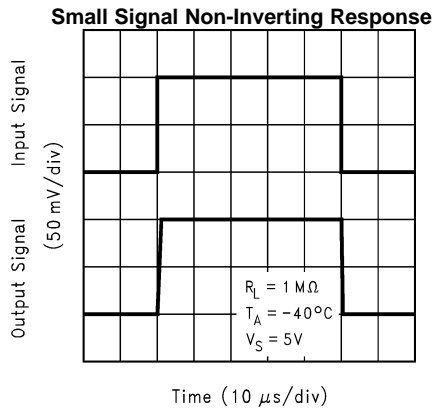

Figure 27.

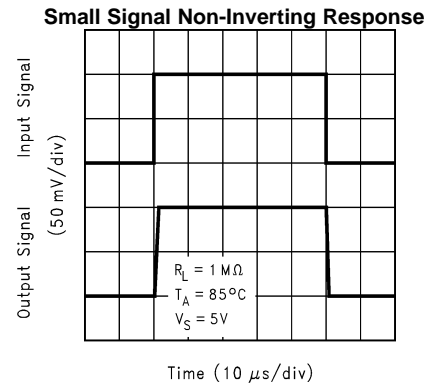

Figure 28.

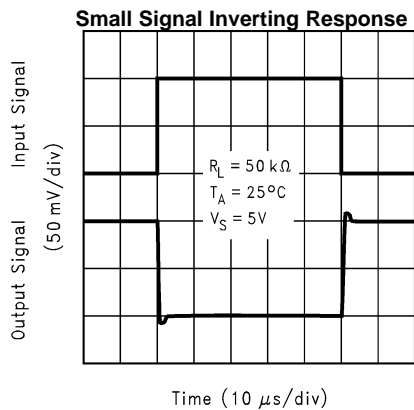

Figure 29.

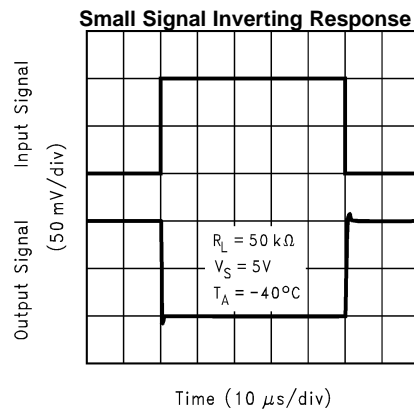
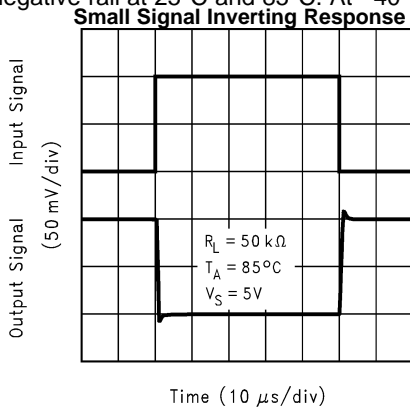

Figure 30.

**TYPICAL PERFORMANCE CHARACTERISTICS (continued)**

Unless otherwise specified,  $V_S = +5V$ , single supply,  $T_A = 25^\circ C$ .

\*For large signal pulse response in the unity gain follower configuration, the input is 5mV below the positive rail and 5mV above the negative rail at 25°C and 85°C. At -40°C, input is 10mV below the positive rail and 10mV above the negative rail.



**Figure 31.**

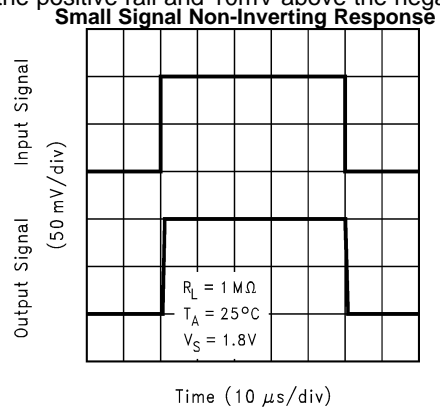

**Figure 32.**

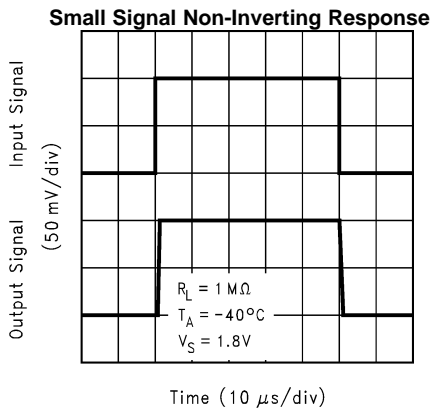

**Figure 33.**

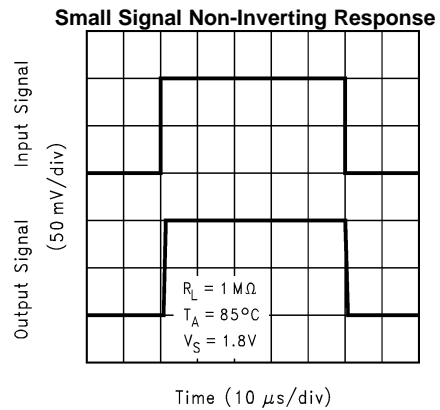

**Figure 34.**

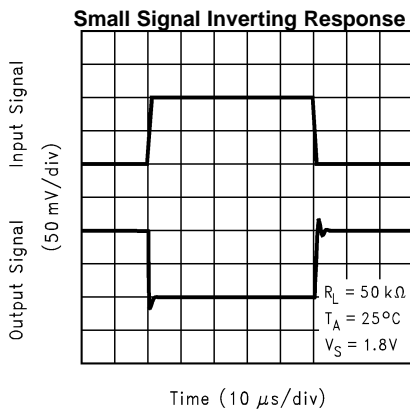

**Figure 35.**

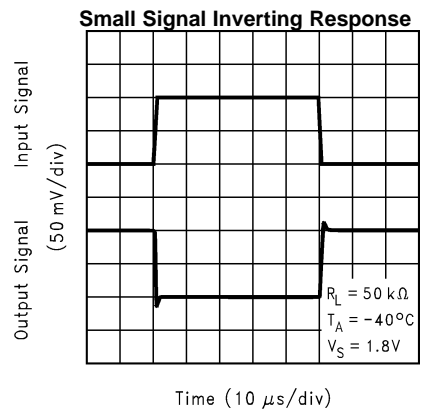

**Figure 36.**

### TYPICAL PERFORMANCE CHARACTERISTICS (continued)

Unless otherwise specified,  $V_S = +5V$ , single supply,  $T_A = 25^\circ C$ .

\*For large signal pulse response in the unity gain follower configuration, the input is 5mV below the positive rail and 5mV above the negative rail at  $25^\circ C$  and  $85^\circ C$ . At  $-40^\circ C$ , input is 10mV below the positive rail and 10mV above the negative rail.

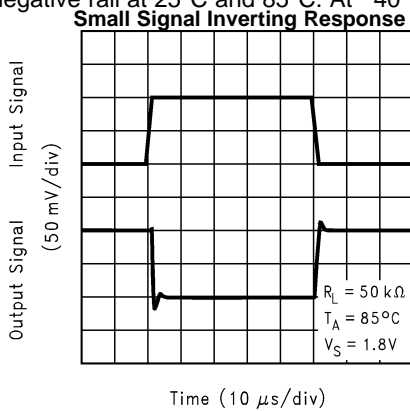

Figure 37.

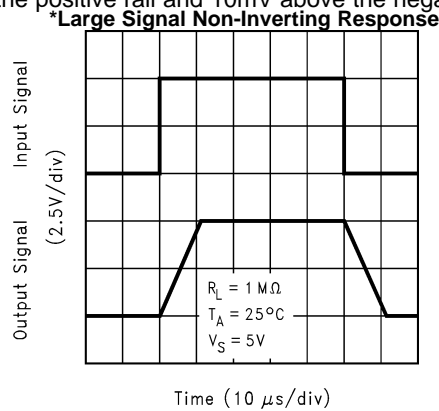

Figure 38.

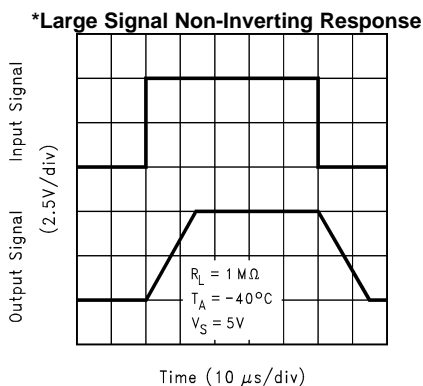

Figure 39.

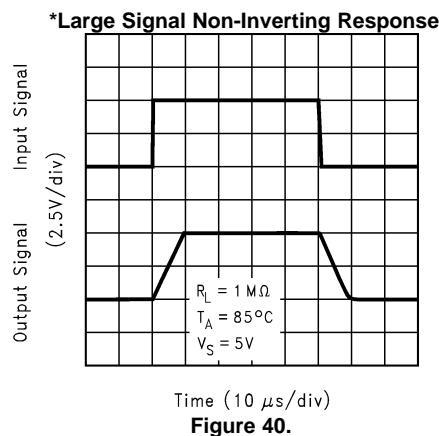

Figure 40.

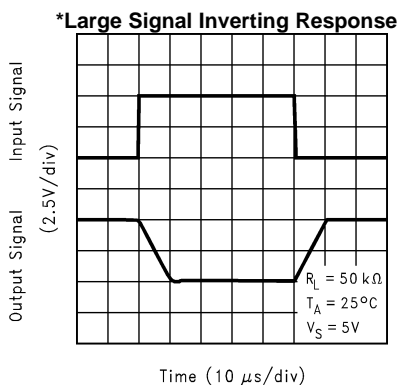

Figure 41.

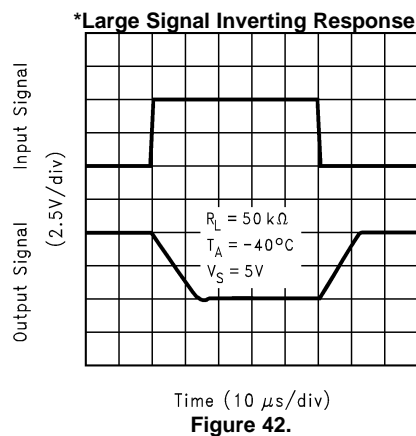
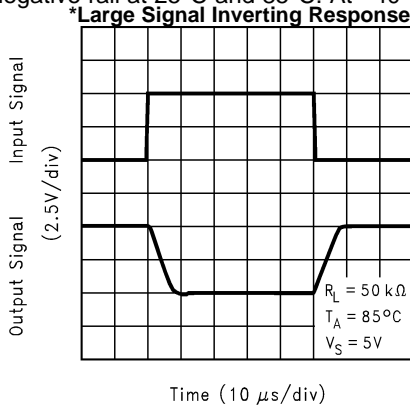

Figure 42.

**TYPICAL PERFORMANCE CHARACTERISTICS (continued)**

Unless otherwise specified,  $V_S = +5V$ , single supply,  $T_A = 25^\circ C$ .

\*For large signal pulse response in the unity gain follower configuration, the input is 5mV below the positive rail and 5mV above the negative rail at  $25^\circ C$  and  $85^\circ C$ . At  $-40^\circ C$ , input is 10mV below the positive rail and 10mV above the negative rail.



**Figure 43.**

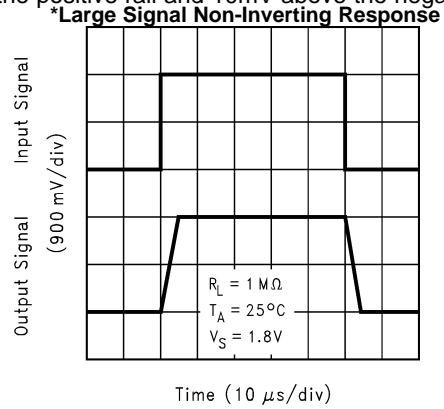

**Figure 44.**

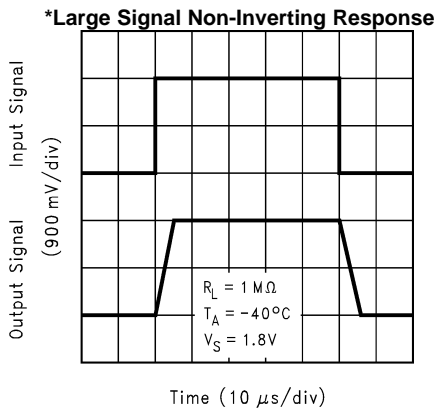

**Figure 45.**

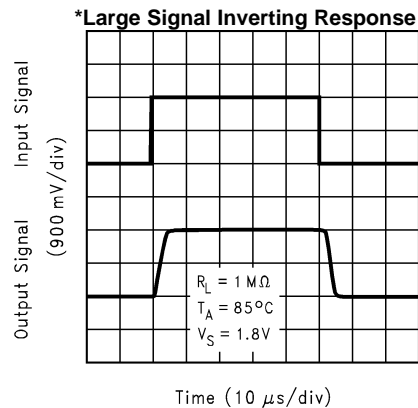

**Figure 46.**

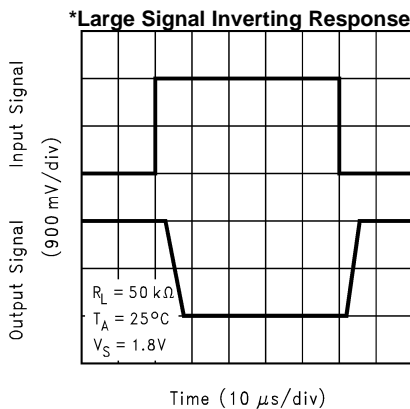

**Figure 47.**

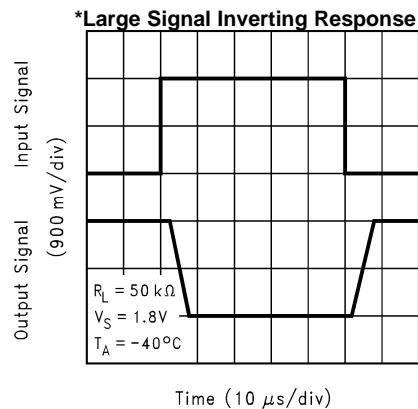

**Figure 48.**

### TYPICAL PERFORMANCE CHARACTERISTICS (continued)

Unless otherwise specified,  $V_S = +5V$ , single supply,  $T_A = 25^\circ C$ .

\*For large signal pulse response in the unity gain follower configuration, the input is 5mV below the positive rail and 5mV above the negative rail at  $25^\circ C$  and  $85^\circ C$ . At  $-40^\circ C$ , input is 10mV below the positive rail and 10mV above the negative rail.

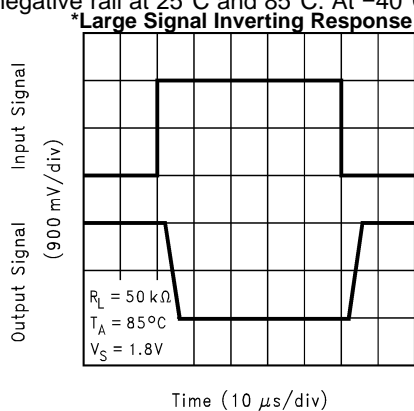

Figure 49.

### Short Circuit Current vs. Temperature (sinking)

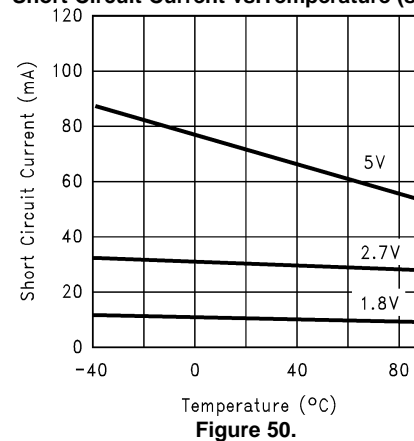

Figure 50.

### Short Circuit Current vs. Temperature (sourcing)

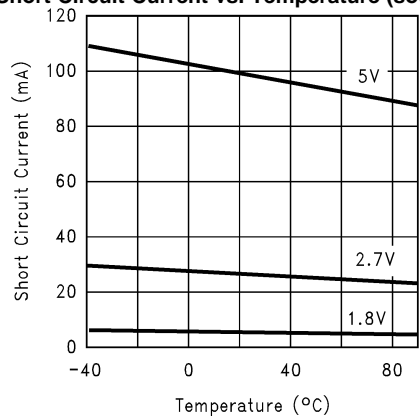
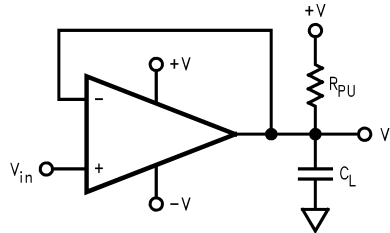

Figure 51.

## APPLICATION NOTE

### Unity Gain Pulse Response Considerations

The unity-gain follower is the most sensitive configuration to capacitive loading. The LMV921/LMV922/LMV924 family can directly drive 1nF in a unity-gain with minimal ringing. Direct capacitive loading reduces the phase margin of the amplifier. The combination of the amplifier's output impedance and the capacitive load induces phase lag. This results in either an underdamped pulse response or oscillation. The pulse response can be improved by adding a pull up resistor as shown in [Figure 52](#)



**Figure 52. Using a Pull-Up Resistor at the Output for Stabilizing Capacitive Loads**

Higher capacitances can be driven by decreasing the value of the pull-up resistor, but its value shouldn't be reduced beyond the sinking capability of the part. An alternate approach is to use an isolation resistor as illustrated in [Figure 53](#).

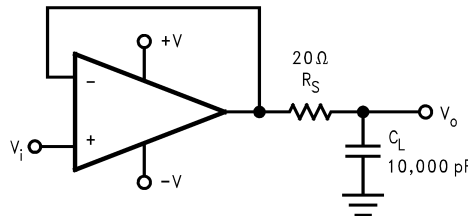

**Figure 53. Using an Isolation Resistor to Drive Heavy Capacitive Loads**

### Input Bias Current Consideration

The LMV921/LMV922/LMV924 family has a bipolar input stage. The typical input bias current ( $I_B$ ) is 12nA. The input bias current can develop a significant offset voltage. This offset is primarily due to  $I_B$  flowing through the negative feedback resistor,  $R_F$ . For example, if  $I_B$  is 50nA (max room) and  $R_F$  is 100k $\Omega$ , then an offset voltage of 5mV will develop ( $V_{OS} = I_B \times R_F$ ). Using a compensation resistor ( $R_C$ ), as shown in [Figure 54](#), cancels this affect. But the input offset current ( $I_{OS}$ ) will still contribute to an offset voltage in the same manner.

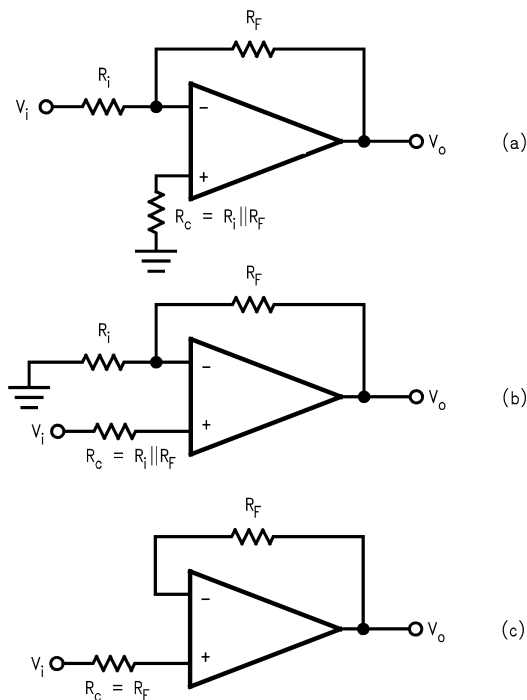

**Figure 54. Canceling the Voltage Offset Effect of Input Bias Current**

### Operating Supply Voltage

The LMV921/LMV922/LMV924 family is ensured to operate from 1.8V to 5.0V. They will begin to function at power voltages as low as 1.2V at room temperature when unloaded. Start up voltage increases to 1.5V when the amplifier is fully loaded (600Ω to mid-supply). Below 1.2V the output voltage is not ensured to follow the input. [Figure 55](#) below shows the output voltage vs. supply voltage with the LMV921/LMV922/LMV924 configured as a voltage follower at room temperature.

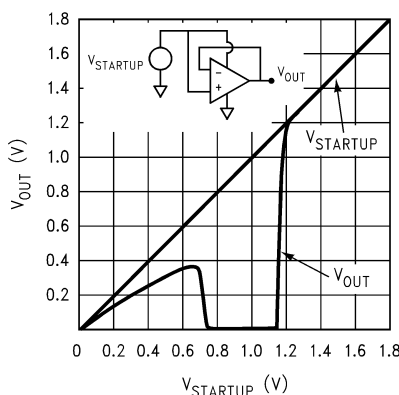

**Figure 55. Output Voltage vs. Supply Voltage**

### Input and Output Stage

The rail-to-rail input stage of this family provides more flexibility for the designer. The LMV921/LMV922/LMV924 use a complimentary PNP and NPN input stage in which the PNP stage senses common mode voltage near  $V^-$  and the NPN stage senses common mode voltage near  $V^+$ . The transition from the PNP stage to NPN stage occurs 1V below  $V^+$ . Since both input stages have their own offset voltage, the offset of the amplifier becomes a function of the input common mode voltage and has a crossover point at 1V below  $V^+$  as shown in the  $V_{OS}$  vs.  $V_{CM}$  curves.

This  $V_{OS}$  crossover point can create problems for both DC and AC coupled signals if proper care is not taken. For large input signals that include the  $V_{OS}$  crossover point in their dynamic range, this will cause distortion in the output signal. One way to avoid such distortion is to keep the signal away from the crossover. For example, in a unity gain buffer configuration and with  $V_S = 5V$ , a 5V peak-to-peak signal will contain input-crossover distortion while a 3V peak-to-peak signal centered at 1.5V will not contain input-crossover distortion as it avoids the crossover point. Another way to avoid large signal distortion is to use a gain of  $-1$  circuit which avoids any voltage excursions at the input terminals of the amplifier. In that circuit, the common mode DC voltage can be set at a level away from the  $V_{OS}$  cross-over point.

For small signals, this transition in  $V_{OS}$  shows up as a  $V_{CM}$  dependent spurious signal in series with the input signal and can effectively degrade small signal parameters such as gain and common mode rejection ratio. To resolve this problem, the small signal should be placed such that it avoids the  $V_{OS}$  crossover point.

In addition to the rail-to-rail performance, the output stage can provide enough output current to drive 600 $\Omega$  loads. Because of the high current capability, care should be taken not to exceed the 150°C maximum junction temperature specification.

## Power-Supply Considerations

The LMV921/LMV922/LMV924 are ideally suited for use with most battery-powered systems. The LMV921/LMV922/LMV924 operate from a single +1.8V to +5.0V supply and consumes about 145 $\mu$ A of supply current per Amplifier. A high power supply rejection ratio of 78dB allows the amplifier to be powered directly off a decaying battery voltage extending battery life.

[Table 1](#) lists a variety of typical battery types. Batteries have different voltage ratings; operating voltage is the battery voltage under nominal load. End-of-Life voltage is defined as the voltage at which 100% of the usable power of the battery is consumed. [Table 1](#) also shows the typical operating time of the LMV921.

## Distortion

The two main contributors of distortion in LMV921/LMV922/LMV924 family is:

1. Output crossover distortion occurs as the output transitions from sourcing current to sinking current.
2. Input crossover distortion occurs as the input switches from NPN to PNP transistor at the input stage.

To decrease crossover distortion:

1. Increase the load resistance. This lowers the output crossover distortion but has no effect on the input crossover distortion.
2. Operate from a single supply with the output always sourcing current.
3. Limit the input voltage swing for large signals between ground and one volt below the positive supply.
4. Operate in inverting configuration to eliminate common mode induced distortion.
5. Avoid small input signal around the input crossover region. The discontinuity in the offset voltage will effect the gain, CMRR and PSRR.

**Table 1. LMV921 Characteristics with Typical Battery Systems.**

Battery Type	Operating Voltage (V)	End-of-Life Voltage (V)	Capacity AA Size (mA - h)	LMV921 Operating time (Hours)
Alkaline	1.5	0.9	1000	6802
Lithium	2.7	2.0	1000	6802
Ni - Cad	1.2	0.9	375	2551
NMH	1.2	1.0	500	3401

## TYPICAL APPLICATIONS

### Half-wave Rectifier with Rail-To-Ground Output Swing

Since the LMV921 input common mode range includes both positive and negative supply rails and the output can also swing to either supply, achieving half-wave rectifier functions in either direction is an easy task. All that is needed are two external resistors; there is no need for diodes or matched resistors. The half wave rectifier can have either positive or negative going outputs, depending on the way the circuit is arranged.

In [Figure 56](#) the circuit is referenced to ground, while in [Figure 57](#) the circuit is biased to the positive supply. These configurations implement the half wave rectifier since the LMV921 can not respond to one-half of the incoming waveform. It can not respond to one-half of the incoming because the amplifier can not swing the output beyond either rail therefore the output disengages during this half cycle. During the other half cycle, however, the amplifier achieves a half wave that can have a peak equal to the total supply voltage.  $R_1$  should be large enough not to load the LMV921.

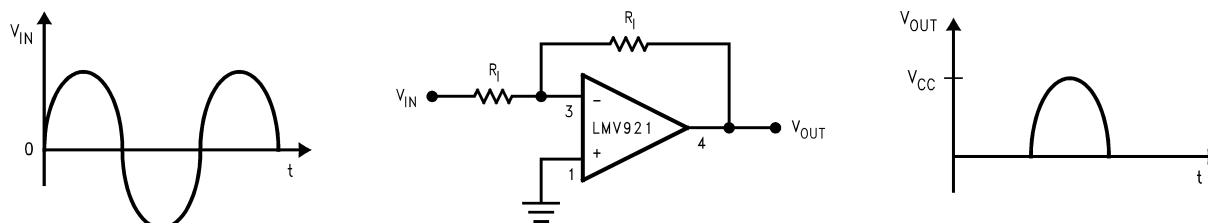

**Figure 56. Half-Wave Rectifier with Rail-To-Ground Output Swing Referenced to Ground**

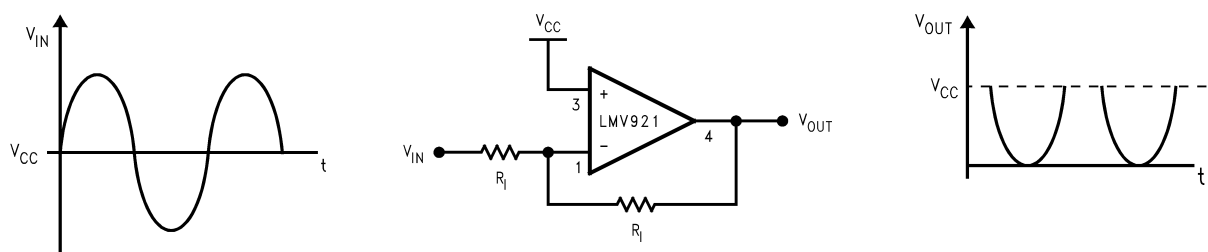

**Figure 57. Half-Wave Rectifier with Negative-Going Output Referenced to  $V_{CC}$**

### Instrumentation Amplifier with Rail-To-Rail Input and Output

Using three of the LMV924 Amplifiers, an instrumentation amplifier with rail-to-rail inputs and outputs can be made.

Some manufacturers use a precision voltage divider array of 5 resistors to divide the common mode voltage to get a rail-to-rail input range. The problem with this method is that it also divides the signal, so in order to get unity gain, the amplifier must be run at high loop gains. This raises the noise and drift by the internal gain factor and lowers the input impedance. Any mismatch in these precision resistors reduces the CMRR as well. Using the LMV924 eliminates all of these problems.

In this example, amplifiers A and B act as buffers to the differential stage. These buffers assure that the input impedance is very high and require no precision matched resistors in the input stage. They also assure that the difference amp is driven from a voltage source. This is necessary to maintain the CMRR set by the matching  $R_1$ - $R_2$  with  $R_3$ - $R_4$ .

The gain is set by the ratio of  $R_2/R_1$  and  $R_3$  should equal  $R_1$  and  $R_4$  equal  $R_2$ .

With both rail-to-rail input and output ranges, the input and output are only limited by the supply voltages. Remember that even with rail-to-rail outputs, the output can not swing past the supplies so the combined common mode voltages plus the signal should not be greater than the supplies or limiting will occur. For additional applications, see TI application notes [AN-29](#), [AN-31](#), [AN-71](#), and [AN-127](#).

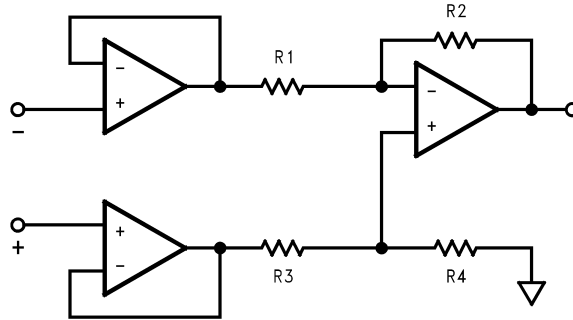
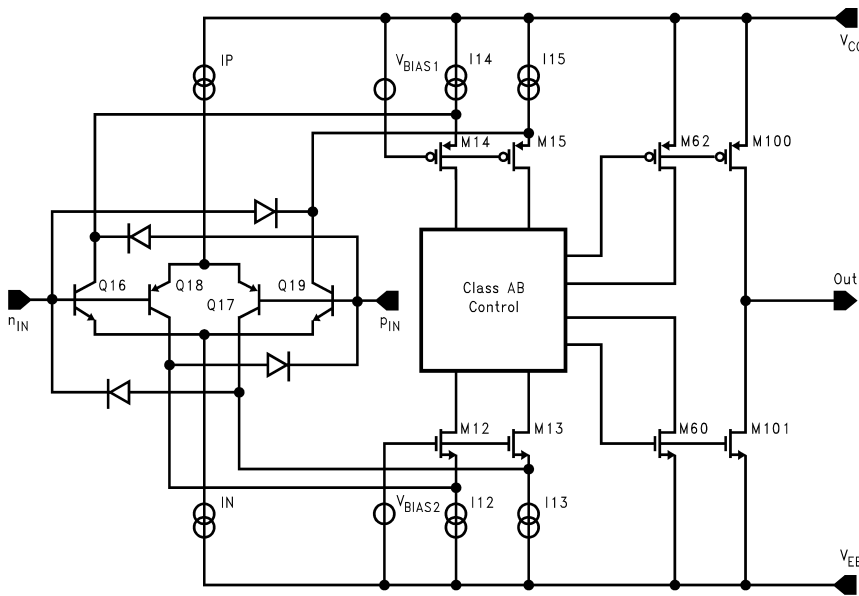

Figure 58. Rail-to-rail instrumentation amplifier

Simplified Schematic



Connection Diagrams

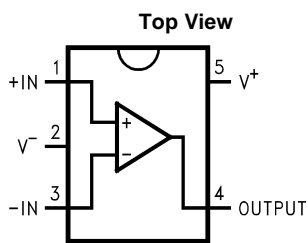

Figure 59. 5-Pin SC70-5/SOT-23-5 Package

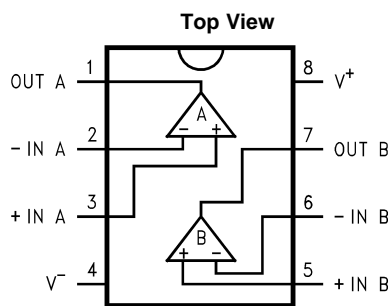

Figure 60. 8-Pin VSSOP/SOIC Package

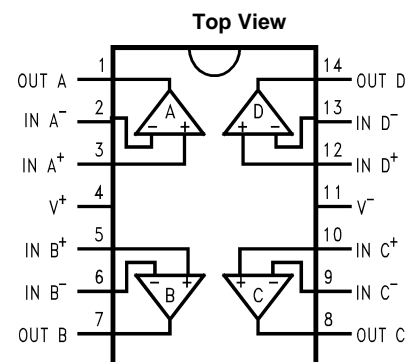

Figure 61. 14-Pin TSSOP/SOIC Package

## REVISION HISTORY

Changes from Revision G (April 2013) to Revision H	Page
• Changed layout of National Data Sheet to TI format .....	<a href="#">21</a>

## IMPORTANT NOTICE

Texas Instruments Incorporated and its subsidiaries (TI) reserve the right to make corrections, enhancements, improvements and other changes to its semiconductor products and services per JESD46, latest issue, and to discontinue any product or service per JESD48, latest issue. Buyers should obtain the latest relevant information before placing orders and should verify that such information is current and complete. All semiconductor products (also referred to herein as "components") are sold subject to TI's terms and conditions of sale supplied at the time of order acknowledgment.

TI warrants performance of its components to the specifications applicable at the time of sale, in accordance with the warranty in TI's terms and conditions of sale of semiconductor products. Testing and other quality control techniques are used to the extent TI deems necessary to support this warranty. Except where mandated by applicable law, testing of all parameters of each component is not necessarily performed.

TI assumes no liability for applications assistance or the design of Buyers' products. Buyers are responsible for their products and applications using TI components. To minimize the risks associated with Buyers' products and applications, Buyers should provide adequate design and operating safeguards.

TI does not warrant or represent that any license, either express or implied, is granted under any patent right, copyright, mask work right, or other intellectual property right relating to any combination, machine, or process in which TI components or services are used. Information published by TI regarding third-party products or services does not constitute a license to use such products or services or a warranty or endorsement thereof. Use of such information may require a license from a third party under the patents or other intellectual property of the third party, or a license from TI under the patents or other intellectual property of TI.

Reproduction of significant portions of TI information in TI data books or data sheets is permissible only if reproduction is without alteration and is accompanied by all associated warranties, conditions, limitations, and notices. TI is not responsible or liable for such altered documentation. Information of third parties may be subject to additional restrictions.

Resale of TI components or services with statements different from or beyond the parameters stated by TI for that component or service voids all express and any implied warranties for the associated TI component or service and is an unfair and deceptive business practice. TI is not responsible or liable for any such statements.

Buyer acknowledges and agrees that it is solely responsible for compliance with all legal, regulatory and safety-related requirements concerning its products, and any use of TI components in its applications, notwithstanding any applications-related information or support that may be provided by TI. Buyer represents and agrees that it has all the necessary expertise to create and implement safeguards which anticipate dangerous consequences of failures, monitor failures and their consequences, lessen the likelihood of failures that might cause harm and take appropriate remedial actions. Buyer will fully indemnify TI and its representatives against any damages arising out of the use of any TI components in safety-critical applications.

In some cases, TI components may be promoted specifically to facilitate safety-related applications. With such components, TI's goal is to help enable customers to design and create their own end-product solutions that meet applicable functional safety standards and requirements. Nonetheless, such components are subject to these terms.

No TI components are authorized for use in FDA Class III (or similar life-critical medical equipment) unless authorized officers of the parties have executed a special agreement specifically governing such use.

Only those TI components which TI has specifically designated as military grade or "enhanced plastic" are designed and intended for use in military/aerospace applications or environments. Buyer acknowledges and agrees that any military or aerospace use of TI components which have **not** been so designated is solely at the Buyer's risk, and that Buyer is solely responsible for compliance with all legal and regulatory requirements in connection with such use.

TI has specifically designated certain components as meeting ISO/TS16949 requirements, mainly for automotive use. In any case of use of non-designated products, TI will not be responsible for any failure to meet ISO/TS16949.

### Products

Audio	<a href="http://www.ti.com/audio">www.ti.com/audio</a>
Amplifiers	<a href="http://amplifier.ti.com">amplifier.ti.com</a>
Data Converters	<a href="http://dataconverter.ti.com">dataconverter.ti.com</a>
DLP® Products	<a href="http://www.dlp.com">www.dlp.com</a>
DSP	<a href="http://dsp.ti.com">dsp.ti.com</a>
Clocks and Timers	<a href="http://www.ti.com/clocks">www.ti.com/clocks</a>
Interface	<a href="http://interface.ti.com">interface.ti.com</a>
Logic	<a href="http://logic.ti.com">logic.ti.com</a>
Power Mgmt	<a href="http://power.ti.com">power.ti.com</a>
Microcontrollers	<a href="http://microcontroller.ti.com">microcontroller.ti.com</a>
RFID	<a href="http://www.ti-rfid.com">www.ti-rfid.com</a>
OMAP Applications Processors	<a href="http://www.ti.com/omap">www.ti.com/omap</a>
Wireless Connectivity	<a href="http://www.ti.com/wirelessconnectivity">www.ti.com/wirelessconnectivity</a>

### Applications

Automotive and Transportation	<a href="http://www.ti.com/automotive">www.ti.com/automotive</a>
Communications and Telecom	<a href="http://www.ti.com/communications">www.ti.com/communications</a>
Computers and Peripherals	<a href="http://www.ti.com/computers">www.ti.com/computers</a>
Consumer Electronics	<a href="http://www.ti.com/consumer-apps">www.ti.com/consumer-apps</a>
Energy and Lighting	<a href="http://www.ti.com/energy">www.ti.com/energy</a>
Industrial	<a href="http://www.ti.com/industrial">www.ti.com/industrial</a>
Medical	<a href="http://www.ti.com/medical">www.ti.com/medical</a>
Security	<a href="http://www.ti.com/security">www.ti.com/security</a>
Space, Avionics and Defense	<a href="http://www.ti.com/space-avionics-defense">www.ti.com/space-avionics-defense</a>
Video and Imaging	<a href="http://www.ti.com/video">www.ti.com/video</a>

### TI E2E Community

[e2e.ti.com](http://e2e.ti.com)

## Looking for pricing, stock, or lifecycle information?

Click below to explore more details on WIN SOURCE:

 [View LMV924MTX on WIN SOURCE](#)

 [Texas Instruments](#) Information

## Optimize Your Supply Chain with WIN SOURCE Solutions

-  Global Sourcing Solution
-  Obsolete Management
-  Cost Control Management
-  Shortage Management
-  Alternative Solution
-  Excess Inventory Management