



**THE DATASHEET OF  
LMN400E01-7**



**400mA LOAD SWITCH FEATURING PRE-BIASED PNP TRANSISTOR AND ESD PROTECTED N-MOSFET**
**Features**

- Voltage Controlled Small Signal Switch
- N-MOSFET with ESD Gate Protection
- Ideally Suited for Automated Assembly Processes
- **Lead Free By Design/ROHS Compliant (Note 1)**
- **"Green" Device (Note 2)**

**Description**

LMN400E01 is best suited for applications where the load needs to be turned on and off using control circuits like micro-controllers, comparators etc. particularly at a point of load. It features a discrete pass transistor with stable  $V_{CE(SAT)}$  which does not depend on input voltage and can support continuous maximum current of 400 mA. It also contains an ESD protected discrete N-MOSFET that can be used as control. The component can be used as a part of a circuit or as a stand alone discrete device.

**Mechanical Data**

- Case: SOT363
- Case Material: Molded Plastic. "Green Molding" Compound. UL Flammability Classification Rating 94V-0
- Moisture Sensitivity: Level 1 per J-STD-020C
- Terminal Connections: See Diagram
- Terminals: Finish - Matte Tin annealed over Alloy 42 leadframe. Solderable per MIL-STD-202, Method 208
- Marking Information: See Page 8
- Ordering Information: See Page 8
- Weight: 0.006 grams (approximate)

Reference	Device Type	R1(NOM)	R2(NOM)	Figure
Q1	PNP Transistor	10K	220	2
Q2	N-MOSFET	—	—	2

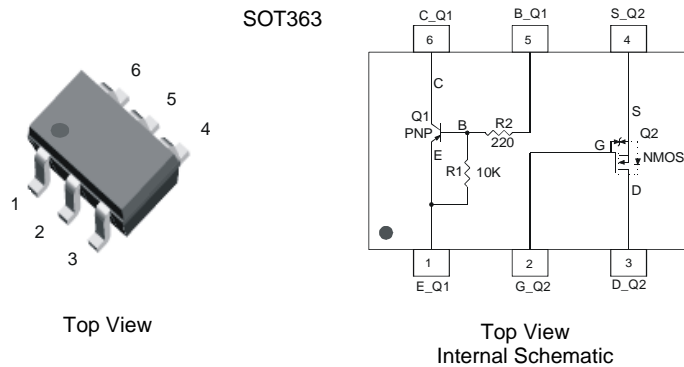
**Ordering Information (Note 3)**

Device	Packaging	Shipping
LMN400E01-7	SOT363	3000/Tape & Reel

- Notes:
1. No purposefully added lead.
  2. Diodes Inc.'s "Green" policy can be found on our website at <http://www.diodes.com>.
  3. For packaging details, go to our website at <http://www.diodes.com>.

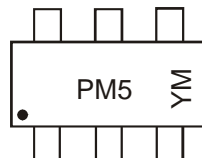
**Marking Information**

PM5 = Product Type Marking Code,  
 YM = Date Code Marking  
 Y = Year, e.g., Y = 2011  
 M = Month, e.g., 9 = September

**Date Code Key**

Year	2006	2007	2008	2009	2010	2011	2012	2013
Code	T	U	V	W	X	Y	Z	A

Month	Jan	Feb	Mar	Apr	May	Jun	Jul	Aug	Sep	Oct	Nov	Dec
Code	1	2	3	4	5	6	7	8	9	O	N	D

**Maximum Ratings, Total Device** @ $T_A = 25^\circ\text{C}$  unless otherwise specified

Characteristic	Symbol	Value	Unit
Power Dissipation (Note 4)	$P_D$	200	mW
Power Derating Factor above $37.5^\circ\text{C}$	$P_{\text{der}}$	1.6	mW/ $^\circ\text{C}$
Output Current	$I_{\text{out}}$	400	mA

**Thermal Characteristics** @ $T_A = 25^\circ\text{C}$  unless otherwise specified

Characteristic	Symbol	Value	Unit
Operating and Storage Temperature Range	$T_j, T_{\text{STG}}$	-55 to +150	$^\circ\text{C}$
Thermal Resistance, Junction to Ambient Air (Note 4)	$R_{\theta\text{JA}}$	625	$^\circ\text{C/W}$

**Maximum Ratings:  
Pre-Biased PNP Transistor (Q1)** @ $T_A = 25^\circ\text{C}$  unless otherwise specified

Characteristic	Symbol	Value	Unit
Collector-Base Voltage	$V_{\text{CBO}}$	-50	V
Collector-Emitter Voltage	$V_{\text{CEO}}$	-50	V
Supply Voltage	$V_{\text{CC}}$	-50	V
Input Voltage	$V_{\text{in}}$	-6 to +5	V
Output Current	$I_{\text{C}}$	-400	mA

**Maximum Ratings:  
ESD Protected N-Channel MOSFET (Q2)** @ $T_A = 25^\circ\text{C}$  unless otherwise specified

Characteristic	Symbol	Value	Unit
Drain-Source Voltage	$V_{\text{DSS}}$	60	V
Drain Gate Voltage ( $R_{\text{GS}} \leq 1\text{M Ohm}$ )	$V_{\text{DGR}}$	60	V
Gate-Source Voltage	$V_{\text{GSS}}$	Continuous	+/-20
		Pulsed ( $t_p < 50 \mu\text{s}$ )	+/-40
Drain Current (Note 4)	$I_{\text{D}}$	Continuous ( $V_{\text{GS}} = 10\text{V}$ )	300
		Pulsed ( $t_p < 10 \mu\text{s}$ , Duty Cycle $< 1\%$ )	800
Continuous Source Current	$I_{\text{S}}$	300	mA

Notes: 4. Device mounted on FR-4 PCB, 1 inch x 0.85 inch x 0.062 inch; pad layout as shown on Diodes Inc. suggested pad layout document AP02001, which can be found on our website at <http://www.diodes.com/datasheets/ap02001.pdf>.

**Electrical Characteristics: Pre-Biased PNP Transistor (Q1)** @T<sub>A</sub> = 25°C unless otherwise specified

Characteristic	Symbol	Min	Typ	Max	Unit	Test Condition
<b>OFF CHARACTERISTICS (Note 5)</b>						
Collector-Base Cut Off Current	I <sub>CBO</sub>	—	—	-500	nA	V <sub>CB</sub> = -50V, I <sub>E</sub> = 0
Collector-Emitter Cut Off Current	I <sub>CEO</sub>	—	—	-1	uA	V <sub>CE</sub> = -50V, I <sub>B</sub> = 0
Collector-Base Breakdown Voltage	V <sub>(BR)CBO</sub>	-50	—	—	V	I <sub>C</sub> = -10uA, I <sub>E</sub> = 0
Collector-Emitter Breakdown Voltage	V <sub>(BR)CEO</sub>	-50	—	—	V	I <sub>C</sub> = -2mA, I <sub>B</sub> = 0
Input Off Voltage	V <sub>I(OFF)</sub>	-0.3	-0.55	—	V	V <sub>CE</sub> = -5V, I <sub>C</sub> = -100uA
Output Current	I <sub>O(OFF)</sub>	—	—	-1	uA	V <sub>CC</sub> = -50V, V <sub>I</sub> = 0V
<b>ON CHARACTERISTICS (Note 5)</b>						
Collector-Emitter Saturation Voltage	V <sub>CE(SAT)</sub>	—	—	-0.15	V	I <sub>C</sub> = -10mA, I <sub>B</sub> = -0.3mA
		—	—	-0.3	V	I <sub>C</sub> = -200mA, I <sub>B</sub> = -20mA
		—	—	-0.5	V	I <sub>C</sub> = -400mA, I <sub>B</sub> = -40mA
		—	—	-0.6	V	I <sub>C</sub> = -500mA, I <sub>B</sub> = -50mA
DC Current Gain	h <sub>FE</sub>	55	220	—	—	V <sub>CE</sub> = -5V, I <sub>C</sub> = -50mA
		55	225	—	—	V <sub>CE</sub> = -5V, I <sub>C</sub> = -400mA
Input On Voltage	V <sub>I(ON)</sub>	-3	-1.5	—	V	V <sub>O</sub> = -0.3V, I <sub>C</sub> = -20mA
Output Voltage (Equivalent to V <sub>CE(SAT)</sub> )	V <sub>O(ON)</sub>	—	-0.1	-0.3	V	I <sub>O</sub> /I <sub>I</sub> = -50mA / -2.5mA
Input Current	I <sub>I</sub>	—	-18	-45	mA	V <sub>I</sub> = -5V
Base-Emitter Turn-on Voltage	V <sub>BE(ON)</sub>	—	-1.2	-1.6	V	V <sub>CE</sub> = -5V, I <sub>C</sub> = -400mA
Base-Emitter Saturation Voltage	V <sub>BE(SAT)</sub>	—	-1.9	-2.5	V	I <sub>C</sub> = -50mA, I <sub>B</sub> = -5mA
Input Resistor (Base), +/- 30%	R2	0.154	0.22	0.286	KΩ	—
Pull-up Resistor (Base to V <sub>CC</sub> supply), +/- 30%	R1	7	10	13	KΩ	—
Resistor Ratio (Input Resistor/Pullup resistor)	R1/R2	36	45	55	—	—
<b>SMALL SIGNAL CHARACTERISTICS</b>						
Gain Bandwidth Product	f <sub>T</sub>	—	200	—	MHz	V <sub>CE</sub> = -10V, I <sub>E</sub> = -5mA, f = 100MHz

Notes: 5. Short duration pulse test used to minimize self-heating effect.

**Electrical Characteristics:**  
**ESD Protected N-Channel MOSFET (Q2)** @ $T_A = 25^\circ\text{C}$  unless otherwise specified

Characteristic	Symbol	Min	Typ	Max	Unit	Test Condition
<b>OFF CHARACTERISTICS (Note 5)</b>						
Drain-Source Breakdown Voltage	$V_{(BR)DSS}$	60	—	—	V	$V_{GS} = 0V, I_D = 10\mu A$
Zero Gate Voltage Drain Current	$I_{DSS}$	—	—	1	$\mu A$	$V_{GS} = 0V, V_{DS} = 60V$
Gate-Body Leakage Current, Forward	$I_{GSSF}$	—	—	10	$\mu A$	$V_{GS} = 20V, V_{DS} = 0V$
Gate-Body Leakage Current, Reverse	$I_{GSSR}$	—	—	-10	$\mu A$	$V_{GS} = -20V, V_{DS} = 0V$
<b>ON CHARACTERISTICS (Note 5)</b>						
Gate Source Threshold Voltage	$V_{GS(th)}$	1	1.6	2.5	V	$V_{DS} = V_{GS}, I_D = 0.25mA$
Static Drain-Source On-State Voltage	$V_{DS(on)}$	—	0.09	1.9	V	$V_{GS} = 5V, I_D = 50mA$
		—	0.6	3.75		$V_{GS} = 10V, I_D = 500mA$
On-State Drain Current	$I_{D(on)}$	500	—	—	mA	$V_{GS} = 10V,$ $V_{DS} \geq 2 * V_{DS(ON)}$
Static Drain-Source On Resistance	$R_{DS(on)}$	—	1.6	3	$\Omega$	$V_{GS} = 5V, I_D = 50mA$
		—	1.2	2		$V_{GS} = 10V, I_D = 500mA$
Forward Transconductance	$g_{FS}$	80	260	—	mS	$V_{DS} \geq 2 * V_{DS(ON)}, I_D = 200 mA$
<b>DYNAMIC CHARACTERISTICS</b>						
Input Capacitance	$C_{iss}$	—	—	50	pF	$V_{DS} = -25V, V_{GS} = 0V, f = 1MHz$
Output Capacitance	$C_{oss}$	—	—	25	pF	
Reverse Transfer Capacitance	$C_{rss}$	—	—	5	pF	
<b>SWITCHING CHARACTERISTICS (Note 5)</b>						
Turn-On Delay Time	$t_{d(on)}$	—	—	20	ns	$V_{DD} = 30V, V_{GS} = 10V,$ $I_D = 200mA,$ $R_G = 25 \text{ Ohm}, R_L = 150 \text{ Ohm}$
Turn-Off Delay Time	$t_{d(off)}$	—	—	40	ns	
<b>SOURCE-DRAIN (BODY) DIODE CHARACTERISTICS AND MAXIMUM RATINGS</b>						
Drain-Source Diode Forward On-Voltage	$V_{SD}$	—	0.88	1.5	V	$V_{GS} = 0V, I_S = 300 mA^*$
Maximum Continuous Drain-Source Diode Forward Current (Reverse Drain Current)	$I_S$	—	—	300	mA	
Maximum Pulsed Drain-Source Diode Forward Current	$I_{SM}$	—	—	800	mA	

Notes: 5. Short duration pulse test used to minimize self-heating effect.

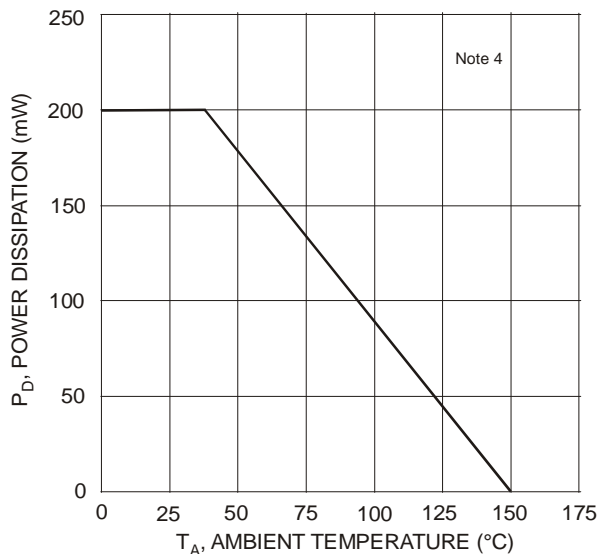

Fig. 3 Max Power Dissipation vs. Ambient Temperature

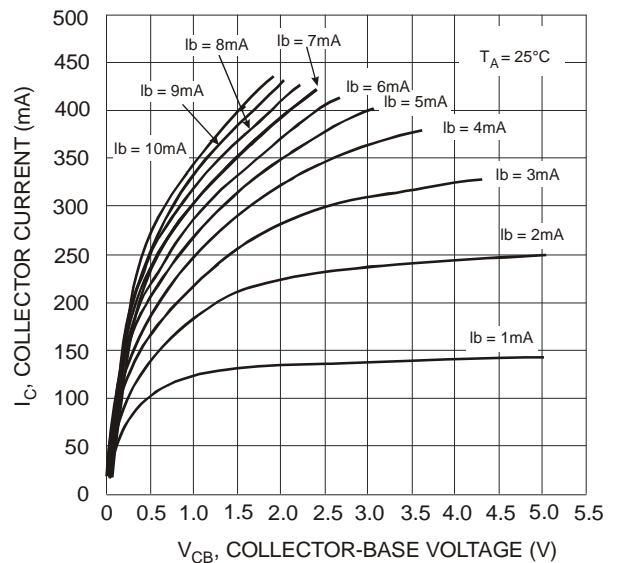

Fig. 4 Output Current vs. Voltage Drop (Pass Element PNP)

**Pre-Biased PNP Transistor Characteristics**

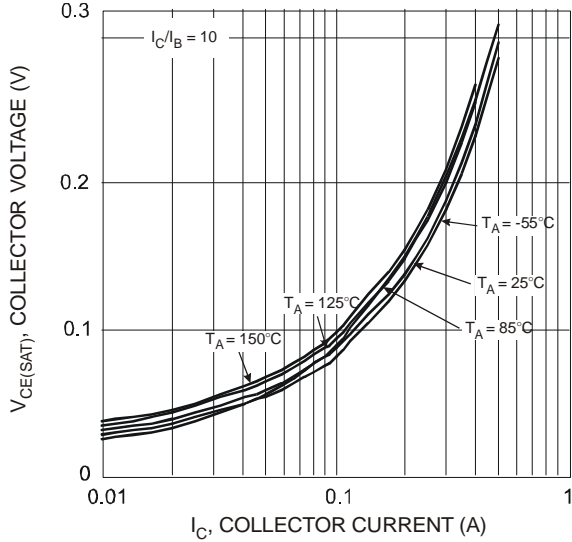

Fig. 5  $V_{CE(SAT)}$  vs.  $I_C$  @  $I_C/I_B = 10$

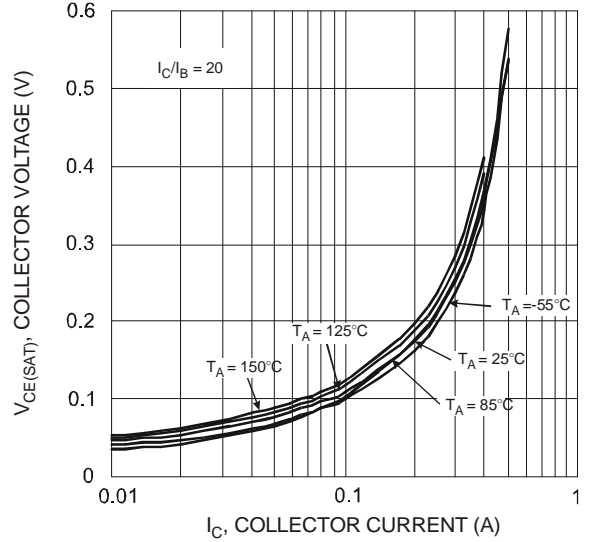

Fig. 6  $V_{CE(SAT)}$  vs.  $I_C$  @  $I_C/I_B = 20$

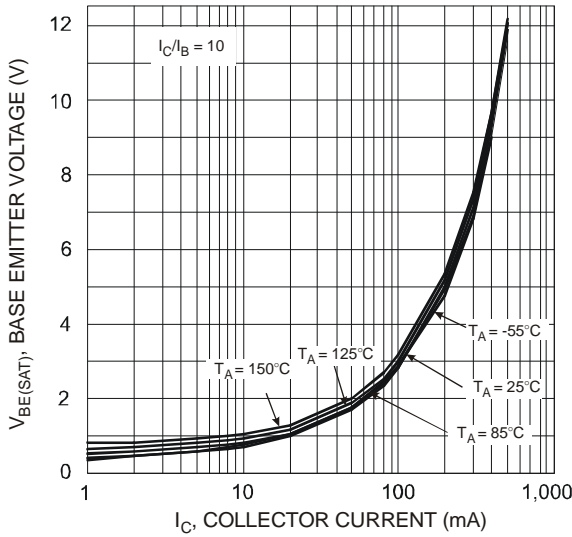

Fig. 7  $V_{BE(SAT)}$  vs.  $I_C$  @  $I_C/I_B = 10$

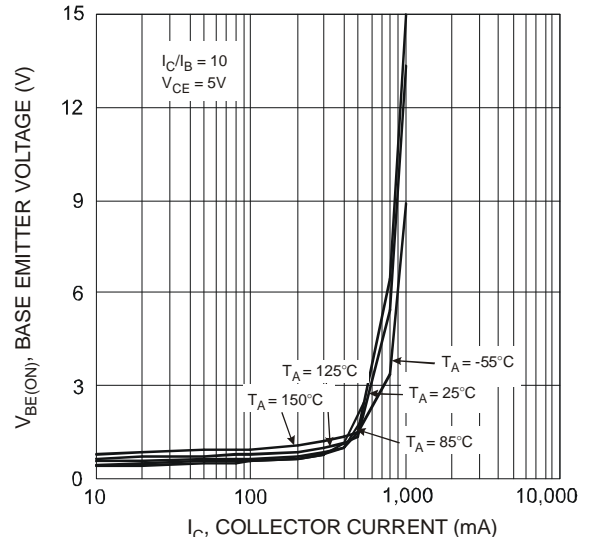

Fig. 8  $V_{BE(ON)}$  vs.  $I_C$  @  $V_{CE} = 5\text{V}$

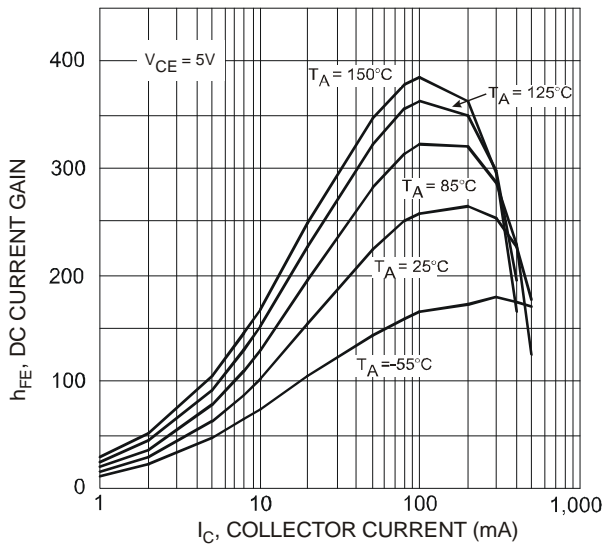

Fig. 9  $h_{FE}$  vs.  $I_C$  @  $V_{CE} = 5\text{V}$

**Typical N-Channel MOSFET (ESD Protected) Characteristics**

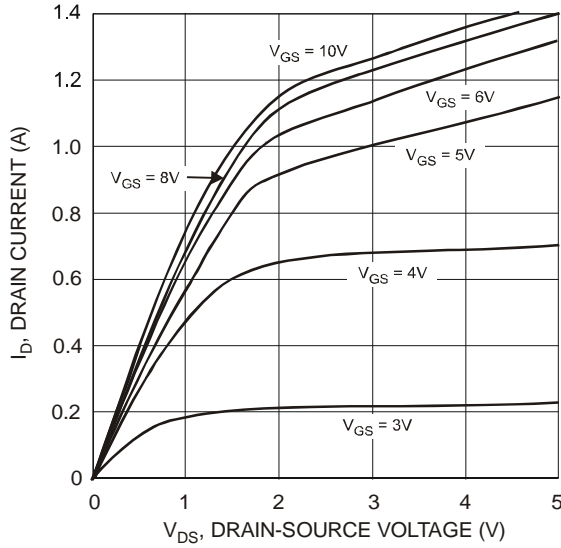

Fig. 10 Output Characteristics

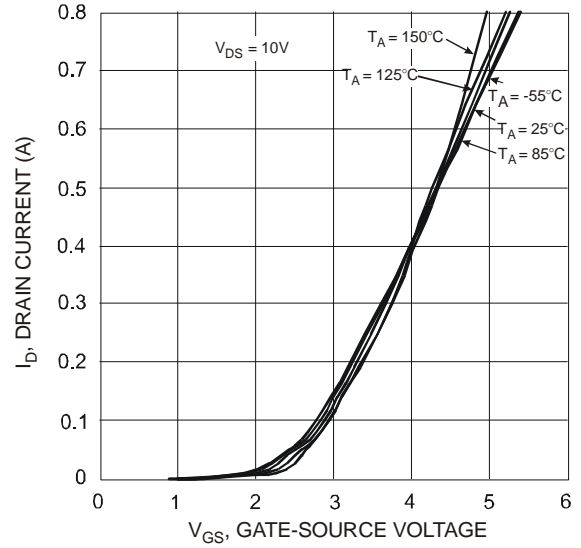

Fig. 11 Transfer Characteristics

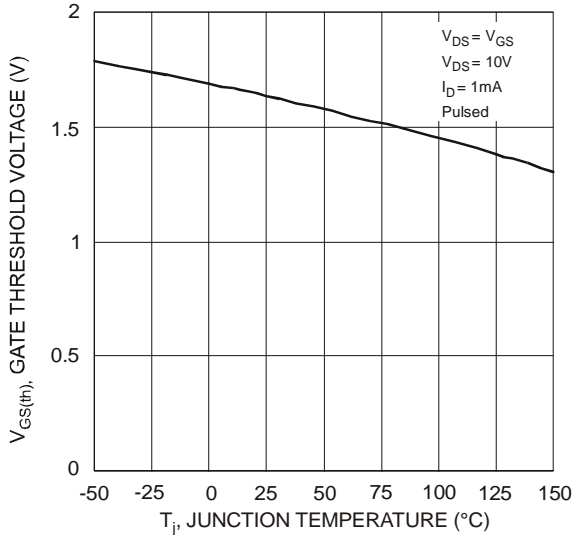

Fig. 12 Gate Threshold Voltage vs. Junction Temperature

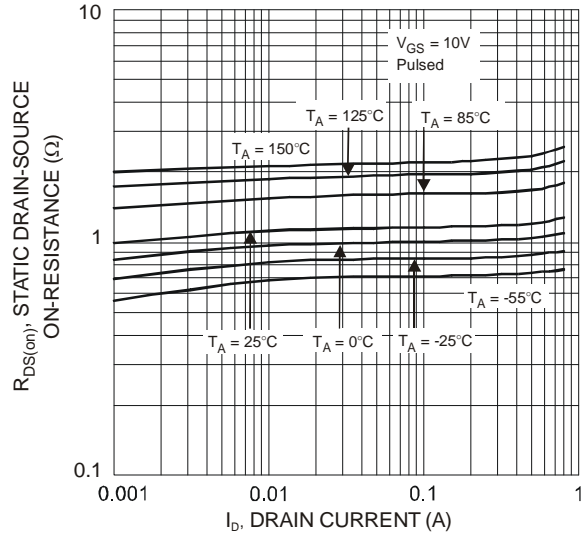

Fig. 13 Static Drain-Source On-Resistance vs. Drain Current

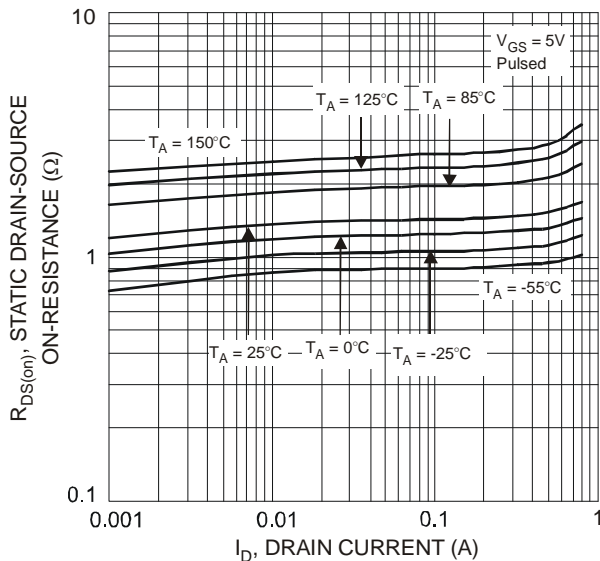

Fig. 14 Static Drain-Source On-Resistance vs. Drain Current

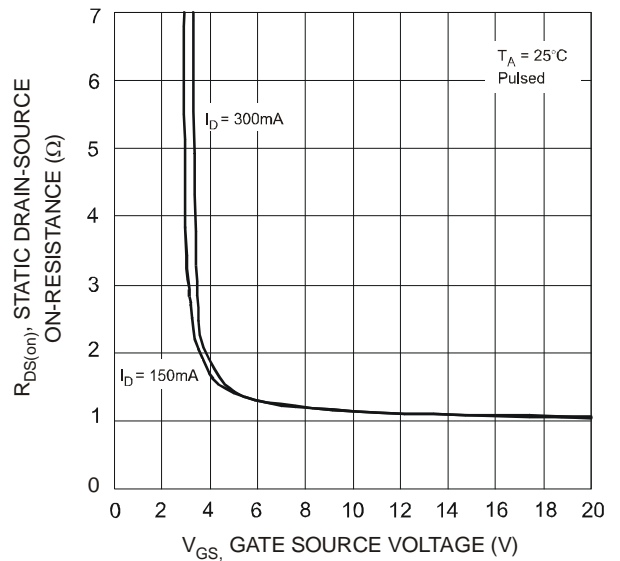

Fig. 15 Static Drain-Source On-Resistance vs. Gate-Source Voltage

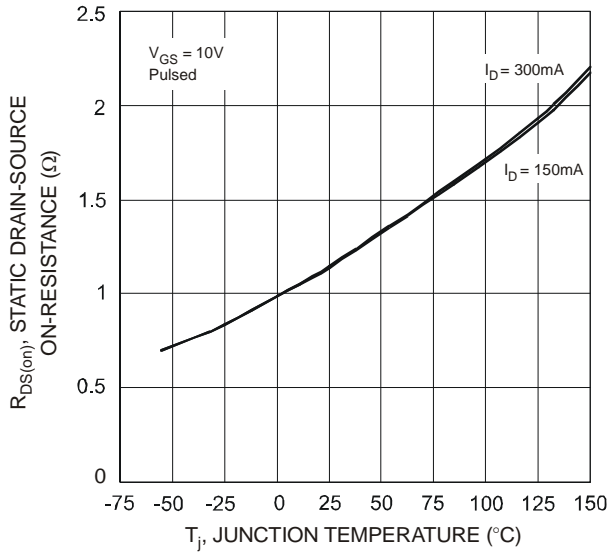

Fig. 16 Static Drain-Source On-State Resistance vs. Junction Temperature

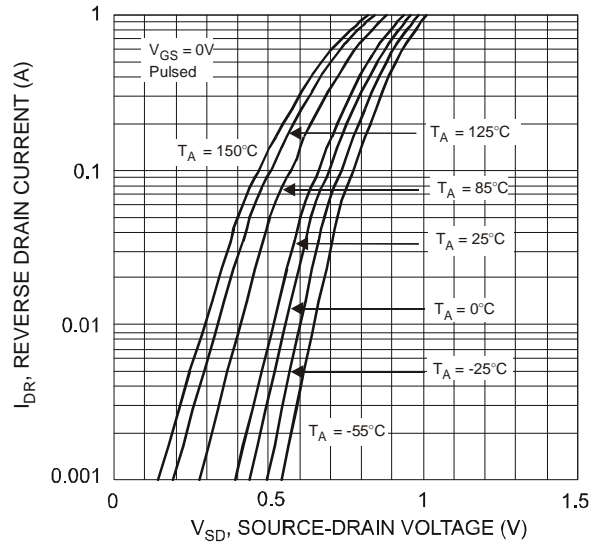

Fig. 17 Reverse Drain Current vs. Source-Drain Voltage

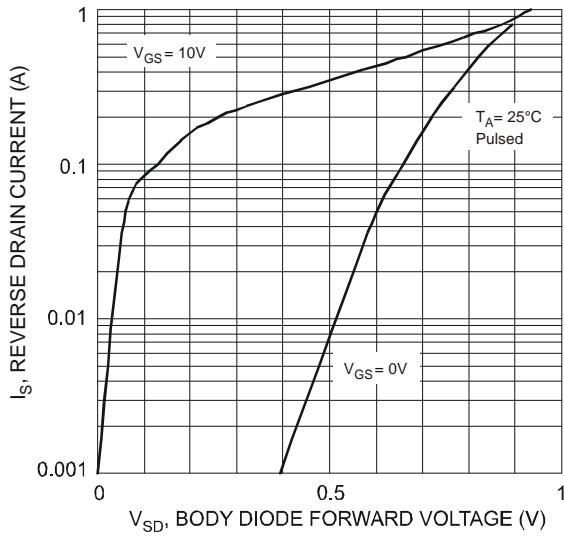

Fig. 18 Reverse Drain Current vs. Source-Drain Voltage

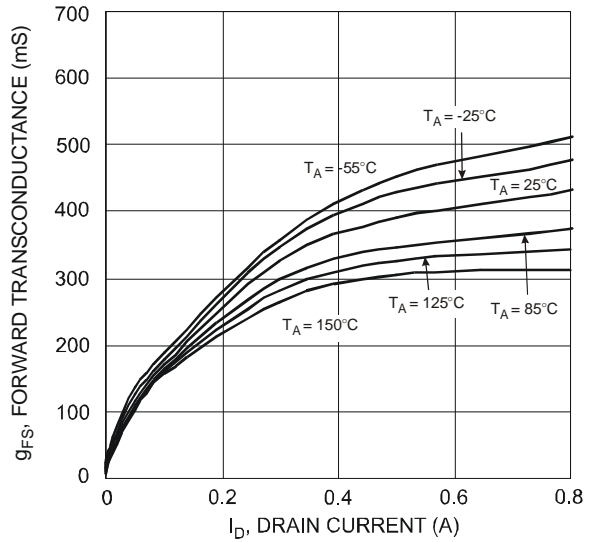

Fig. 19 Forward Transconductance vs. Drain Current ( $V_{DS} > I_D * R_{DS(ON)}$ )

## Application Details

PNP Transistor and ESD Protected N-MOSFET integrated as one in LMN400E01 can be used as a discrete entity for general application or as an integrated circuit to function as a Load Switch. When it is used as the latter as shown in Fig. 20, various input voltage sources can be used as long as it does not exceed the maximum ratings of the device. These devices are designed to deliver continuous output load current up to a maximum of 400 mA. The MOSFET Switch draws no current, hence loading of control circuitry is prevented. Care must be taken for higher levels of dissipation while designing for higher load conditions. These devices provide high power and also consume less space. The product mainly helps in optimizing power usage, thereby conserving battery life in a controlled load system like portable battery powered applications. (Please see Fig. 21 for one example of a typical application circuit used in conjunction with a voltage regulator as a part of power management system).

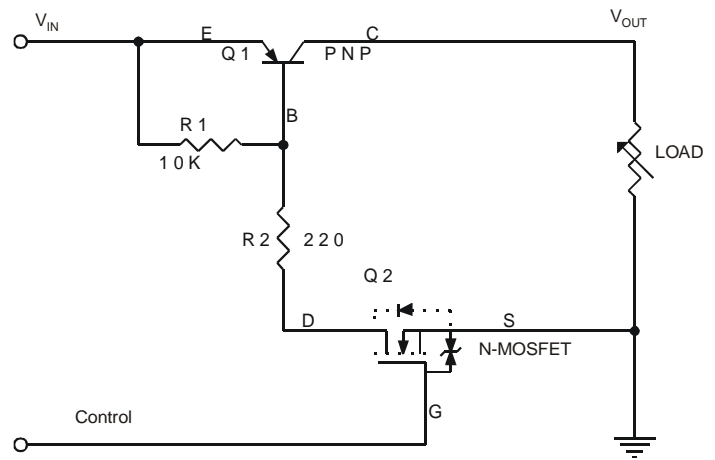

Fig. 20 Circuit Diagram

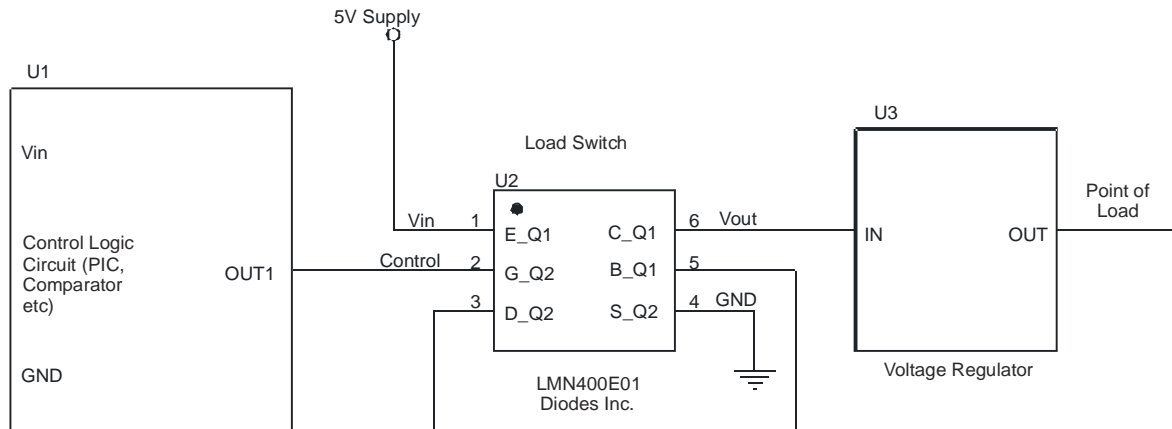
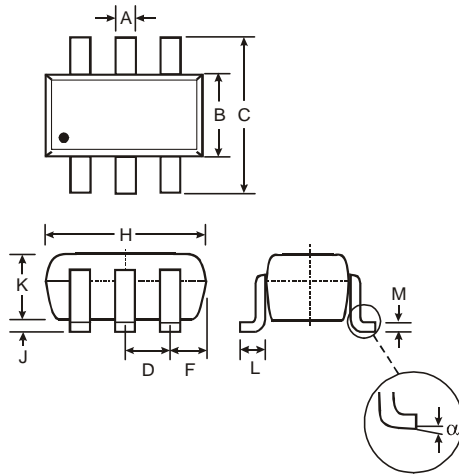

Fig. 21 Typical Application Circuit

**Package Outline Dimensions**



SOT-363		
Dim	Min	Max
A	0.10	0.30
B	1.15	1.35
C	2.00	2.20
D	0.65 Nominal	
F	0.30	0.40
H	1.80	2.20
J	-	0.10
K	0.90	1.00
L	0.25	0.40
M	0.10	0.25
α	0°	8°
All Dimensions in mm		

**Suggested Pad Layout**

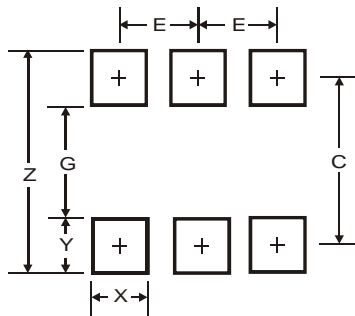

Dimensions	Value (mm)
Z	2.5
G	1.3
X	0.42
Y	0.6
C	1.9
E	0.65

**IMPORTANT NOTICE**

DIODES INCORPORATED MAKES NO WARRANTY OF ANY KIND, EXPRESS OR IMPLIED, WITH REGARDS TO THIS DOCUMENT, INCLUDING, BUT NOT LIMITED TO, THE IMPLIED WARRANTIES OF MERCHANTABILITY AND FITNESS FOR A PARTICULAR PURPOSE (AND THEIR EQUIVALENTS UNDER THE LAWS OF ANY JURISDICTION).

Diodes Incorporated and its subsidiaries reserve the right to make modifications, enhancements, improvements, corrections or other changes without further notice to this document and any product described herein. Diodes Incorporated does not assume any liability arising out of the application or use of this document or any product described herein; neither does Diodes Incorporated convey any license under its patent or trademark rights, nor the rights of others. Any Customer or user of this document or products described herein in such applications shall assume all risks of such use and will agree to hold Diodes Incorporated and all the companies whose products are represented on Diodes Incorporated website, harmless against all damages.

Diodes Incorporated does not warrant or accept any liability whatsoever in respect of any products purchased through unauthorized sales channel. Should Customers purchase or use Diodes Incorporated products for any unintended or unauthorized application, Customers shall indemnify and hold Diodes Incorporated and its representatives harmless against all claims, damages, expenses, and attorney fees arising out of, directly or indirectly, any claim of personal injury or death associated with such unintended or unauthorized application.

Products described herein may be covered by one or more United States, international or foreign patents pending. Product names and markings noted herein may also be covered by one or more United States, international or foreign trademarks.

**LIFE SUPPORT**

Diodes Incorporated products are specifically not authorized for use as critical components in life support devices or systems without the express written approval of the Chief Executive Officer of Diodes Incorporated. As used herein:

A. Life support devices or systems are devices or systems which:

1. are intended to implant into the body, or
2. support or sustain life and whose failure to perform when properly used in accordance with instructions for use provided in the labeling can be reasonably expected to result in significant injury to the user.

B. A critical component is any component in a life support device or system whose failure to perform can be reasonably expected to cause the failure of the life support device or to affect its safety or effectiveness.

Customers represent that they have all necessary expertise in the safety and regulatory ramifications of their life support devices or systems, and acknowledge and agree that they are solely responsible for all legal, regulatory and safety-related requirements concerning their products and any use of Diodes Incorporated products in such safety-critical, life support devices or systems, notwithstanding any devices- or systems-related information or support that may be provided by Diodes Incorporated. Further, Customers must fully indemnify Diodes Incorporated and its representatives against any damages arising out of the use of Diodes Incorporated products in such safety-critical, life support devices or systems.

Copyright © 2011, Diodes Incorporated

[www.diodes.com](http://www.diodes.com)

## Looking for pricing, stock, or lifecycle information?

Click below to explore more details on WIN SOURCE:

-  [View LMN400E01-7 on WIN SOURCE](#)
-  [Diodes Incorporated Information](#)

## Optimize Your Supply Chain with WIN SOURCE Solutions

-  Global Sourcing Solution
-  Obsolete Management
-  Cost Control Management
-  Shortage Management
-  Alternative Solution
-  Excess Inventory Management