



**THE DATASHEET OF  
LMH6703MFX**



## LMH6703 1.2 GHz, Low Distortion Op Amp with Shutdown

### 1 Features

- -3-dB bandwidth ( $V_{OUT} = 0.5 V_{PP}$ ,  $A_V = 2$ ) 1.2 GHz
- 2<sup>nd</sup>/3<sup>rd</sup> Harmonics (20 MHz, SOT-23) -69/-90 dBc
- Low Noise: 2.3 nV/ $\sqrt{\text{Hz}}$
- Fast Slew Rate: 4500 V/ $\mu\text{s}$
- Supply Current: 11 mA
- Output Current: 90 mA
- Low Differential Gain and Phase 0.01%/0.02°

### 2 Applications

- RGB Video Driver
- High Resolution Projectors
- Flash A/D Driver
- D/A Transimpedance Buffer
- Wide Dynamic Range IF Amp
- Radar/Communication Receivers
- DDS Post-Amps
- Line Driver

### 3 Description

The LMH™6703 is a very wideband, DC coupled monolithic operational amplifier designed specifically for ultra high resolution video systems as well as wide dynamic range systems requiring exceptional signal fidelity. Benefitting from current feedback architecture, the LMH6703 offers a practical gain range of  $\pm 1$  to  $\pm 10$  while providing stable operation without external compensation, even at unity gain. At a gain of 2, the LMH6703 supports ultra high resolution video systems with a 750-MHz, 2 V<sub>PP</sub>, -3-dB Bandwidth. With 12-bit distortion levels through 10 MHz ( $R_L = 100 \Omega$ ), and a 2.3-nV/ $\sqrt{\text{Hz}}$  input referred noise, the LMH6703 is the ideal driver or buffer for high speed flash A/D and D/A converters. Wide dynamic range systems such as radar and communication receivers requiring a wideband amplifier offering exceptional signal purity will find the LMH6703 low input referred noise and low harmonic distortion an attractive solution.

#### Device Information<sup>(1)</sup>

PART NUMBER	PACKAGE	BODY SIZE (NOM)
LMH6703	SOIC (8)	4.90 mm x 3.91 mm
	SOT-23 (6)	2.90 mm x 1.60 mm

(1) For all available packages, see the orderable addendum at the end of the data sheet.

#### Harmonic Distortion vs Frequency

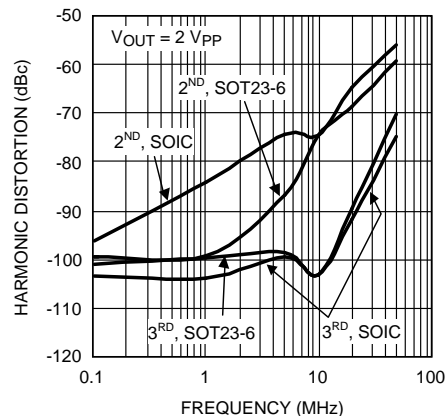

## Table of Contents

<b>1 Features</b> .....	<b>1</b>	8.3 Device Functional Modes.....	<b>12</b>
<b>2 Applications</b> .....	<b>1</b>	<b>9 Application and Implementation</b> .....	<b>15</b>
<b>3 Description</b> .....	<b>1</b>	9.1 Typical Application .....	<b>15</b>
<b>4 Revision History</b> .....	<b>2</b>	<b>10 Power Supply Recommendations</b> .....	<b>17</b>
<b>5 Pin Configuration and Functions</b> .....	<b>3</b>	<b>11 Layout</b> .....	<b>17</b>
<b>6 Specifications</b> .....	<b>4</b>	11.1 Layout Guidelines .....	<b>17</b>
6.1 Absolute Maximum Ratings .....	<b>4</b>	11.2 Layout Example .....	<b>18</b>
6.2 ESD Ratings .....	<b>4</b>	<b>12 Device and Documentation Support</b> .....	<b>19</b>
6.3 Recommended Operating Conditions.....	<b>4</b>	12.1 Documentation Support .....	<b>19</b>
6.4 Thermal Information .....	<b>4</b>	12.2 Community Resources.....	<b>19</b>
6.5 Electrical Characteristics .....	<b>5</b>	12.3 Trademarks .....	<b>19</b>
<b>7 Typical Characteristics</b> .....	<b>7</b>	12.4 Electrostatic Discharge Caution.....	<b>19</b>
<b>8 Detailed Description</b> .....	<b>12</b>	12.5 Glossary .....	<b>19</b>
8.1 Overview .....	<b>12</b>	<b>13 Mechanical, Packaging, and Orderable</b>	<b>19</b>
8.2 Feature Description.....	<b>12</b>	<b>Information</b> .....	<b>19</b>

## 4 Revision History

NOTE: Page numbers for previous revisions may differ from page numbers in the current version.

### Changes from Revision D (March 2013) to Revision E

Page

- Added *Pin Functions* table, *ESD Ratings* table, *Thermal Information* table, *Detailed Description* section, *Application and Implementation* section, *Power Supply Recommendations* section, *Layout* section, *Device and Documentation Support* section, and *Mechanical, Packaging, and Orderable Information* section..... **1**
- Updated maximum value of Input Bias Current (non-inverting) from  $\pm 20$  to  $-20$  in *Electrical Characteristics* ..... **5**
- Updated boldface maximum value (temperature extreme) of Input Bias Current (non-inverting) from  $\pm 23$  to  $-23$  in *Electrical Characteristics* ..... **5**

### Changes from Revision C (March 2013) to Revision D

Page

- Changed layout of National Data Sheet to TI format ..... **14**

## 5 Pin Configuration and Functions

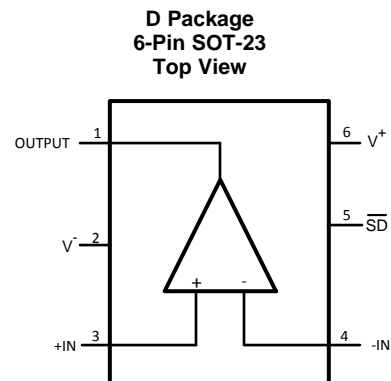
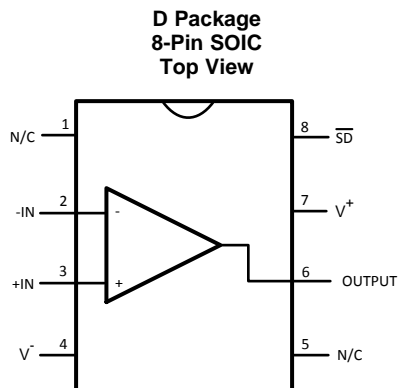

### Pin Functions

NAME	PIN NO.		I/O	DESCRIPTION
	D	DBV		
- IN	2	4	I	Inverting input voltage
+ IN	3	3	I	Non-inverting input voltage
N/C	1, 5	—	—	No connection
OUT	6	1	O	Output
V -	4	2	I	Negative supply
V +	7	6	I	Positive supply
$\overline{\text{SD}}$	8	5	I	Shutdown (active low)

## 6 Specifications

### 6.1 Absolute Maximum Ratings

over operating free-air temperature range (unless otherwise noted)<sup>(1)</sup>

		MIN	MAX	UNIT
$V_S$			±6.75	V
$I_{OUT}$		See <sup>(2)</sup>		
	Common mode input voltage	$V^-$	$V^+$	V
	Maximum junction temperature		150	°C
	Storage temperature	-65	150	°C
	Soldering Information	Infrared or convection (20 sec.)	235	°C
		Wave soldering (10 sec.)	260	

- (1) Stresses beyond those listed under *Absolute Maximum Ratings* may cause permanent damage to the device. These are stress ratings only, which do not imply functional operation of the device at these or any other conditions beyond those indicated under *Recommended Operating Conditions*. Exposure to absolute-maximum-rated conditions for extended periods may affect device reliability.
- (2) The maximum output current ( $I_{OUT}$ ) is determined by device power dissipation limitations.

### 6.2 ESD Ratings

		VALUE	UNIT
$V_{(ESD)}$	Electrostatic discharge	Human-body model (HBM), per ANSI/ESDA/JEDEC JS-001 <sup>(1)</sup>	±2000
		Machine model (MM), per JEDEC specification JESD22-C101, all pins <sup>(2)</sup>	±200
			V

- (1) Human body model: 1.5 k $\Omega$  in series with 100 pF. JEDEC document JEP155 states that 2000-V HBM allows safe manufacturing with a standard ESD control process. Manufacturing with less than 2000-V HBM is possible with the necessary precautions. Pins listed as ±2000 V may actually have higher performance.
- (2) Machine model: 0  $\Omega$  in series with 200 pF. JEDEC document JEP157 states that 200-V MM allows safe manufacturing with a standard ESD control process. Manufacturing with less than 200-V MM is possible with the necessary precautions. Pins listed as ±200 V may actually have higher performance.

### 6.3 Recommended Operating Conditions

over operating free-air temperature range (unless otherwise noted)<sup>(1)</sup>

		MIN	NOM	MAX	UNIT
	Operating temperature	-40		85	°C
	Supply voltage	±4		±6	V

- (1) *Absolute Maximum Ratings* indicate limits beyond which damage to the device may occur. *Recommended Operating Conditions* indicate conditions for which the device is intended to be functional, but specific performance is not ensured. For ensured specifications, see *Electrical Characteristics*.

### 6.4 Thermal Information

THERMAL METRIC <sup>(1)</sup>		LMH6703		UNIT
		DBV (SOT-23)	D (SOIC)	
		6 PINS	8 PINS	
$R_{\theta JA}$	Junction-to-ambient thermal resistance	182	133	°C/W
$R_{\theta JC(top)}$	Junction-to-case (top) thermal resistance	139	79	°C/W
$R_{\theta JB}$	Junction-to-board thermal resistance	40	73	°C/W
$\Psi_{JT}$	Junction-to-top characterization parameter	28	28	°C/W
$\Psi_{JB}$	Junction-to-board characterization parameter	40	73	°C/W

- (1) For more information about traditional and new thermal metrics, see the *Semiconductor and IC Package Thermal Metrics* application report ([SPRA953](#)).

## 6.5 Electrical Characteristics

at  $T_J = 25^\circ\text{C}$ ,  $A_V = 2$ ,  $V_S = \pm 5\text{ V}$ ,  $R_L = 100\ \Omega$ ,  $R_F = 560\ \Omega$ ,  $\overline{\text{SD}} = \text{Floating}$  (unless otherwise noted)<sup>(1)</sup>

**Boldface** limits apply at the temperature extremes.

PARAMETER		CONDITIONS	MIN <sup>(2)</sup>	TYP <sup>(3)</sup>	MAX <sup>(2)</sup>	UNIT
<b>FREQUENCY DOMAIN PERFORMANCE</b>						
SSBW	-3-dB bandwidth	$V_{OUT} = 0.5 V_{PP}$ , $A_V = +1$		1800		MHz
		$V_{OUT} = 0.5 V_{PP}$ , $A_V = +2$		1200		
LSBW		$V_{OUT} = 2 V_{PP}$		750		
		$V_{OUT} = 4 V_{PP}$		500		
GF	0.1-dB gain flatness	$V_{OUT} = 0.5 V_{PP}$		150		MHz
		$V_{OUT} = 2 V_{PP}$		150		
DG	Differential gain	$R_L = 150\ \Omega$ , 4.43 MHz		0.01%		
DP	Differential phase	$R_L = 150\ \Omega$ , 4.43 MHz		0.02		deg
<b>TIME DOMAIN RESPONSE</b>						
$t_r$	Rise time	2-V step, 10% to 90%		0.5		ns
		6-V step, 10% to 90%		1.05		ns
$t_f$	Fall time	2-V step, 10% to 90%		0.5		ns
		6-V step, 10% to 90%		1.05		ns
SR	Slew rate	4-V step, 10% to 90% <sup>(4)</sup>		4200		V/ $\mu\text{s}$
		6-V step, 10% to 90% <sup>(4)</sup>		4500		
$t_s$	Settling time	2-V step, $V_{OUT}$ within 0.1%		10		ns
<b>DISTORTION AND NOISE RESPONSE</b>						
HD2	2 <sup>nd</sup> harmonic distortion	2 $V_{PP}$ , 5 MHz, SOT-23-6		-87		dBc
		2 $V_{PP}$ , 20 MHz, SOT-23-6		-69		
		2 $V_{PP}$ , 50 MHz, SOT-23-6		-60		
HD3	3 <sup>rd</sup> harmonic distortion	2 $V_{PP}$ , 5 MHz, SOT-23-6		-100		dBc
		2 $V_{PP}$ , 20 MHz, SOT-23-6		-90		
		2 $V_{PP}$ , 50 MHz, SOT-23-6		-70		
IMD	3 <sup>rd</sup> order intermodulation products	50 MHz, $P_O = 5\text{ dBm/ tone}$		-80		dBc
$e_n$	Input referred voltage noise	>1 MHz		2.3		nV/ $\sqrt{\text{Hz}}$
$i_n$	Input referred noise current	Inverting Pin >1 MHz		18.5		pA/ $\sqrt{\text{Hz}}$
	Input referred noise current	Non-Inverting Pin >1 MHz		3		pA/ $\sqrt{\text{Hz}}$
<b>u</b>						
$V_{OS}$	Input offset voltage			$\pm 1.5$	$\pm 7$ <b><math>\pm 9</math></b>	mV
$TCV_{OS}$	Input offset voltage average drift	<sup>(5)</sup>		22		$\mu\text{V}/^\circ\text{C}$
$I_B$	Input bias current	Non-Inverting <sup>(6)</sup>		-7	-20 <b>-23</b>	$\mu\text{A}$
		Inverting <sup>(6)</sup>		-2	$\pm 35$ <b><math>\pm 44</math></b>	
$TCI_B$	Input bias current average drift	Non-Inverting <sup>(5)</sup>		+30		nA/ $^\circ\text{C}$
		Inverting <sup>(5)</sup>		-70		

- Electrical Characteristics values apply only for factory testing conditions at the temperature indicated. Factory testing conditions result in very limited self-heating of the device such that  $T_J = T_A$ . Parametric performance is indicated in the electrical tables under conditions of internal self-heating where  $T_J > T_A$ .
- Limits are 100% production tested at 25°C. Limits over the operating temperature range are specified through correlation using Statistical Quality Control (SQC) methods.
- Typical numbers are the most likely parametric norm.
- Slew rate is the average of the rising and falling edges.
- Drift determined by dividing the change in parameter at temperature extremes by the total temperature change.
- Negative input current implies current flowing out of the device.

**Electrical Characteristics (continued)**

 at  $T_J = 25^\circ\text{C}$ ,  $A_V = 2$ ,  $V_S = \pm 5\text{ V}$ ,  $R_L = 100\ \Omega$ ,  $R_F = 560\ \Omega$ ,  $\overline{SD} = \text{Floating}$  (unless otherwise noted)<sup>(1)</sup>
**Boldface** limits apply at the temperature extremes.

PARAMETER		CONDITIONS	MIN <sup>(2)</sup>	TYP <sup>(3)</sup>	MAX <sup>(2)</sup>	UNIT
$V_O$	Output voltage range	$R_L = \infty$	<b><math>\pm 3.3</math></b>	$\pm 3.45$		V
		$R_L = 100\ \Omega$	$\pm 3.2$ <b><math>\pm 3.14</math></b>	$\pm 3.4$		
PSRR	Power supply rejection ratio	$V_S = \pm 4.0\text{ V}$ to $\pm 6.0\text{ V}$	48 <b>46</b>	52		dB
CMRR	Common mode rejection ratio	$V_{CM} = -1.0\text{ V}$ to $+1.0\text{ V}$	45 <b>44</b>	47		dB
$I_S$	Supply current (enabled)	$\overline{SD} = 2\text{ V}$ , $R_L = \infty$		11	12.5 <b>15.0</b>	mA
	Supply current (disabled)	$\overline{SD} = 0.8\text{ V}$ , $R_L = \infty$		0.2	0.900 <b>0.935</b>	mA
<b>MISCELLANEOUS PERFORMANCE</b>						
$R_{IN+}$	Non-inverting input resistance			1		M $\Omega$
$R_{IN-}$	Inverting input resistance	Output Impedance of Input Buffer		30		$\Omega$
$C_{IN}$	Non-inverting input capacitance			0.8		pF
$R_O$	Output resistance	Closed Loop		0.05		$\Omega$
CMVR	Input common mode voltage range	CMRR $\geq 40\text{ dB}$	$\pm 1.9$			V
$I_O$	Linear output current	$V_{IN} = 0\text{ V}$ , $V_{OUT} \leq \pm 80\text{ mV}$	$\pm 55$	$\pm 90$		mA
<b>ENABLE/DISABLE PERFORMANCE (DISABLED LOW)</b>						
$T_{ON}$	Enable time			10		ns
$T_{OFF}$	Disable time			10		ns
	Output glitch			50		mV <sub>PP</sub>
$V_{IH}$	Enable voltage	$\overline{SD} \geq V_{IH}$	2.0			V
$V_{IL}$	Disable voltage	$\overline{SD} \leq V_{IL}$			0.8	V
$I_{IH}$	Disable pin bias current, high	$\overline{SD} = V^+^{(6)}$		-7	$\pm 70$	$\mu\text{A}$
$I_{IL}$	Disable pin bias current, low	$\overline{SD} = 0\text{ V}^{(6)}$	-50	-240	-400	$\mu\text{A}$
$I_{OZ}$	Disabled output leakage current	$V_{OUT} = \pm 1.8\text{ V}$		0.07	$\pm 25$ <b><math>\pm 40</math></b>	$\mu\text{A}$

## 7 Typical Characteristics

at  $A_V = 2$ ,  $R_L = 100 \Omega$ ,  $V_S = \pm 5 \text{ V}$ ,  $R_F = 560 \Omega$ ,  $T_A = 25^\circ\text{C}$ , SOT-23-6 (unless otherwise noted)

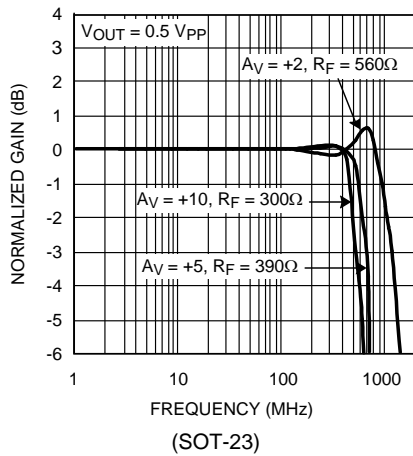

Figure 1. Small Signal Non-Inverting Frequency Response

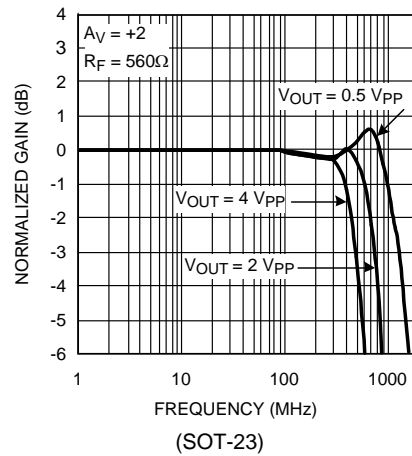

Figure 2. Large Signal Frequency Response

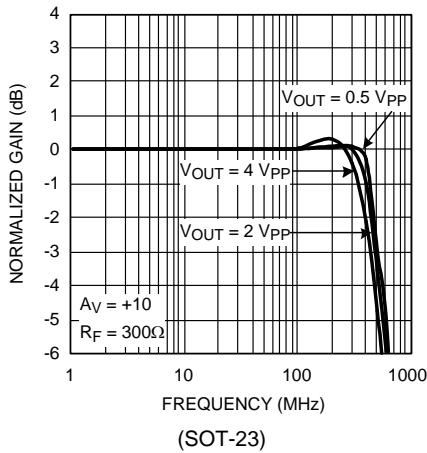

Figure 3. Large Signal Frequency Response

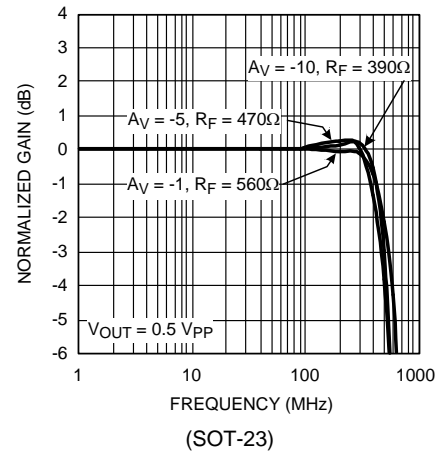

Figure 4. Small Signal Inverting Frequency Response

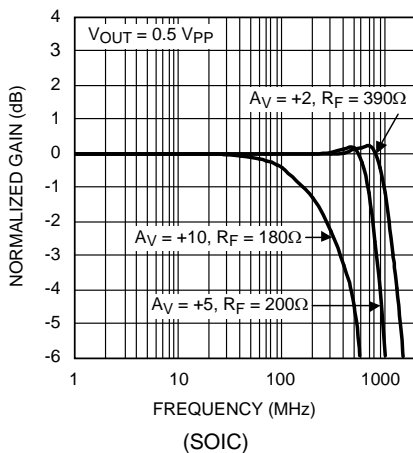

Figure 5. Small Signal Non-Inverting Frequency Response

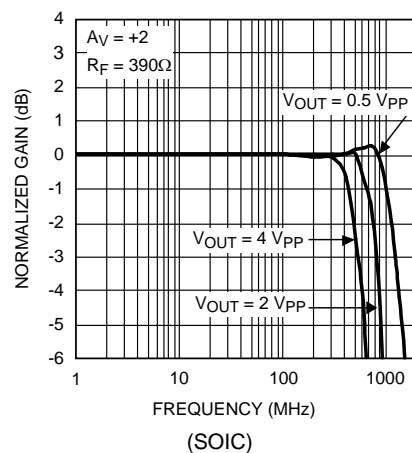

Figure 6. Large Signal Frequency Response

### Typical Characteristics (continued)

at  $A_V = 2$ ,  $R_L = 100 \Omega$ ,  $V_S = \pm 5 \text{ V}$ ,  $R_F = 560 \Omega$ ,  $T_A = 25^\circ\text{C}$ , SOT-23-6 (unless otherwise noted)

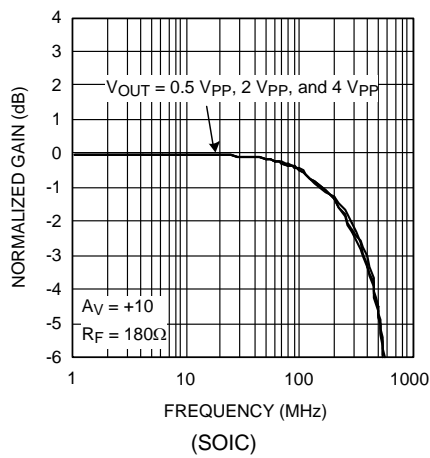

Figure 7. Large Signal Frequency Response

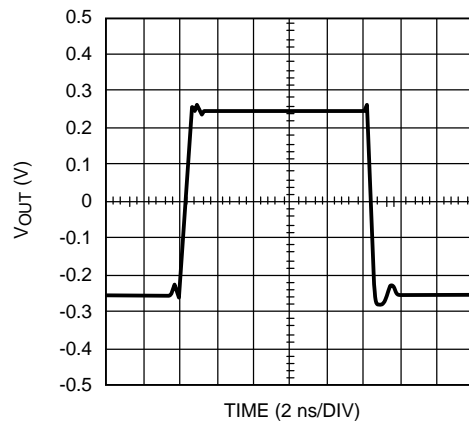

Figure 8. Small Signal Pulse Response

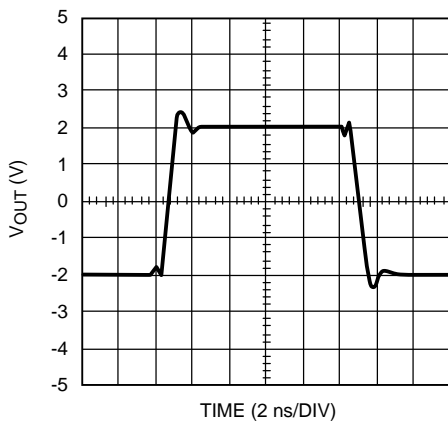

Figure 9. Large Signal Pulse Response

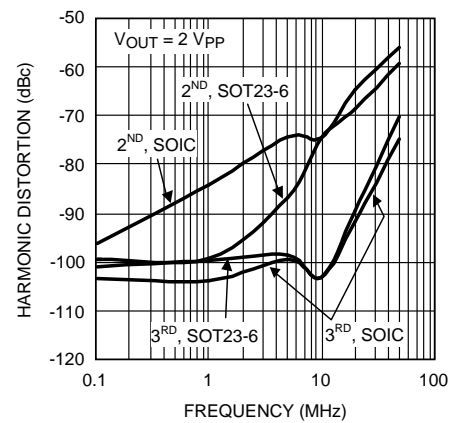

Figure 10. Harmonic Distortion vs Frequency

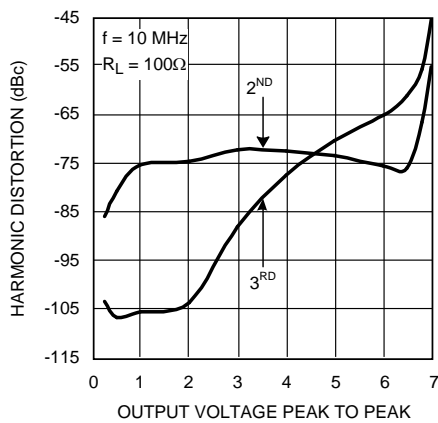

Figure 11. Harmonic Distortion vs Output Voltage

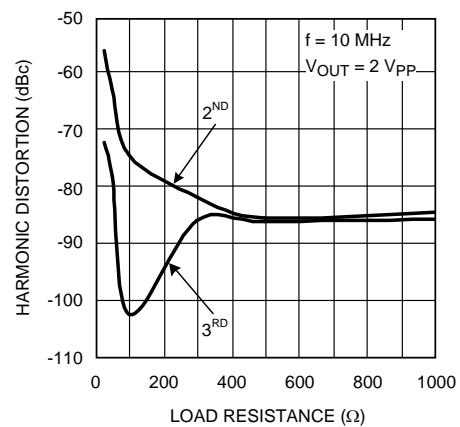
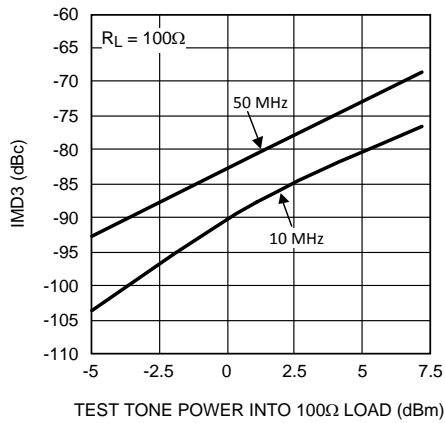

Figure 12. Harmonic Distortion vs. Load

**Typical Characteristics (continued)**

at  $A_V = 2$ ,  $R_L = 100 \Omega$ ,  $V_S = \pm 5 \text{ V}$ ,  $R_F = 560 \Omega$ ,  $T_A = 25^\circ\text{C}$ , SOT-23-6 (unless otherwise noted)



**Figure 13. 2-Tone 3<sup>rd</sup> Order Intermodulation**

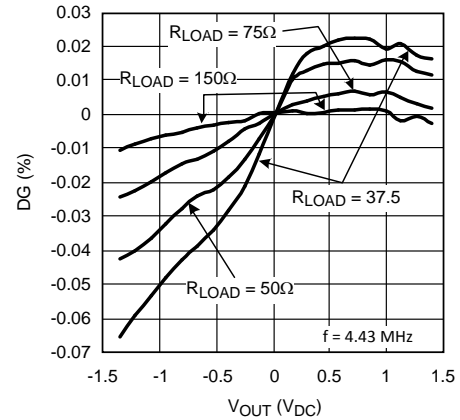

**Figure 14. Differential Gain**

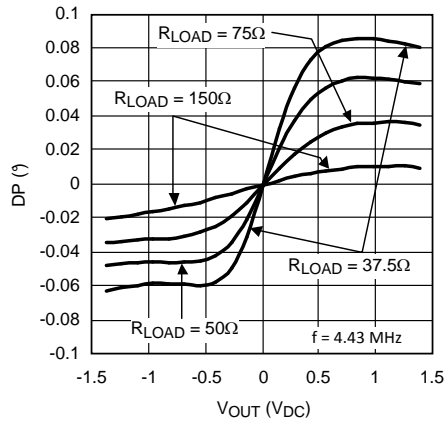

**Figure 15. Differential Phase**

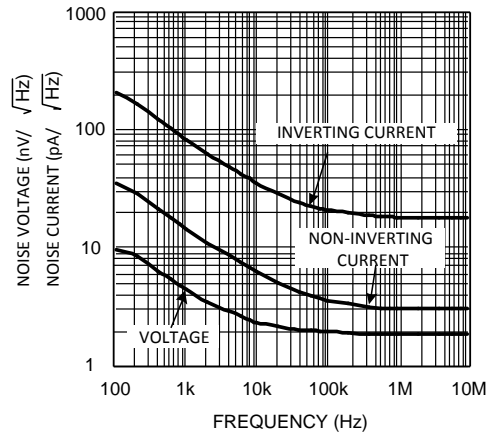

**Figure 16. Noise**

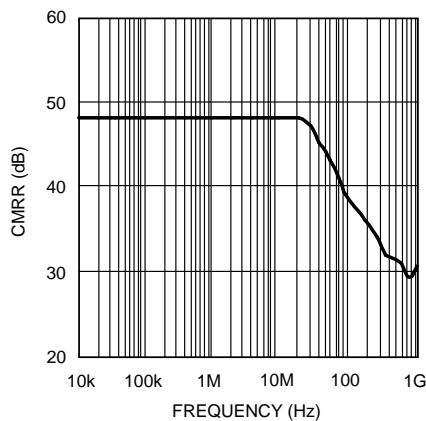

**Figure 17. CMRR vs Frequency**

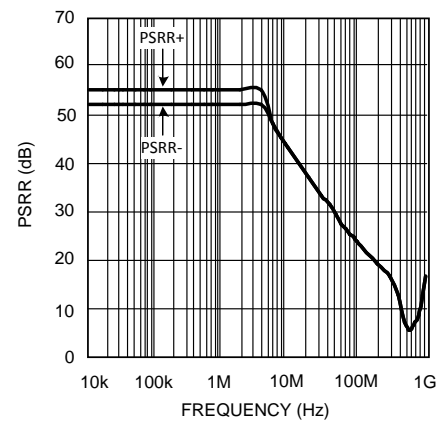

**Figure 18. PSRR vs Frequency**

### Typical Characteristics (continued)

at  $A_V = 2$ ,  $R_L = 100 \Omega$ ,  $V_S = \pm 5 \text{ V}$ ,  $R_F = 560 \Omega$ ,  $T_A = 25^\circ\text{C}$ , SOT-23-6 (unless otherwise noted)

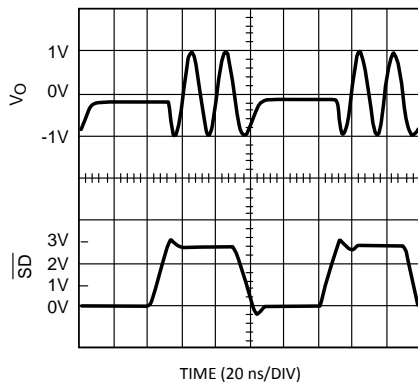

Figure 19. Disable Timing

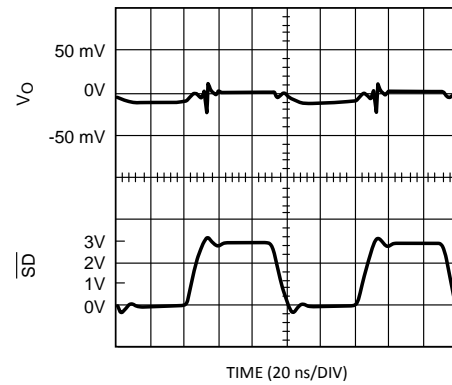
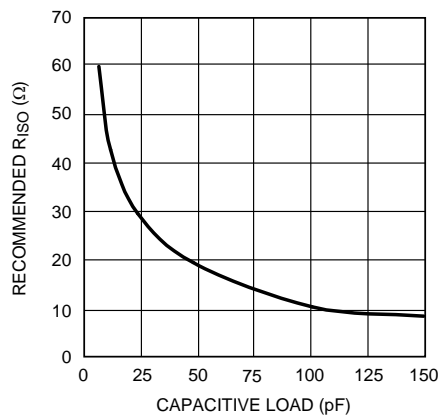

Figure 20. Disable Output Glitch



(See [Application and Implementation](#))

Figure 21.  $R_{ISO}$  VS  $C_{LOAD}$

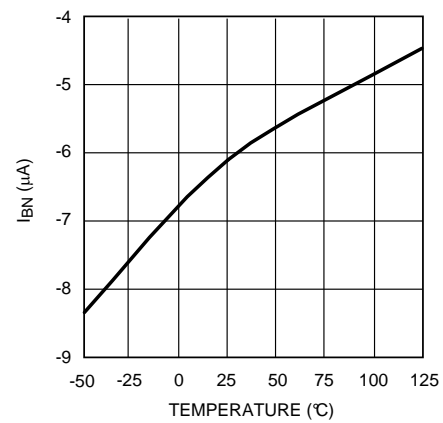

Figure 22. Non-Inverting Input Bias vs Temperature

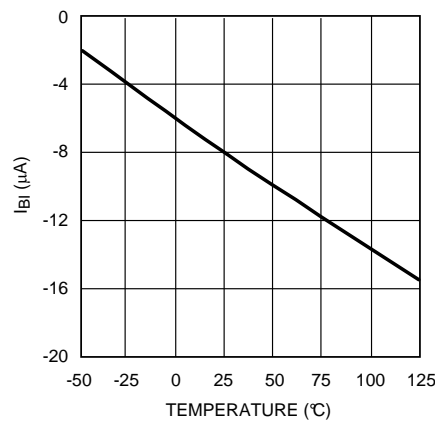

Figure 23. Inverting Input Bias vs Temperature

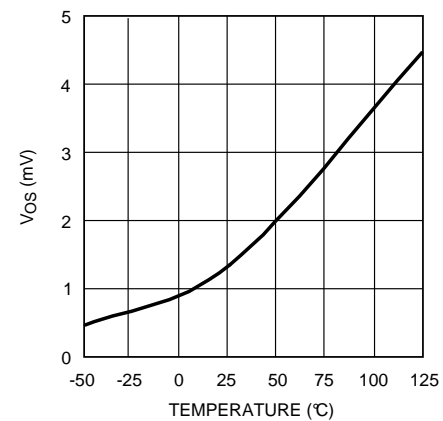
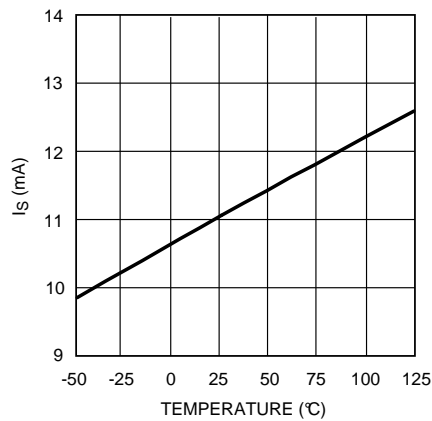

Figure 24. Input Offset vs Temperature

**Typical Characteristics (continued)**

at  $A_V = 2$ ,  $R_L = 100 \Omega$ ,  $V_S = \pm 5 \text{ V}$ ,  $R_F = 560 \Omega$ ,  $T_A = 25^\circ\text{C}$ , SOT-23-6 (unless otherwise noted)



**Figure 25. Supply Current vs Temperature**

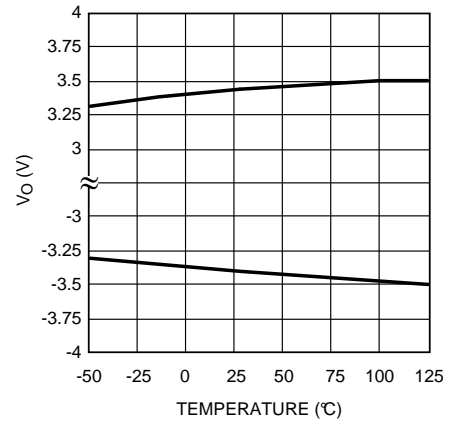

**Figure 26. Voltage Swing vs Temperature**

## 8 Detailed Description

### 8.1 Overview

The LMH6703 has been optimized for exceptionally low harmonic distortion while driving very demanding resistive or capacitive loads. Generally, when used as the input amplifier to very high speed flash ADCs, the distortions introduced by the converter will dominate over the low LMH6703 distortions shown in [Typical Characteristics](#).

### 8.2 Feature Description

The LMH6703 is a high speed current feedback amplifier, optimized for excellent bandwidth, gain flatness, and low distortion. The loop gain for a current feedback op amp, and hence the frequency response, is predominantly set by the feedback resistor value. The LMH6703 in the SOT-23-6 package is optimized for use with a 560- $\Omega$  feedback resistor. The LMH6703 in the SOIC package is optimized for use with a 390- $\Omega$  feedback resistor. Using lower values can lead to excessive ringing in the pulse response while a higher value will limit the bandwidth. Application Note OA-13 ([SNOA366](#)) discusses this in detail along with the occasions where a different  $R_F$  might be advantageous.

### 8.3 Device Functional Modes

#### 8.3.1 Feedback Resistor Selection

One of the key benefits of a current feedback operational amplifier is the ability to maintain optimum frequency response independent of gain by using appropriate values for the feedback resistor ( $R_F$ ). The Electrical Characteristics and Typical Characteristics plots specify an  $R_F$  of 560  $\Omega$  (390  $\Omega$  for the SOIC package), a gain of 2 V/V, and  $\pm 5$ -V power supplies (unless otherwise specified). Generally, lowering  $R_F$  from its recommended value will peak the frequency response and extend the bandwidth while increasing the value of  $R_F$  will cause the frequency response to roll off faster. Reducing the value of  $R_F$  too far below its recommended value will cause overshoot, ringing and, eventually, oscillation.

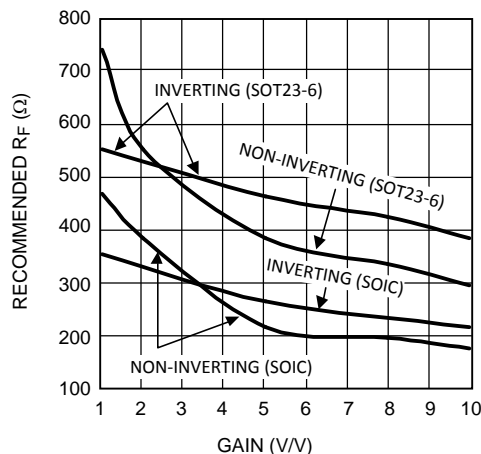

**Figure 27. Recommended  $R_F$  vs. Gain**

Since a current feedback amplifier is dependant on the value of  $R_F$  to provide frequency compensation and since the value of  $R_F$  can be used to optimize the frequency response, different packages use different  $R_F$  values. As shown in [Figure 27](#), the SOT-23-6 and the SOIC package use different values for the feedback resistor,  $R_F$ . Since each application is slightly different, it is worth some experimentation to find the optimal  $R_F$  for a given circuit. In general, a value of  $R_F$  that produces  $\approx 0.1$  dB of peaking is the best compromise between stability and maximum bandwidth. Note that it is not possible to use a current feedback amplifier with the output shorted directly to the inverting input. The buffer configuration of the LMH6703 requires a 560  $\Omega$  (390  $\Omega$  for SOIC package) feedback resistor for stable operation.

## Device Functional Modes (continued)

The LMH6703 was optimized for high speed operation. As shown in [Figure 27](#), the suggested value for  $R_F$  decreases for higher gains. Due to the output impedance of the input buffer, there is a practical limit for how small  $R_F$  can go, based on the lowest practical value of  $R_G$ . This limitation applies to both inverting and non inverting configurations. For the LMH6703 the input resistance of the inverting input is approximately 30Ω and 20Ω is a practical (but not hard and fast) lower limit for  $R_G$ . The LMH6703 begins to operate in a gain bandwidth limited fashion in the region when  $R_G$  is nearly equal to the input buffer impedance. Note that the amplifier will operate with  $R_G$  values well below 20 Ω, however results may be substantially different than predicted from ideal models. In particular the voltage potential between the Inverting and Non-Inverting inputs cannot be expected to remain small.

Inverting gain applications that require impedance matched inputs may limit gain flexibility somewhat (especially if maximum bandwidth is required). The impedance seen by the source is  $R_G \parallel R_T$  ( $R_T$  is optional). The value of  $R_G$  is  $R_F / \text{Gain}$ . Thus for a SOT-23 in a gain of  $-5\text{V/V}$ , an  $R_F$  of 460 Ω is optimum and  $R_G$  is 92 Ω. Without a termination resistor,  $R_T$ , the input impedance would equal  $R_G$ , 92 Ω. Using an  $R_T$  of 109Ω will set the input resistance to match a 50-Ω source. Note that source impedances greater than  $R_G$  cannot be matched in the inverting configuration.

For more information see Application Note OA-13 ([SNOA366](#)) which describes the relationship between  $R_F$  and closed-loop frequency response for current feedback operational amplifiers. The value for the inverting input impedance for the LMH6703 is approximately 30 Ω. The LMH6703 is designed for optimum performance at gains of 1 to 10 V/V and  $-1$  to  $-9$  V/V. Higher gain configurations are still useful, however, the bandwidth will fall as gain is increased, much like a typical voltage feedback amplifier.

The LMH6703 data sheet shows both SOT-23-6 and SOIC data in the Electrical Characteristic section to aid in selecting the right package. The Typical Characteristics section shows SOT-23-6 package plots only.

### 8.3.2 DC Accuracy and Noise

Example below shows the output offset computation equation for the non-inverting configuration (see [Figure 29](#)) using the typical bias current and offset specifications for  $A_V = 2$ :

$$\text{Output Offset} : V_O = (I_{BN} \times R_{IN} \pm V_{OS}) (1 + R_F/R_G) \pm I_{BI} \times R_F$$

Where  $R_{IN}$  is the equivalent input impedance on the non-inverting input.

Example computation for  $A_V = 2$ ,  $R_F = 560 \Omega$ ,  $R_{IN} = 25 \Omega$ :

$$V_O = (7 \mu\text{A} \times 25 \Omega \pm 1.5 \text{ mV}) (1 + 560/560) \pm 2 \mu\text{A} \times 560 \approx -3.7 \text{ mV to } 4.5 \text{ mV}$$

A good design, however, should include a worst case calculation using Min/Max numbers in the data sheet tables, in order to ensure "worst case" operation.

Further improvement in the output offset voltage and drift is possible using the composite amplifiers described in Application Note OA-07 ([SNOA365](#)). The two input bias currents are physically unrelated in both magnitude and polarity for the current feedback topology. It is not possible, therefore, to cancel their effects by matching the source impedance for the two inputs (as is commonly done for matched input bias current devices).

The total output noise is computed in a similar fashion to the output offset voltage. Using the input noise voltage and the two input noise currents, the output noise is developed through the same gain equations for each term but combined as the square root of the sum of squared contributing elements. See Application Note OA-12 ([SNOA375](#)) for a full discussion of noise calculations for current feedback amplifiers.

## Device Functional Modes (continued)

### 8.3.3 Enable/Disable

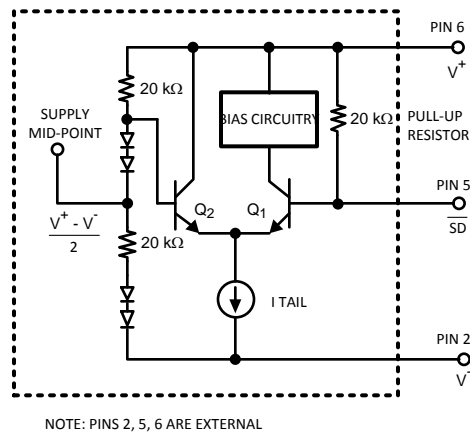

**Figure 28.  $\overline{\text{SD}}$  Pin Simplified Schematic (SOT-23 Pinout Shown)**

For 5-V supplies only, the LMH6703 has a TTL logic compatible disable function. Apply a logic low ( $< 0.8$  V) to the  $\overline{\text{SD}}$  pin and the LMH6703 is disabled. Apply a logic high ( $> 2.0$  V), or let the pin float and the LMH6703 is enabled. Voltage, not current, at the Shutdown pin ( $\overline{\text{SD}}$ ) determines the enable/disable state. Care must be exercised to prevent the shutdown pin voltage from going more than 0.8 V below the midpoint of the supply voltages (0V with split supplies,  $V^+/2$  with single supply biasing). Doing so could cause transistor Q1 to Zener resulting in damage to the disable circuit (See [Figure 28](#)). The core amplifier is unaffected by this, but the shutdown operation could become permanently slower as a result.

Disabled, the LMH6703 inputs and output become high impedances. While disabled the LMH6703 quiescent current is approximately 200  $\mu\text{A}$ . Because of the pull up resistor on the shutdown circuit, the  $I_{\text{CC}}$  and  $I_{\text{EE}}$  currents (positive and negative supply currents respectively) are not balanced in the disabled state. The positive supply current ( $I_{\text{CC}}$ ) is approximately 300  $\mu\text{A}$  while the negative supply current ( $I_{\text{EE}}$ ) is only 200  $\mu\text{A}$ . The remaining  $I_{\text{EE}}$  current of 100  $\mu\text{A}$  flows through the shutdown pin.

The disable function can be used to create analog switches or multiplexers. Implement a single analog switch with one LMH6703 positioned between an input and output. Create an analog multiplexer with several LMH6703s and tie the outputs together.

## 9 Application and Implementation

### NOTE

Information in the following applications sections is not part of the TI component specification, and TI does not warrant its accuracy or completeness. TI's customers are responsible for determining suitability of components for their purposes. Customers should validate and test their design implementation to confirm system functionality.

### 9.1 Typical Application

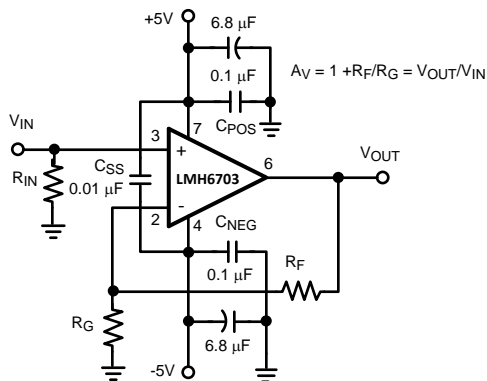

Figure 29. Recommended Non-Inverting Gain Circuit (SOIC Pinout Shown)

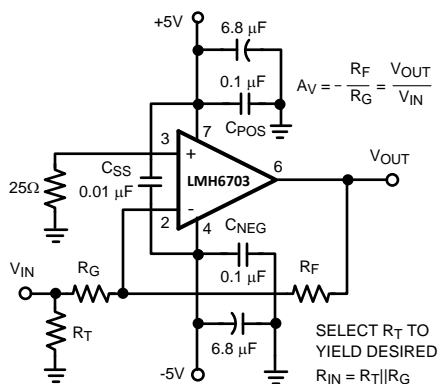

Figure 30. Recommended Inverting Gain Circuit (SOIC Pinout Shown)

#### 9.1.1 Capacitive Load Drive

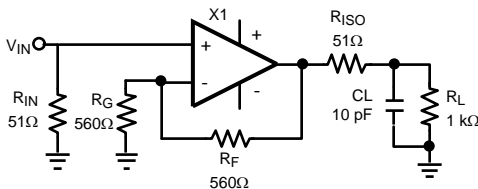
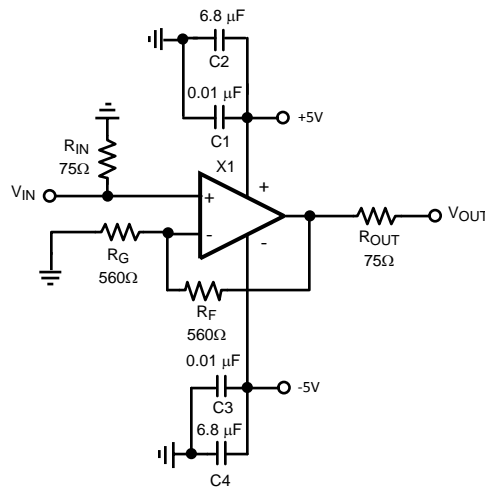

Figure 31. Decoupling Capacitive Loads

## Typical Application (continued)

Capacitive output loading applications will benefit from the use of a series output resistor  $R_{ISO}$ . Figure 31 shows the use of a series output resistor,  $R_{ISO}$ , to stabilize the amplifier output under capacitive loading. Capacitive loads from 5 to 120 pF are the most critical, causing ringing, frequency response peaking and possible oscillation. Figure 21 gives a recommended value for selecting a series output resistor for mitigating capacitive loads. The values suggested in the charts are selected for 0.5 dB or less of peaking in the frequency response. This produces a good compromise between settling time and bandwidth. For applications where maximum frequency response is needed and some peaking is tolerable, the value of  $R_{ISO}$  can be reduced slightly from the recommended values.

### 9.1.2 Video Performance



**Figure 32. Typical Video Application**

The LMH6703 has been designed to provide excellent performance with production quality video signals in a wide variety of formats such as HDTV and High Resolution VGA. NTSC and PAL performance is nearly flawless with DG of 0.01% and DP of 0.02°. Best performance will be obtained with back terminated loads. The back termination reduces reflections from the transmission line and effectively masks transmission line and other parasitic capacitance from the amplifier output stage. Figure 32 shows a typical configuration for driving 75Ω cable. The amplifier is configured for a gain of two compensating for the 6 dB loss due to  $R_{OUT}$ .

## 10 Power Supply Recommendations

The LMH6703 can operate off a single supply or with dual supplies as long as the input CM voltage range (CMIR) has the required headroom to either supply rail. Supplies should be decoupled with low inductance, often ceramic, capacitors to ground less than 0.5 inches from the device pins. The use of ground plane is recommended, and as in most high speed devices, it is advisable to remove ground plane close to device sensitive pins such as the inputs.

## 11 Layout

### 11.1 Layout Guidelines

Whenever questions about layout arise, use the evaluation board (see [Table 1](#)) as a guide. The LMH730216 is the evaluation board for SOT-23-6 samples and the LMH730227 is the evaluation board for SOIC samples.

To reduce parasitic capacitances, ground and power planes should be removed near the input and output pins. Components in the feedback path should be placed as close to the device as possible to minimize parasitic capacitance. For long signal paths controlled impedance lines should be used, along with impedance matching elements at both ends.

Bypass capacitors should be placed as close to the device as possible. Bypass capacitors from each voltage rail to ground are applied in pairs. The larger electrolytic bypass capacitors can be located further from the device, the smaller ceramic bypass capacitors should be placed as close to the device as possible. In [Figure 29](#) and [Figure 30](#),  $C_{SS}$  is optional, but is recommended for best second order harmonic distortion.

Generally, a good high frequency layout will keep power supply and ground traces away from the inverting input and output pins. Parasitic capacitances on these nodes to ground will cause frequency response peaking and possible circuit oscillations. See *Frequent Faux Pas in Applying Wideband Current Feedback Amplifiers*, Application Note OA-15 ([SNOA367](#)). The evaluation board(s) is a good example of high frequency layout techniques as a reference.

General high-speed, signal-path layout suggestions include:

- Continuous ground planes are preferred for signal routing, as shown in [Figure 33](#) and [Figure 34](#), with matched impedance traces for longer runs. However, open up both ground and power planes around the capacitive sensitive input and output device pins.
- Use good, high-frequency decoupling capacitors (0.1  $\mu\text{F}$ ) on the ground plane at the device power pins as shown in [Figure 33](#). Higher value capacitors (2.2  $\mu\text{F}$ ) are required, but may be placed further from the device power pins and shared among devices. For best high-frequency decoupling, consider X2Y supply-decoupling capacitors that offer a much higher self-resonance frequency over standard capacitors.
- When using differential signal routing over any appreciable distance, use microstrip layout techniques with matched impedance traces.
- The input summing junction is very sensitive to parasitic capacitance. Connect any  $R_f$  and  $R_g$  elements into the summing junction with minimal trace length to the device pin side of the resistor, as shown in [Figure 34](#). The other side of these elements can have more trace length if needed to the source or to ground.

**Table 1. Evaluation Boards**

DEVICE	PACKAGE	EVALUATION BOARD PART NUMBER
LMH6703MF	SOT-23-6	LMH730216
LMH6703MA	SOIC	LMH730227

## 11.2 Layout Example

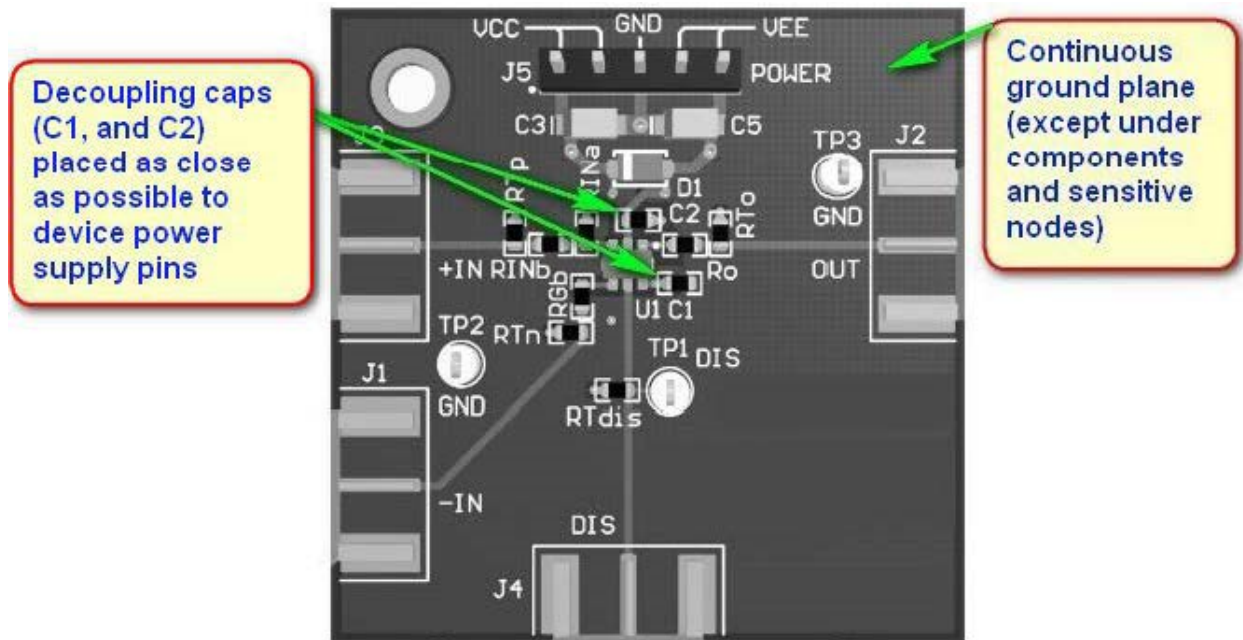

Figure 33. Evaluation Board Layer 1

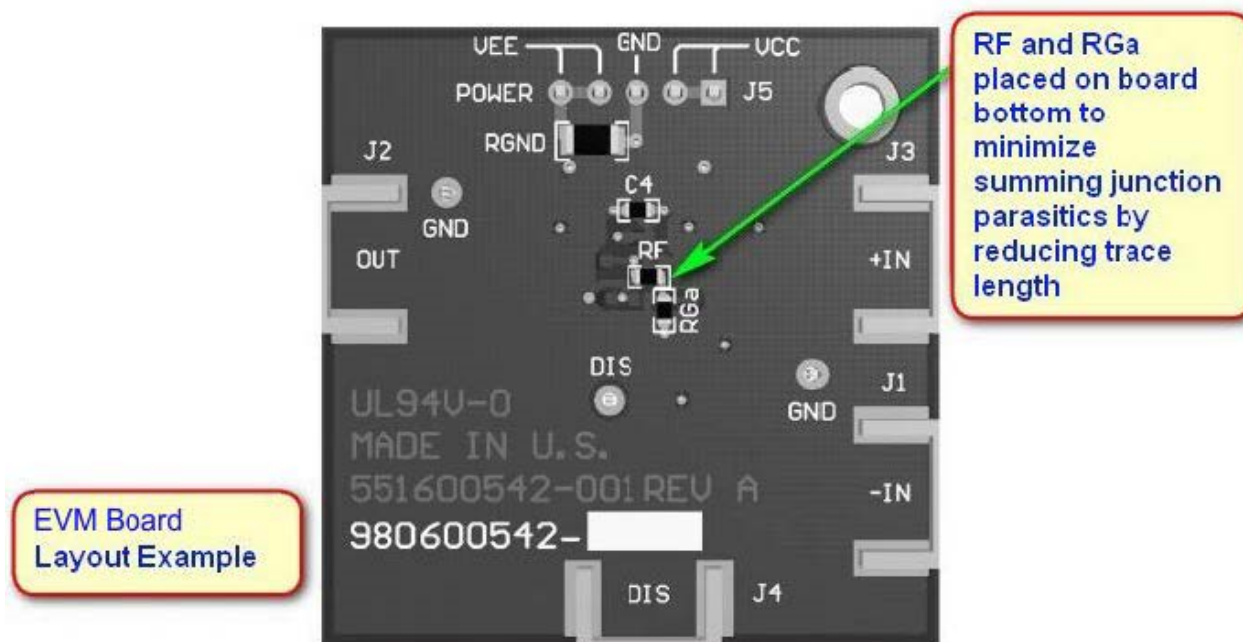

Figure 34. Evaluation Board Layer 2

## 12 Device and Documentation Support

### 12.1 Documentation Support

#### 12.1.1 Related Documentation

For related documentation see the following:

- Absolute Maximum Ratings for Soldering ([SNOA549](#))
- Current Feedback Op Amp Applications Circuit Guide, Application Note OA--07 ([SNOA365](#))
- Frequent Faux Pas in Applying Wideband Current Feedback Amplifiers, Application Note OA-15 ([SNOA367](#))
- Noise Analysis for Comlinear Amplifiers, Application Note OA-12 ([SNOA375](#))
- Semiconductor and IC Package Thermal Metrics ([SPRA953](#))

### 12.2 Community Resources

The following links connect to TI community resources. Linked contents are provided "AS IS" by the respective contributors. They do not constitute TI specifications and do not necessarily reflect TI's views; see TI's [Terms of Use](#).

**TI E2E™ Online Community** *TI's Engineer-to-Engineer (E2E) Community*. Created to foster collaboration among engineers. At [e2e.ti.com](#), you can ask questions, share knowledge, explore ideas and help solve problems with fellow engineers.

**Design Support** *TI's Design Support* Quickly find helpful E2E forums along with design support tools and contact information for technical support.

### 12.3 Trademarks

LMH, E2E are trademarks of Texas Instruments.

All other trademarks are the property of their respective owners.

### 12.4 Electrostatic Discharge Caution



These devices have limited built-in ESD protection. The leads should be shorted together or the device placed in conductive foam during storage or handling to prevent electrostatic damage to the MOS gates.

### 12.5 Glossary

[SLYZ022](#) — *TI Glossary*.

This glossary lists and explains terms, acronyms, and definitions.

## 13 Mechanical, Packaging, and Orderable Information

The following pages include mechanical, packaging, and orderable information. This information is the most current data available for the designated devices. This data is subject to change without notice and revision of this document. For browser-based versions of this data sheet, refer to the left-hand navigation.

**PACKAGING INFORMATION**

Orderable Device	Status (1)	Package Type	Package Drawing	Pins	Package Qty	Eco Plan (2)	Lead/Ball Finish (6)	MSL Peak Temp (3)	Op Temp (°C)	Device Marking (4/5)	Samples
LMH6703MA/NOPB	ACTIVE	SOIC	D	8	95	Green (RoHS & no Sb/Br)	CU SN	Level-1-260C-UNLIM	-40 to 85	LMH6703MA	<a href="#">Samples</a>
LMH6703MAX/NOPB	ACTIVE	SOIC	D	8	2500	Green (RoHS & no Sb/Br)	CU SN	Level-1-260C-UNLIM	-40 to 85	LMH6703MA	<a href="#">Samples</a>
LMH6703MF/NOPB	ACTIVE	SOT-23	DBV	6	1000	Green (RoHS & no Sb/Br)	CU SN	Level-1-260C-UNLIM	-40 to 85	AR1A	<a href="#">Samples</a>
LMH6703MFX/NOPB	ACTIVE	SOT-23	DBV	6	3000	Green (RoHS & no Sb/Br)	CU SN	Level-1-260C-UNLIM	-40 to 85	AR1A	<a href="#">Samples</a>

(1) The marketing status values are defined as follows:

**ACTIVE:** Product device recommended for new designs.

**LIFEBUY:** TI has announced that the device will be discontinued, and a lifetime-buy period is in effect.

**NRND:** Not recommended for new designs. Device is in production to support existing customers, but TI does not recommend using this part in a new design.

**PREVIEW:** Device has been announced but is not in production. Samples may or may not be available.

**OBSELETE:** TI has discontinued the production of the device.

(2) Eco Plan - The planned eco-friendly classification: Pb-Free (RoHS), Pb-Free (RoHS Exempt), or Green (RoHS & no Sb/Br) - please check <http://www.ti.com/productcontent> for the latest availability information and additional product content details.

**TBD:** The Pb-Free/Green conversion plan has not been defined.

**Pb-Free (RoHS):** TI's terms "Lead-Free" or "Pb-Free" mean semiconductor products that are compatible with the current RoHS requirements for all 6 substances, including the requirement that lead not exceed 0.1% by weight in homogeneous materials. Where designed to be soldered at high temperatures, TI Pb-Free products are suitable for use in specified lead-free processes.

**Pb-Free (RoHS Exempt):** This component has a RoHS exemption for either 1) lead-based flip-chip solder bumps used between the die and package, or 2) lead-based die adhesive used between the die and leadframe. The component is otherwise considered Pb-Free (RoHS compatible) as defined above.

**Green (RoHS & no Sb/Br):** TI defines "Green" to mean Pb-Free (RoHS compatible), and free of Bromine (Br) and Antimony (Sb) based flame retardants (Br or Sb do not exceed 0.1% by weight in homogeneous material)

(3) MSL, Peak Temp. - The Moisture Sensitivity Level rating according to the JEDEC industry standard classifications, and peak solder temperature.

(4) There may be additional marking, which relates to the logo, the lot trace code information, or the environmental category on the device.

(5) Multiple Device Markings will be inside parentheses. Only one Device Marking contained in parentheses and separated by a "~" will appear on a device. If a line is indented then it is a continuation of the previous line and the two combined represent the entire Device Marking for that device.

(6) Lead/Ball Finish - Orderable Devices may have multiple material finish options. Finish options are separated by a vertical ruled line. Lead/Ball Finish values may wrap to two lines if the finish value exceeds the maximum column width.

**Important Information and Disclaimer:** The information provided on this page represents TI's knowledge and belief as of the date that it is provided. TI bases its knowledge and belief on information provided by third parties, and makes no representation or warranty as to the accuracy of such information. Efforts are underway to better integrate information from third parties. TI has taken and continues to take reasonable steps to provide representative and accurate information but may not have conducted destructive testing or chemical analysis on incoming materials and chemicals. TI and TI suppliers consider certain information to be proprietary, and thus CAS numbers and other limited information may not be available for release.

In no event shall TI's liability arising out of such information exceed the total purchase price of the TI part(s) at issue in this document sold by TI to Customer on an annual basis.

**TAPE AND REEL INFORMATION**

**QUADRANT ASSIGNMENTS FOR PIN 1 ORIENTATION IN TAPE**

\*All dimensions are nominal

Device	Package Type	Package Drawing	Pins	SPQ	Reel Diameter (mm)	Reel Width W1 (mm)	A0 (mm)	B0 (mm)	K0 (mm)	P1 (mm)	W (mm)	Pin1 Quadrant
LMH6703MAX/NOPB	SOIC	D	8	2500	330.0	12.4	6.5	5.4	2.0	8.0	12.0	Q1
LMH6703MF/NOPB	SOT-23	DBV	6	1000	178.0	8.4	3.2	3.2	1.4	4.0	8.0	Q3
LMH6703MFX/NOPB	SOT-23	DBV	6	3000	178.0	8.4	3.2	3.2	1.4	4.0	8.0	Q3

**TAPE AND REEL BOX DIMENSIONS**

\*All dimensions are nominal

Device	Package Type	Package Drawing	Pins	SPQ	Length (mm)	Width (mm)	Height (mm)
LMH6703MAX/NOPB	SOIC	D	8	2500	367.0	367.0	35.0
LMH6703MF/NOPB	SOT-23	DBV	6	1000	210.0	185.0	35.0
LMH6703MFX/NOPB	SOT-23	DBV	6	3000	210.0	185.0	35.0

# DBV0006A



# PACKAGE OUTLINE

SOT-23 - 1.45 mm max height

SMALL OUTLINE TRANSISTOR

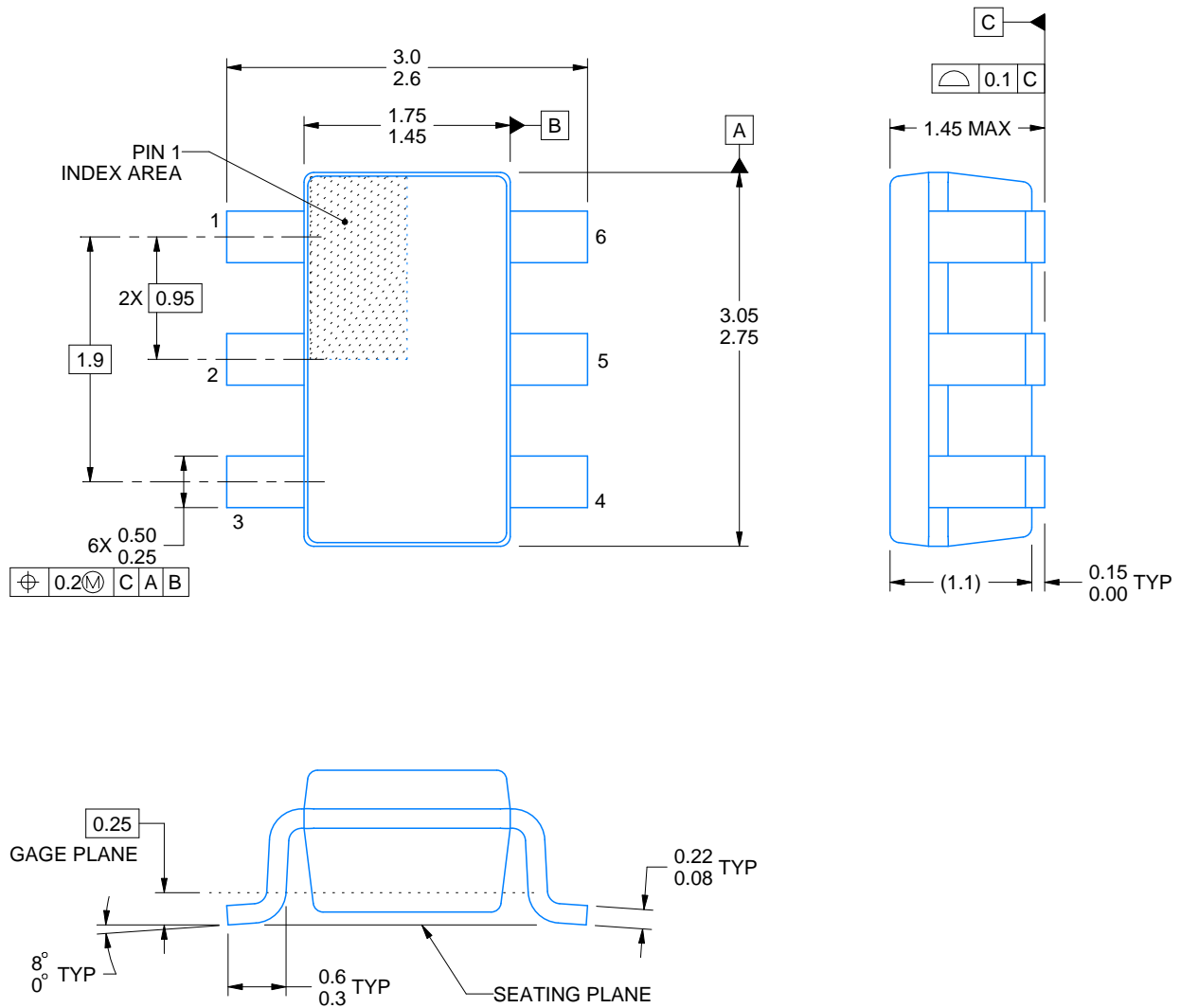

4214840/B 03/2018

## NOTES:

1. All linear dimensions are in millimeters. Any dimensions in parenthesis are for reference only. Dimensioning and tolerancing per ASME Y14.5M.
2. This drawing is subject to change without notice.
3. Body dimensions do not include mold flash or protrusion. Mold flash and protrusion shall not exceed 0.15 per side.
4. Leads 1,2,3 may be wider than leads 4,5,6 for package orientation.
5. Reference JEDEC MO-178.

# EXAMPLE BOARD LAYOUT

DBV0006A

SOT-23 - 1.45 mm max height

SMALL OUTLINE TRANSISTOR



LAND PATTERN EXAMPLE  
EXPOSED METAL SHOWN  
SCALE:15X



SOLDER MASK DETAILS

4214840/B 03/2018

NOTES: (continued)

- 6. Publication IPC-7351 may have alternate designs.
- 7. Solder mask tolerances between and around signal pads can vary based on board fabrication site.

# EXAMPLE STENCIL DESIGN

DBV0006A

SOT-23 - 1.45 mm max height

SMALL OUTLINE TRANSISTOR



SOLDER PASTE EXAMPLE  
BASED ON 0.125 mm THICK STENCIL  
SCALE:15X

4214840/B 03/2018

NOTES: (continued)

8. Laser cutting apertures with trapezoidal walls and rounded corners may offer better paste release. IPC-7525 may have alternate design recommendations.
9. Board assembly site may have different recommendations for stencil design.



D0008A

# PACKAGE OUTLINE

SOIC - 1.75 mm max height

SMALL OUTLINE INTEGRATED CIRCUIT



4214825/C 02/2019

## NOTES:

- Linear dimensions are in inches [millimeters]. Dimensions in parenthesis are for reference only. Controlling dimensions are in inches. Dimensioning and tolerancing per ASME Y14.5M.
- This drawing is subject to change without notice.
- This dimension does not include mold flash, protrusions, or gate burrs. Mold flash, protrusions, or gate burrs shall not exceed  $.006$  [0.15] per side.
- This dimension does not include interlead flash.
- Reference JEDEC registration MS-012, variation AA.

# EXAMPLE BOARD LAYOUT

D0008A

SOIC - 1.75 mm max height

SMALL OUTLINE INTEGRATED CIRCUIT



LAND PATTERN EXAMPLE  
EXPOSED METAL SHOWN  
SCALE:8X



SOLDER MASK DETAILS

4214825/C 02/2019

NOTES: (continued)

- 6. Publication IPC-7351 may have alternate designs.
- 7. Solder mask tolerances between and around signal pads can vary based on board fabrication site.

# EXAMPLE STENCIL DESIGN

D0008A

SOIC - 1.75 mm max height

SMALL OUTLINE INTEGRATED CIRCUIT



SOLDER PASTE EXAMPLE  
BASED ON .005 INCH [0.125 MM] THICK STENCIL  
SCALE:8X

4214825/C 02/2019

NOTES: (continued)

8. Laser cutting apertures with trapezoidal walls and rounded corners may offer better paste release. IPC-7525 may have alternate design recommendations.
9. Board assembly site may have different recommendations for stencil design.

## IMPORTANT NOTICE AND DISCLAIMER

TI PROVIDES TECHNICAL AND RELIABILITY DATA (INCLUDING DATASHEETS), DESIGN RESOURCES (INCLUDING REFERENCE DESIGNS), APPLICATION OR OTHER DESIGN ADVICE, WEB TOOLS, SAFETY INFORMATION, AND OTHER RESOURCES "AS IS" AND WITH ALL FAULTS, AND DISCLAIMS ALL WARRANTIES, EXPRESS AND IMPLIED, INCLUDING WITHOUT LIMITATION ANY IMPLIED WARRANTIES OF MERCHANTABILITY, FITNESS FOR A PARTICULAR PURPOSE OR NON-INFRINGEMENT OF THIRD PARTY INTELLECTUAL PROPERTY RIGHTS.

These resources are intended for skilled developers designing with TI products. You are solely responsible for (1) selecting the appropriate TI products for your application, (2) designing, validating and testing your application, and (3) ensuring your application meets applicable standards, and any other safety, security, or other requirements. These resources are subject to change without notice. TI grants you permission to use these resources only for development of an application that uses the TI products described in the resource. Other reproduction and display of these resources is prohibited. No license is granted to any other TI intellectual property right or to any third party intellectual property right. TI disclaims responsibility for, and you will fully indemnify TI and its representatives against, any claims, damages, costs, losses, and liabilities arising out of your use of these resources.

TI's products are provided subject to TI's Terms of Sale ([www.ti.com/legal/termsofsale.html](http://www.ti.com/legal/termsofsale.html)) or other applicable terms available either on [ti.com](http://ti.com) or provided in conjunction with such TI products. TI's provision of these resources does not expand or otherwise alter TI's applicable warranties or warranty disclaimers for TI products.

Mailing Address: Texas Instruments, Post Office Box 655303, Dallas, Texas 75265  
Copyright © 2019, Texas Instruments Incorporated

## Looking for pricing, stock, or lifecycle information?

Click below to explore more details on WIN SOURCE:

 [View LMH6703MFX](#) on WIN SOURCE

 [Texas Instruments](#) Information

## Optimize Your Supply Chain with WIN SOURCE Solutions

-  Global Sourcing Solution
-  Obsolete Management
-  Cost Control Management
-  Shortage Management
-  Alternative Solution
-  Excess Inventory Management