



**THE DATASHEET OF
LMH2180SDE/NOPB**



LMH2180 75 MHz Dual Clock Buffer

Check for Samples: [LMH2180](#)

FEATURES

- (Typical Values are: $V_{\text{SUPPLY}} = 2.7\text{V}$ and $C_L = 10\text{ pF}$, unless Otherwise Specified.)
- Small Signal Bandwidth 78 MHz
- Supply Voltage Range 2.4V to 5V
- Phase Noise ($V_{\text{IN}} = 1\text{ V}_{\text{PP}}$, $f_C = 38.4\text{ MHz}$, $\Delta f = 1\text{ kHz}$) -123 dBc/Hz
- Slew Rate 106 V/ μs
- Total Supply Current 2.3 mA
- Shutdown Current 30 μA
- Rail-to-Rail Input and Output
- Individual Buffer Enable Pins
- Rapid T_{on} Technology
- Crosstalk Rejection Circuitry
- Packages:
 - 8-Pin WSON, Solder Bump and no Pullback
 - 8-Bump DSBGA
- Temperature Range -40°C to 85°C

APPLICATIONS

- 3G Mobile Applications
- WLAN–WiMAX Modules
- TD_SCDMA Multi-Mode MP3 and Camera
- GSM Modules
- Oscillator Modules

DESCRIPTION

The LMH2180 is a high speed dual clock buffer designed for portable communications and applications requiring multiple accurate multi-clock systems. The LMH2180 integrates two 75 MHz low noise buffers with independent shutdown pins into a small package. The LMH2180 ensures superb system operation between the baseband and the oscillator signal path by eliminating crosstalk between the multiple clock signals.

Unique technology and design provides the LMH2180 with the ability to accurately drive both large capacitive and resistive loads. Low supply current combined with shutdown pins for each channel means the LMH2180 is ideal for battery powered applications. This part does not use an internal ground reference, thus providing additional system flexibility.

The flexible buffers provide system designers the capacity to manage complex clock signals in the latest wireless applications. Each buffer delivers 106 V/ μs internal slew rate with independent shutdown and duty cycle precision. Each input is internally biased to 1V, removing the need for external resistors. Both channels have rail-to-rail inputs and outputs, a gain of one, and are AC coupled with the use of one capacitor.

Replacing a discrete buffer solution with the LMH2180 provides many benefits: simplified board layout, minimized parasitic components, simplified BOM, design durability across multiple applications, simplification of clock paths, and the ability to reduce the number of clock signal generators in the system. The LMH2180 is produced in the tiny packages minimizing the required PCB space.

TYPICAL APPLICATION

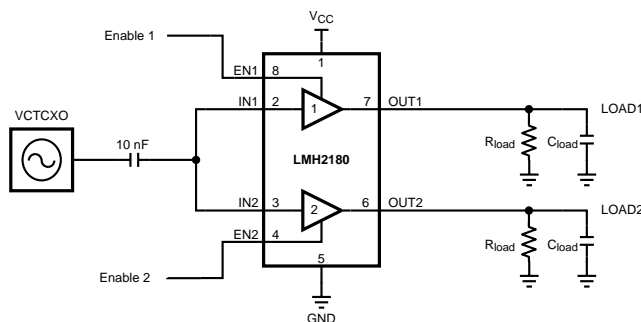

Please be aware that an important notice concerning availability, standard warranty, and use in critical applications of Texas Instruments semiconductor products and disclaimers thereto appears at the end of this data sheet.

All trademarks are the property of their respective owners.

CONNECTION DIAGRAMS

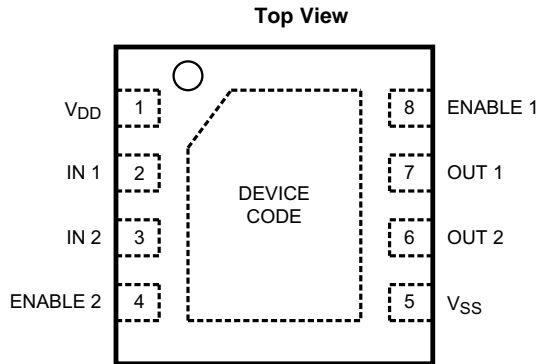

Figure 1. 8-Pin WSON Package
See Package Number NGW0008A or NGQ0008A

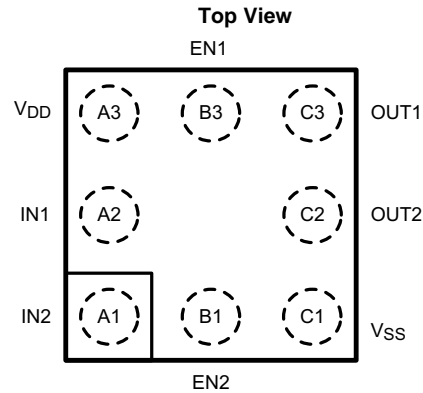

Figure 2. 8-Bump DSBGA Package
See Package Number YFQ0008AAA

PIN DESCRIPTIONS

Pin No. WSON	Pin No. DSBGA	Pin Name	Description
1	A3	V _{DD}	Voltage supply connection
2	A2	IN 1	Input 1
3	A1	IN 2	Input 2
4	B1	ENABLE 2	Enable buffer 2
5	C1	V _{SS}	Ground connection
6	C2	OUT 2	Output 2
7	C3	OUT 1	Output 1
8	B3	ENABLE 1	Enable buffer 1



These devices have limited built-in ESD protection. The leads should be shorted together or the device placed in conductive foam during storage or handling to prevent electrostatic damage to the MOS gates.

ABSOLUTE MAXIMUM RATINGS ⁽¹⁾⁽²⁾

Supply Voltages (V ⁺ – V ⁻)	5.5V
ESD Tolerance	
Human Body ⁽³⁾	2000V
Machine Model ⁽⁴⁾	200V
Charged Device Model	1000V
Storage Temperature Range	-65°C to 150°C
Junction Temperature ⁽⁵⁾	150°C
Soldering Information	
Infrared or Convection (35 sec.)	235°C

- (1) "Absolute Maximum Ratings" indicate limits beyond which damage to the device may occur, including inoperability and degradation of the device reliability and/or performance. Functional operation of the device and/or non-degradation at the Absolute Maximum Ratings or other conditions beyond those indicated in the Recommended Operating Conditions is not implied. The Recommended Operating Conditions indicate conditions at which the device is functional and the device should not be operated beyond such conditions. All voltages are measured with respect to the ground pin, unless otherwise specified.
- (2) If Military/Aerospace specified devices are required, please contact the Texas Instruments Sales Office/ Distributors for availability and specifications.
- (3) Human body model, applicable std. JESD22-A114C.
- (4) Machine model, applicable std. JESD22-A115-A.
- (5) The maximum power dissipation must be derated at elevated temperatures and is dictated by T_{J(MAX)}, θ_{JA}, and the ambient temperature T_A. The maximum allowable power dissipation is P_{DMAX} = (T_{JMAX} - T_A) / θ_{JA} or the number given in the *Absolute Maximum Ratings*, whichever is lower.

OPERATING RATINGS ⁽¹⁾

Supply Voltage ($V^+ - V^-$)	2.4V to 5.0V
Temperature Range ⁽²⁾⁽³⁾	-40°C to 85°C
Package Thermal Resistance ⁽²⁾⁽³⁾	
8-Pin WSON (θ_{JA})	217°C/W
8-Bump DSBGA (θ_{JA})	90°C/W

- (1) "Absolute Maximum Ratings" indicate limits beyond which damage to the device may occur, including inoperability and degradation of the device reliability and/or performance. Functional operation of the device and/or non-degradation at the Absolute Maximum Ratings or other conditions beyond those indicated in the Recommended Operating Conditions is not implied. The Recommended Operating Conditions indicate conditions at which the device is functional and the device should not be operated beyond such conditions. All voltages are measured with respect to the ground pin, unless otherwise specified.
- (2) The Electrical Characteristics tables show performance under the specified Recommended Operating Conditions except as otherwise modified by the Electrical Characteristics Conditions and/or Notes. Typical values represent typical performance as measured by production tests. Individual parts may vary.
- (3) The maximum power dissipation must be derated at elevated temperatures and is dictated by $T_{J(MAX)}$, θ_{JA} , and the ambient temperature T_A . The maximum allowable power dissipation is $P_{DMAX} = (T_{JMAX} - T_A) / \theta_{JA}$ or the number given in the *Absolute Maximum Ratings*, whichever is lower.

2.7V ELECTRICAL CHARACTERISTICS

Unless otherwise specified, all limits are specified for $T_A = 25^\circ\text{C}$, $V_{DD} = 2.7\text{V}$, $V_{SS} = 0\text{V}$, $V_{CM} = 1\text{V}$, $\text{Enable}_{1,2} = V_{DD}$, $C_L = 10\text{pF}$, $R_L = 30\text{k}\Omega$, Load is connected to V_{SS} , $C_{COUPLING} = 10\text{nF}$. **Boldface** limits apply at temperature range extremes of operating condition. ⁽¹⁾

Parameter		Test Conditions	Min ⁽²⁾	Typ ⁽³⁾	Max ⁽²⁾	Units
Frequency Domain Response						
SSBW	Small Signal Bandwidth	$V_{IN} = 100\text{mV}_{PP}$; -3 dB		78		MHz
LSBW	Large Signal Bandwidth	$V_{IN} = 1.0\text{V}_{PP}$; -3 dB		60		MHz
GFN	Gain Flatness < 0.1 dB	$f > 100\text{kHz}$		4.9		MHz
Distortion and Noise Performance						
Φ_n	Phase Noise	$V_{IN} = 1\text{V}_{PP}$, $f_C = 38.4\text{MHz}$, $\Delta f = 1\text{kHz}$		-123		dBc/Hz
		$V_{IN} = 1\text{V}_{PP}$, $f_C = 38.4\text{MHz}$, $\Delta f = 10\text{kHz}$		-132		dBc/Hz
e_n	Input-Referred Voltage Noise	$f = 1\text{MHz}$, $R_{SOURCE} = 50\Omega$		13		nV/ $\sqrt{\text{Hz}}$
$I_{SOLATION}$	Output to Input	$f = 1\text{MHz}$, $R_{SOURCE} = 50\Omega$		84		dB
CT	Crosstalk Rejection	$f = 38.4\text{MHz}$, $V_{IN} = 1\text{V}_{PP}$		41		dB
Time Domain Response						
t_r	Rise Time	0.1 V_{PP} Step (10-90%)		6		ns
t_f	Fall Time			5		ns
t_s	Settling Time to 0.1%	1 V_{PP} Step		120		ns
OS	Overshoot	0.1 V_{PP} Step		37		%
SR	Slew Rate ⁽⁴⁾	$V_{IN} = 2\text{V}_{PP}$		106		V/ μs
Static DC Performance						
I_S	Supply Current	Enable _{1,2} = V_{DD} ; No Load		2.3	2.7 2.9	mA
		Enable ₁ = V_{DD} , Enable ₂ = V_{SS} , No Load		1.3	1.5 1.6	mA
		Enable _{1,2} = V_{SS} ; No Load		30	41 46	μA
PSRR	Power Supply Rejection Ratio	DC (3.0V to 5.0V)	65 64	68		dB

- (1) The Electrical Characteristics tables show performance under the specified Recommended Operating Conditions except as otherwise modified by the Electrical Characteristics Conditions and/or Notes. Typical values represent typical performance as measured by production tests. Individual parts may vary.
- (2) Datasheet min/max limits are specified by test or statistical analysis.
- (3) Typical values represent the most likely parametric norms at $T_A = +25^\circ\text{C}$, and at the Recommended Operation Conditions at the time of product characterization.
- (4) Slew rate is the average of the rising and falling slew rates.

2.7V ELECTRICAL CHARACTERISTICS (continued)

Unless otherwise specified, all limits are specified for $T_A = 25^\circ\text{C}$, $V_{DD} = 2.7\text{V}$, $V_{SS} = 0\text{V}$, $V_{CM} = 1\text{V}$, $\text{Enable}_{1,2} = V_{DD}$, $C_L = 10\text{ pF}$, $R_L = 30\text{ k}\Omega$, Load is connected to V_{SS} , $C_{COUPLING} = 10\text{ nF}$. **Boldface** limits apply at temperature range extremes of operating condition.⁽¹⁾

Parameter		Test Conditions	Min ⁽²⁾	Typ ⁽³⁾	Max ⁽²⁾	Units
A_{CL}	Small Signal Voltage Gain	$V_{IN} = 0.2 V_{PP}$	0.95	1.0	1.05	V/V
V_{OS}	Output Offset Voltage			-0.5	17 18	mV
TC V_{OS}	Temperature Coefficient Output Offset Voltage ⁽⁵⁾			2.8		$\mu\text{V}/^\circ\text{C}$
R_{OUT}	Output Resistance	$f = 100\text{ kHz}$		0.6		Ω
		$f = 38.4\text{ MHz}$		166		
		disabled	High Impedance			
Miscellaneous Performance						
R_{IN}	Input Resistance per Buffer	Enable = V_{DD}		137		k Ω
		Enable = V_{SS}		137		
C_{IN}	Input Capacitance per Buffer	Enable = V_{DD}		1.3		pF
		Enable = V_{SS}		1.3		
Z_{IN}	Input Impedance	$f = 38.4\text{ MHz}$, Enable = V_{DD}		4.5		k Ω
		$f = 38.4\text{ MHz}$, Enable = V_{SS}		4.2		
V_O	Output Swing Positive	$V_{IN} = V_{DD}$	2.66 2.65	2.69		V
	Output Swing Negative	$V_{IN} = V_{SS}$		19	35 37	mV
I_{SC}	Output Short-Circuit Current ⁽⁶⁾⁽⁷⁾	Sourcing, $V_{IN} = V_{DD}$, $V_{OUT} = V_{SS}$	-21 -18	-25		mA
		Sinking, $V_{IN} = V_{SS}$, $V_{OUT} = V_{DD}$	23 15	25		
V_{en_hmin}	Enable High Active Minimum Voltage			1.2		V
V_{en_lmax}	Enable Low Inactive Maximum Voltage			0.6		

(5) Average Temperature Coefficient is determined by dividing the changing in a parameter at temperature extremes by the total temperature change.

(6) Short-Circuit test is a momentary test. Continuous short circuit operation at elevated ambient temperature can result in exceeding the maximum allowed junction temperature of 150°C .

(7) Positive current corresponds to current flowing into the device.

5V ELECTRICAL CHARACTERISTICS

Unless otherwise specified, all limits are specified for $T_A = 25^\circ\text{C}$, $V_{DD} = 5\text{V}$, $V_{SS} = 0\text{V}$, $V_{CM} = 1\text{V}$, $\text{Enable}_{1,2} = V_{DD}$, $C_L = 10\text{ pF}$, $R_L = 30\text{ k}\Omega$, Load is connected to V_{SS} , $C_{COUPLING} = 10\text{ nF}$. **Boldface** limits apply at temperature range extremes of operating condition.⁽¹⁾

Parameter		Test Conditions	Min ⁽²⁾	Typ ⁽³⁾	Max ⁽²⁾	Units
Frequency Domain Response						
SSBW	Small Signal Bandwidth	$V_{IN} = 100\text{ mV}_{PP}$; -3 dB		87		MHz
LSBW	Large Signal Bandwidth	$V_{IN} = 1.0\text{ V}_{PP}$; -3 dB		68		MHz
GFN	Gain Flatness < 0.1 dB	$f > 100\text{ kHz}$		25		MHz
Distortion and Noise Performance						
ϕ_n	Phase Noise	$V_{IN} = 1\text{ V}_{PP}$, $f_C = 38.4\text{ MHz}$, $\Delta f = 1\text{ kHz}$		-123		dBc/Hz
		$V_{IN} = 1\text{ V}_{PP}$, $f_C = 38.4\text{ MHz}$, $\Delta f = 10\text{ kHz}$		-132		dBc/Hz

(1) The Electrical Characteristics tables show performance under the specified Recommended Operating Conditions except as otherwise modified by the Electrical Characteristics Conditions and/or Notes. Typical values represent typical performance as measured by production tests. Individual parts may vary.

(2) Datasheet min/max limits are specified by test or statistical analysis.

(3) Typical values represent the most likely parametric norms at $T_A = +25^\circ\text{C}$, and at the Recommended Operation Conditions at the time of product characterization.

5V ELECTRICAL CHARACTERISTICS (continued)

Unless otherwise specified, all limits are specified for $T_A = 25^\circ\text{C}$, $V_{DD} = 5\text{V}$, $V_{SS} = 0\text{V}$, $V_{CM} = 1\text{V}$, $\text{Enable}_{1,2} = V_{DD}$, $C_L = 10\text{ pF}$, $R_L = 30\text{ k}\Omega$, Load is connected to V_{SS} , $C_{COUPLING} = 10\text{ nF}$. **Boldface** limits apply at temperature range extremes of operating condition.⁽¹⁾

Parameter		Test Conditions	Min ⁽²⁾	Typ ⁽³⁾	Max ⁽²⁾	Units
e_n	Input-Referred Voltage Noise	$f = 1\text{ MHz}$, $R_{SOURCE} = 50\Omega$		12		nV/ $\sqrt{\text{Hz}}$
$I_{SOLATION}$	Output to Input	$f = 1\text{ MHz}$, $R_{SOURCE} = 50\Omega$		84		dB
CT	Crosstalk Rejection	$f = 38.4\text{ MHz}$, $P_{IN} = 0\text{ dBm}$		59		dB
Time Domain Response						
t_r	Rise Time	0.1 V_{PP} Step (10-90%)		6		ns
t_f	Fall Time			6		ns
t_s	Settling Time to 0.1%	1 V_{PP} Step		70		ns
OS	Overshoot	0.1 V_{PP} Step		13		%
SR	Slew Rate ⁽⁴⁾	$V_{IN} = 2\text{ }V_{PP}$		124		V/ μs
Static DC Performance						
I_S	Supply Current	$\text{Enable}_{1,2} = V_{DD}$; No Load		3.4	4.0 4.1	mA
		$\text{Enable}_1 = V_{DD}$, $\text{Enable}_2 = V_{SS}$; No Load		1.8	2.2 2.3	mA
		$\text{Enable}_{1,2} = V_{SS}$; No Load		32	43 49	μA
PSRR	Power Supply Rejection Ratio	DC (3.0V to 5.0V)	65 64	68		dB
A_{CL}	Small Signal Voltage Gain	$V_{IN} = 0.2\text{ }V_{PP}$	0.95	1.0	1.05	V/V
V_{OS}	Output Offset Voltage			-1.4	21 22	mV
TC V_{OS}	Temperature Coefficient Output Offset Voltage ⁽⁵⁾			2.4		$\mu\text{V}/^\circ\text{C}$
R_{OUT}	Output Resistance	$f = 100\text{ kHz}$		0.5		Ω
		$f = 38.4\text{ MHz}$		126		
		disabled		High Impedance		
Miscellaneous Performance						
R_{IN}	Input Resistance per Buffer	$\text{Enable} = V_{DD}$		138		k Ω
		$\text{Enable} = V_{SS}$		138		
C_{IN}	Input Capacitance per Buffer	$\text{Enable} = V_{DD}$		1.3		pF
		$\text{Enable} = V_{SS}$		1.3		
Z_{IN}	Input Impedance	$f = 38.4\text{ MHz}$, $\text{Enable} = V_{DD}$		4.3		k Ω
		$f = 38.4\text{ MHz}$, $\text{Enable} = V_{SS}$		4.2		
V_O	Output Swing Positive	$V_{IN} = V_{DD}$	4.96 4.95	4.99		V
	Output Swing Negative	$V_{IN} = V_{SS}$		10	35 50	mV
I_{SC}	Output Short-Circuit Current ⁽⁶⁾⁽⁷⁾	Sourcing, $V_{IN} = V_{DD}$, $V_{OUT} = V_{SS}$	-80 -62	-90		mA
		Sinking, $V_{IN} = V_{SS}$, $V_{OUT} = V_{DD}$	60 43	65		
V_{en_hmin}	Enable High Active Minimum Voltage			1.2		V
V_{en_lmax}	Enable Low Inactive Maximum Voltage			0.6		

(4) Slew rate is the average of the rising and falling slew rates.

(5) Average Temperature Coefficient is determined by dividing the changing in a parameter at temperature extremes by the total temperature change.

(6) Short-Circuit test is a momentary test. Continuous short circuit operation at elevated ambient temperature can result in exceeding the maximum allowed junction temperature of 150°C .

(7) Positive current corresponds to current flowing into the device.

BLOCK DIAGRAM

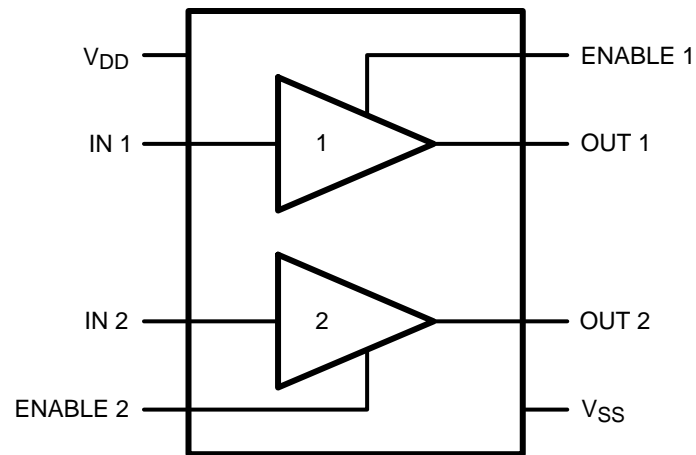

TYPICAL PERFORMANCE CHARACTERISTICS

$T_A = 25^\circ\text{C}$, $V_{DD} = 2.7\text{V}$, $V_{SS} = 0\text{V}$, $\text{Enable}_{1,2} = V_{DD}$, $C_L = 10\text{ pF}$, $R_L = 30\text{ k}\Omega$ and $C_{\text{COUPLING}} = 10\text{ nF}$, unless otherwise specified.

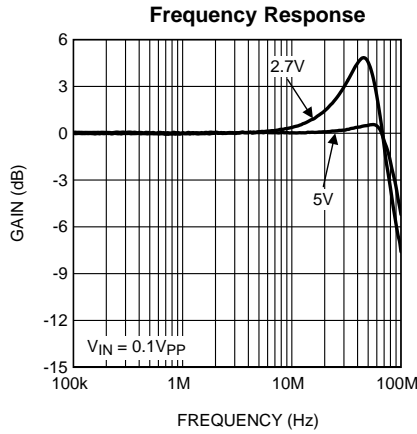

Figure 3.

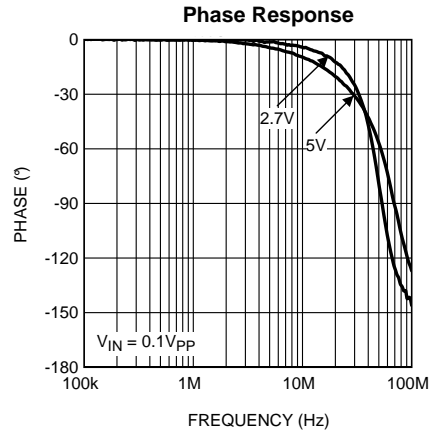

Figure 4.

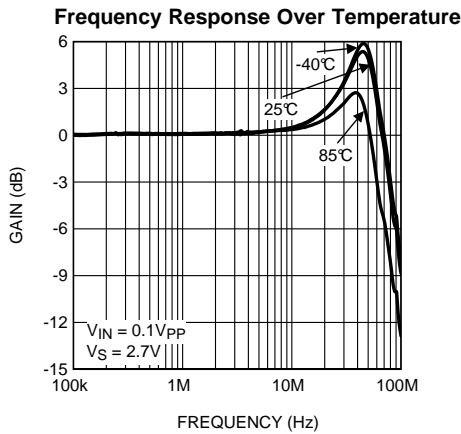

Figure 5.

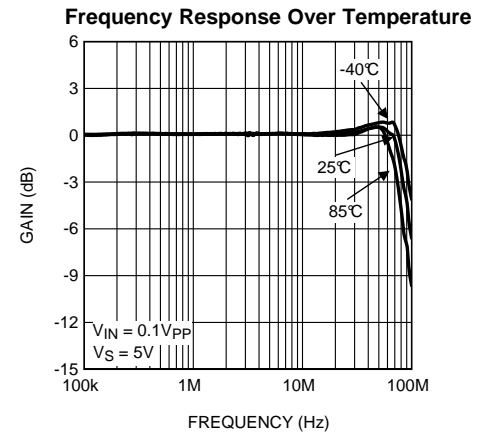

Figure 6.

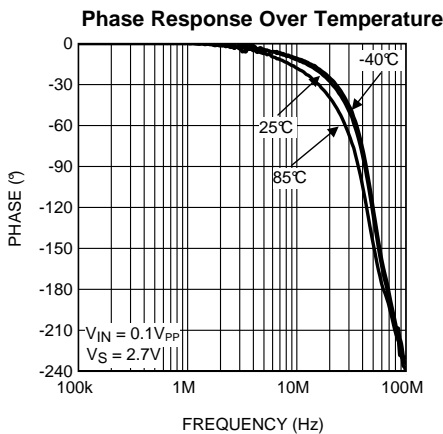

Figure 7.

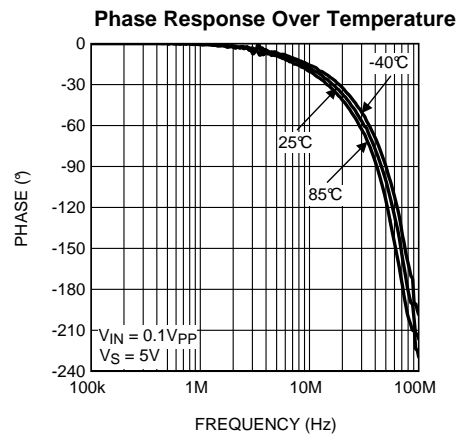

Figure 8.

TYPICAL PERFORMANCE CHARACTERISTICS (continued)

$T_A = 25^\circ\text{C}$, $V_{DD} = 2.7\text{V}$, $V_{SS} = 0\text{V}$, $\text{Enable}_{1,2} = V_{DD}$, $C_L = 10\text{ pF}$, $R_L = 30\text{ k}\Omega$ and $C_{\text{COUPLING}} = 10\text{ nF}$, unless otherwise specified.

Large Signal Bandwidth

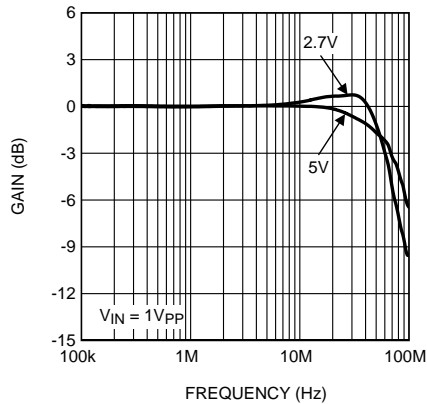

Figure 9.

Gain Flatness < 0.1 dB (GFN)

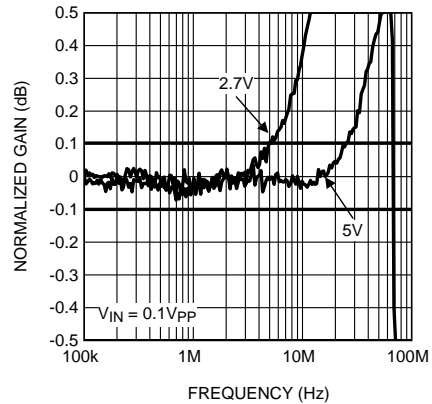

Figure 10.

Voltage Noise

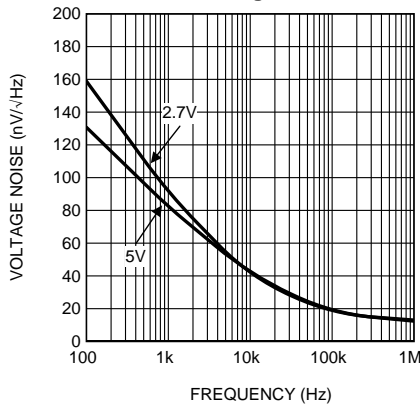

Figure 11.

Phase Noise

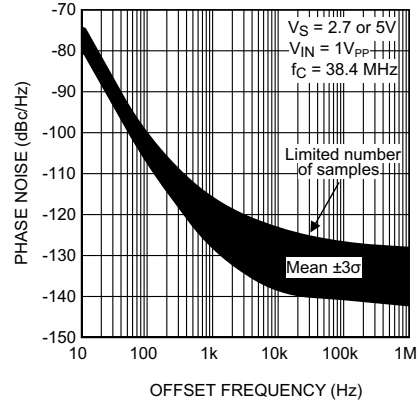

Figure 12.

Isolation Output to Input vs. Frequency

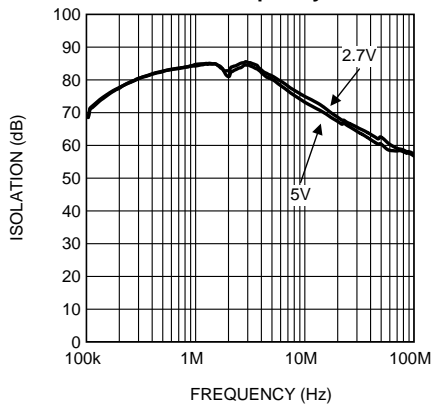

Figure 13.

Crosstalk Rejection vs. Frequency

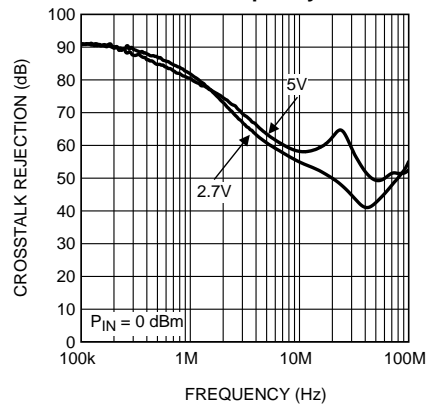

Figure 14.

TYPICAL PERFORMANCE CHARACTERISTICS (continued)

$T_A = 25^\circ\text{C}$, $V_{DD} = 2.7\text{V}$, $V_{SS} = 0\text{V}$, $\text{Enable}_{1,2} = V_{DD}$, $C_L = 10\text{ pF}$, $R_L = 30\text{ k}\Omega$ and $C_{\text{COUPLING}} = 10\text{ nF}$, unless otherwise specified.

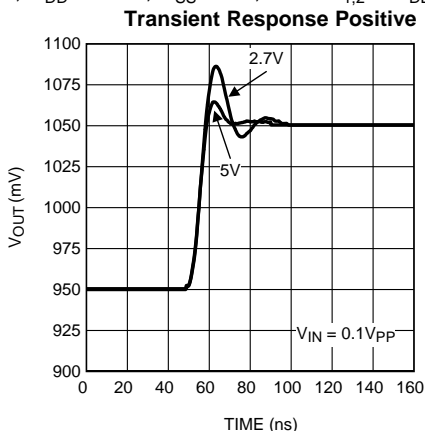

Figure 15.

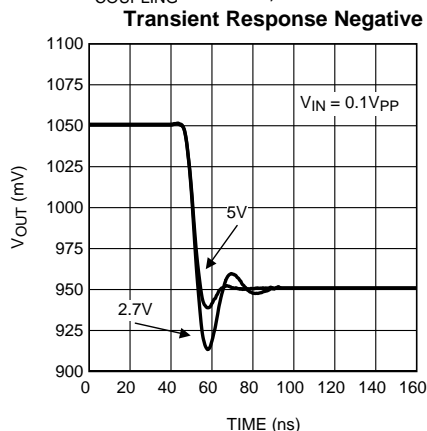

Figure 16.

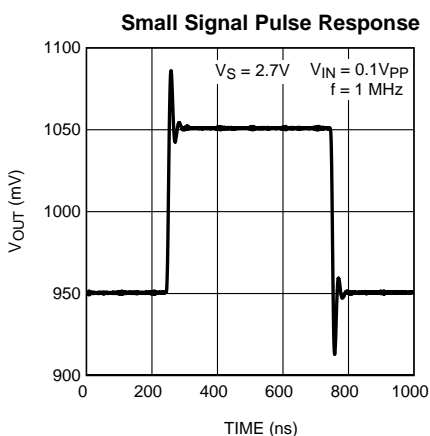

Figure 17.

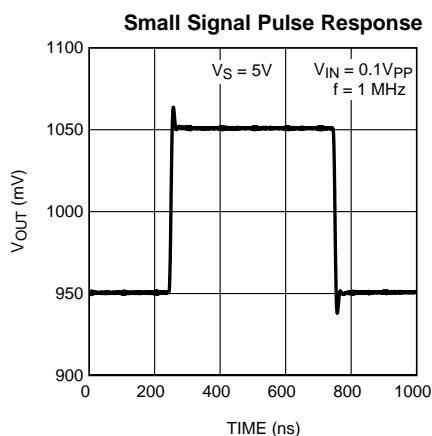

Figure 18.

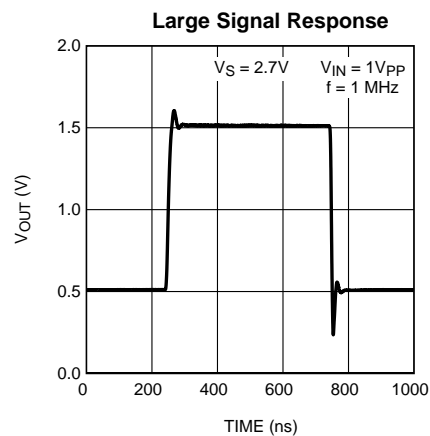

Figure 19.

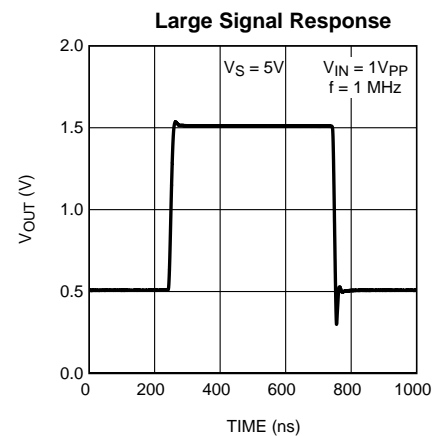

Figure 20.

TYPICAL PERFORMANCE CHARACTERISTICS (continued)

$T_A = 25^\circ\text{C}$, $V_{DD} = 2.7\text{V}$, $V_{SS} = 0\text{V}$, $\text{Enable}_{1,2} = V_{DD}$, $C_L = 10\text{ pF}$, $R_L = 30\text{ k}\Omega$ and $C_{\text{COUPLING}} = 10\text{ nF}$, unless otherwise specified.

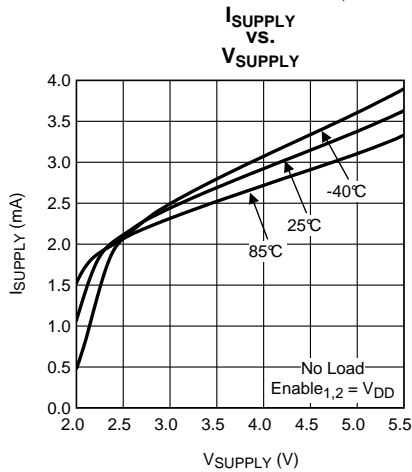

Figure 21.

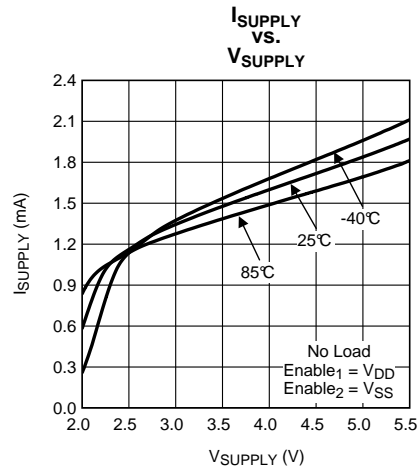

Figure 22.

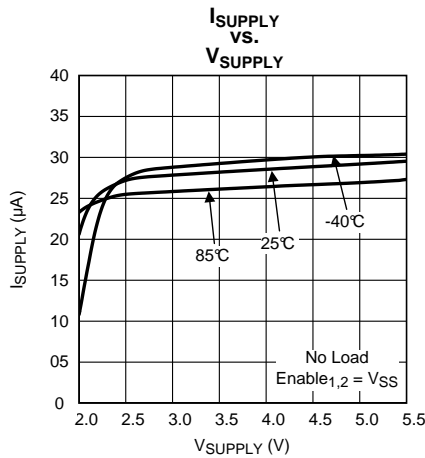

Figure 23.

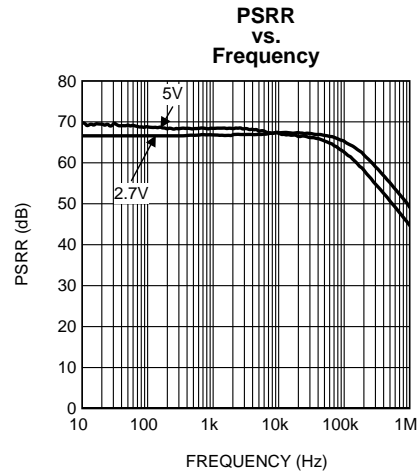

Figure 24.

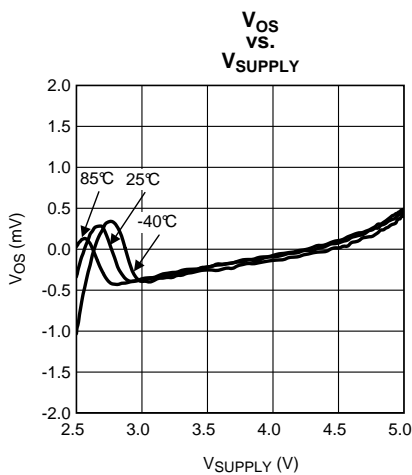

Figure 25.

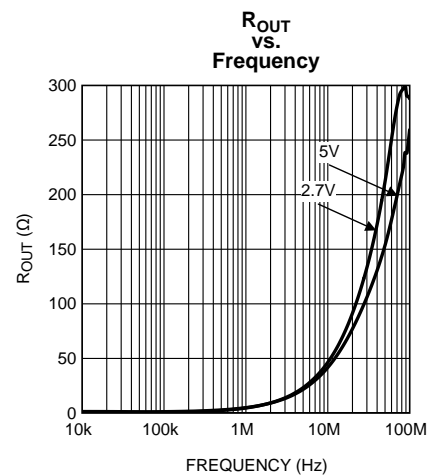

Figure 26.

TYPICAL PERFORMANCE CHARACTERISTICS (continued)

$T_A = 25^\circ\text{C}$, $V_{DD} = 2.7\text{V}$, $V_{SS} = 0\text{V}$, $\text{Enable}_{1,2} = V_{DD}$, $C_L = 10\text{ pF}$, $R_L = 30\text{ k}\Omega$ and $C_{\text{COUPLING}} = 10\text{ nF}$, unless otherwise specified.

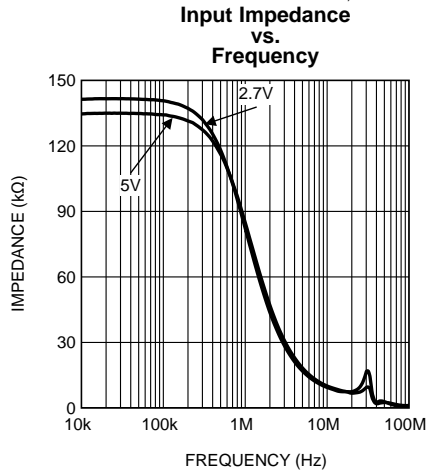

Figure 27.

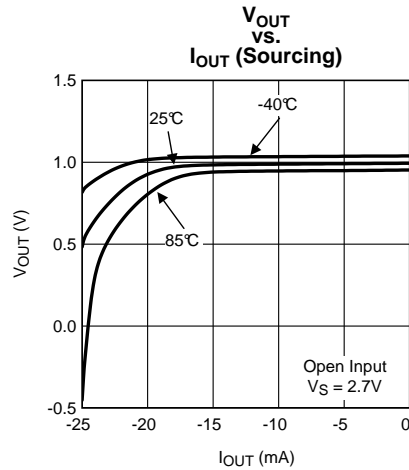

Figure 28.

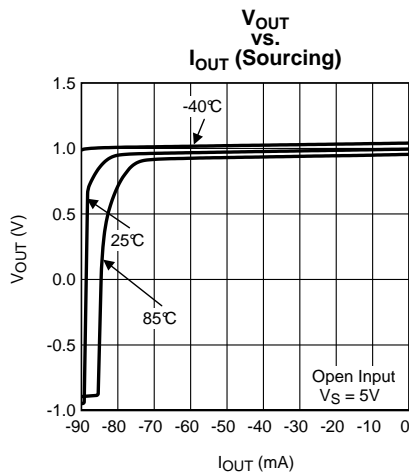

Figure 29.

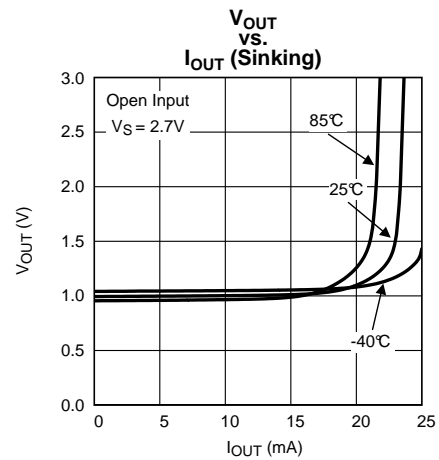

Figure 30.

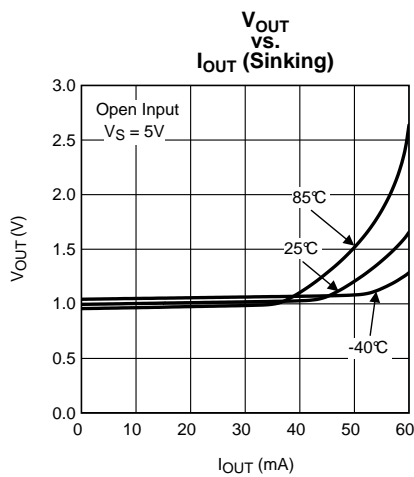

Figure 31.

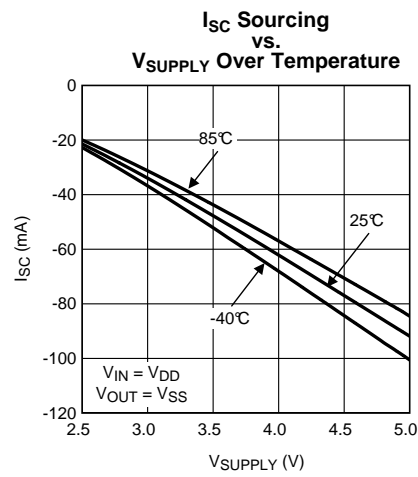
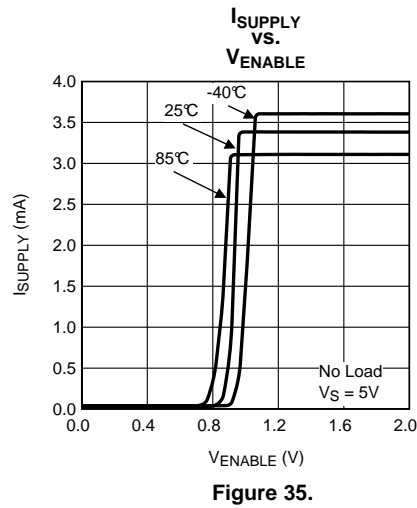
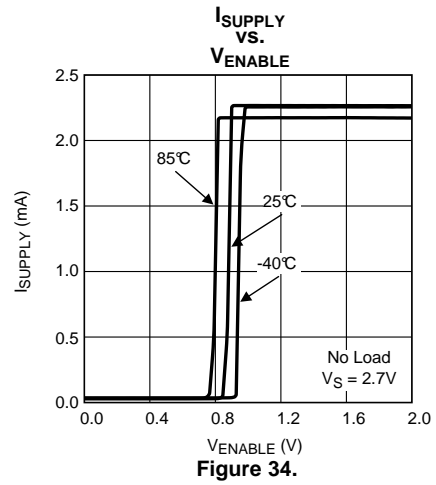
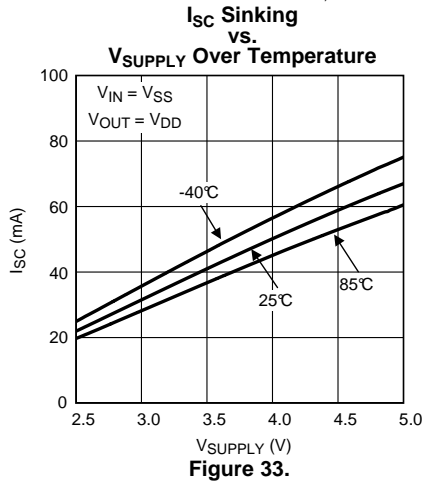

Figure 32.

TYPICAL PERFORMANCE CHARACTERISTICS (continued)

$T_A = 25^\circ\text{C}$, $V_{DD} = 2.7\text{V}$, $V_{SS} = 0\text{V}$, $\text{Enable}_{1,2} = V_{DD}$, $C_L = 10\text{ pF}$, $R_L = 30\text{ k}\Omega$ and $C_{\text{COUPLING}} = 10\text{ nF}$, unless otherwise specified.



APPLICATION INFORMATION

GENERAL

The LMH2180 is designed to minimize the effects of spurious signals from the base chip to the oscillator. Also the influence of varying load resistance and capacitance to the oscillator is minimized, while the drive capability is increased.

The inputs of the LMH2180 are internally biased at 1V, making AC coupling possible without external bias resistors.

To optimize current consumption, a buffer that is not in use can be disabled by connecting its enable pin to V_{SS} .

The LMH2180 has no internal ground reference; therefore, either single or split supply configurations can be used.

The LMH2180 is an easy replacement for discrete circuitry. It simplifies board layout and minimizes the effect of layout related parasitic components.

INPUT CONFIGURATION

The internal 1V input biasing allows AC coupling of the input signal. This biasing avoids the use of external resistors, as depicted in [Figure 36](#). The biasing prevents a large DC load at the oscillator's output that creates a load impedance and may affect its oscillating frequency. As a result of this biasing, the maximum amplitude of the AC signal is $2V_{PP}$.

The coupling capacitance $C1$ should be large enough to let the AC signal pass. This is a unity gain buffer with rail-to-rail inputs and outputs.

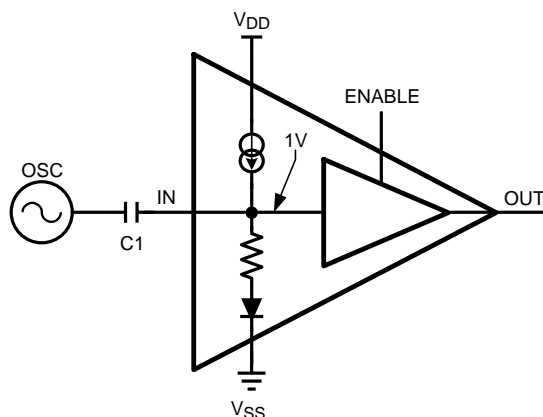

Figure 36. Input Configuration

FREQUENCY PULLING

Frequency pulling is the frequency variation of an oscillator caused by a varying load. In the typical application, the load of the oscillator is a fixed capacitor ($C1$) in series with the input impedance of the buffer.

To keep the input impedance as constant as possible, the input is biased at 1V, even when the part is disabled. A simplified schematic of the input configuration is shown in [Figure 36](#).

ISOLATION AND CROSSTALK

Output to input isolation prevents the clock signal of the oscillator from being affected by spurious signals generated by the digital blocks behind the output buffer. See [Figure 13](#).

A block diagram of the isolation is shown in [Figure 37](#). Crosstalk rejection between buffers prevents signals from affecting each other. [Figure 37](#) shows a Baseband IC and a Bluetooth module as an example. See [Figure 14](#) for more information.

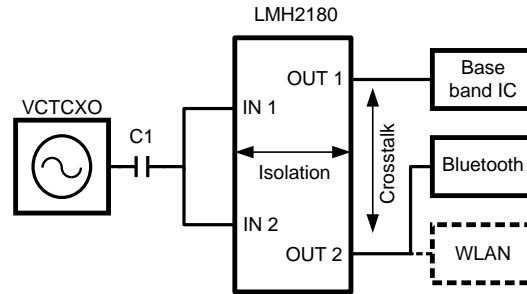

Figure 37. Isolation Block Diagram

DRIVING CAPACITIVE LOADS

Each buffer can drive a capacitive load. Be aware that every capacitor directly connected to the output becomes part of the loop of the buffer. In most applications the load consists of the capacitance of copper tracks and the input capacitance of the application blocks. Capacitance reduces the gain/phase margin and decreases the stability. This leads to peaking in the frequency response and in extreme situations oscillations can occur. To drive a large capacitive load it is recommended to include a series resistor between the buffer and the load capacitor. The best value for this isolation resistance can be found by experimentation.

The LMH2180 datasheet reflects measurements with capacitive loads of 10 pF at the output of the buffers. Most common applications will probably use a lower capacitive load, which will result in lower peaking and significantly greater bandwidth, see [Figure 38](#).

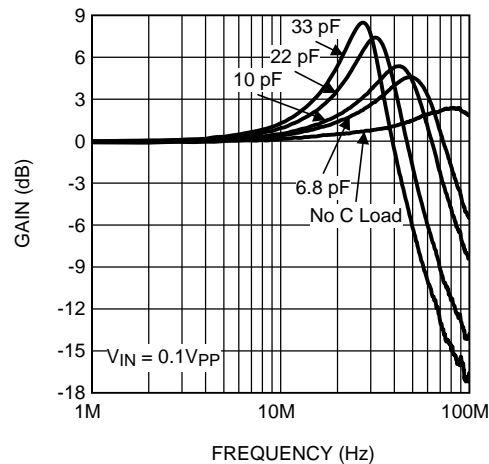

Figure 38. Bandwidth and Peaking

PHASE NOISE

A clock buffer adds noise to the clock signal. This noise causes uncertainty in the phase of the clock signal. This uncertainty is described by jitter (time domain) or phase noise (frequency domain). Communication systems, such as Wireless LAN, require a low jitter/phase noise clock signal to obtain a low Bit Error Rate. [Figure 39](#) shows the frequency domain representation of a clock signal with frequency f_C . Without Phase Noise the entire signal power would only be located at the frequency f_C . Phase Noise spreads some of the power to adjacent frequencies. Phase Noise is usually specified in dBc/Hz at a given frequency offset Δf from the carrier, where dBc is the power level in dB relative to the carrier. The noise power is measured within a 1 Hz bandwidth.

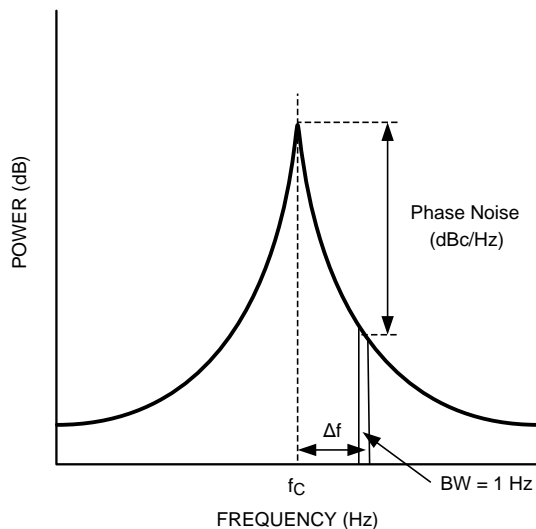

Figure 39. Phase Noise

Figure 40 shows the setup used to measure the LMH2180 phase noise. The clock driving the LMH2180 is a state of the art 38.4MHz TCXO. Both the TCXO phase noise and the phase noise at the LMH2180 output were measured. At offset frequencies of 1 kHz and higher from the carrier, the TCXO phase noise is sufficiently low to accurately calculate the LMH2180 contribution to the phase noise at the output. The LMH6559, whose phase noise contribution can be neglected, is used to drive the 50Ω input impedance of the Signal Source Analyzer.

LAYOUT DESIGN RECOMMENDATION

Careful consideration during circuit design and PCB layout will eliminate problems and will optimize the performance of the LMH2180. It is best to have the same ground plane on the PCB for all decoupling and other ground connections.

To ensure a clean supply voltage it is best to place decoupling capacitors close to the LMH2180, between V_{DD} and V_{SS}.

Another important issue is the value of the components, because this also determines the sensitivity to disturbances. Resistor values have to be low enough to avoid a significant noise contribution and large enough to avoid a significant increase in power consumption while loading inputs or outputs to heavily.

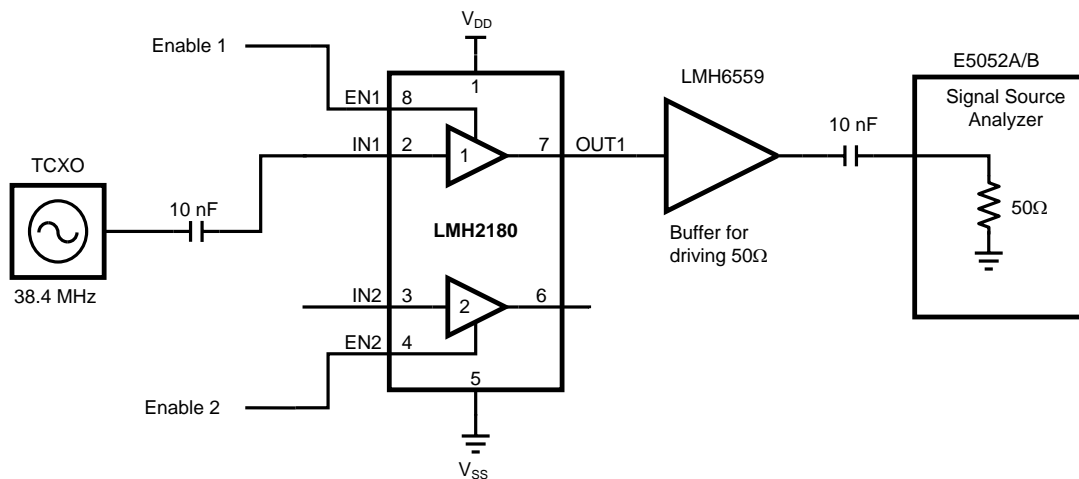

Figure 40. Measurement Setup

REVISION HISTORY

Changes from Revision C (March 2013) to Revision D	Page
• Changed layout of National Data Sheet to TI format	15

PACKAGING INFORMATION

Orderable Device	Status (1)	Package Type	Package Drawing	Pins	Package Qty	Eco Plan (2)	Lead/Ball Finish (6)	MSL Peak Temp (3)	Op Temp (°C)	Device Marking (4/5)	Samples
LMH2180SD/NOPB	ACTIVE	WSO	NGQ	8	1000	Green (RoHS & no Sb/Br)	CU SN	Level-1-260C-UNLIM	-40 to 85	2180S	Samples
LMH2180SDE/NOPB	ACTIVE	WSO	NGQ	8	250	Green (RoHS & no Sb/Br)	CU SN	Level-1-260C-UNLIM	-40 to 85	2180S	Samples
LMH2180TM/NOPB	ACTIVE	DSBGA	YFQ	8	250	Green (RoHS & no Sb/Br)	SNAGCU	Level-1-260C-UNLIM		A	Samples
LMH2180TMX/NOPB	ACTIVE	DSBGA	YFQ	8	3000	Green (RoHS & no Sb/Br)	SNAGCU	Level-1-260C-UNLIM		A	Samples

(1) The marketing status values are defined as follows:

ACTIVE: Product device recommended for new designs.

LIFEBUY: TI has announced that the device will be discontinued, and a lifetime-buy period is in effect.

NRND: Not recommended for new designs. Device is in production to support existing customers, but TI does not recommend using this part in a new design.

PREVIEW: Device has been announced but is not in production. Samples may or may not be available.

OBSELETE: TI has discontinued the production of the device.

(2) **RoHS:** TI defines "RoHS" to mean semiconductor products that are compliant with the current EU RoHS requirements for all 10 RoHS substances, including the requirement that RoHS substance do not exceed 0.1% by weight in homogeneous materials. Where designed to be soldered at high temperatures, "RoHS" products are suitable for use in specified lead-free processes. TI may reference these types of products as "Pb-Free".

RoHS Exempt: TI defines "RoHS Exempt" to mean products that contain lead but are compliant with EU RoHS pursuant to a specific EU RoHS exemption.

Green: TI defines "Green" to mean the content of Chlorine (Cl) and Bromine (Br) based flame retardants meet JS709B low halogen requirements of <=1000ppm threshold. Antimony trioxide based flame retardants must also meet the <=1000ppm threshold requirement.

(3) MSL, Peak Temp. - The Moisture Sensitivity Level rating according to the JEDEC industry standard classifications, and peak solder temperature.

(4) There may be additional marking, which relates to the logo, the lot trace code information, or the environmental category on the device.

(5) Multiple Device Markings will be inside parentheses. Only one Device Marking contained in parentheses and separated by a "-" will appear on a device. If a line is indented then it is a continuation of the previous line and the two combined represent the entire Device Marking for that device.

(6) Lead/Ball Finish - Orderable Devices may have multiple material finish options. Finish options are separated by a vertical ruled line. Lead/Ball Finish values may wrap to two lines if the finish value exceeds the maximum column width.

Important Information and Disclaimer:The information provided on this page represents TI's knowledge and belief as of the date that it is provided. TI bases its knowledge and belief on information provided by third parties, and makes no representation or warranty as to the accuracy of such information. Efforts are underway to better integrate information from third parties. TI has taken and

continues to take reasonable steps to provide representative and accurate information but may not have conducted destructive testing or chemical analysis on incoming materials and chemicals. TI and TI suppliers consider certain information to be proprietary, and thus CAS numbers and other limited information may not be available for release.

In no event shall TI's liability arising out of such information exceed the total purchase price of the TI part(s) at issue in this document sold by TI to Customer on an annual basis.

TAPE AND REEL INFORMATION

QUADRANT ASSIGNMENTS FOR PIN 1 ORIENTATION IN TAPE



*All dimensions are nominal

Device	Package Type	Package Drawing	Pins	SPQ	Reel Diameter (mm)	Reel Width W1 (mm)	A0 (mm)	B0 (mm)	K0 (mm)	P1 (mm)	W (mm)	Pin1 Quadrant
LMH2180SD/NOPB	WSO	NGQ	8	1000	178.0	12.4	3.3	3.3	1.0	8.0	12.0	Q1
LMH2180SDE/NOPB	WSO	NGQ	8	250	178.0	12.4	3.3	3.3	1.0	8.0	12.0	Q1
LMH2180TM/NOPB	DSBGA	YFQ	8	250	178.0	8.4	1.35	1.35	0.76	4.0	8.0	Q1
LMH2180TMX/NOPB	DSBGA	YFQ	8	3000	178.0	8.4	1.35	1.35	0.76	4.0	8.0	Q1

TAPE AND REEL BOX DIMENSIONS

*All dimensions are nominal

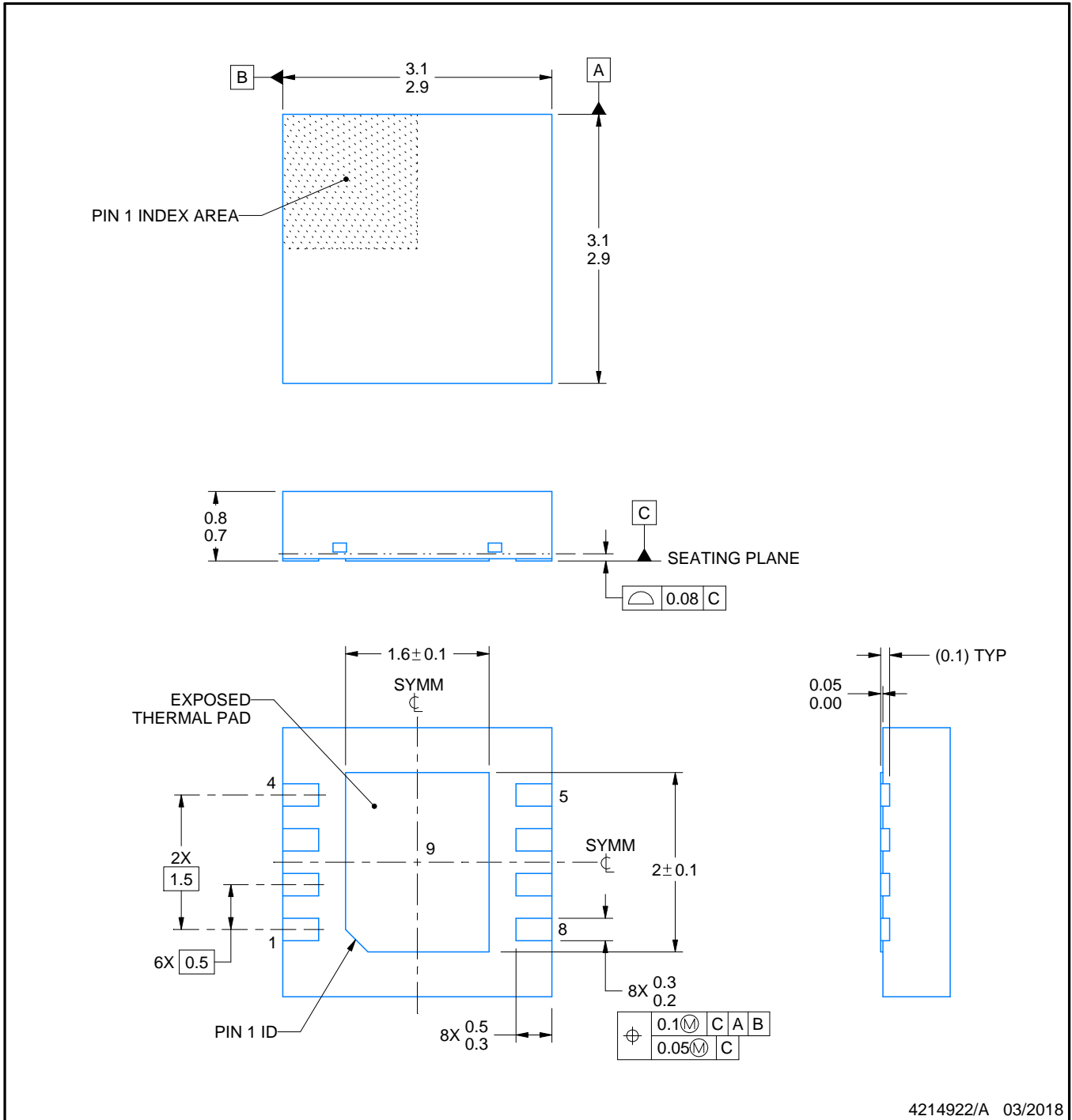
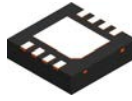
Device	Package Type	Package Drawing	Pins	SPQ	Length (mm)	Width (mm)	Height (mm)
LMH2180SD/NOPB	WSON	NGQ	8	1000	210.0	185.0	35.0
LMH2180SDE/NOPB	WSON	NGQ	8	250	210.0	185.0	35.0
LMH2180TM/NOPB	DSBGA	YFQ	8	250	210.0	185.0	35.0
LMH2180TMX/NOPB	DSBGA	YFQ	8	3000	210.0	185.0	35.0



4214922/A 03/2018

NOTES:

1. All linear dimensions are in millimeters. Any dimensions in parenthesis are for reference only. Dimensioning and tolerancing per ASME Y14.5M.
2. This drawing is subject to change without notice.
3. The package thermal pad must be soldered to the printed circuit board for thermal and mechanical performance.

EXAMPLE BOARD LAYOUT

NGQ0008A

WSON - 0.8 mm max height

PLASTIC SMALL OUTLINE - NO LEAD

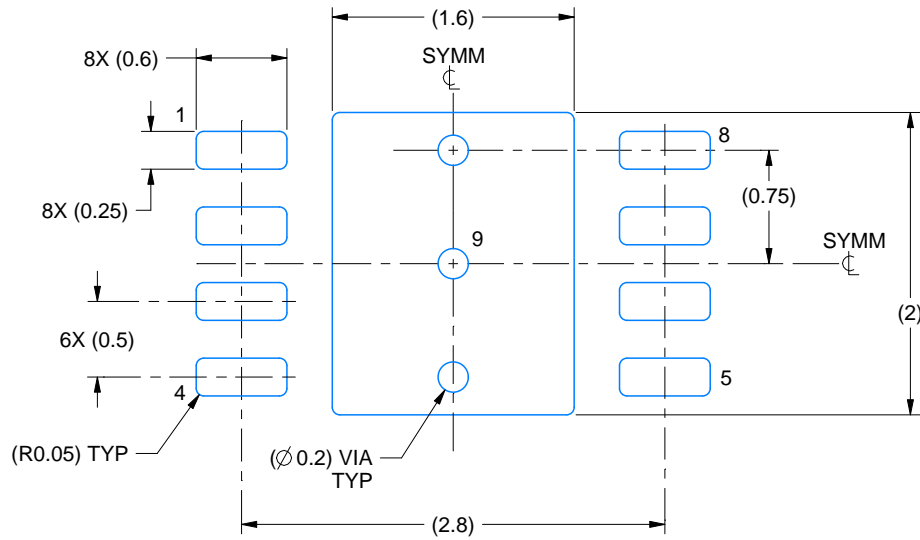

LAND PATTERN EXAMPLE
EXPOSED METAL SHOWN
SCALE:20X

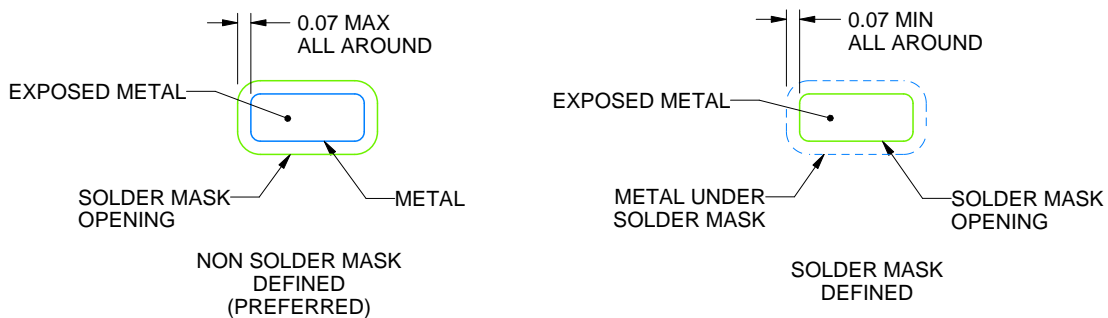

SOLDER MASK DETAILS

4214922/A 03/2018

NOTES: (continued)

4. This package is designed to be soldered to a thermal pad on the board. For more information, see Texas Instruments literature number SLUA271 (www.ti.com/lit/sluea271).
5. Vias are optional depending on application, refer to device data sheet. If any vias are implemented, refer to their locations shown on this view. It is recommended that vias under paste be filled, plugged or tented.

EXAMPLE STENCIL DESIGN

NGQ0008A

WSON - 0.8 mm max height

PLASTIC SMALL OUTLINE - NO LEAD

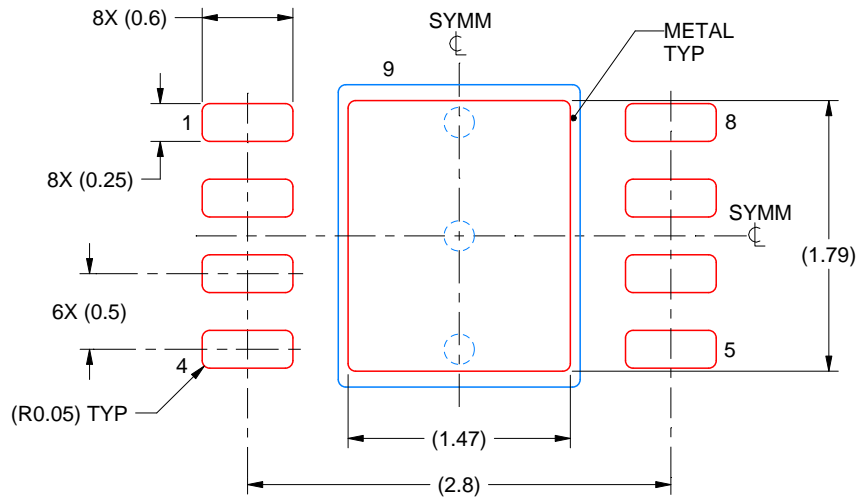

SOLDER PASTE EXAMPLE
BASED ON 0.1 mm THICK STENCIL

EXPOSED PAD 9:
82% PRINTED SOLDER COVERAGE BY AREA UNDER PACKAGE
SCALE:20X

4214922/A 03/2018

NOTES: (continued)

6. Laser cutting apertures with trapezoidal walls and rounded corners may offer better paste release. IPC-7525 may have alternate design recommendations.

IMPORTANT NOTICE

Texas Instruments Incorporated (TI) reserves the right to make corrections, enhancements, improvements and other changes to its semiconductor products and services per JESD46, latest issue, and to discontinue any product or service per JESD48, latest issue. Buyers should obtain the latest relevant information before placing orders and should verify that such information is current and complete.

TI's published terms of sale for semiconductor products (<http://www.ti.com/sc/docs/stdterms.htm>) apply to the sale of packaged integrated circuit products that TI has qualified and released to market. Additional terms may apply to the use or sale of other types of TI products and services.

Reproduction of significant portions of TI information in TI data sheets is permissible only if reproduction is without alteration and is accompanied by all associated warranties, conditions, limitations, and notices. TI is not responsible or liable for such reproduced documentation. Information of third parties may be subject to additional restrictions. Resale of TI products or services with statements different from or beyond the parameters stated by TI for that product or service voids all express and any implied warranties for the associated TI product or service and is an unfair and deceptive business practice. TI is not responsible or liable for any such statements.

Buyers and others who are developing systems that incorporate TI products (collectively, "Designers") understand and agree that Designers remain responsible for using their independent analysis, evaluation and judgment in designing their applications and that Designers have full and exclusive responsibility to assure the safety of Designers' applications and compliance of their applications (and of all TI products used in or for Designers' applications) with all applicable regulations, laws and other applicable requirements. Designer represents that, with respect to their applications, Designer has all the necessary expertise to create and implement safeguards that (1) anticipate dangerous consequences of failures, (2) monitor failures and their consequences, and (3) lessen the likelihood of failures that might cause harm and take appropriate actions. Designer agrees that prior to using or distributing any applications that include TI products, Designer will thoroughly test such applications and the functionality of such TI products as used in such applications.

TI's provision of technical, application or other design advice, quality characterization, reliability data or other services or information, including, but not limited to, reference designs and materials relating to evaluation modules, (collectively, "TI Resources") are intended to assist designers who are developing applications that incorporate TI products; by downloading, accessing or using TI Resources in any way, Designer (individually or, if Designer is acting on behalf of a company, Designer's company) agrees to use any particular TI Resource solely for this purpose and subject to the terms of this Notice.

TI's provision of TI Resources does not expand or otherwise alter TI's applicable published warranties or warranty disclaimers for TI products, and no additional obligations or liabilities arise from TI providing such TI Resources. TI reserves the right to make corrections, enhancements, improvements and other changes to its TI Resources. TI has not conducted any testing other than that specifically described in the published documentation for a particular TI Resource.

Designer is authorized to use, copy and modify any individual TI Resource only in connection with the development of applications that include the TI product(s) identified in such TI Resource. NO OTHER LICENSE, EXPRESS OR IMPLIED, BY ESTOPPEL OR OTHERWISE TO ANY OTHER TI INTELLECTUAL PROPERTY RIGHT, AND NO LICENSE TO ANY TECHNOLOGY OR INTELLECTUAL PROPERTY RIGHT OF TI OR ANY THIRD PARTY IS GRANTED HEREIN, including but not limited to any patent right, copyright, mask work right, or other intellectual property right relating to any combination, machine, or process in which TI products or services are used. Information regarding or referencing third-party products or services does not constitute a license to use such products or services, or a warranty or endorsement thereof. Use of TI Resources may require a license from a third party under the patents or other intellectual property of the third party, or a license from TI under the patents or other intellectual property of TI.

TI RESOURCES ARE PROVIDED "AS IS" AND WITH ALL FAULTS. TI DISCLAIMS ALL OTHER WARRANTIES OR REPRESENTATIONS, EXPRESS OR IMPLIED, REGARDING RESOURCES OR USE THEREOF, INCLUDING BUT NOT LIMITED TO ACCURACY OR COMPLETENESS, TITLE, ANY EPIDEMIC FAILURE WARRANTY AND ANY IMPLIED WARRANTIES OF MERCHANTABILITY, FITNESS FOR A PARTICULAR PURPOSE, AND NON-INFRINGEMENT OF ANY THIRD PARTY INTELLECTUAL PROPERTY RIGHTS. TI SHALL NOT BE LIABLE FOR AND SHALL NOT DEFEND OR INDEMNIFY DESIGNER AGAINST ANY CLAIM, INCLUDING BUT NOT LIMITED TO ANY INFRINGEMENT CLAIM THAT RELATES TO OR IS BASED ON ANY COMBINATION OF PRODUCTS EVEN IF DESCRIBED IN TI RESOURCES OR OTHERWISE. IN NO EVENT SHALL TI BE LIABLE FOR ANY ACTUAL, DIRECT, SPECIAL, COLLATERAL, INDIRECT, PUNITIVE, INCIDENTAL, CONSEQUENTIAL OR EXEMPLARY DAMAGES IN CONNECTION WITH OR ARISING OUT OF TI RESOURCES OR USE THEREOF, AND REGARDLESS OF WHETHER TI HAS BEEN ADVISED OF THE POSSIBILITY OF SUCH DAMAGES.

Unless TI has explicitly designated an individual product as meeting the requirements of a particular industry standard (e.g., ISO/TS 16949 and ISO 26262), TI is not responsible for any failure to meet such industry standard requirements.

Where TI specifically promotes products as facilitating functional safety or as compliant with industry functional safety standards, such products are intended to help enable customers to design and create their own applications that meet applicable functional safety standards and requirements. Using products in an application does not by itself establish any safety features in the application. Designers must ensure compliance with safety-related requirements and standards applicable to their applications. Designer may not use any TI products in life-critical medical equipment unless authorized officers of the parties have executed a special contract specifically governing such use. Life-critical medical equipment is medical equipment where failure of such equipment would cause serious bodily injury or death (e.g., life support, pacemakers, defibrillators, heart pumps, neurostimulators, and implantables). Such equipment includes, without limitation, all medical devices identified by the U.S. Food and Drug Administration as Class III devices and equivalent classifications outside the U.S.

TI may expressly designate certain products as completing a particular qualification (e.g., Q100, Military Grade, or Enhanced Product). Designers agree that it has the necessary expertise to select the product with the appropriate qualification designation for their applications and that proper product selection is at Designers' own risk. Designers are solely responsible for compliance with all legal and regulatory requirements in connection with such selection.

Designer will fully indemnify TI and its representatives against any damages, costs, losses, and/or liabilities arising out of Designer's non-compliance with the terms and provisions of this Notice.

Looking for pricing, stock, or lifecycle information?

Click below to explore more details on WIN SOURCE:

 [View LMH2180SDE/NOPB on WIN SOURCE](#)

 [Texas Instruments](#) Information

Optimize Your Supply Chain with WIN SOURCE Solutions

-  Global Sourcing Solution
-  Obsolete Management
-  Cost Control Management
-  Shortage Management
-  Alternative Solution
-  Excess Inventory Management