



**THE DATASHEET OF
LMH2120UMX/NOPB**



LMH2120 6 GHz Linear RMS Power Detector with 40 dB Dynamic Range

Check for Samples: [LMH2120](#)

FEATURES

- Linear Root Mean Square Response
- 40 dB Linear-in-V Power Detection Range
- Multi-Band Operation from 50 MHz to 6 GHz
- Lin Conformance Better than ± 0.5 dB
- Highly Temperature Insensitive
- Modulation Independent Response
- Minimal Slope and Intercept Variation
- Shutdown Functionality
- Wide Supply Range from 2.7V to 5V
- Tiny 6-Bump DSBGA Package

APPLICATIONS

- Multi Mode, Multi Band RF Power Control
 - GSM/EDGE
 - CDMA/CDMA2000
 - W-CDMA
 - OFDMA
 - LTE
- Infrastructure RF Power Control

DESCRIPTION

The LMH2120 is a 40 dB Linear RMS power detector particularly suited for accurate power measurement of modulated RF signals that exhibit large peak-to-average ratios, i.e, large variations of the signal envelope. Such signals are encountered in W-CDMA and LTE cell phones. The RMS measurement topology inherently ensures a modulation insensitive measurement.

The device has an RF frequency range from 50 MHz to 6 GHz. It provides an accurate, temperature and supply insensitive, output voltage that relates linearly to the RF input power in volt. The LMH2120's excellent conformance to a linear response enables an easy integration by using slope and intercept only, reducing calibration effort significantly. The device operates with a single supply from 2.7V to 5V. The LMH2120 has an RF power detection range from -35 dBm to 5 dBm and is ideally suited for use in combination with a directional coupler. Alternatively, a resistive divider can be used.

The device is active for EN = High, otherwise it is in a low power consumption shutdown mode. To save power and prevent discharge of an external filter capacitance, the output (OUT) is high impedance during shutdown.

The LMH2120 power detector is offered in a tiny 6-bump DSBGA package.

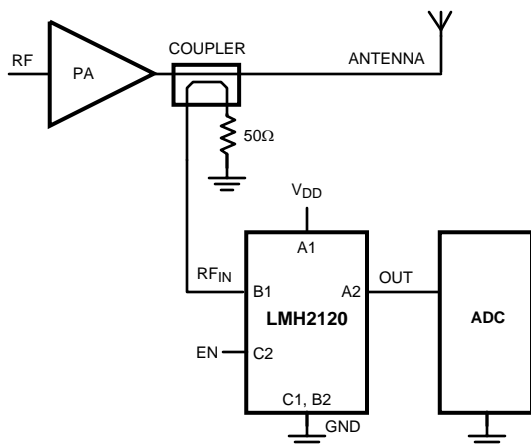
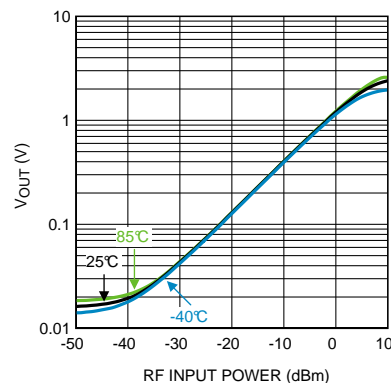
Figure 1. Typical Application

Figure 2. Output Voltage vs. RF Input Power at 1900 MHz

Please be aware that an important notice concerning availability, standard warranty, and use in critical applications of Texas Instruments semiconductor products and disclaimers thereto appears at the end of this data sheet.

All trademarks are the property of their respective owners.



These devices have limited built-in ESD protection. The leads should be shorted together or the device placed in conductive foam during storage or handling to prevent electrostatic damage to the MOS gates.

Absolute Maximum Ratings ⁽¹⁾⁽²⁾

Supply Voltage	
$V_{DD} - GND$	5.5V
RF Input	
Input power	12 dBm
DC Voltage	1V
Enable (EN) Input Voltage	$GND - 0.4V < V_{EN}$ and $V_{EN} < \text{Min}(V_{DD} + 0.4, 3.6V)$
ESD Tolerance ⁽³⁾	
Human Body Model	2000V
Machine Model	200V
Charge Device Model	1000V
Storage Temperature Range	-65°C to 150°C
Junction Temperature ⁽⁴⁾	150°C
For soldering specifications: See product folder at www.ti.com and SNOA549	

- (1) Absolute Maximum Ratings indicate limits beyond which damage to the device may occur. Operating Ratings indicate conditions for which the device is intended to be functional, but specific performance is not ensured. For ensured specifications and the test conditions, see the Electrical Characteristics.
- (2) If Military/Aerospace specified devices are required, please contact the Texas Instruments Sales Office/ Distributors for availability and specifications.
- (3) Human body model, applicable std. MIL-STD-883, Method 3015.7. Machine model, applicable std. JESD22–A115–A (ESD MM std of JEDEC). Field-Induced Charge-Device Model, applicable std. JESD22–C101–C. (ESD FICDM std. of JEDEC)
- (4) The maximum power dissipation is a function of $T_{J(\text{MAX})}$, θ_{JA} . The maximum allowable power dissipation at any ambient temperature is $P_D = (T_{J(\text{MAX})} - T_A)/\theta_{JA}$. All numbers apply for packages soldered directly into a PC board.

Operating Ratings ⁽¹⁾

Supply Voltage	2.7V to 5V
Temperature Range	-40°C to +85°C
RF Frequency Range	50 MHz to 6 GHz
RF Input Power Range	-35 dBm to 5 dBm
Package Thermal Resistance θ_{JA} ⁽²⁾	166.7°C/W

- (1) Absolute Maximum Ratings indicate limits beyond which damage to the device may occur. Operating Ratings indicate conditions for which the device is intended to be functional, but specific performance is not ensured. For ensured specifications and the test conditions, see the Electrical Characteristics.
- (2) The maximum power dissipation is a function of $T_{J(\text{MAX})}$, θ_{JA} . The maximum allowable power dissipation at any ambient temperature is $P_D = (T_{J(\text{MAX})} - T_A)/\theta_{JA}$. All numbers apply for packages soldered directly into a PC board.

2.7 V and 4.5V DC and AC Electrical Characteristics

Unless otherwise specified, all limits are ensured to $T_A = 25^\circ\text{C}$, $V_{DD} = 2.7\text{V}$ and 4.5V (worst case of the 2 is specified), $\text{RF}_{IN} = 1900\text{ MHz CW}$ (Continuous Wave, unmodulated). **Boldface** limits apply at the temperature extremes ⁽¹⁾.

Symbol	Parameter	Condition	Min (2)	Typ (3)	Max (2)	Units	
Supply Interface							
I_{DD}	Supply Current	Active mode: EN = High, no signal present at RF_{IN} .		2.9	3.5 4.0	mA	
		Shutdown: EN = LOW, no signal present at RF_{IN}	$V_{BAT} = 2.7\text{V}$		3.8	4.7 5.0	μA
			$V_{BAT} = 4.5\text{V}$		4.7	5.7 6.1	
		EN = LOW, $\text{RF}_{IN} = 0\text{ dBm}$, 1900 MHz	$V_{BAT} = 2.7\text{V}$		3.8	4.7 5.0	μA
$V_{BAT} = 4.5\text{V}$			4.7	5.7 6.1			
PSRR	Power Supply Rejection Ratio	$\text{RF}_{IN} = -10\text{ dBm}$, 1900 MHz, $2.7\text{V} < V_{BAT} < 5\text{V}$	50	60		dB	
Logic Enable Interface							
V_{LOW}	EN logic LOW input level (Shutdown mode)				0.6	V	
V_{HIGH}	EN logic HIGH input level		1.1				
I_{EN}	Current into EN pin				50	nA	
Input / Output Interface							
R_{IN}	Input Resistance		44	50	56	Ω	
V_{OUT}	Minimum Output Voltage (Pedestal)	No Input Signal		18	29 33	mV	
R_{OUT}	Output Resistance	EN = HIGH, $\text{RF}_{IN} = -10\text{ dBm}$, 1900 MHz, $I_{LOAD} = 1\text{ mA}$, DC measurement		1	2 3	Ω	
I_{OUT}	Output Sinking Current	$\text{RF}_{IN} = -10\text{ dBm}$, 1900 MHz, OUT connected to 2.5V	30 25	42		mA	
	Output Sourcing Current	$\text{RF}_{IN} = -10\text{ dBm}$, 1900 MHz, OUT connected to GND	36 31	45			
$I_{OUT, SD}$	Output Leakage Current in Shutdown Mode	EN = LOW, OUT connected to 2V			80	nA	
e_n	Output Referred Noise ⁽⁴⁾	$\text{RF}_{IN} = -10\text{ dBm}$, 1900 MHz, output spectrum at 10 kHz		5		$\mu\text{V}/\sqrt{\text{Hz}}$	
v_n	Output Referred Noise Integrated ⁽⁴⁾	Integrated over frequency band 1 kHz - 6.5 kHz, $\text{RF}_{IN} = -10\text{ dBm}$, 1900 MHz		390		μV_{RMS}	
Timing Characteristics							
t_{ON}	Turn-on Time from shutdown	$\text{RF}_{IN} = -10\text{ dBm}$, 1900 MHz, EN LOW-to-HIGH transition to OUT at 90%		13	18	μs	
t_R	Rise Time	Signal at RF_{IN} from -20 dBm to 0 dBm, 10% to 90%, 1900 MHz		7		μs	
t_F	Fall Time	Signal at RF_{IN} from 0 dBm to -20 dBm, 90% to 10%, 1900 MHz		18		μs	

- (1) Electrical Table values apply only for factory testing conditions at the temperature indicated. Factory testing conditions result in very limited self-heating of the device such that $T_J = T_A$. No specification of parametric performance is indicated in the electrical tables under conditions of internal self-heating where $T_J > T_A$.
- (2) All limits are ensured by test or statistical analysis.
- (3) Typical values represent the most likely parametric norm as determined at the time of characterization. Actual typical values may vary over time and will also depend on the application and configuration. The typical values are not tested and are not specified on shipped production material.
- (4) This parameter is ensured by design and/or characterization and is not tested in production.

2.7 V and 4.5V DC and AC Electrical Characteristics (continued)

Unless otherwise specified, all limits are ensured to $T_A = 25^\circ\text{C}$, $V_{DD} = 2.7\text{V}$ and 4.5V (worst case of the 2 is specified), $\text{RF}_{IN} = 1900\text{ MHz CW}$ (Continuous Wave, unmodulated). **Boldface** limits apply at the temperature extremes ⁽¹⁾.

Symbol	Parameter	Condition	Min (2)	Typ (3)	Max (2)	Units
RF Detector Transfer , fit range -15 dBm to -5 dBm for Linear Slope and Intercept $\text{RF}_{IN} = 50\text{ MHz}$ ⁽⁵⁾						
P_{MIN}	Minimum Power Level, bottom end of Dynamic Range	Log Conformance Error within $\pm 1\text{ dB}$		-37		dBm
P_{MAX}	Maximum Power Level, top end of Dynamic Range			4		
V_{MIN}	Minimum Output Voltage	At P_{MIN}		31		mV
V_{MAX}	Maximum Output Voltage	At P_{MAX}		2.6		V
K_{SLOPE}	Linear Slope			1		dB/dB
P_{INT}	Linear Intercept	$V_{OUT} = 0\text{ dBV}$	-5.7	-5.5	-5.3	dBm
DR	Dynamic Range for specified Accuracy	$\pm 1\text{ dB}$ Lin Conformance Error (E_{LC})	37 36	41 40		dB
		$\pm 3\text{ dB}$ Lin Conformance Error (E_{LC})	44 43	48 47		
		$\pm 0.5\text{ dB}$ Variation over Temperature (E_{VOT})	41	45		
$\text{RF}_{IN} = 900\text{ MHz}$ ⁽⁵⁾						
P_{MIN}	Minimum Power Level, bottom end of Dynamic Range	Lin Conformance Error within $\pm 1\text{ dB}$		-35		dBm
P_{MAX}	Maximum Power Level, top end of Dynamic Range			5		
V_{MIN}	Minimum Output Voltage	At P_{MIN}		33		mV
V_{MAX}	Maximum Output Voltage	At P_{MAX}		2.5		V
K_{SLOPE}	Linear Slope			1		dB/dB
P_{INT}	Linear Intercept	$V_{OUT} = 0\text{ dBV}$	-4.2	-4.0	-3.8	dBm
DR	Dynamic Range for specified Accuracy	$\pm 1\text{ dB}$ Lin Conformance Error (E_{LC})	36 33	40 37		dB
		$\pm 3\text{ dB}$ Lin Conformance Error (E_{LC})	45 44	48 47		
		$\pm 0.5\text{ dB}$ Variation over Temperature (E_{VOT})	41	44		
		$\pm 0.3\text{ dB}$ Error for a 1dB Power Step (E_{1dB})		41 40		
		$\pm 1\text{ dB}$ Error for a 10dB Power Step (E_{10dB})		45		
E_{MOD}	Input referred Variation due to Modulation	W-CDMA Release 6/7/8, -35 dBm < RF_{IN} < -3 dBm		0.15		dB
		LTE, -35 dBm < RF_{IN} < -3 dBm		0.29		
$\text{RF}_{IN} = 1900\text{ MHz}$ ⁽⁵⁾						
P_{MIN}	Minimum Power Level, bottom end of Dynamic Range	Lin Conformance Error within $\pm 1\text{ dB}$		-34		dBm
P_{MAX}	Maximum Power Level, top end of Dynamic Range			4		
V_{MIN}	Minimum Output Voltage	At P_{MIN}		30		mV
V_{MAX}	Maximum Output Voltage	At P_{MAX}		1.7		V
K_{SLOPE}	Linear Slope			1		dB/dB
P_{INT}	Linear Intercept	$V_{OUT} = 0\text{ dBV}$	-2.2	-1.8	-1.4	dBm

(5) Limits are ensured by design and measurements which are performed on a limited number of samples.

2.7 V and 4.5V DC and AC Electrical Characteristics (continued)

Unless otherwise specified, all limits are ensured to $T_A = 25^\circ\text{C}$, $V_{DD} = 2.7\text{V}$ and 4.5V (worst case of the 2 is specified), $\text{RF}_{IN} = 1900\text{ MHz CW}$ (Continuous Wave, unmodulated). **Boldface** limits apply at the temperature extremes ⁽¹⁾.

Symbol	Parameter	Condition	Min (2)	Typ (3)	Max (2)	Units
DR	Dynamic Range for specified Accuracy	$\pm 1\text{ dB}$ Lin Conformance Error (E_{LC})	35 31	38 35		dB
		$\pm 3\text{ dB}$ Lin Conformance Error (E_{LC})	44 41	48 45		
		$\pm 0.5\text{ dB}$ Variation over Temperature (E_{VOT})	35	40		
		$\pm 0.3\text{ dB}$ Error for a 1dB Power Step (E_{1dB})		39 36		
		$\pm 1\text{ dB}$ Error for a 10dB Power Step (E_{10dB})		35		
E_{MOD}	Input referred Variation due to Modulation	W-CDMA Release 6/7/8, $-34\text{ dBm} < \text{RF}_{IN} < -2\text{ dBm}$		0.16		dB
		LTE, $-34\text{ dBm} < \text{RF}_{IN} < -2\text{ dBm}$		0.24		
$\text{RF}_{IN} = 2600\text{ MHz}$ ⁽⁵⁾						
P_{MIN}	Minimum Power Level, bottom end of Dynamic Range	Lin Conformance Error within $\pm 1\text{ dB}$		-30		dBm
P_{MAX}	Maximum Power Level, top end of Dynamic Range			6		
V_{MIN}	Minimum Output Voltage	At P_{MIN}		31		mV
V_{MAX}	Maximum Output Voltage	At P_{MAX}		1.5		V
K_{SLOPE}	Linear Slope			1		dB/dB
P_{INT}	Linear Intercept	$V_{OUT} = 0\text{ dBV}$	0.8	1.7	2.6	dBm
DR	Dynamic Range for specified Accuracy	$\pm 1\text{ dB}$ Lin Conformance Error (E_{LC})	32 29	36 33		dB
		$\pm 3\text{ dB}$ Lin Conformance Error (E_{LC})	43 40	45 42		
		$\pm 0.5\text{ dB}$ Variation over Temperature (E_{VOT})	34	39		
$\text{RF}_{IN} = 3500\text{ MHz}$ ⁽⁶⁾						
P_{MIN}	Minimum Power Level, bottom end of Dynamic Range	Lin Conformance Error within $\pm 1\text{ dB}$		-26		dBm
P_{MAX}	Maximum Power Level, top end of Dynamic Range			7		
V_{MIN}	Minimum Output Voltage	At P_{MIN}		32		mV
V_{MAX}	Maximum Output Voltage	At P_{MAX}		1.1		V
K_{SLOPE}	Linear Slope			1		dB/dB
P_{INT}	Linear Intercept	$V_{OUT} = 0\text{ dBV}$	4.4	5.5	6.7	dBm
DR	Dynamic Range for specified Accuracy	$\pm 1\text{ dB}$ Lin Conformance Error (E_{LC})	30 27	33 30		dB
		$\pm 3\text{ dB}$ Lin Conformance Error (E_{LC})	39 36	42 40		
		$\pm 0.5\text{ dB}$ Variation over Temperature (E_{VOT})	27	35		

(6) Limits are ensured by design and measurements which are performed on a limited number of samples.

CONNECTION DIAGRAM

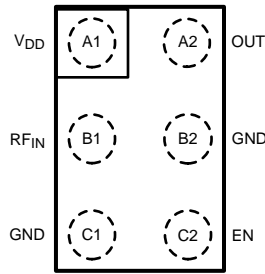

Figure 3. 6-Bump DSBGA Top View

PIN DESCRIPTIONS

	DSBGA	Name	Description
Power Supply	A1	V _{DD}	Positive Supply Voltage.
	C1	GND	Ground. Both C1 and B2 need to be connected to GND.
	B2		
Logic Input	C2	EN	The device is enabled for EN = High, and in shutdown mode for EN = LOW. EN should be <2.5V when I _{EN} is LOW. For EN >2.5V, I _{EN} increases slightly while the device is still functional. Absolute maximum rating for EN = 3.6V.
Analog Input	B1	RF _{IN}	RF input signal to the detector, internally terminated with 50 Ω.
Output	A2	OUT	Ground referenced detector output voltage.

BLOCK DIAGRAM

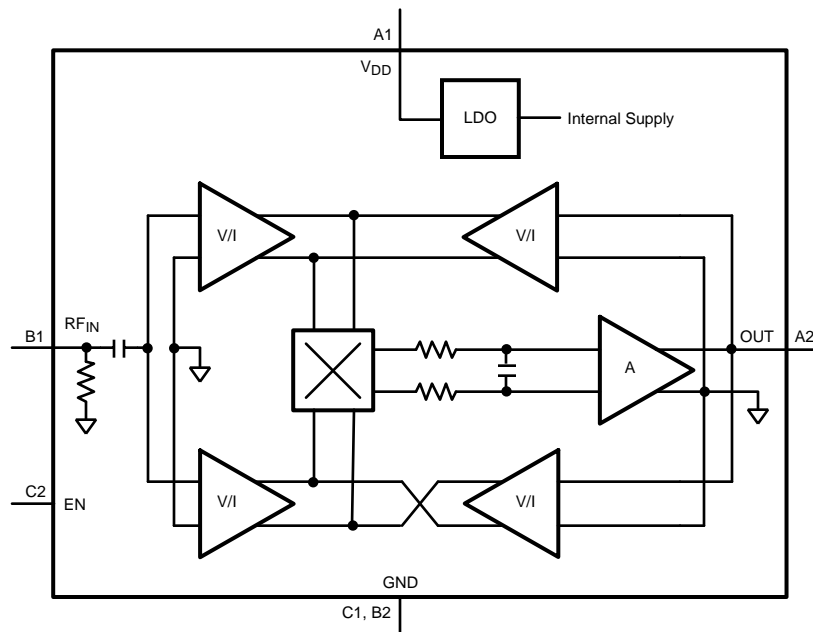

Figure 4. LMH2120

Typical Performance Characteristics

Unless otherwise specified $T_A = 25^\circ\text{C}$, $V_{\text{BAT}} = 2.7\text{V}$, $\text{RF}_{\text{IN}} = 1900\text{ MHz CW}$ (Continuous Wave, unmodulated). Specified errors are input referred.

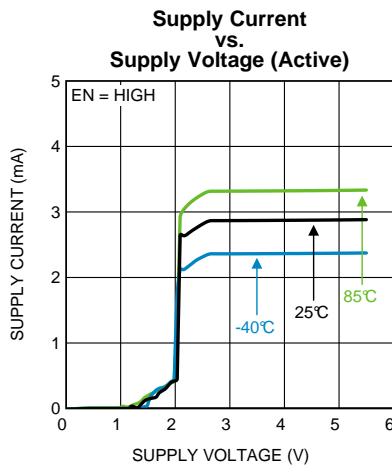

Figure 5.

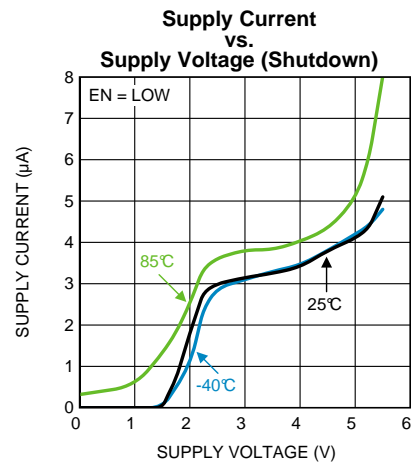

Figure 6.

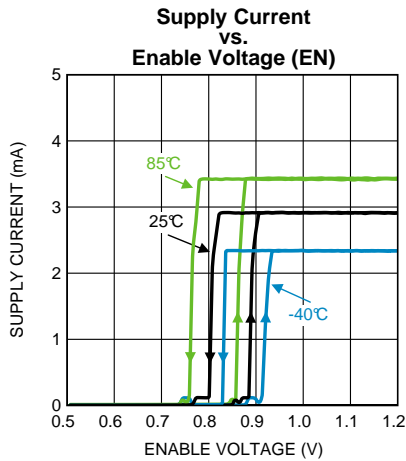

Figure 7.

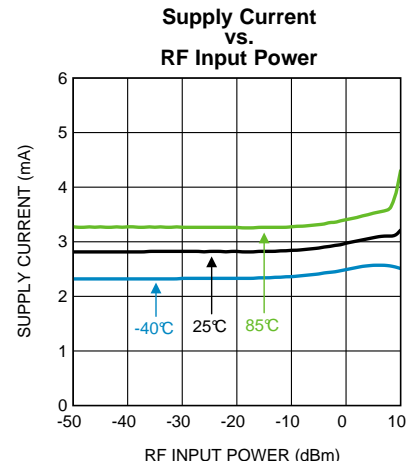

Figure 8.

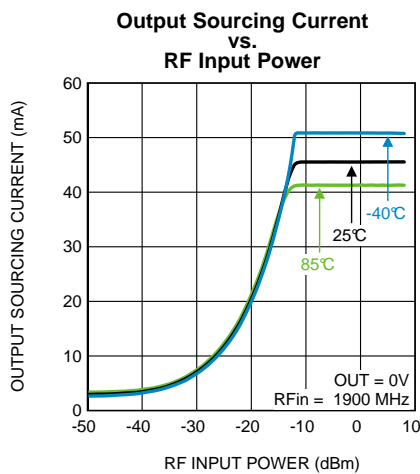

Figure 9.

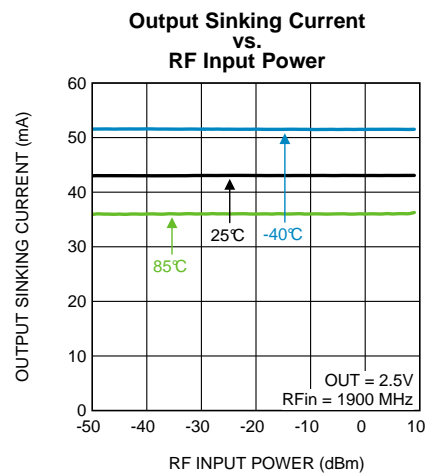

Figure 10.

Typical Performance Characteristics (continued)

Unless otherwise specified $T_A = 25^\circ\text{C}$, $V_{BAT} = 2.7\text{V}$, $R_{FIN} = 1900\text{ MHz CW}$ (Continuous Wave, unmodulated). Specified errors are input referred.

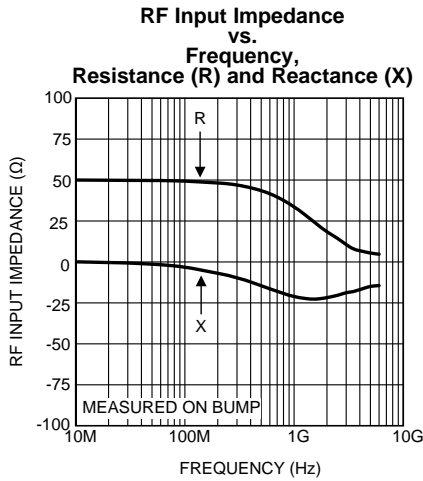

Figure 11.

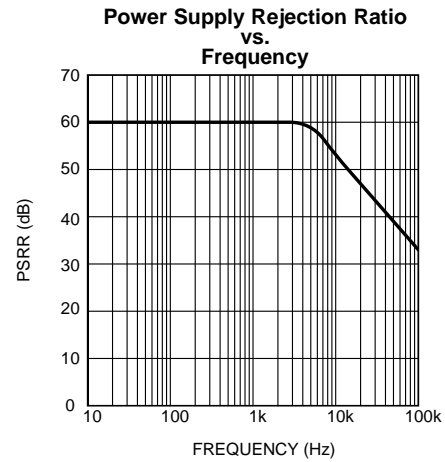

Figure 12.

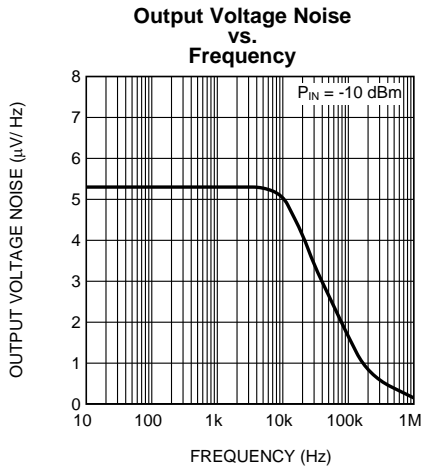

Figure 13.

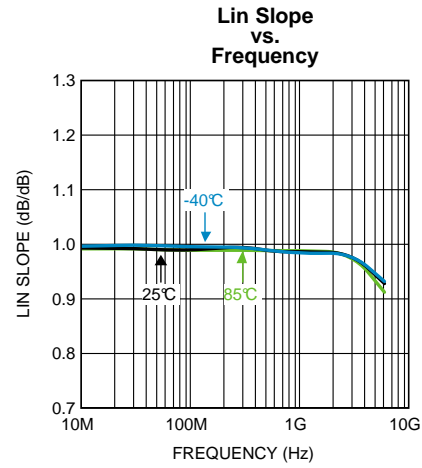

Figure 14.

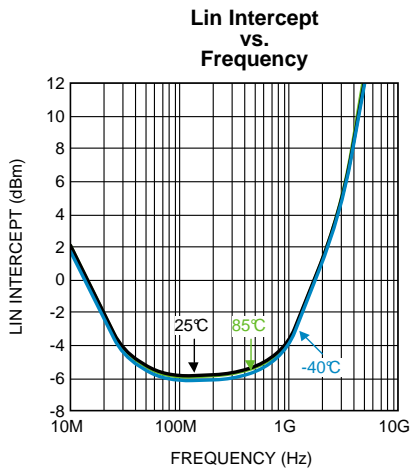

Figure 15.

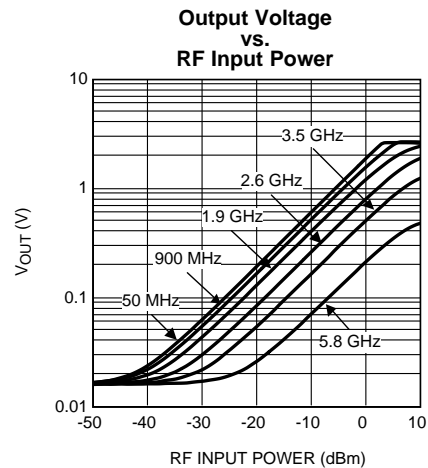

Figure 16.

Typical Performance Characteristics (continued)

Unless otherwise specified $T_A = 25^\circ\text{C}$, $V_{\text{BAT}} = 2.7\text{V}$, $\text{RF}_{\text{IN}} = 1900\text{ MHz CW}$ (Continuous Wave, unmodulated). Specified errors are input referred.

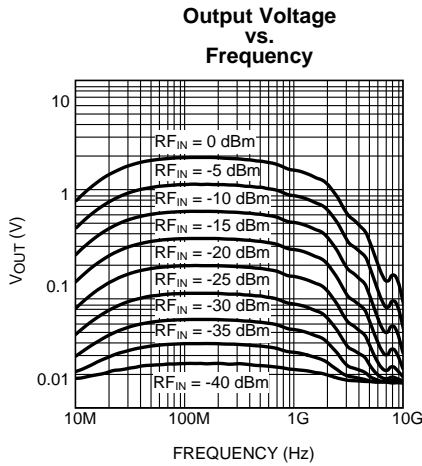

Figure 17.

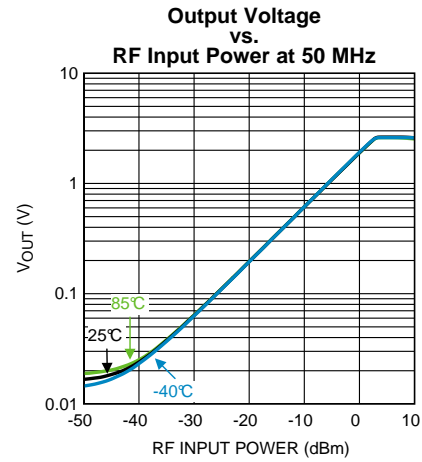

Figure 18.

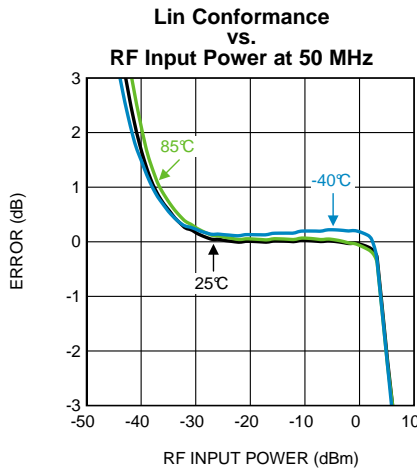

Figure 19.

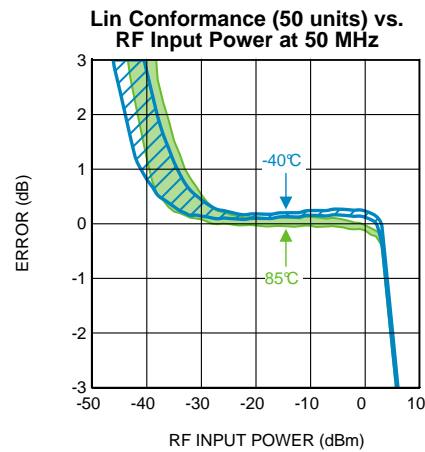

Figure 20.

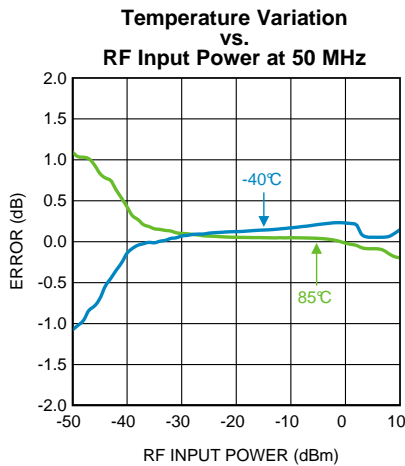

Figure 21.

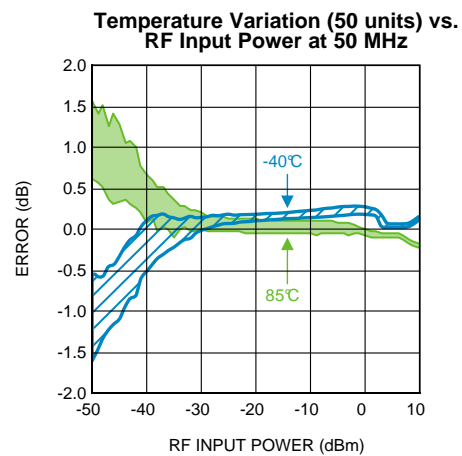

Figure 22.

Typical Performance Characteristics (continued)

Unless otherwise specified $T_A = 25^\circ\text{C}$, $V_{BAT} = 2.7\text{V}$, $R_{F\text{IN}} = 1900\text{ MHz CW}$ (Continuous Wave, unmodulated). Specified errors are input referred.

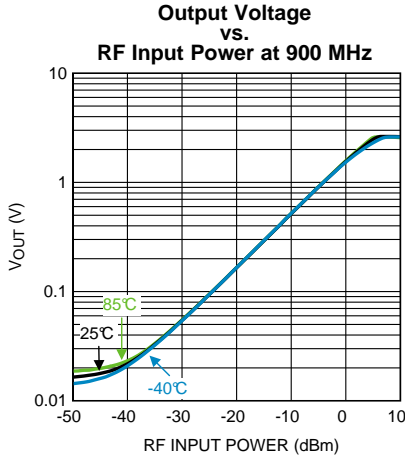

Figure 23.

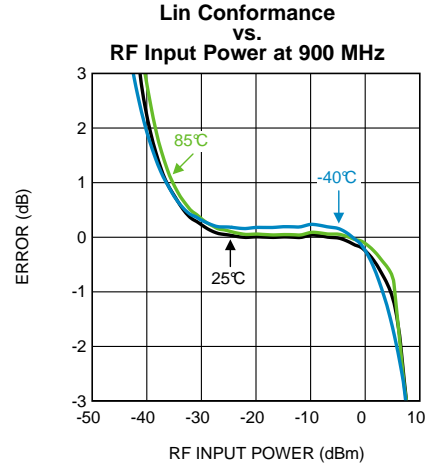

Figure 24.

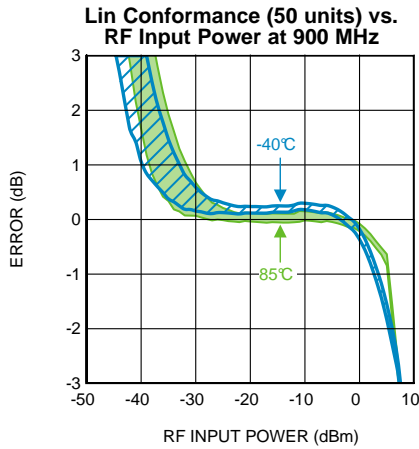

Figure 25.

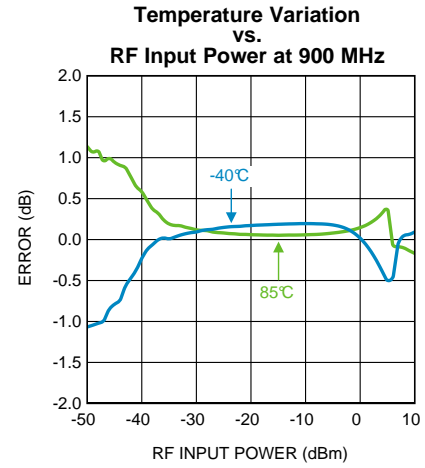

Figure 26.

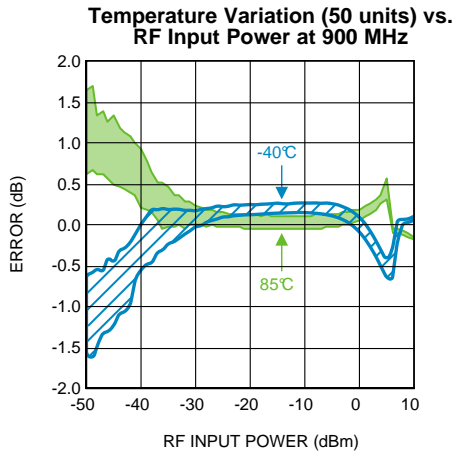

Figure 27.

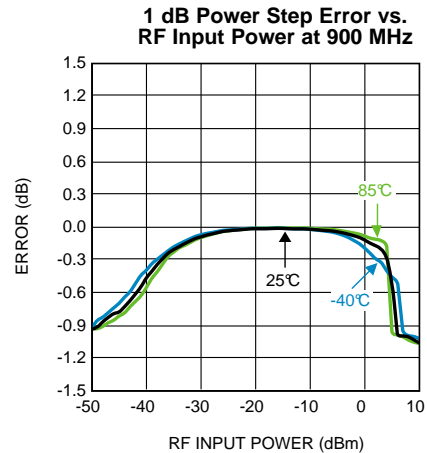

Figure 28.

Typical Performance Characteristics (continued)

Unless otherwise specified $T_A = 25^\circ\text{C}$, $V_{\text{BAT}} = 2.7\text{V}$, $R_{\text{FIN}} = 1900\text{ MHz CW}$ (Continuous Wave, unmodulated). Specified errors are input referred.

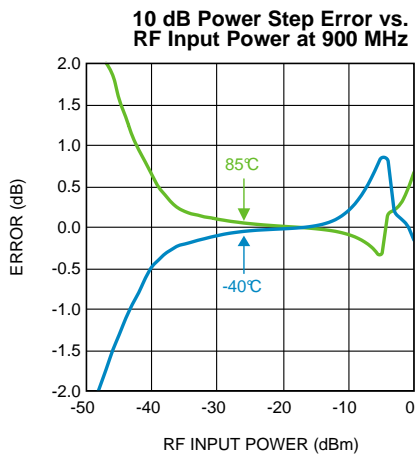

Figure 29.

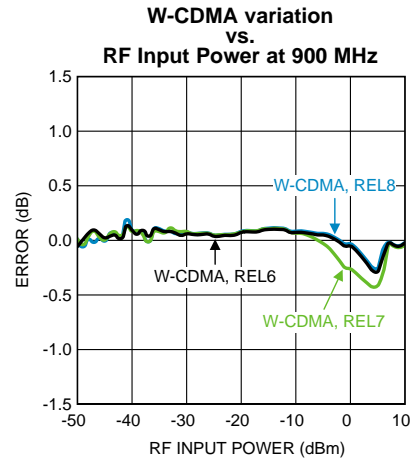

Figure 30.

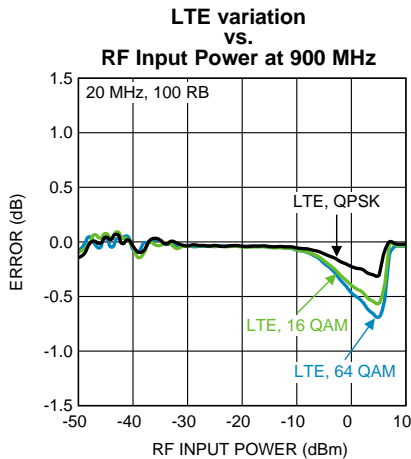

Figure 31.

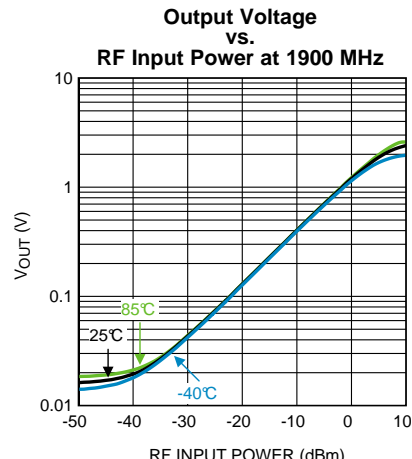

Figure 32.

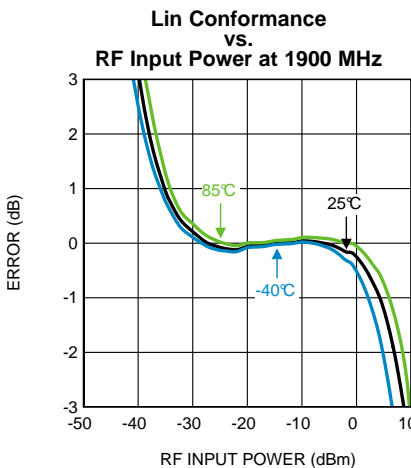

Figure 33.

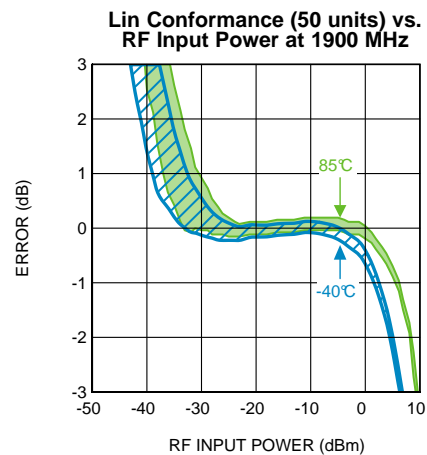

Figure 34.

Typical Performance Characteristics (continued)

Unless otherwise specified $T_A = 25^\circ\text{C}$, $V_{BAT} = 2.7\text{V}$, $R_{F\text{IN}} = 1900\text{ MHz CW}$ (Continuous Wave, unmodulated). Specified errors are input referred.

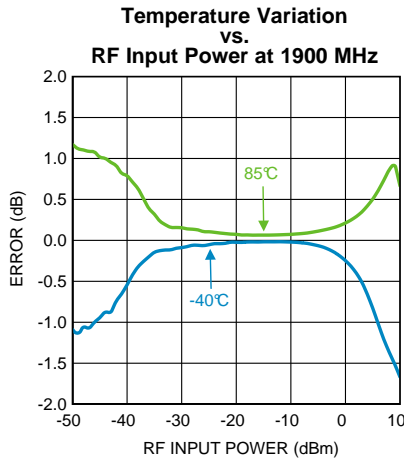

Figure 35.

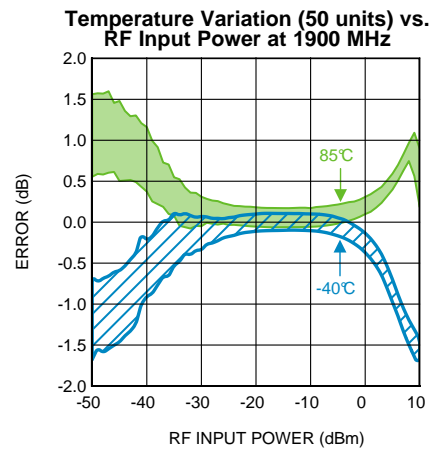

Figure 36.

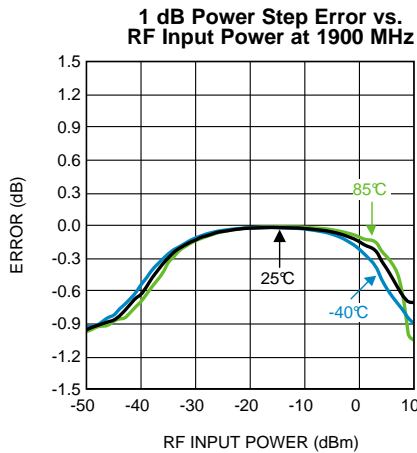

Figure 37.

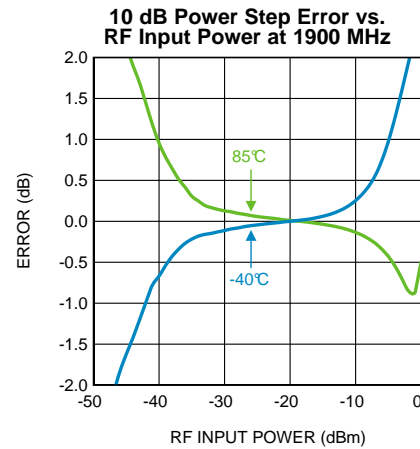

Figure 38.

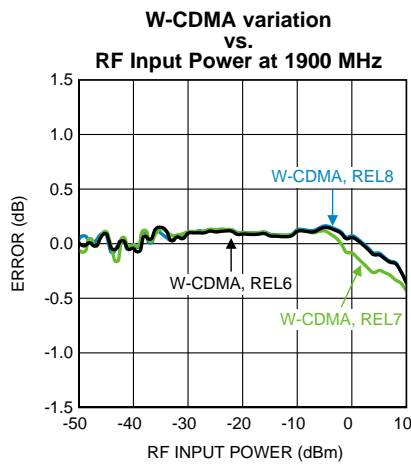

Figure 39.

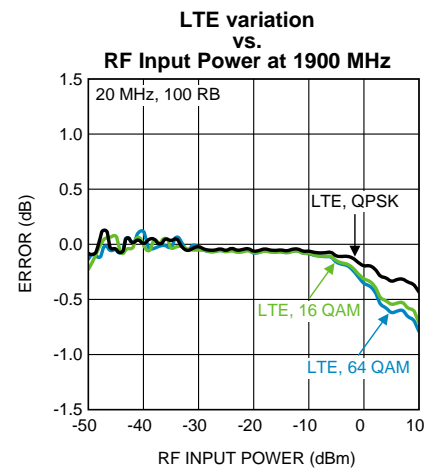

Figure 40.

Typical Performance Characteristics (continued)

Unless otherwise specified $T_A = 25^\circ\text{C}$, $V_{\text{BAT}} = 2.7\text{V}$, $R_{\text{FIN}} = 1900\text{ MHz CW}$ (Continuous Wave, unmodulated). Specified errors are input referred.

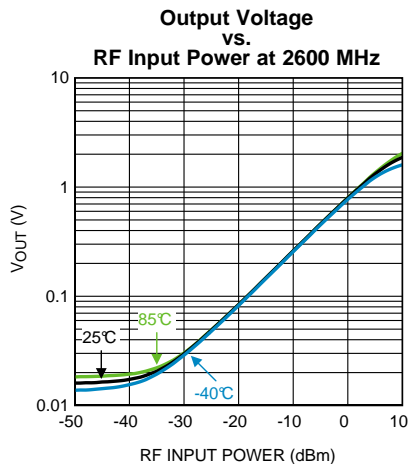

Figure 41.

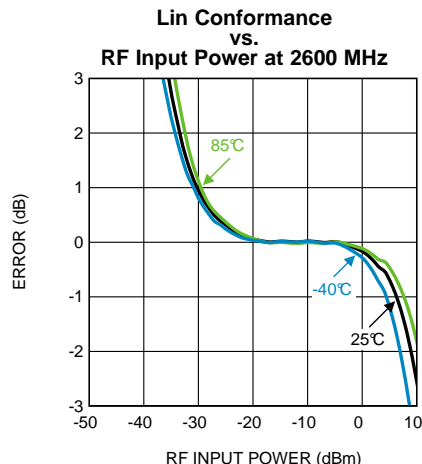

Figure 42.

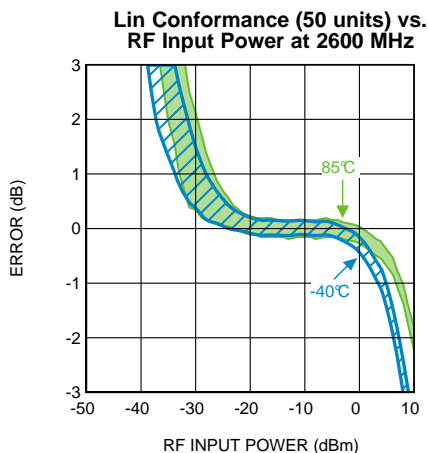

Figure 43.

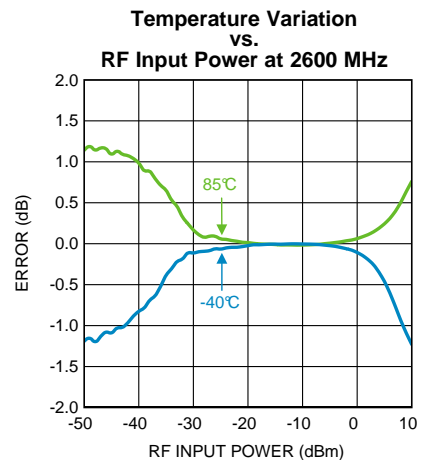

Figure 44.

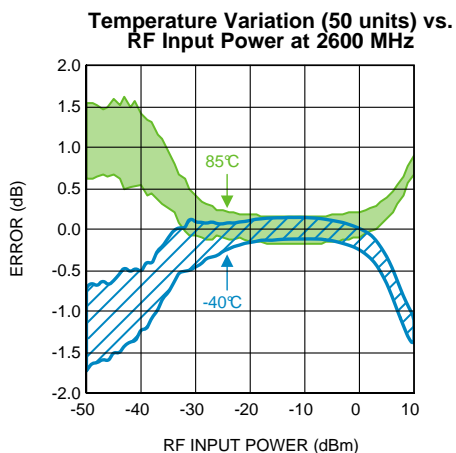

Figure 45.

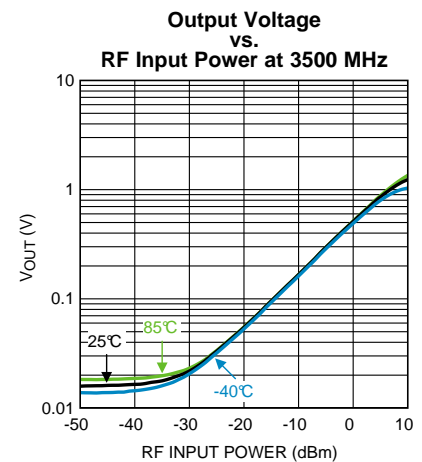

Figure 46.

Typical Performance Characteristics (continued)

Unless otherwise specified $T_A = 25^\circ\text{C}$, $V_{BAT} = 2.7\text{V}$, $R_{F\text{IN}} = 1900\text{ MHz CW}$ (Continuous Wave, unmodulated). Specified errors are input referred.

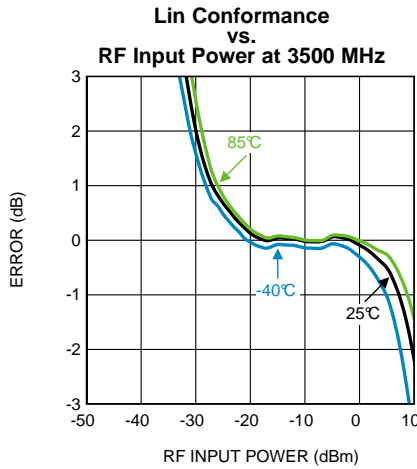

Figure 47.

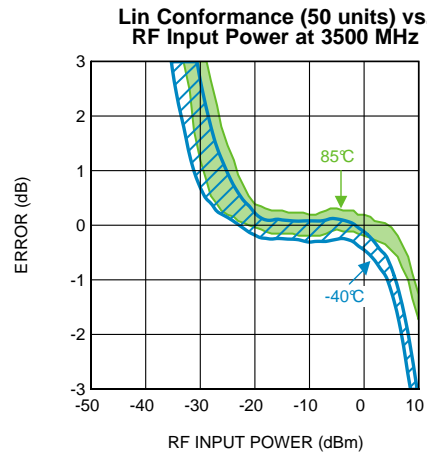

Figure 48.

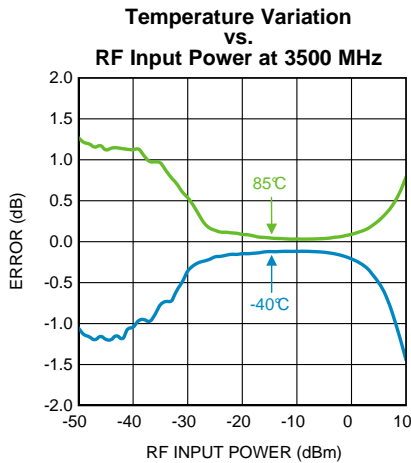

Figure 49.

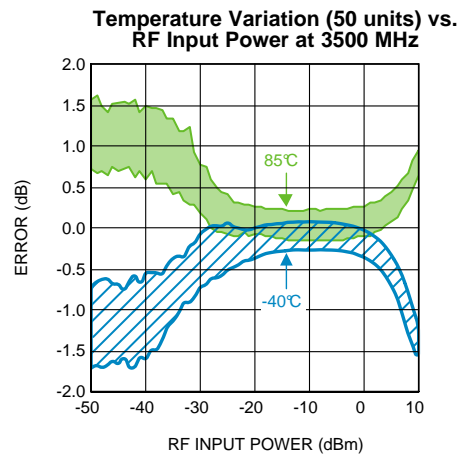

Figure 50.

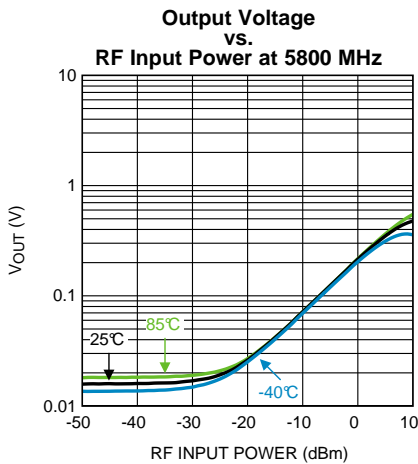

Figure 51.

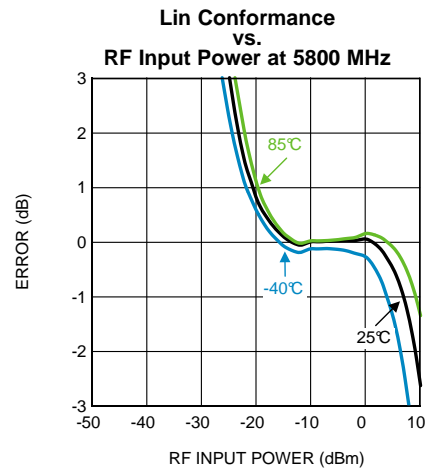
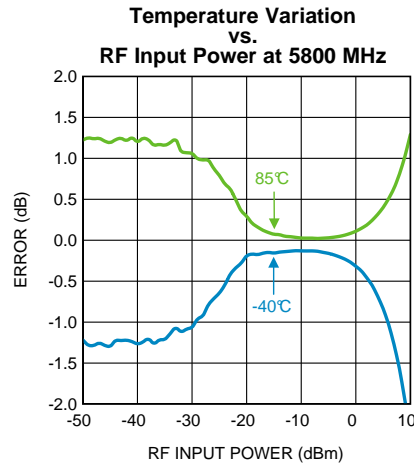

Figure 52.

Typical Performance Characteristics (continued)

Unless otherwise specified $T_A = 25^\circ\text{C}$, $V_{\text{BAT}} = 2.7\text{V}$, $R_{\text{FIN}} = 1900\text{ MHz CW}$ (Continuous Wave, unmodulated). Specified errors are input referred.



APPLICATION INFORMATION

The LMH2120 is a 40 dB Linear RMS power detector particularly suited for accurate power measurements of modulated RF signals that exhibit large peak-to-average ratios (PAR's). The RMS detector implements the exact definition of power resulting in a power measurement insensitive to high PAR's. Such signals are encountered, e.g. in LTE and W-CDMA applications. The LMH2120 has an RF frequency range from 50 MHz to 6 GHz. It provides an output voltage that relates linearly to the RF input power in volt. Its output voltage is highly insensitive to temperature and supply variations.

TYPICAL APPLICATION

The LMH2120 can be used in a wide variety of applications like LTE, W-CDMA, CDMA and GSM. This section discusses the LMH2120 in a typical transmit power control loop for such applications.

Transmit-power-control-loop circuits make the transmit-power level insensitive to power amplifier (PA) inaccuracy. This is desirable because power amplifiers are non-linear devices and temperature dependent, making it hard to estimate the exact transmit power level. If a control loop is used, the inaccuracy of the PA is eliminated from the overall accuracy of the transmit power level. The accuracy of the transmit power level now depends on the RF detector accuracy instead. The LMH2120 is especially suited for transmit-power control applications, since it accurately measures transmit power and is insensitive to temperature, supply voltage and modulation variations.

Figure 54 shows a simplified schematic of a typical transmit-power control system. The output power of the PA is measured by the LMH2120 through a directional coupler. The measured output voltage of the LMH2120 is digitized by the ADC inside the baseband chip. Accordingly, the baseband controls the PA output power level by changing the gain control signal of the RF VGA. Although the output ripple of the LMH2120 is typically low enough, an optional low-pass filter can be placed in between the LMH2120 and the ADC to further reduce the ripple.

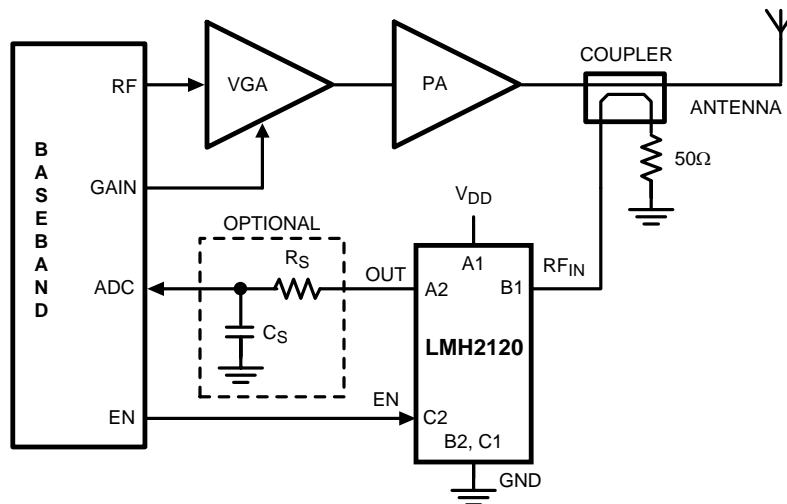

Figure 54. Transmit-Power Control System

ACCURATE POWER MEASUREMENT

Detectors have evolved over the years along with the communication standards. Newer communication standards like LTE and W-CDMA raise the need for more advanced accurate power detectors. To be able to distinguish the various detector types it is important to understand what the ideal power measurement should look like and how a power measurement is implemented.

Power is a metric for the average energy content of a signal. By definition it is not a function of the signal shape over time. In other words, the power content of a 0 dBm sine wave is identical to the power content of a 0 dBm square wave or a 0 dBm W-CDMA signal; all these signals have the same average power content.

The average power can be described by the following formula:

$$P = \frac{1}{T} \int_0^T \frac{v(t)^2}{R} dt = \frac{V_{RMS}^2}{R} \quad (1)$$

where T is the time interval over which is averaged, v(t) is the instantaneous voltage at time t, R is the resistance in which the power is dissipated, and V_{RMS} is the equivalent RMS voltage.

According to aforementioned formula for power, an exact power measurement can be done by measuring the RMS voltage (V_{RMS}) of a signal. The RMS voltage is described by:

$$V_{RMS} = \sqrt{\frac{1}{T} \int v(t)^2 dt} \quad (2)$$

Implementing the exact formula for RMS can be difficult however. A simplification can be made in determining the average power when information about the waveform is available. If the signal shape is known, the relationship between RMS value and, for instance, the peak value of the RF signal is also known. It thus enables a measurement based on measuring peak voltage rather than measuring the RMS voltage. To calculate the RMS value (and therewith the average power), the measured peak voltage is translated into an RMS voltage based on the waveform characteristics. A few examples:

- Sine wave: $V_{RMS} = V_{PEAK} / \sqrt{2}$
- Square wave: $V_{RMS} = V_{PEAK}$
- Saw-tooth wave: $V_{RMS} = V_{PEAK} / \sqrt{3}$

For more complex waveforms it is not always easy to determine the exact relationship between RMS value and peak value. A peak measurement can therefore become impractical. An approximation can be used for the V_{RMS} to V_{PEAK} relationship, but it can result in a less accurate average power estimate.

Depending on the detection mechanism, power detectors may produce a slightly different output signal in response to the earlier mentioned waveforms, even though the average power level of these signals are the same. This error is due to the fact that not all power detectors strictly implement the definition for signal power, being the root mean square (RMS) of the signal. To cover for the systematic error in the output response of a detector, calibration can be used. After calibration a look-up table corrects for the error. Multiple look-up tables can be created for different modulation schemes.

TYPES OF RF DETECTORS

This section provides an overview of detectors based on their detection principle. Detectors that will be discussed are:

- [Peak Detectors](#)
- [LOG Amp Detectors](#)
- [RMS Detectors](#)

Peak Detectors

A peak detector is one of the simplest type of detector, storing the highest value arising in a certain time window. However, a peak detector is typically used with a relatively long holding time when compared to the carrier frequency and a relatively short holding time with respect to the envelope frequency. In this way a peak detector is used as AM demodulator or envelope tracker ([Figure 55](#)).

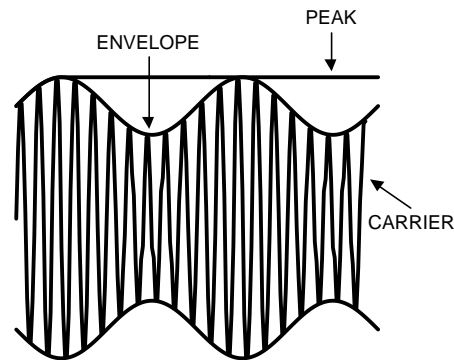

Figure 55. Peak Detection vs. Envelope Tracking

A peak detector usually has a linear response. An example of this is a diode detector (Figure 56). The diode rectifies the RF input voltage; subsequently, the RC filter determines the averaging (holding) time. The selection of the holding time configures the diode detector for its particular application. For envelope tracking, a relatively small RC time constant is chosen such that the output voltage tracks the envelope nicely. In contrast, a configuration with a relatively large time constant measures the maximum (peak) voltage of a signal.

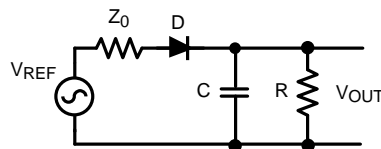

Figure 56. Diode Detector

Since peak detectors measure a peak voltage, their response is inherently dependent on the signal shape or modulation form as discussed in the previous section. Knowledge about the signal shape is required to determine an RMS value. For complex systems having various modulation schemes, the amount of calibration and look-up tables can become unmanageable.

LOG Amp Detectors

LOG Amp detectors are widely used RF power detectors for GSM and the early W-CDMA systems. The transfer function of a LOG amp detector has a linear-in-dB response, which means that the output in volts changes linearly with the RF power in dBm. This is convenient since most communication standards specify transmit power levels in dBm as well. LOG amp detectors implement the logarithmic function by a piecewise linear approximation. Consequently, the LOG amp detector does not implement an exact power measurement, which implies a dependency on the signal shape. In systems using various modulation schemes calibration and lookup tables might be required.

RMS Detectors

An RMS detector has a response that is insensitive to the signal shape and modulation form. This is because its operation is based on exact determination of the average power, i.e. it implements:

$$V_{\text{RMS}} = \sqrt{\frac{1}{T} \int v(t)^2 dt} \quad (3)$$

RMS detectors are particularly suited for the newer communication standards like W-CDMA and LTE that exhibit large peak-to-average ratios and different modulation schemes (signal shapes). This is a key advantage compared to other types of detectors in applications that employ signals with high peak-to-average power variations or different modulation schemes. For example, the RMS detector response to a 0 dBm modulated W-CDMA signal and a 0 dBm unmodulated carrier is essentially equal. This eliminates the need for long calibration procedures and large calibration tables in the application due to different applied modulation schemes.

LMH2120 RF POWER DETECTOR

For optimal performance, the LMH2120 needs to be configured correctly in the application. The detector will be discussed by means of its block diagram (Figure 57). Details of the electrical interfacing are separately discussed for each pin below.

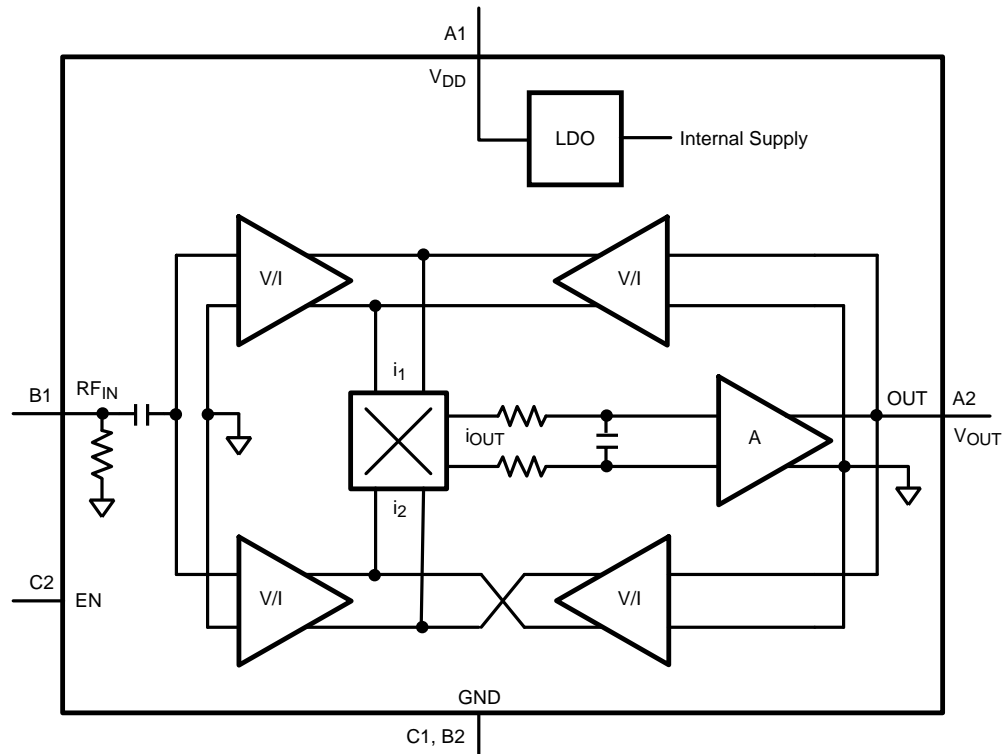

Figure 57. Block Diagram

For measuring the RMS (power) level of a signal, the time average of the squared signal needs to be measured as described in section [ACCURATE POWER MEASUREMENT](#). This is implemented in the LMH2120 by means of a multiplier and a low-pass filter in a negative-feedback loop. A simplified block diagram of the LMH2120 is depicted in Figure 57. The core of the loop is a multiplier. The two inputs of the multiplier are fed by (i_1, i_2) :

$$i_1 = i_{LF} + i_{RF} \quad (4)$$

$$i_2 = i_{LF} - i_{RF} \quad (5)$$

in which i_{LF} is a current depending on the DC output voltage of the RF detector and i_{RF} is a current depending on the RF input signal. The output of the multiplier (i_{OUT}) is the product of these two current and equals:

$$i_{OUT} = \frac{i_{LF}^2 - i_{RF}^2}{I_0} \quad (6)$$

in which I_0 is a normalizing current. By a low-pass filter at the output of the multiplier the DC term of this current is isolated and integrated. The input of the amplifier A acts as the nulling point of the negative feedback loop, yielding:

$$\int i_{LF}^2 dt = \int i_{RF}^2 dt \quad (7)$$

which implies that the average power content of the current related to the output voltage of the LMH2120 is made equal to the average power content of the current related to the RF input signal.

For a negative-feedback system, the transfer function is given by the inverse function of the feedback block. Therefore, to have a linear transfer for this RF detector, the feedback network implements a linear function as well resulting in an overall transfer function for the LMH2120 of:

$$V_{OUT} = k \sqrt{\int V_{RF}^2 dt} \quad (8)$$

in which k is the conversion gain. Note that as a result of the feedback loop a square root is also implemented, yielding the RMS function.

Given this architecture for the RF detector, the high performance of the LMH2120 can be understood. In theory the accuracy of the linear transfer is set by:

- The linear feedback network, which basically needs to process a DC signal only.
- A high loop gain for the feedback loop, which is ensured by the amplifier gain A .

The RMS functionality is inherent to the feedback loop and the use of a multiplier. Thus, a very accurate LIN-RMS RF power detector is obtained.

To ensure a low dependency on the supply voltage, the internal detector circuitry is supplied via a low drop-out (LDO) regulator. This enables the usage of a wide range of supply voltage (2.7V to 5V) in combination with a low sensitivity of the output signal for the external supply voltage.

RF Input

RF systems typically use a characteristic impedance of 50Ω ; the LMH2120 is no exception to this. The RF input pin of the LMH2120 has an input impedance of 50Ω . It enables an easy, direct connection to a directional coupler without the need for additional components (Figure 54). For an accurate power measurement the input power range of the LMH2120 needs to be aligned with the output power range of the power amplifier. This can be done by selecting a directional coupler with the appropriate coupling factor.

Since the LMH2120 has a constant input impedance, a resistive divider can also be used instead of a directional coupler (Figure 58).

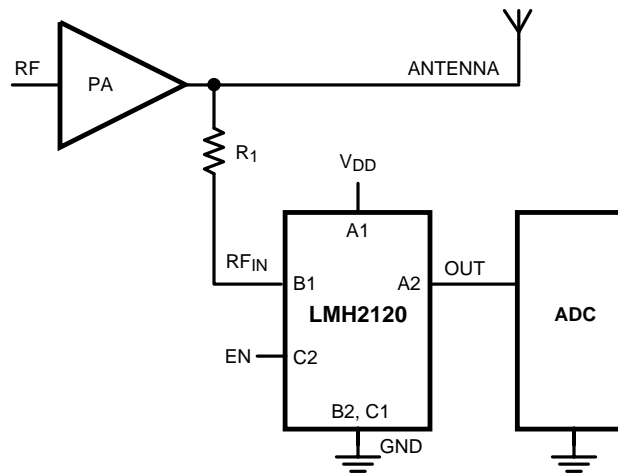

Figure 58. Application with Resistive Divider

Resistor R_1 implements an attenuator, together with the detector input impedance, to match the output range of the PA with the input range of the LMH2120. The attenuation (A_{dB}) realized by R_1 and the effective input impedance (R_{IN}) of the LMH2120 equals:

$$A_{dB} = 20 \text{LOG} \left[1 + \frac{R_1}{R_{IN}} \right] \quad (9)$$

Solving this expression for R_1 yields:

$$R_1 = \left[10^{\frac{A_{dB}}{20}} - 1 \right] R_{IN} \quad (10)$$

Suppose the desired attenuation is 30 dB with a given LMH2120 input impedance of 50Ω, the resistor R_1 needs to be 1531Ω. A practical value is 1.5 kΩ. Although this is a cheaper solution than the application with directional coupler, it has a disadvantage. After calculating the resistor value it is possible that the realized attenuation is less than expected. This is because of the parasitic capacitance of resistor R_1 which results in a lower actual realized attenuation. Whether the attenuation will be reduced depends on the frequency of the RF signal and the parasitic capacitance of resistor R_1 . Since the parasitic capacitance varies from resistor to resistor, exact determination of the realized attenuation can be difficult. A way to reduce the parasitic capacitance of resistor R_1 is to realize it as a series connection of several separate resistors.

Enable

To save power, the LMH2120 can be brought into a low-power shutdown mode by means of the enable pin (EN). The device is active for EN = HIGH ($V_{EN} > 1.1V$), and in the low-power shutdown mode for EN = LOW ($V_{EN} < 0.6V$). In this state the output of the LMH2120 is switched to high-impedance. This high impedance prevents the discharge of the optional low-pass filter which is good for power efficiency. Using the shutdown function, care must be taken not to exceed the absolute maximum ratings. Since the device has an internal operating voltage of 2.5V, the voltage level on the enable should not be higher than 3V to prevent excess current flowing into the enable pin. Also enable voltage levels lower than 400 mV below GND should be prevented. In both cases the ESD devices start to conduct when the enable voltage range is exceeded and excess current will be drawn. A correct operation is not ensured then. The absolute maximum ratings are also exceeded when EN is switched to HIGH (from shutdown to active mode) while the supply voltage is switched off. This situation should be prevented at all times. A possible solution to protect the device is to add a resistor of 1 kΩ in series with the enable input to limit the current.

Output

The output of the LMH2120 provides a DC voltage that is a measure for the applied RF power to the input pin. The output voltage has a linear-in-V response for an applied RF signal.

RF power detectors can have some residual ripple on the output due to the modulation of the applied RF signal. The residual ripple on the LMH2120's output is small; therefore, additional filtering is usually not needed. This is because its internal averaging mechanism reduces the ripple significantly. For some modulation types having very high peak-to-average ratios or low-frequency components in the amplitude modulation, additional filtering might be useful.

Filtering can be applied by an external low-pass filter. It should be realized that filtering reduces not only the ripple, but also increases the response time. In other words, it takes longer before the output reaches its final value. A trade-off should be made between allowed ripple and allowed response time. The filtering technique is depicted in Figure 59. The low-pass output filter is realized by resistor R_S and capacitor C_S . The -3 dB bandwidth of this filter can be calculated by:

$$f_{-3\text{ dB}} = 1 / (2\pi R_S C_S) \quad (11)$$

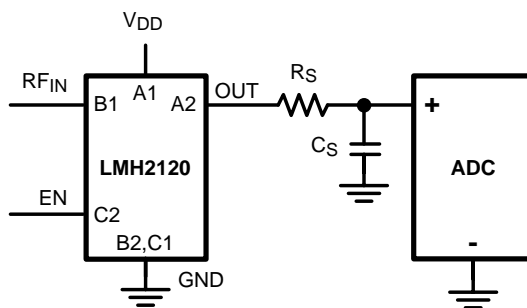

Figure 59. Low-Pass Output Filter for Residual Ripple Reduction

The output impedance of the LMH2120 is HIGH in shutdown. This is especially beneficial in pulsed mode systems. It ensures a fast settling time when the device returns from shutdown into active mode and reduces power consumption.

In pulse mode systems, the device is active only during a fraction of the time. During the remaining time the device is in low-power shutdown. Pulsed mode system applications usually require that the output value is available at all times. This can be realized by a capacitor connected between the output and GND that “stores” the output voltage level. To apply this principle, discharging of the capacitor should be minimized in shutdown mode. The connected ADC input should thus have a high input impedance to prevent a possible discharge path through the ADC. When an additional filter is applied at the output, the capacitor of the RC-filter can be used to store the output value. An LMH2120 with a high-impedance shutdown mode saves power in pulse mode systems. This is because the capacitor C_S doesn't need to be fully recharged each cycle.

Supply

The LMH2120 has an internal LDO to handle supply voltages between 2.7V to 5V. This enables a direct connection to the battery in cell phone applications. The high PSRR of the LMH2120 ensures that the performance is constant over its power supply range.

SPECIFYING DETECTOR PERFORMANCE

The performance of the LMH2120 can be expressed by a variety of parameters. This section discusses the key parameters.

Dynamic Range

The LMH2120 is designed to have a predictable and accurate response over a certain input power range. This is called the dynamic range (DR) of a detector. For determining the dynamic range a couple of different criteria can be used. The most commonly used ones are:

- Linear conformance error, E_{LC}
- Variation over temperature error, E_{VOT}
- 1 dB step error, $E_{1\text{ dB}}$
- Variation due to Modulation, E_{MOD}

The specified dynamic range is the range in which the specified error metric is within a predefined window. An explanation of these errors is given in the following paragraphs.

Linear Conformance error

The LMH2120 implements a linear detection function. In order to describe how close the transfer is to an ideal linear function the linear conformance error is used. To calculate the linear conformance error the detector transfer function is modeled as a linear-in-V relationship between the input power and the output voltage.

The ideal linear-in-V transfer is modeled by 2 parameters:

- Slope, K_{SLOPE}
- Intercept, P_{INT}

and is described by:

$$V_{OUT} = K_{SLOPE} (P_{IN} - P_{INT}) \quad (12)$$

where V_{OUT} is the output voltage in dBV, K_{SLOPE} is the slope of the function in dB/dB, P_{IN} the input power level in dBm and P_{INT} is the power level in dBm at which the function intersects $V_{OUT} = 0\text{ dBV} = 1\text{ V}$ (See [Figure 60](#)).

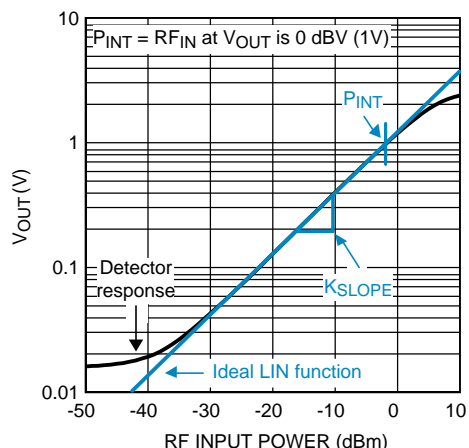

Figure 60. Ideal Linear Response

To determine the linear conformance error two steps are required:

1. Determine the best fitted line at 25°C.
2. Determine the difference between the actual data and the best fitted line.

The best fit can be determined by standard routines. A careful selection of the fit range is important. The fit range should be within the normal range of operation of the device. Outcome of the fit is K_{SLOPE} and P_{INT} .

Subsequently, the difference between the actual data and the best fitted line is determined. The linear conformance is specified as an input referred error. The output referred error is therefore divided by the K_{SLOPE} to obtain the input referred error. The linear conformance error is calculated by the following equation:

$$E_{LC(T)} = \frac{V_{OUT(T)} - K_{SLOPE\ 25^{\circ}C}(P_{IN} - P_{INT\ 25^{\circ}C})}{K_{SLOPE\ 25^{\circ}C}} \quad (13)$$

where $V_{OUT(T)}$ is the measured output voltage at a power level at P_{IN} at a specific temperature. $K_{SLOPE\ 25^{\circ}C}$ (dB/dB) and $P_{INT\ 25^{\circ}C}$ (dBm) are the parameters of the best fitted line of the 25°C transfer.

Figure 61 shows that both the error with respect to the ideal LIN response as well as the error due to temperature variation are included in this error metric. This is because the measured data for all temperatures is compared to the fitted line at 25°C. The measurement result of a typical LMH2120 in Figure 61 shows a dynamic range of 35 dB for $E_{LC} = \pm 1$ dB.

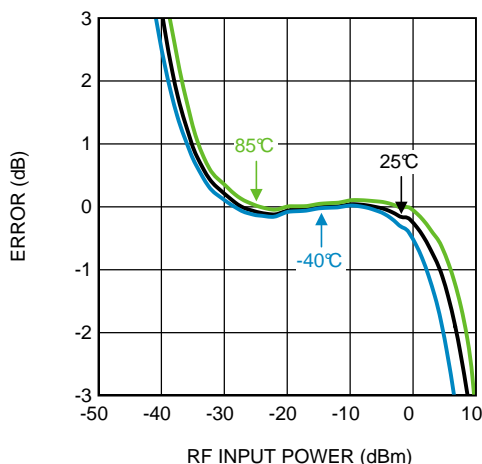

Figure 61. E_{LC} vs. RF input Power at 1900 MHz

Variation over Temperature Error

In contrast to the linear conformance error, the variation over temperature error (E_{VOT}) purely measures the error due to temperature variation. The measured output voltage at 25°C is subtracted from the output voltage at another temperature. Subsequently, it is translated into an input referred error by dividing it by K_{SLOPE} at 25°C. The equation for variation over temperature is given by:

$$E_{VOT} = (V_{OUT_TEMP} - V_{OUT\ 25^\circ C}) / K_{SLOPE} \quad (14)$$

The variation over temperature is shown in Figure 62, where a dynamic range of 40 dB is obtained for $E_{VOT} = \pm 0.5$ dB.

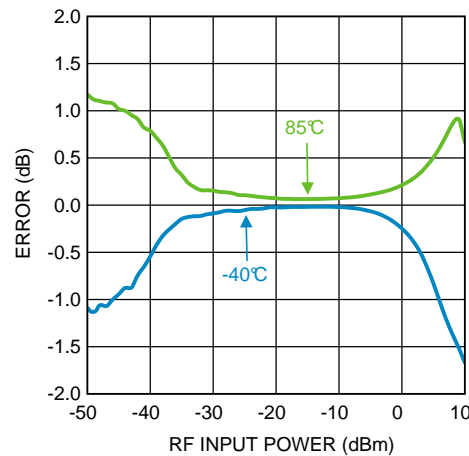

Figure 62. E_{VOT} vs. RF Input Power at 1900 MHz

1 dB Step Error

This parameter is a measure for the error for an 1 dB power step. According to a 3GPP specification, the error should be less than ± 0.3 dB. This condition is often used to define a useful dynamic range of the detector.

The 1 dB step error is calculated in 2 steps:

1. Determine the maximum sensitivity.
2. Calculate the 1 dB step error.

First the maximum sensitivity (S_{MAX}) is calculated per temperature. It is defined as the maximum difference between two output voltages for a 1 dB step within the power range:

$$S_{MAX} = V_{OUT\ P+1} - V_{OUT\ P} \quad (15)$$

The 1dB error is then calculated by:

$$E_{1\ dB} = (S_{ACTUAL} - S_{MAX}) / S_{MAX} \quad (16)$$

where S_{ACTUAL} (actual sensitivity) is the difference between two output voltages for a 1 dB step at a given power level. Figure 63 shows the typical 1 dB step error at 1900 MHz, where a dynamic range of 36 dB over temperature is obtained for $E_{1dB} = \pm 0.3$ dB.

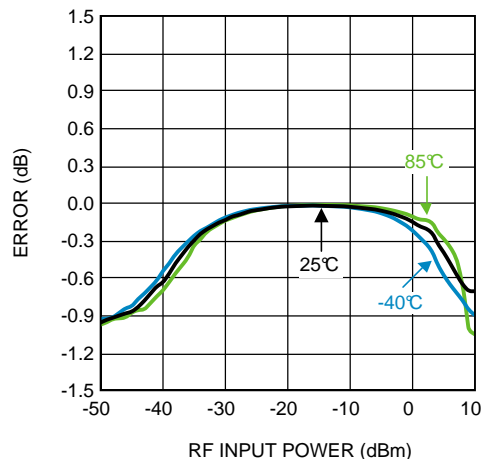

Figure 63. 1 dB Step Error vs. RF Input Power at 1900 MHz

10 dB step error

This error is defined in a different manner than the 1 dB step error. This parameter shows the input power error over temperature for a 10 dB power step. The 10 dB step at 25°C is taken as a reference.

To determine the 10 dB step error first the output voltage levels (V_1 and V_2) for power levels “P” and “P+10dB” at the 25°C are determined (Figure 64). Subsequently these 2 output voltages are used to determine the corresponding power levels at temperature T (P_T and P_T+X). The difference between those two power levels minus 10 results in the 10 dB step error.

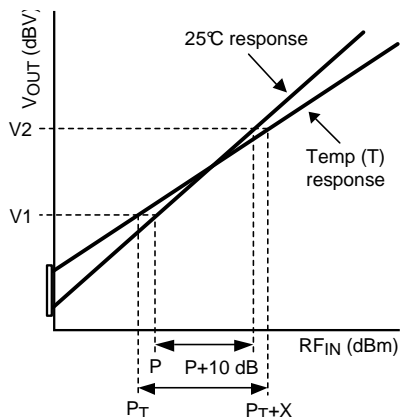

Figure 64. Graphical Representation of 10 dB Step Error Calculations

Figure 65 shows the typical 10 dB step error at 1900 MHz, where a dynamic range of 35 dB is obtained for $E_{10dB} = \pm 1dB$.

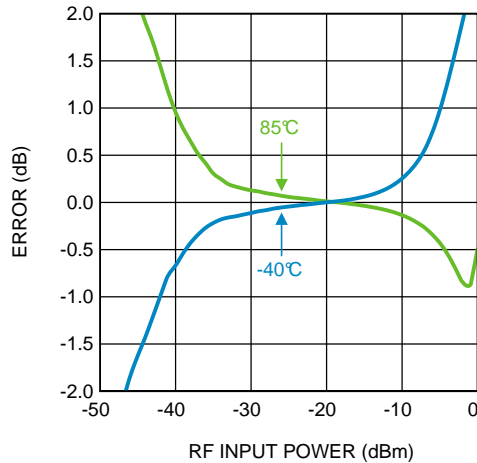

Figure 65. 10 dB Step Error vs. RF Input Power at 1900 MHz

Variation due to Modulation

RMS power detectors, such as the LMH2120 are inherently insensitive to different modulation schemes. This in contrast to traditional detectors like peak detectors and LOG AMP detectors, where modulation forms with high peak-to-average ratios (PAR) can cause significant output variation. This is because the measurement of these detectors is not an actual RMS measurement and is therefore waveform dependent.

To be able to compare the various detector types on modulation sensitivity, the variation due to modulation parameter is used. To calculate the variation due to modulation (E_{MOD}), the measurement result for an unmodulated RF carrier is subtracted from the measurement result for a modulated RF carrier. The calculations are similar to those for variation over temperature. The variation due to modulation can be calculated by:

$$E_{MOD} = (V_{OUT_MOD} - V_{OUT_CW}) / K_{SLOPE} \tag{17}$$

where V_{OUT_MOD} is the measured output voltage for an applied power level of a modulated signal, V_{OUT_CW} is the output voltage as a result of an applied un-modulated signal having the same power level.

Figure 66 shows the variation due to modulation for W-CDMA, where a E_{MOD} of 0.16 dB is obtained for a dynamic range from -34 dBm to -2 dBm.

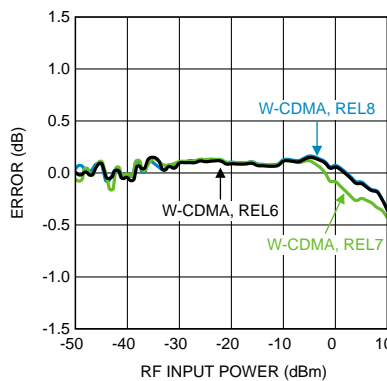

Figure 66. Variation due to Modulation for W-CDMA at 1900 MHz

TEMPERATURE BEHAVIOR

The specified temperature range of the LMH2120 is from -40°C to 85°C. The RF detector is, to a certain extent however, still functional outside these temperature limits. Figure 67, Figure 68, and Figure 69 show the detector behavior for temperatures from -50°C up to 125°C in steps of 25°C. The LMH2120 is still very accurate within a dynamic range from -35 dBm to 5 dBm. On the upper and lower end of the curves deviate in a gradual way, the lowest temperature on the bottom side and the highest temperature on top side.

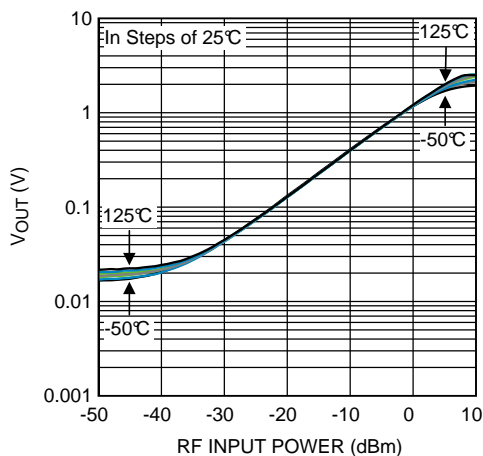

Figure 67. V_{OUT} vs. RF Input Power at 1900 MHz

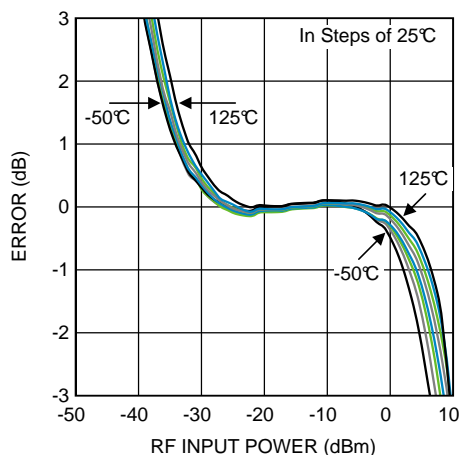

Figure 68. Linear Conformance Error vs. RF Input Power at 1900 MHz

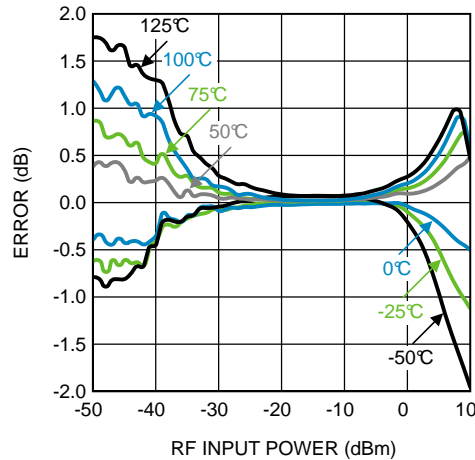

Figure 69. Temperature Variation vs. RF Input Power at 1900 MHz

Layout Recommendations

As with any other RF device, careful attention must be paid to the board layout. If the board layout isn't properly designed, performance might be less than can be expected for the application.

The LMH2120 is designed to be used in RF applications, having a characteristic impedance of 50Ω . To achieve this impedance, the input of the LMH2120 needs to be connected via a 50Ω transmission line. Transmission lines can be created on PCBs using microstrip or (grounded) coplanar waveguide (GCPW) configurations.

In order to minimize injection of RF interference into the LMH2120 through the supply lines, the PCB traces for V_{DD} and GND should be minimized for RF signals. This can be done by placing a decoupling capacitor between the V_{DD} and GND. It should be placed as close as possible, to the V_{DD} and GND pins of the LMH2120.

REVISION HISTORY

Changes from Revision B (February 2013) to Revision C	Page
• Changed layout of National Data Sheet to TI format	28

PACKAGING INFORMATION

Orderable Device	Status (1)	Package Type	Package Drawing	Pins	Package Qty	Eco Plan (2)	Lead/Ball Finish (6)	MSL Peak Temp (3)	Op Temp (°C)	Device Marking (4/5)	Samples
LMH2120UM/NOPB	NRND	DSBGA	YFZ	6	250	Green (RoHS & no Sb/Br)	SNAGCU	Level-1-260C-UNLIM	-40 to 85	R	
LMH2120UMX/NOPB	NRND	DSBGA	YFZ	6	3000	Green (RoHS & no Sb/Br)	SNAGCU	Level-1-260C-UNLIM	-40 to 85	R	

(1) The marketing status values are defined as follows:

ACTIVE: Product device recommended for new designs.

LIFEBUY: TI has announced that the device will be discontinued, and a lifetime-buy period is in effect.

NRND: Not recommended for new designs. Device is in production to support existing customers, but TI does not recommend using this part in a new design.

PREVIEW: Device has been announced but is not in production. Samples may or may not be available.

OBSOLETE: TI has discontinued the production of the device.

(2) **RoHS:** TI defines "RoHS" to mean semiconductor products that are compliant with the current EU RoHS requirements for all 10 RoHS substances, including the requirement that RoHS substance do not exceed 0.1% by weight in homogeneous materials. Where designed to be soldered at high temperatures, "RoHS" products are suitable for use in specified lead-free processes. TI may reference these types of products as "Pb-Free".

RoHS Exempt: TI defines "RoHS Exempt" to mean products that contain lead but are compliant with EU RoHS pursuant to a specific EU RoHS exemption.

Green: TI defines "Green" to mean the content of Chlorine (Cl) and Bromine (Br) based flame retardants meet JS709B low halogen requirements of <=1000ppm threshold. Antimony trioxide based flame retardants must also meet the <=1000ppm threshold requirement.

(3) MSL, Peak Temp. - The Moisture Sensitivity Level rating according to the JEDEC industry standard classifications, and peak solder temperature.

(4) There may be additional marking, which relates to the logo, the lot trace code information, or the environmental category on the device.

(5) Multiple Device Markings will be inside parentheses. Only one Device Marking contained in parentheses and separated by a "~" will appear on a device. If a line is indented then it is a continuation of the previous line and the two combined represent the entire Device Marking for that device.

(6) Lead/Ball Finish - Orderable Devices may have multiple material finish options. Finish options are separated by a vertical ruled line. Lead/Ball Finish values may wrap to two lines if the finish value exceeds the maximum column width.

Important Information and Disclaimer:The information provided on this page represents TI's knowledge and belief as of the date that it is provided. TI bases its knowledge and belief on information provided by third parties, and makes no representation or warranty as to the accuracy of such information. Efforts are underway to better integrate information from third parties. TI has taken and continues to take reasonable steps to provide representative and accurate information but may not have conducted destructive testing or chemical analysis on incoming materials and chemicals. TI and TI suppliers consider certain information to be proprietary, and thus CAS numbers and other limited information may not be available for release.

In no event shall TI's liability arising out of such information exceed the total purchase price of the TI part(s) at issue in this document sold by TI to Customer on an annual basis.

TAPE AND REEL INFORMATION

QUADRANT ASSIGNMENTS FOR PIN 1 ORIENTATION IN TAPE

*All dimensions are nominal

Device	Package Type	Package Drawing	Pins	SPQ	Reel Diameter (mm)	Reel Width W1 (mm)	A0 (mm)	B0 (mm)	K0 (mm)	P1 (mm)	W (mm)	Pin1 Quadrant
LMH2120UM/NOPB	DSBGA	YFZ	6	250	178.0	8.4	0.89	1.3	0.56	4.0	8.0	Q1
LMH2120UMX/NOPB	DSBGA	YFZ	6	3000	178.0	8.4	0.89	1.3	0.56	4.0	8.0	Q1

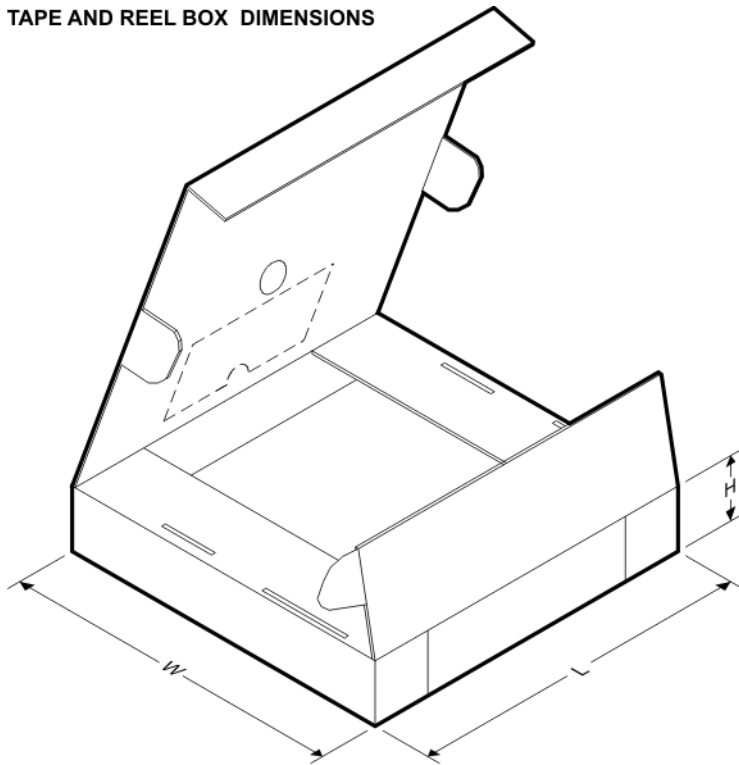
TAPE AND REEL BOX DIMENSIONS

*All dimensions are nominal

Device	Package Type	Package Drawing	Pins	SPQ	Length (mm)	Width (mm)	Height (mm)
LMH2120UM/NOPB	DSBGA	YFZ	6	250	210.0	185.0	35.0
LMH2120UMX/NOPB	DSBGA	YFZ	6	3000	210.0	185.0	35.0

YFZ0006

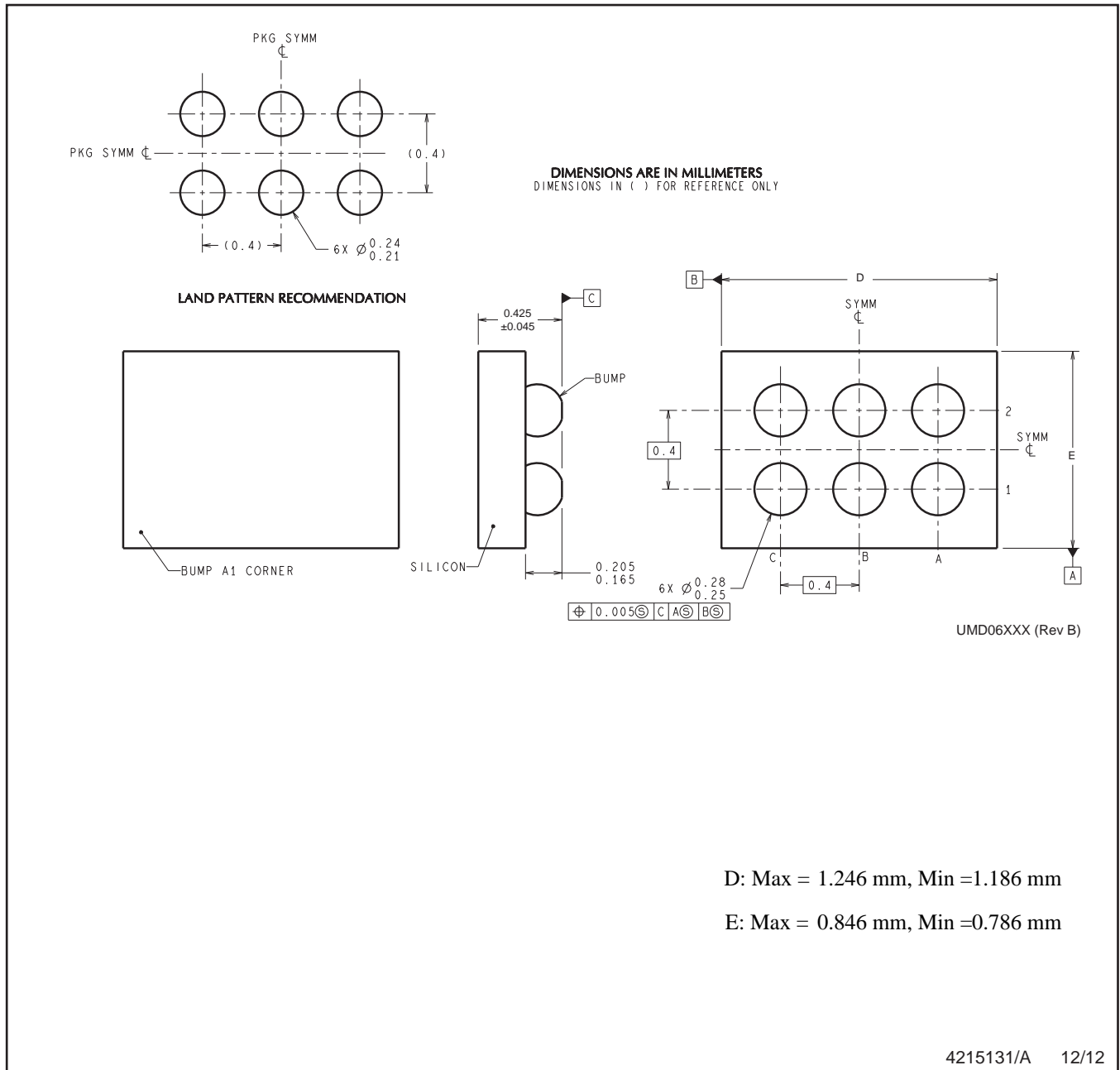

D: Max = 1.246 mm, Min = 1.186 mm

E: Max = 0.846 mm, Min = 0.786 mm

4215131/A 12/12

NOTES: A. All linear dimensions are in millimeters. Dimensioning and tolerancing per ASME Y14.5M-1994.
B. This drawing is subject to change without notice.

IMPORTANT NOTICE

Texas Instruments Incorporated (TI) reserves the right to make corrections, enhancements, improvements and other changes to its semiconductor products and services per JESD46, latest issue, and to discontinue any product or service per JESD48, latest issue. Buyers should obtain the latest relevant information before placing orders and should verify that such information is current and complete.

TI's published terms of sale for semiconductor products (<http://www.ti.com/sc/docs/stdterms.htm>) apply to the sale of packaged integrated circuit products that TI has qualified and released to market. Additional terms may apply to the use or sale of other types of TI products and services.

Reproduction of significant portions of TI information in TI data sheets is permissible only if reproduction is without alteration and is accompanied by all associated warranties, conditions, limitations, and notices. TI is not responsible or liable for such reproduced documentation. Information of third parties may be subject to additional restrictions. Resale of TI products or services with statements different from or beyond the parameters stated by TI for that product or service voids all express and any implied warranties for the associated TI product or service and is an unfair and deceptive business practice. TI is not responsible or liable for any such statements.

Buyers and others who are developing systems that incorporate TI products (collectively, "Designers") understand and agree that Designers remain responsible for using their independent analysis, evaluation and judgment in designing their applications and that Designers have full and exclusive responsibility to assure the safety of Designers' applications and compliance of their applications (and of all TI products used in or for Designers' applications) with all applicable regulations, laws and other applicable requirements. Designer represents that, with respect to their applications, Designer has all the necessary expertise to create and implement safeguards that (1) anticipate dangerous consequences of failures, (2) monitor failures and their consequences, and (3) lessen the likelihood of failures that might cause harm and take appropriate actions. Designer agrees that prior to using or distributing any applications that include TI products, Designer will thoroughly test such applications and the functionality of such TI products as used in such applications.

TI's provision of technical, application or other design advice, quality characterization, reliability data or other services or information, including, but not limited to, reference designs and materials relating to evaluation modules, (collectively, "TI Resources") are intended to assist designers who are developing applications that incorporate TI products; by downloading, accessing or using TI Resources in any way, Designer (individually or, if Designer is acting on behalf of a company, Designer's company) agrees to use any particular TI Resource solely for this purpose and subject to the terms of this Notice.

TI's provision of TI Resources does not expand or otherwise alter TI's applicable published warranties or warranty disclaimers for TI products, and no additional obligations or liabilities arise from TI providing such TI Resources. TI reserves the right to make corrections, enhancements, improvements and other changes to its TI Resources. TI has not conducted any testing other than that specifically described in the published documentation for a particular TI Resource.

Designer is authorized to use, copy and modify any individual TI Resource only in connection with the development of applications that include the TI product(s) identified in such TI Resource. NO OTHER LICENSE, EXPRESS OR IMPLIED, BY ESTOPPEL OR OTHERWISE TO ANY OTHER TI INTELLECTUAL PROPERTY RIGHT, AND NO LICENSE TO ANY TECHNOLOGY OR INTELLECTUAL PROPERTY RIGHT OF TI OR ANY THIRD PARTY IS GRANTED HEREIN, including but not limited to any patent right, copyright, mask work right, or other intellectual property right relating to any combination, machine, or process in which TI products or services are used. Information regarding or referencing third-party products or services does not constitute a license to use such products or services, or a warranty or endorsement thereof. Use of TI Resources may require a license from a third party under the patents or other intellectual property of the third party, or a license from TI under the patents or other intellectual property of TI.

TI RESOURCES ARE PROVIDED "AS IS" AND WITH ALL FAULTS. TI DISCLAIMS ALL OTHER WARRANTIES OR REPRESENTATIONS, EXPRESS OR IMPLIED, REGARDING RESOURCES OR USE THEREOF, INCLUDING BUT NOT LIMITED TO ACCURACY OR COMPLETENESS, TITLE, ANY EPIDEMIC FAILURE WARRANTY AND ANY IMPLIED WARRANTIES OF MERCHANTABILITY, FITNESS FOR A PARTICULAR PURPOSE, AND NON-INFRINGEMENT OF ANY THIRD PARTY INTELLECTUAL PROPERTY RIGHTS. TI SHALL NOT BE LIABLE FOR AND SHALL NOT DEFEND OR INDEMNIFY DESIGNER AGAINST ANY CLAIM, INCLUDING BUT NOT LIMITED TO ANY INFRINGEMENT CLAIM THAT RELATES TO OR IS BASED ON ANY COMBINATION OF PRODUCTS EVEN IF DESCRIBED IN TI RESOURCES OR OTHERWISE. IN NO EVENT SHALL TI BE LIABLE FOR ANY ACTUAL, DIRECT, SPECIAL, COLLATERAL, INDIRECT, PUNITIVE, INCIDENTAL, CONSEQUENTIAL OR EXEMPLARY DAMAGES IN CONNECTION WITH OR ARISING OUT OF TI RESOURCES OR USE THEREOF, AND REGARDLESS OF WHETHER TI HAS BEEN ADVISED OF THE POSSIBILITY OF SUCH DAMAGES.

Unless TI has explicitly designated an individual product as meeting the requirements of a particular industry standard (e.g., ISO/TS 16949 and ISO 26262), TI is not responsible for any failure to meet such industry standard requirements.

Where TI specifically promotes products as facilitating functional safety or as compliant with industry functional safety standards, such products are intended to help enable customers to design and create their own applications that meet applicable functional safety standards and requirements. Using products in an application does not by itself establish any safety features in the application. Designers must ensure compliance with safety-related requirements and standards applicable to their applications. Designer may not use any TI products in life-critical medical equipment unless authorized officers of the parties have executed a special contract specifically governing such use. Life-critical medical equipment is medical equipment where failure of such equipment would cause serious bodily injury or death (e.g., life support, pacemakers, defibrillators, heart pumps, neurostimulators, and implantables). Such equipment includes, without limitation, all medical devices identified by the U.S. Food and Drug Administration as Class III devices and equivalent classifications outside the U.S.

TI may expressly designate certain products as completing a particular qualification (e.g., Q100, Military Grade, or Enhanced Product). Designers agree that it has the necessary expertise to select the product with the appropriate qualification designation for their applications and that proper product selection is at Designers' own risk. Designers are solely responsible for compliance with all legal and regulatory requirements in connection with such selection.

Designer will fully indemnify TI and its representatives against any damages, costs, losses, and/or liabilities arising out of Designer's non-compliance with the terms and provisions of this Notice.

Looking for pricing, stock, or lifecycle information?

Click below to explore more details on WIN SOURCE:

 [View LMH2120UMX/NOPB on WIN SOURCE](#)

 [Texas Instruments](#) Information

Optimize Your Supply Chain with WIN SOURCE Solutions

-  Global Sourcing Solution
-  Obsolete Management
-  Cost Control Management
-  Shortage Management
-  Alternative Solution
-  Excess Inventory Management