



**THE DATASHEET OF
LMC7211AIM5X/NOPB**



LMC7211 Tiny CMOS Comparator with Rail-to-Rail Input and Push-Pull Output

 Check for Samples: [LMC7211-N](#)

FEATURES

- Tiny SOT 23-5 package saves space
- Package is less than 1.43 mm thick
- Guaranteed specs at 2.7V, 5V, 15V supplies
- Typical supply current 7 μ A at 5V
- Response time of 4 μ s at 5V
- Push-pull output
- Input common-mode range beyond V^- and V^+
- Low input current

APPLICATIONS

- Battery Powered Products
- Notebooks and PDAs
- PCMCIA cards
- Mobile Communications
- Alarm and Security circuits
- Direct Sensor Interface
- Replaces amplifiers used as comparators with better performance and lower current

DESCRIPTION

The LMC7211 is a micropower CMOS comparator available in the space saving SOT23-5 package. This makes the comparator ideal for space and weight critical designs. The LMC7211 is supplied in two offset voltage grades, 5 mV and 15 mV.

The main benefits of the Tiny package are most apparent in small portable electronic devices, such as mobile phones, pagers, notebook computers, personal digital assistants, and PCMCIA cards. The rail-to-rail input voltage makes the LMC7211 a good choice for sensor interfacing, such as light detector circuits, optical and magnetic sensors, and alarm and status circuits.

The Tiny Comparator's outside dimensions (length x width x height) of 3.05mm x 3.00mm x 1.43mm allow it to fit into tight spaces on PC boards.

See the LMC7221 for a comparator with an open-drain output.

CONNECTION DIAGRAM

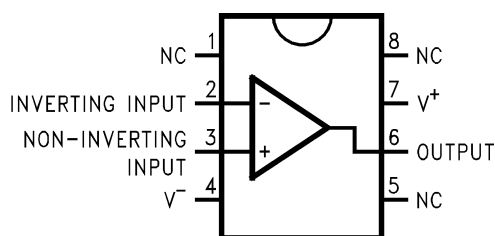

**Figure 1. 8-Pin SOIC-8
Top View**

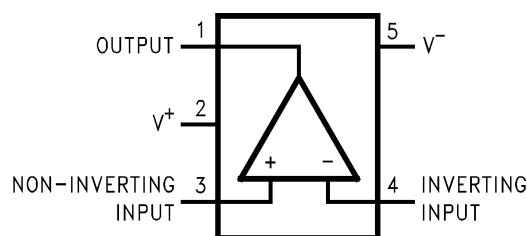

**Figure 2. 5-Pin SOT23-5
Top View**



These devices have limited built-in ESD protection. The leads should be shorted together or the device placed in conductive foam during storage or handling to prevent electrostatic damage to the MOS gates.



Please be aware that an important notice concerning availability, standard warranty, and use in critical applications of Texas Instruments semiconductor products and disclaimers thereto appears at the end of this data sheet.

All trademarks are the property of their respective owners.

Absolute Maximum Ratings ⁽¹⁾

ESD Tolerance ⁽²⁾		2 kV
Differential Input Voltage		$(V_{CC}) + 0.3V$ to $(-V_{CC}) - 0.3V$
Voltage at Input/Output Pin		$(V_{CC}) + 0.3V$ to $(-V_{CC}) - 0.3V$
Supply Voltage ($V^+ - V^-$)		16V
Current at Input Pin ⁽³⁾		± 5 mA
Current at Output Pin ⁽⁴⁾ ⁽⁵⁾		± 30 mA
Current at Power Supply Pin		40 mA
Lead Temperature	(soldering, 10 sec)	260°C
Storage Temperature Range		-65°C to +150°C
Junction Temperature ⁽⁶⁾		150°C

- (1) Absolute Maximum Ratings indicate limits beyond which damage to the device may occur. Operating Ratings indicate conditions for which the device is intended to be functional, but specific performance is not guaranteed. For guaranteed specifications and the test conditions, see the Electrical Characteristics.
- (2) Human body model, 1.5 k Ω in series with 100 pF.
- (3) Limiting input pin current is only necessary for input voltages that exceed absolute maximum input voltage rating.
- (4) Applies to both single-supply and split-supply operation. Continuous short circuit operation at elevated ambient temperature can result in exceeding the maximum allowed junction temperature of 150°C. Output currents in excess of ± 30 mA over long term may adversely affect reliability.
- (5) Do not short circuit output to V^+ , when V^+ is greater than 12V or reliability will be adversely affected.
- (6) The maximum power dissipation is a function of $T_{J(max)}$, θ_{JA} , and T_A . The maximum allowable power dissipation at any ambient temperature is $P_D = (T_{J(max)} - T_A) / \theta_{JA}$. All numbers apply for packages soldered directly into a PC board.

Operating Ratings ⁽¹⁾

Supply Voltage		$2.7 \leq V_{CC} \leq 15V$	
Junction Temperature Range LMC7211AI, LMC7211BI		$-40^\circ C \leq T_J \leq +85^\circ C$	
Thermal Resistance (θ_{JA})	SO-8 Package,	8-Pin Surface Mount	180°C/W
	M05A Package,	5-Pin Surface Mount	325°C/W

- (1) Absolute Maximum Ratings indicate limits beyond which damage to the device may occur. Operating Ratings indicate conditions for which the device is intended to be functional, but specific performance is not guaranteed. For guaranteed specifications and the test conditions, see the Electrical Characteristics.

2.7V Electrical Characteristics

Unless otherwise specified, all limits guaranteed for $T_J = 25^\circ C$, $V^+ = 2.7V$, $V^- = 0V$, $V_{CM} = V_O = V^+ / 2$. **Boldface** limits apply at the temperature extremes.

Symbol	Parameter	Conditions	Typ ⁽¹⁾	LMC7211AI Limit ⁽²⁾	LMC7211BI Limit ⁽²⁾	Units
V_{OS}	Input Offset Voltage		3	5 8	15 18	mV max
TCV_{OS}	Input Offset Voltage Temperature Drift		1.0			$\mu V / ^\circ C$
	Input Offset Voltage Average Drift	See ⁽³⁾	3.3			$\mu V / \text{Month}$
I_B	Input Current		0.04			pA
I_{OS}	Input Offset Current		0.02			pA
CMRR	Common Mode Rejection Ratio	$0V \leq V_{CM} \leq 2.7V$	75			dB
PSRR	Power Supply Rejection Ratio	$2.7V \leq V^+ \leq 15V$	80			dB
A_V	Voltage Gain		100			dB

- (1) Typical values represent the most likely parametric norm.
- (2) All limits are guaranteed by testing or statistical analysis.
- (3) Input offset voltage average drift is calculated by dividing the accelerated operating life V_{OS} drift by the equivalent operational time. This represents worst case input conditions and includes the first 30 days of drift.

2.7V Electrical Characteristics (continued)

Unless otherwise specified, all limits guaranteed for $T_J = 25^\circ\text{C}$, $V^+ = 2.7\text{V}$, $V^- = 0\text{V}$, $V_{\text{CM}} = V_O = V^+/2$. **Boldface** limits apply at the temperature extremes.

Symbol	Parameter	Conditions	Typ ⁽¹⁾	LMC7211AI Limit ⁽²⁾	LMC7211BI Limit ⁽²⁾	Units
CMVR	Input Common-Mode Voltage Range	CMRR > 55 dB	3.0	2.9 2.7	2.9 2.7	V min
		CMRR > 55 dB	-0.3	-0.2 0.0	-0.2 0.0	V max
V _{OH}	Output Voltage High	I _{load} = 2.5 mA	2.5	2.4 2.3	2.4 2.3	V min
V _{OL}	Output Voltage Low	I _{load} = 2.5 mA	0.2	0.3 0.4	0.3 0.4	V max
I _S	Supply Current	V _{OUT} = Low	7	12 14	12 14	μA max

5.0V and 15.0V Electrical Characteristics

Unless otherwise specified, all limits guaranteed for $T_J = 25^\circ\text{C}$, $V^+ = 5.0\text{V}$ and 15V , $V^- = 0\text{V}$, $V_{\text{CM}} = V_O = V^+/2$. **Boldface** limits apply at the temperature extremes.

Symbol	Parameter	Conditions	Typ ⁽¹⁾	LMC7211AI Limit ⁽²⁾	LMC7211BI Limit ⁽²⁾	Units
V _{OS}	Input Offset Voltage		3	5 8	15 18	mV max
TCV _{OS}	Input Offset Voltage Temperature Drift	V ⁺ = 5V	1.0			μV/°C
		V ⁺ = 15V	4.0			
	Input Offset Voltage Average Drift	V ⁺ = 5V	3.3			μV/Month
		V ⁺ = 15V	4.0			
I _B	Input Current		0.04			pA
I _{OS}	Input Offset Current		0.02			pA
CMRR	Common Mode Rejection Ratio	V ⁺ = 5.0V	75			dB
		V ⁺ = 15.0V	82			dB
PSRR	Power Supply Rejection Ratio	5V ≤ V ⁺ ≤ 10V	80			dB
A _V	Voltage Gain		100			dB
CMVR	Input Common-Mode Voltage Range	V ⁺ = 5.0V CMRR > 55 dB	5.3	5.2 5.0	5.2 5.0	V min
		V ⁺ = 5.0V CMRR > 55 dB	-0.3	-0.2 0.0	-0.2 0.0	V max
		V ⁺ = 15.0V CMRR > 55 dB	15.3	15.2 15.0	15.2 15.0	V min
		V ⁺ = 15.0V CMRR > 55 dB	-0.3	-0.2 0.0	-0.2 0.0	V max
V _{OH}	Output Voltage High	V ⁺ = 5V I _{load} = 5 mA	4.8	4.6 4.45	4.6 4.45	V min
		V ⁺ = 15V I _{load} = 5 mA	14.8	14.6 14.45	14.6 14.45	V min
V _{OL}	Output Voltage Low	V ⁺ = 5V I _{load} = 5 mA	0.2	0.40 0.55	0.40 0.55	V max
		V ⁺ = 15V I _{load} = 5 mA	0.2	0.40 0.55	0.40 0.55	V max
I _S	Supply Current	V _{OUT} = Low	7	14 18	14 18	μA max

(1) Typical values represent the most likely parametric norm.

(2) All limits are guaranteed by testing or statistical analysis.

5.0V and 15.0V Electrical Characteristics (continued)

Unless otherwise specified, all limits guaranteed for $T_J = 25^\circ\text{C}$, $V^+ = 5.0\text{V}$ and 15V , $V^- = 0\text{V}$, $V_{\text{CM}} = V_O = V^+/2$. **Boldface** limits apply at the temperature extremes.

Symbol	Parameter	Conditions	Typ ⁽¹⁾	LMC7211AI Limit ⁽²⁾	LMC7211BI Limit ⁽²⁾	Units
I_{SC}	Short Circuit Current	Sourcing	30			mA
		Sinking ⁽³⁾	45			mA

(3) Do not short circuit output to V^+ , when V^+ is greater than 12V or reliability will be adversely affected.

AC Electrical Characteristics

Unless otherwise specified, all limits guaranteed for $T_J = 25^\circ\text{C}$, $V^+ = 5\text{V}$, $V^- = 0\text{V}$, $V_{\text{CM}} = V_O = V^+/2$. **Boldface** limits apply at the temperature extreme.

Symbol	Parameter	Conditions	Typ ⁽¹⁾	LMC7211AI Limit ⁽²⁾	LMC7211BI Limit ⁽²⁾	Units
t_{rise}	Rise Time	$f = 10\text{ kHz}$, $C_L = 50\text{ pF}$, Overdrive = 10 mV ⁽³⁾	0.3			μs
t_{fall}	Fall Time	$f = 10\text{ kHz}$, $C_L = 50\text{ pF}$, Overdrive = 10 mV ⁽³⁾	0.3			μs
t_{PHL}	Propagation Delay (High to Low) ⁽⁴⁾	$f = 10\text{ kHz}$, $C_L = 50\text{ pF}$ ⁽³⁾	10 mV	10		μs
			100 mV	4		
		$V^+ = 2.7\text{V}$, $f = 10\text{ kHz}$, $C_L = 50\text{ pF}$ ⁽³⁾	10 mV	10		μs
			100 mV	4		
t_{PLH}	Propagation Delay (Low to High) ⁽⁴⁾	$f = 10\text{ kHz}$, $C_L = 50\text{ pF}$ ⁽³⁾	10 mV	6		μs
			100 mV	4		
		$V^+ = 2.7\text{V}$, $f = 10\text{ kHz}$, $C_L = 50\text{ pF}$ ⁽³⁾	10 mV	7		μs
			100 mV	4		

- (1) Typical values represent the most likely parametric norm.
- (2) All limits are guaranteed by testing or statistical analysis.
- (3) C_L includes the probe and jig capacitance.
- (4) Input step voltage for propagation delay measurement is 2V.

Typical Performance Characteristics

Single Supply $T_A = 25^\circ\text{C}$ unless specified

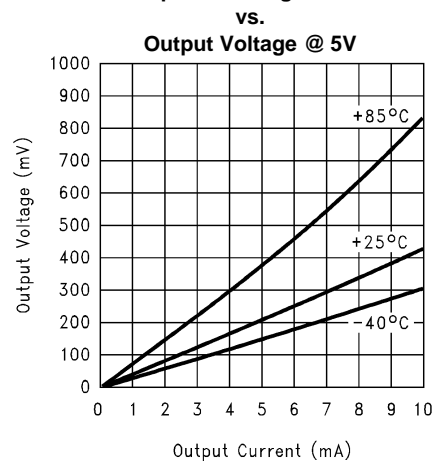
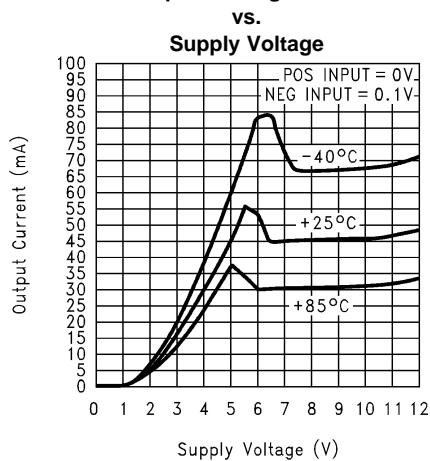
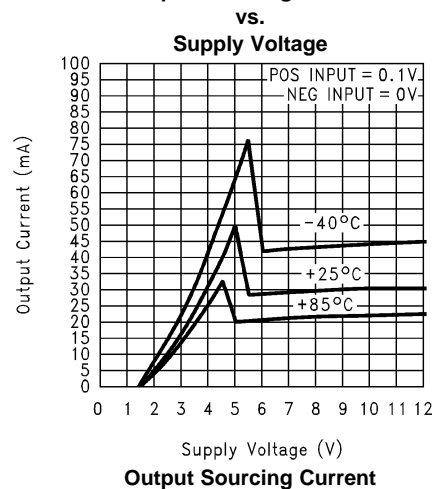
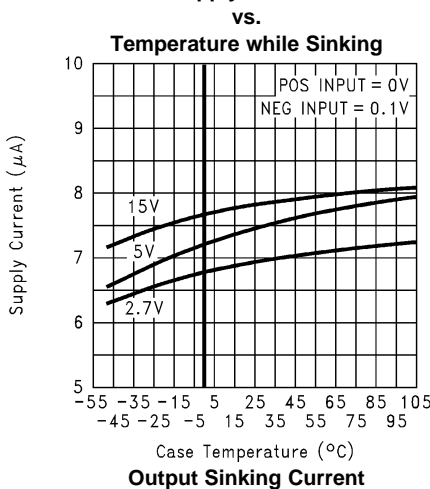
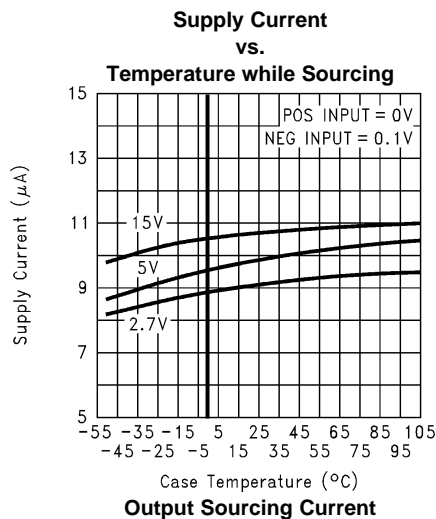
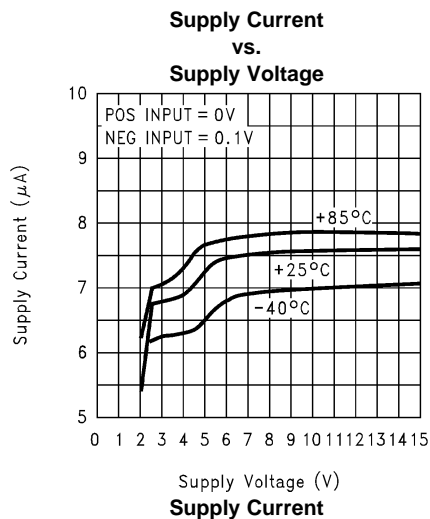

Typical Performance Characteristics (continued)

Single Supply $T_A = 25^\circ\text{C}$ unless specified

Output Sinking Current vs. Output Voltage @ 5V

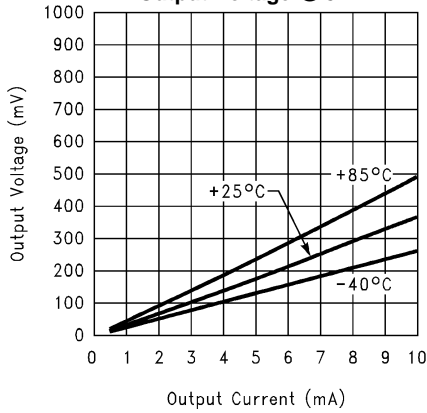

Output Sourcing Current vs. Output Voltage @ 15V

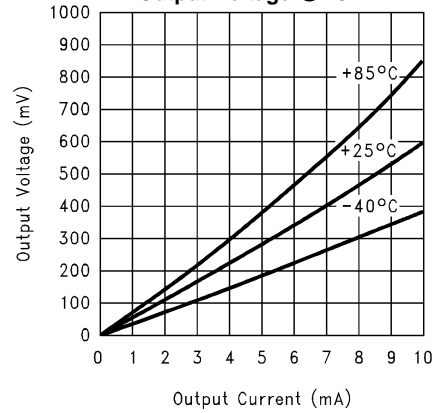

Output Sinking Current vs. Output Voltage @ 15V

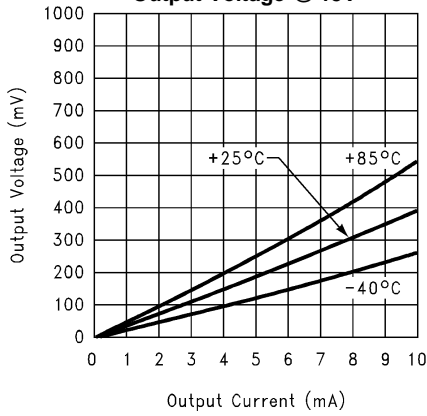

Response Time for Various Input Overdrives - t_{PLH}

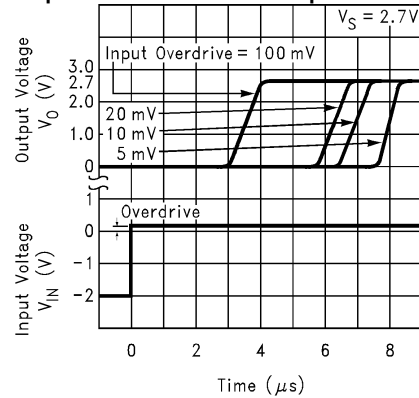

Response Time for Various Input Overdrives - t_{PHL}

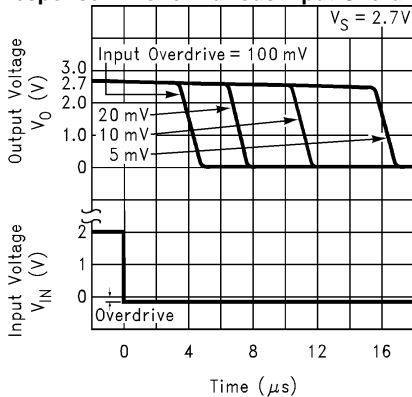

Input Overdrive Referenced to V_{OS}

Response Time for Various Input Overdrives - t_{PLH}

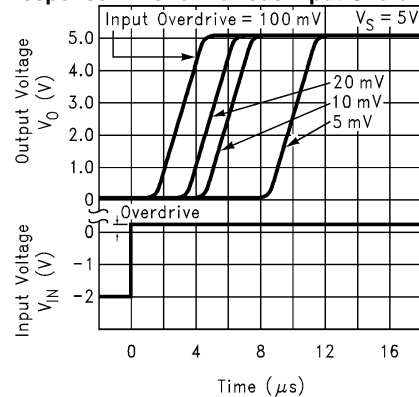

Input Overdrive Referenced to V_{OS}

Typical Performance Characteristics (continued)

Single Supply $T_A = 25^\circ\text{C}$ unless specified

Response Time for Various Input Overdrives $-t_{PHL}$

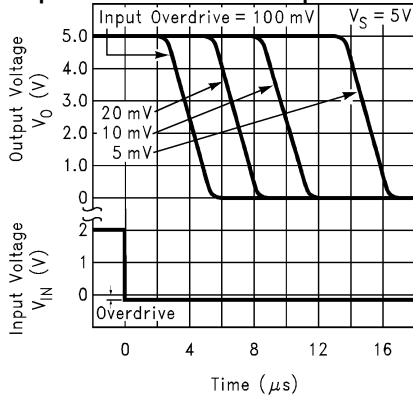

Input Overdrive Referenced to V_{OS}

Response Time for Various Input Overdrives $-t_{PLH}$

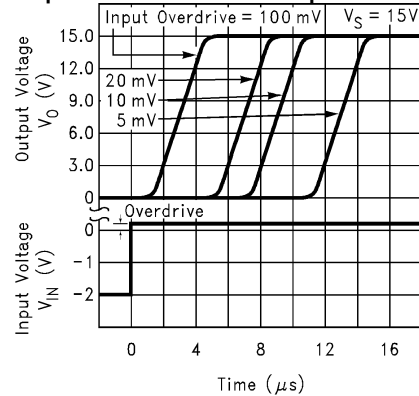

Input Overdrive Referenced to V_{OS}

Response Time for Various Input Overdrives $-t_{PHL}$

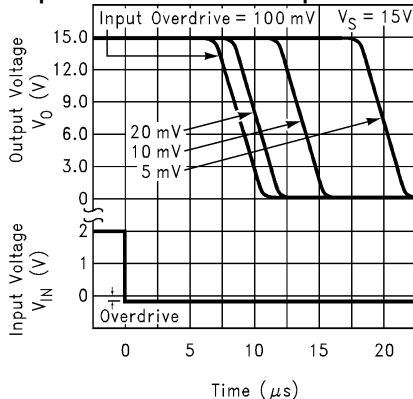

Input Overdrive Referenced to V_{OS}

Input Bias Current vs. Common Mode Voltage

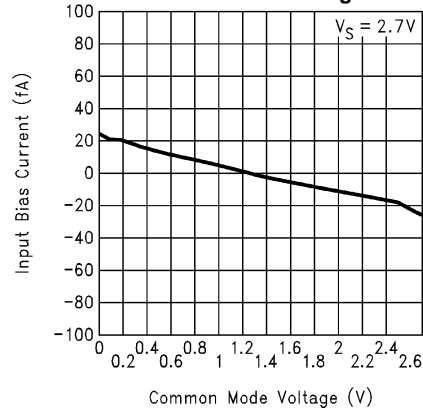

Input Bias Current vs. Common Mode Voltage

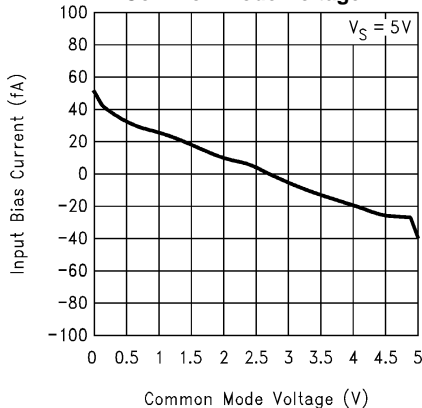

Input Bias Current vs. Common Mode Voltage

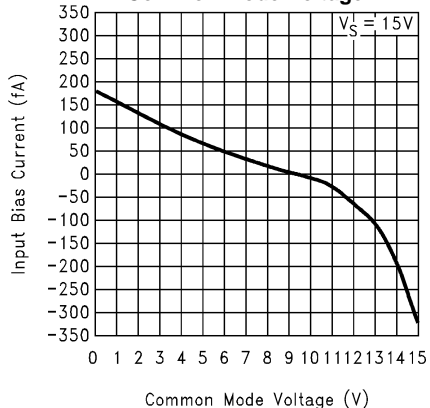

Typical Performance Characteristics (continued)

Single Supply $T_A = 25^\circ\text{C}$ unless specified

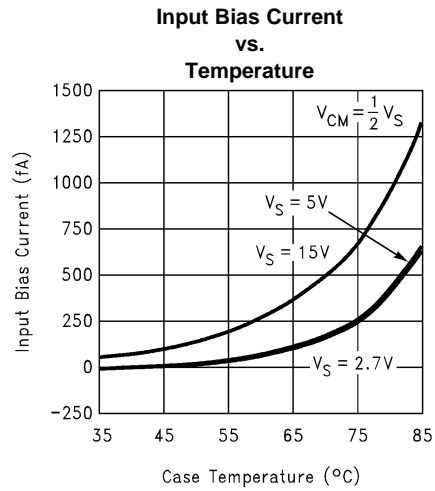

APPLICATION INFORMATION

Benefits of the LMC7211 Tiny Comparator

Size. The small footprint of the SOT 23-5 packaged Tiny Comparator, (0.120 x 0.118 inches, 3.05 x 3.00 mm) saves space on printed circuit boards, and enable the design of smaller electronic products. Because they are easier to carry, many customers prefer smaller and lighter products.

Height. The height (0.056 inches, 1.43 mm) of the Tiny Comparator makes it possible to use it in PCMCIA type III cards.

Simplified Board Layout. The Tiny Comparator can simplify board layout in several ways. First, by placing a comparator where comparators are needed, instead of routing signals to a dual or quad device, long pc traces may be avoided.

By using multiple Tiny Comparators instead of duals or quads, complex signal routing and possibly crosstalk can be reduced.

Low Supply Current. The typical 7 μ A supply current of the LMC7211 extends battery life in portable applications, and may allow the reduction of the size of batteries in some applications.

Wide Voltage Range. The LMC7211 is characterized at 15V, 5V and 2.7V. Performance data is provided at these popular voltages. This wide voltage range makes the LMC7211 a good choice for devices where the voltage may vary over the life of the batteries.

Digital Outputs Representing Signal Level. Comparators provide a high or low digital output depending on the voltage levels of the (+) and (-) inputs. This makes comparators useful for interfacing analog signals to microprocessors and other digital circuits. The LMC7211 can be thought of as a one-bit a/d converter.

Push-Pull Output. The push-pull output of the LMC7211 is capable of both sourcing and sinking milliamp level currents even at a 2.7 volt supply. This can allow the LMC7211 to drive multiple logic gates.

Driving LEDs (Light Emitting Diodes). With a 5 volt power supply, the LMC7211's output sinking current can drive small, high efficiency LEDs for indicator and test point circuits. The small size of the Tiny package makes it easy to find space to add this feature to even compact designs.

Input range to Beyond Rail to Rail. The input common mode range of the LMC7211 is slightly larger than the actual power supply range. This wide input range means that the comparator can be used to sense signals close to the power supply rails. This wide input range can make design easier by eliminating voltage dividers, amplifiers, and other front end circuits previously used to match signals to the limited input range of earlier comparators. This is useful to power supply monitoring circuits which need to sense their own power supply, and compare it to a reference voltage which is close to the power supply voltage. The wide input range can also be useful for sensing the voltage drop across a current sense resistor for battery chargers.

Zero Crossing Detector. Since the LMC7211's common mode input range extends below ground even when powered by a single positive supply, it can be used with large input resistors as a zero crossing detector.

Low Input Currents and High Input Impedance. These characteristics allow the LMC7211 to be used to sense high impedance signals from sensors. They also make it possible to use the LMC7211 in timing circuits built with large value resistors. This can reduce the power dissipation of timing circuits. For very long timing circuits, using high value resistors can reduce the size and cost of large value capacitors for the same R-C time constant.

Direct Sensor Interfacing. The wide input voltage range and high impedance of the LMC7211 may make it possible to directly interface to a sensor without the use of amplifiers or bias circuits. In circuits with sensors which can produce outputs in the tens to hundreds of millivolts, the LMC7211 can compare the sensor signal with an appropriately small reference voltage. This may be done close to ground or the positive supply rail. Direct sensor interfacing may eliminate the need for an amplifier for the sensor signal. Eliminating the amplifier can save cost, space, and design time.

Low Voltage Operation

Comparators are the common devices by which analog signals interface with digital circuits. The LMC7211 has been designed to operate at supply voltages of 2.7V without sacrificing performance to meet the demands of 3V digital systems.

At supply voltages of 2.7V, the common-mode voltage range extends 200 mV (guaranteed) below the negative supply. This feature, in addition to the comparator being able to sense signals near the positive rail, is extremely useful in low voltage applications.

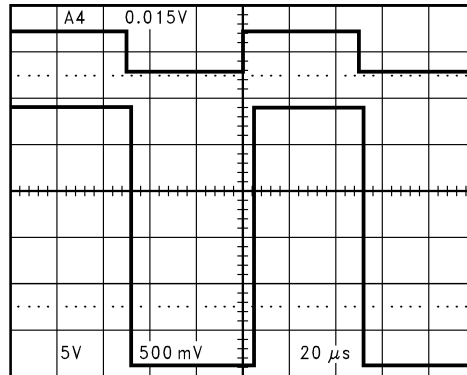

Figure 3. Even at Low-Supply Voltage of 2.7V, an Input Signal which Exceeds the Supply Voltages Produces No Phase Inversion at the Output

At $V^+ = 2.7V$ propagation delays are $t_{PLH} = 4 \mu s$ and $t_{PHL} = 4 \mu s$ with overdrives of 100 mV.

Please refer to the performance curves for more extensive characterization.

Shoot-Through Current

The shoot-through current is defined as the current surge, above the quiescent supply current, between the positive and negative supplies of a device. The current surge occurs when the output of the device switches states. The shoot-through current results in glitches in the supply voltages. Usually, glitches in the supply lines are prevented by bypass capacitors. When the glitches are minimal, the value of the bypass capacitors can be reduced.

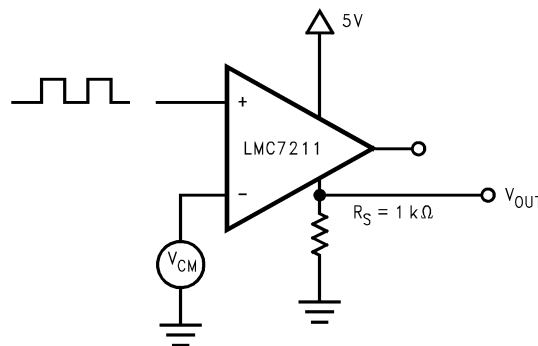

Figure 4. Circuit for Measurement of the Shoot-Through Current

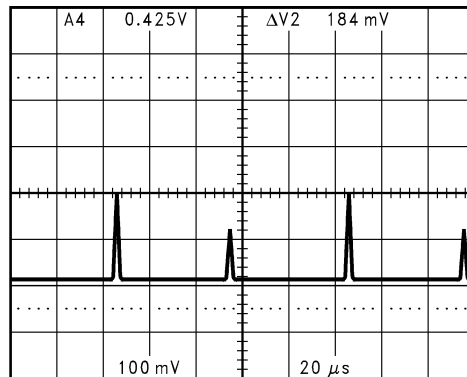
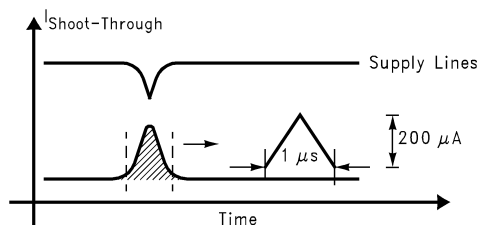

Figure 5. Measurement of the Shoot-Through Current

From [Figure 5](#), the shoot-through current for the LMC7211 can be calculated to be 0.2 mA (typical), and the duration is 1 μs. The values needed for the bypass capacitors can be calculated as follows:



$$\text{Area of } \Delta = \frac{1}{2} (1 \mu\text{s} \times 200 \mu\text{A}) = 100 \text{ pC}$$

The capacitor needs to supply 100 picocoulomb. To avoid large shifts in the comparator threshold due to changes in the voltage level, the voltage drop at the bypass capacitor should be limited to 100 mV or less.

The charge needed (100 picocoulomb) and the allowable voltage drop (100 mV) will give us the minimum capacitor value required.

$$\begin{aligned} \Delta Q &= C (\Delta V) \\ C &= \Delta Q / \Delta V = 100 \text{ picocoulomb} / 100 \text{ mV} \\ C &= 10^{-10} / 10^{-1} = 10^{-9} = 1 \text{ nF} = 0.001 \mu\text{F} \\ 10^{-9} &= 1 \text{ nF} = 0.001 \mu\text{F} \end{aligned}$$

The voltage drop of ~100 mV will cause a threshold shift in the comparator. This threshold shift will be reduced by the power supply rejection ratio, (PSRR). The PSRR which is applicable here is not the DC value of PSRR (~80 dB), but a transient PSRR which will be usually about 20 dB–40 dB, depending on the circuit and the speed of the transient. This will result in an effective threshold shift of about 1 mV to 10 mV.

For precision and level sensing circuits, it is generally a good goal to reduce the voltage delta on the power supply to a value equal to or less than the hysteresis of the comparator circuit. If the above circuit was to be used with 50 mV of hysteresis, it would be reasonable to increase the bypass capacitor to 0.01 μF to reduce the voltage delta to 10 mV. Larger values may be useful for obtaining more accurate and consistent switching.

Note that the switching current of the comparator can spread to other parts of the board as noise. The bypass capacitor reduces this noise. For low noise systems this may be reason to make the capacitor larger.

For non-precision circuits, such as using a comparator to determine if a push-button switch is on or off, it is often cheaper and easier to use a larger value of hysteresis and a small value or bypass capacitance. The low shoot-through current of the LMC7211 can allow the use of smaller and less expensive bypass capacitors in non-critical circuits.

Output Short Circuit Current

The LMC7211 has short circuit protection of 40 mA. However, it is not designed to withstand continuous short circuits, transient voltage or current spikes, or shorts to any voltage beyond the supplies. A resistor in series with the output should reduce the effect of shorts. For outputs which send signals off PC boards additional protection devices, such as diodes to the supply rails, and varistors may be used.

Hysteresis

If the input signal is very slow or very noisy, the comparator output might trip several times as the input signal passes through the threshold. Using positive feedback to add hysteresis to the switching can reduce or eliminate this problem. The positive feedback can be added by a high value resistor (R_F). This will result in two switching thresholds, one for increasing signals and one for decreasing signals. A capacitor can be added across R_F to increase the switching speed and provide more short term hysteresis. This can result in greater noise immunity for the circuit.

See [Figure 6](#), [Figure 7](#) and [Figure 8](#).

Note that very heavy loading of the comparator output, such as LED drive or bipolar logic gates, will change the output voltage and shift the voltage thresholds.

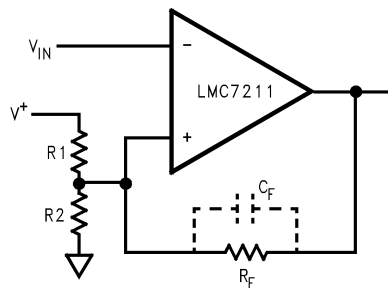

$R_F \gg R_1$ and
 $R_F \gg R_2$

Figure 6. Positive Feedback for Hysteresis

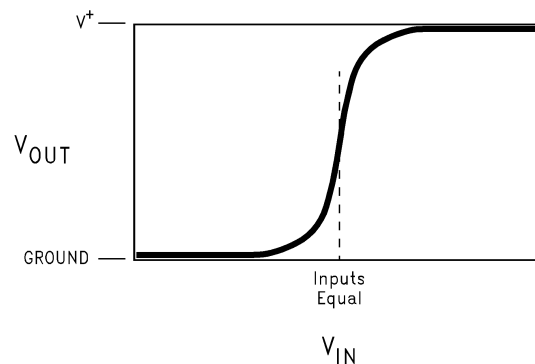

Figure 7. Without Positive Feedback (No Hysteresis)

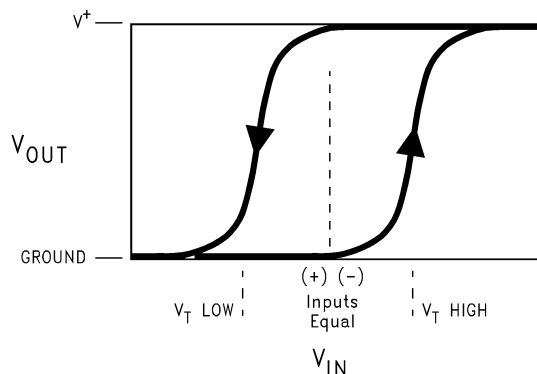

Figure 8. With Positive Feedback (Hysteresis or Memory)

Input Protection

If input signals are like to exceed the common mode range of the LMC7211, or it is likely that signals may be present when power is off, damage to the LMC7211 may occur. Large value (100 kΩ to MΩ) input resistors may reduce the likelihood of damage by limiting the input currents. Since the LMC7211 has very low input leakage currents, the effect on accuracy will be small. Additional protection may require the use of diodes, as shown in Figure 9. Note that diode leakage current may affect accuracy during normal operation. The R-C time constant of R_{IN} and the diode capacitance may also slow response time.

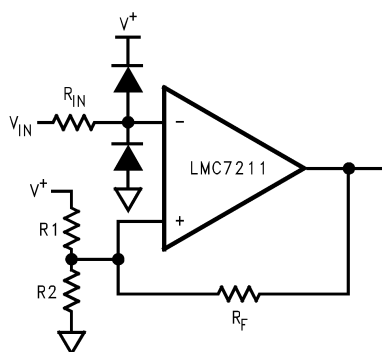

Figure 9.

Layout Considerations

The LMC7211 is not an especially fast comparator, so high speed design practices are not required. The LMC7211 is capable of operating with very high impedance inputs, so precautions should be taken to reduce noise pickup with high impedance (~ 100 kΩ and greater) designs and in electrically noisy environments.

Keeping high value resistors close to the LMC7211 and minimizing the size of the input nodes is a good practice. With multilayer designs, try to avoid long loops which could act as inductors (coils). Sensors which are not close to the comparator may need twisted pair or shielded connections to reduce noise.

Open Drain Output, Dual Versions

The LMC7221 is a comparator similar to the LMC7211, but with an open drain output which allows the output voltage to be different (higher or lower) than the supply voltage. The open drain output is like the open collector output of a logic gate. This makes the LMC7221 very useful for mixed voltage systems. Many systems will have different voltages for the analog and microprocessor sections. Please see the LMC7221 datasheet for details.

The performance of the LMC7211 is available in dual devices. Please see the LMC6762 datasheet for details on a dual push-pull output device. For a dual device with open drain outputs, please see the LMC6772 datasheet.

Rail-to-Rail Input Low Power Comparators—

Push-Pull Output		
LMC7211	SOT23-5, SO-8	Single
LMC6762	SO-8,	Dual

Open Drain Output		
LMC7221	SOT23-5, SO-8	Single
LMC6772	SO-8, DIP	Dual

Additional SOT23-5 Tiny Devices

National Semiconductor has additional parts available in the space saving SOT23 Tiny package, including amplifiers, voltage references, and voltage regulators. These devices include—

LMC7101 1 MHz gain-bandwidth rail-to-rail input and output amplifier—high input impedance and high gain 700 μ A typical current 2.7V, 3V, 5V and 15V specifications.

LMC7111 Low power 50 kHz gain-bandwidth rail-to-rail input and output amplifier with 25 μ A typical current specified at 2.7V, 3.0V, 3.3V, 5V and 10V.

LM7131 Tiny Video amp with 70 MHz gain bandwidth 3V, 5V and \pm 5V specifications.

LP2980 Micropower SOT 50 mA Ultra Low-Dropout Regulator.

LM4040 Precision micropower shunt voltage reference. Fixed voltages of 2.500V, 4.096V, 5.000V, 8.192V and 10.000V.

LM4041 Precision micropower shut voltage reference 1.225V and adjustable.

LM385 Low current voltage reference. Fixed Voltages of 1.2V and 2.5V.

Contact your National Semiconductor representative for the latest information.

Spice Macromodel

A Spice Macromodel is available for the LMC7211 comparator on the National Semiconductor Amplifier Macromodel disk. Contact your National Semiconductor representative to obtain the latest version.

PACKAGING INFORMATION

Orderable Device	Status (1)	Package Type	Package Drawing	Pins	Package Qty	Eco Plan (2)	Lead/Ball Finish (6)	MSL Peak Temp (3)	Op Temp (°C)	Device Marking (4/5)	Samples
LMC7211AIM	NRND	SOIC	D	8	95	TBD	Call TI	Call TI	-40 to 85	LMC72 11AIM	
LMC7211AIM/NOPB	ACTIVE	SOIC	D	8	95	Green (RoHS & no Sb/Br)	CU SN	Level-1-260C-UNLIM	-40 to 85	LMC72 11AIM	Samples
LMC7211AIM5	NRND	SOT-23	DBV	5	1000	TBD	Call TI	Call TI	-40 to 85	C00A	
LMC7211AIM5/NOPB	ACTIVE	SOT-23	DBV	5	1000	Green (RoHS & no Sb/Br)	CU SN	Level-1-260C-UNLIM	-40 to 85	C00A	Samples
LMC7211AIM5X	NRND	SOT-23	DBV	5	3000	TBD	Call TI	Call TI	-40 to 85	C00A	
LMC7211AIM5X/NOPB	ACTIVE	SOT-23	DBV	5	3000	Green (RoHS & no Sb/Br)	CU SN	Level-1-260C-UNLIM	-40 to 85	C00A	Samples
LMC7211AIMX/NOPB	ACTIVE	SOIC	D	8	2500	Green (RoHS & no Sb/Br)	CU SN	Level-1-260C-UNLIM	-40 to 85	LMC72 11AIM	Samples
LMC7211BIM	NRND	SOIC	D	8	95	TBD	Call TI	Call TI	-40 to 85	LMC72 11BIM	
LMC7211BIM/NOPB	ACTIVE	SOIC	D	8	95	Green (RoHS & no Sb/Br)	CU SN	Level-1-260C-UNLIM	-40 to 85	LMC72 11BIM	Samples
LMC7211BIM5	NRND	SOT-23	DBV	5	1000	TBD	Call TI	Call TI	-40 to 85	C00B	
LMC7211BIM5/NOPB	ACTIVE	SOT-23	DBV	5	1000	Green (RoHS & no Sb/Br)	CU SN	Level-1-260C-UNLIM	-40 to 85	C00B	Samples
LMC7211BIM5X	NRND	SOT-23	DBV	5	3000	TBD	Call TI	Call TI	-40 to 85	C00B	
LMC7211BIM5X/NOPB	ACTIVE	SOT-23	DBV	5	3000	Green (RoHS & no Sb/Br)	CU SN	Level-1-260C-UNLIM	-40 to 85	C00B	Samples
LMC7211BIMX/NOPB	ACTIVE	SOIC	D	8	2500	Green (RoHS & no Sb/Br)	CU SN	Level-1-260C-UNLIM	-40 to 85	LMC72 11BIM	Samples

(1) The marketing status values are defined as follows:

ACTIVE: Product device recommended for new designs.

LIFEBUY: TI has announced that the device will be discontinued, and a lifetime-buy period is in effect.

NRND: Not recommended for new designs. Device is in production to support existing customers, but TI does not recommend using this part in a new design.

PREVIEW: Device has been announced but is not in production. Samples may or may not be available.

OBSOLETE: TI has discontinued the production of the device.

(2) Eco Plan - The planned eco-friendly classification: Pb-Free (RoHS), Pb-Free (RoHS Exempt), or Green (RoHS & no Sb/Br) - please check <http://www.ti.com/productcontent> for the latest availability information and additional product content details.

TBD: The Pb-Free/Green conversion plan has not been defined.

Pb-Free (RoHS): TI's terms "Lead-Free" or "Pb-Free" mean semiconductor products that are compatible with the current RoHS requirements for all 6 substances, including the requirement that lead not exceed 0.1% by weight in homogeneous materials. Where designed to be soldered at high temperatures, TI Pb-Free products are suitable for use in specified lead-free processes.

Pb-Free (RoHS Exempt): This component has a RoHS exemption for either 1) lead-based flip-chip solder bumps used between the die and package, or 2) lead-based die adhesive used between the die and leadframe. The component is otherwise considered Pb-Free (RoHS compatible) as defined above.

Green (RoHS & no Sb/Br): TI defines "Green" to mean Pb-Free (RoHS compatible), and free of Bromine (Br) and Antimony (Sb) based flame retardants (Br or Sb do not exceed 0.1% by weight in homogeneous material)

⁽³⁾ MSL, Peak Temp. - The Moisture Sensitivity Level rating according to the JEDEC industry standard classifications, and peak solder temperature.

⁽⁴⁾ There may be additional marking, which relates to the logo, the lot trace code information, or the environmental category on the device.

⁽⁵⁾ Multiple Device Markings will be inside parentheses. Only one Device Marking contained in parentheses and separated by a "~" will appear on a device. If a line is indented then it is a continuation of the previous line and the two combined represent the entire Device Marking for that device.

⁽⁶⁾ Lead/Ball Finish - Orderable Devices may have multiple material finish options. Finish options are separated by a vertical ruled line. Lead/Ball Finish values may wrap to two lines if the finish value exceeds the maximum column width.

Important Information and Disclaimer:The information provided on this page represents TI's knowledge and belief as of the date that it is provided. TI bases its knowledge and belief on information provided by third parties, and makes no representation or warranty as to the accuracy of such information. Efforts are underway to better integrate information from third parties. TI has taken and continues to take reasonable steps to provide representative and accurate information but may not have conducted destructive testing or chemical analysis on incoming materials and chemicals. TI and TI suppliers consider certain information to be proprietary, and thus CAS numbers and other limited information may not be available for release.

In no event shall TI's liability arising out of such information exceed the total purchase price of the TI part(s) at issue in this document sold by TI to Customer on an annual basis.

TAPE AND REEL INFORMATION

QUADRANT ASSIGNMENTS FOR PIN 1 ORIENTATION IN TAPE

*All dimensions are nominal

Device	Package Type	Package Drawing	Pins	SPQ	Reel Diameter (mm)	Reel Width W1 (mm)	A0 (mm)	B0 (mm)	K0 (mm)	P1 (mm)	W (mm)	Pin1 Quadrant
LMC7211AIM5	SOT-23	DBV	5	1000	178.0	8.4	3.2	3.2	1.4	4.0	8.0	Q3
LMC7211AIM5/NOPB	SOT-23	DBV	5	1000	178.0	8.4	3.2	3.2	1.4	4.0	8.0	Q3
LMC7211AIM5X	SOT-23	DBV	5	3000	178.0	8.4	3.2	3.2	1.4	4.0	8.0	Q3
LMC7211AIM5X/NOPB	SOT-23	DBV	5	3000	178.0	8.4	3.2	3.2	1.4	4.0	8.0	Q3
LMC7211AIMX/NOPB	SOIC	D	8	2500	330.0	12.4	6.5	5.4	2.0	8.0	12.0	Q1
LMC7211BIM5	SOT-23	DBV	5	1000	178.0	8.4	3.2	3.2	1.4	4.0	8.0	Q3
LMC7211BIM5/NOPB	SOT-23	DBV	5	1000	178.0	8.4	3.2	3.2	1.4	4.0	8.0	Q3
LMC7211BIM5X	SOT-23	DBV	5	3000	178.0	8.4	3.2	3.2	1.4	4.0	8.0	Q3
LMC7211BIM5X/NOPB	SOT-23	DBV	5	3000	178.0	8.4	3.2	3.2	1.4	4.0	8.0	Q3
LMC7211BIMX/NOPB	SOIC	D	8	2500	330.0	12.4	6.5	5.4	2.0	8.0	12.0	Q1

TAPE AND REEL BOX DIMENSIONS

*All dimensions are nominal

Device	Package Type	Package Drawing	Pins	SPQ	Length (mm)	Width (mm)	Height (mm)
LMC7211AIM5	SOT-23	DBV	5	1000	210.0	185.0	35.0
LMC7211AIM5/NOPB	SOT-23	DBV	5	1000	210.0	185.0	35.0
LMC7211AIM5X	SOT-23	DBV	5	3000	210.0	185.0	35.0
LMC7211AIM5X/NOPB	SOT-23	DBV	5	3000	210.0	185.0	35.0
LMC7211AIMX/NOPB	SOIC	D	8	2500	367.0	367.0	35.0
LMC7211BIM5	SOT-23	DBV	5	1000	210.0	185.0	35.0
LMC7211BIM5/NOPB	SOT-23	DBV	5	1000	210.0	185.0	35.0
LMC7211BIM5X	SOT-23	DBV	5	3000	210.0	185.0	35.0
LMC7211BIM5X/NOPB	SOT-23	DBV	5	3000	210.0	185.0	35.0
LMC7211BIMX/NOPB	SOIC	D	8	2500	367.0	367.0	35.0



D0008A

PACKAGE OUTLINE

SOIC - 1.75 mm max height

SMALL OUTLINE INTEGRATED CIRCUIT



4214825/C 02/2019

NOTES:

- Linear dimensions are in inches [millimeters]. Dimensions in parenthesis are for reference only. Controlling dimensions are in inches. Dimensioning and tolerancing per ASME Y14.5M.
- This drawing is subject to change without notice.
- This dimension does not include mold flash, protrusions, or gate burrs. Mold flash, protrusions, or gate burrs shall not exceed $.006$ [0.15] per side.
- This dimension does not include interlead flash.
- Reference JEDEC registration MS-012, variation AA.

EXAMPLE BOARD LAYOUT

D0008A

SOIC - 1.75 mm max height

SMALL OUTLINE INTEGRATED CIRCUIT



LAND PATTERN EXAMPLE
 EXPOSED METAL SHOWN
 SCALE:8X



SOLDER MASK DETAILS

4214825/C 02/2019

NOTES: (continued)

- 6. Publication IPC-7351 may have alternate designs.
- 7. Solder mask tolerances between and around signal pads can vary based on board fabrication site.

EXAMPLE STENCIL DESIGN

D0008A

SOIC - 1.75 mm max height

SMALL OUTLINE INTEGRATED CIRCUIT



SOLDER PASTE EXAMPLE
BASED ON .005 INCH [0.125 MM] THICK STENCIL
SCALE:8X

4214825/C 02/2019

NOTES: (continued)

8. Laser cutting apertures with trapezoidal walls and rounded corners may offer better paste release. IPC-7525 may have alternate design recommendations.
9. Board assembly site may have different recommendations for stencil design.

EXAMPLE BOARD LAYOUT

DBV0005A

SOT-23 - 1.45 mm max height

SMALL OUTLINE TRANSISTOR



LAND PATTERN EXAMPLE
EXPOSED METAL SHOWN
SCALE:15X



SOLDER MASK DETAILS

4214839/D 11/2018

NOTES: (continued)

- Publication IPC-7351 may have alternate designs.
- Solder mask tolerances between and around signal pads can vary based on board fabrication site.

EXAMPLE STENCIL DESIGN

DBV0005A

SOT-23 - 1.45 mm max height

SMALL OUTLINE TRANSISTOR



SOLDER PASTE EXAMPLE
BASED ON 0.125 mm THICK STENCIL
SCALE:15X

4214839/D 11/2018

NOTES: (continued)

7. Laser cutting apertures with trapezoidal walls and rounded corners may offer better paste release. IPC-7525 may have alternate design recommendations.
8. Board assembly site may have different recommendations for stencil design.

IMPORTANT NOTICE AND DISCLAIMER

TI PROVIDES TECHNICAL AND RELIABILITY DATA (INCLUDING DATASHEETS), DESIGN RESOURCES (INCLUDING REFERENCE DESIGNS), APPLICATION OR OTHER DESIGN ADVICE, WEB TOOLS, SAFETY INFORMATION, AND OTHER RESOURCES "AS IS" AND WITH ALL FAULTS, AND DISCLAIMS ALL WARRANTIES, EXPRESS AND IMPLIED, INCLUDING WITHOUT LIMITATION ANY IMPLIED WARRANTIES OF MERCHANTABILITY, FITNESS FOR A PARTICULAR PURPOSE OR NON-INFRINGEMENT OF THIRD PARTY INTELLECTUAL PROPERTY RIGHTS.

These resources are intended for skilled developers designing with TI products. You are solely responsible for (1) selecting the appropriate TI products for your application, (2) designing, validating and testing your application, and (3) ensuring your application meets applicable standards, and any other safety, security, or other requirements. These resources are subject to change without notice. TI grants you permission to use these resources only for development of an application that uses the TI products described in the resource. Other reproduction and display of these resources is prohibited. No license is granted to any other TI intellectual property right or to any third party intellectual property right. TI disclaims responsibility for, and you will fully indemnify TI and its representatives against, any claims, damages, costs, losses, and liabilities arising out of your use of these resources.

TI's products are provided subject to TI's Terms of Sale (www.ti.com/legal/termsofsale.html) or other applicable terms available either on ti.com or provided in conjunction with such TI products. TI's provision of these resources does not expand or otherwise alter TI's applicable warranties or warranty disclaimers for TI products.

Mailing Address: Texas Instruments, Post Office Box 655303, Dallas, Texas 75265
Copyright © 2019, Texas Instruments Incorporated

Looking for pricing, stock, or lifecycle information?

Click below to explore more details on WIN SOURCE:

 [View LMC7211AIM5X/NOPB on WIN SOURCE](#)

 [Texas Instruments](#) Information

Optimize Your Supply Chain with WIN SOURCE Solutions

-  Global Sourcing Solution
-  Obsolete Management
-  Cost Control Management
-  Shortage Management
-  Alternative Solution
-  Excess Inventory Management