



# THE DATASHEET OF LMC6762AIM



# LMC6762 Dual MicroPower Rail-To-Rail Input CMOS Comparator with Push-Pull Output

Check for Samples: [LMC6762](#)

## FEATURES

- (Typical Unless Otherwise Noted)
- **Low Power Consumption (Max):**  $I_S = 10 \mu\text{A}/\text{comp}$
- **Wide Range of Supply Voltages:** 2.7V to 15V
- **Rail-To-Rail Input Common Mode Voltage Range**
- **Rail-To-Rail Output Swing (Within 100 mV of the Supplies, @  $V^+ = 2.7\text{V}$ , and  $I_{\text{LOAD}} = 2.5 \text{ mA}$ )**
- **Short Circuit Protection:** 40 mA
- **Propagation Delay (@  $V^+ = 5\text{V}$ , 100 mV Overdrive):** 4  $\mu\text{s}$

## APPLICATIONS

- Laptop Computers
- Mobile Phones
- Metering Systems
- Hand-Held Electronics
- RC Timers
- Alarm and Monitoring Circuits
- Window Comparators, Multivibrators

## Connection Diagram

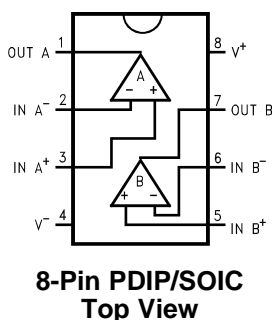

## DESCRIPTION

The LMC6762 is an ultra low power dual comparator with a maximum supply current of 10  $\mu\text{A}/\text{comparator}$ . It is designed to operate over a wide range of supply voltages, from 2.7V to 15V. The LMC6762 has ensured specifications at 2.7V to meet the demands of 3V digital systems.

The LMC6762 has an input common-mode voltage range which exceeds both supplies. This is a significant advantage in low-voltage applications. The LMC6762 also features a push-pull output that allows direct connections to logic devices without a pull-up resistor.

A quiescent power consumption of 50  $\mu\text{W}/\text{amplifier}$  (@  $V^+ = 5\text{V}$ ) makes the LMC6762 ideal for applications in portable phones and hand-held electronics. The ultra-low supply current is also independent of power supply voltage. Ensured operation at 2.7V and a rail-to-rail performance makes this device ideal for battery-powered applications.

Refer to the LMC6772 datasheet for an open-drain version of this device.

## Typical Application

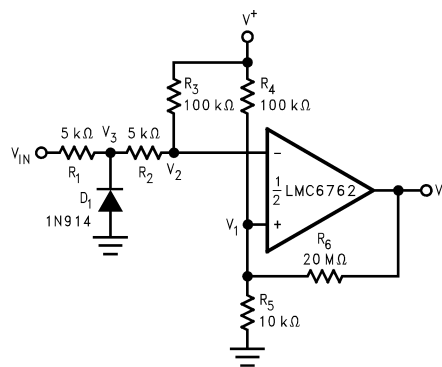
**Zero Crossing Detector**

These devices have limited built-in ESD protection. The leads should be shorted together or the device placed in conductive foam during storage or handling to prevent electrostatic damage to the MOS gates.



Please be aware that an important notice concerning availability, standard warranty, and use in critical applications of Texas Instruments semiconductor products and disclaimers thereto appears at the end of this data sheet.

All trademarks are the property of their respective owners.

## Absolute Maximum Ratings<sup>(1)(2)</sup>

ESD Tolerance <sup>(3)</sup>	2 kV
Differential Input Voltage	(V <sup>+</sup> )+0.3V to (V <sup>-</sup> )-0.3V
Voltage at Input/Output Pin	(V <sup>+</sup> )+0.3V to (V <sup>-</sup> )-0.3V
Supply Voltage (V <sup>+</sup> -V <sup>-</sup> )	16V
Current at Input Pin	±5 mA
Current at Output Pin <sup>(4)(5)</sup>	±30 mA
Current at Power Supply Pin, LMC6762	40 mA
Lead Temperature (Soldering, 10 seconds)	260°C
Storage Temperature Range	-65°C to +150°C
Junction Temperature <sup>(6)</sup>	150°C

- (1) Absolute Maximum Ratings indicate limits beyond which damage to the device may occur. Operating Ratings indicate conditions for which the device is intended to be functional, but specific performance is not ensured. For ensured specifications and the test conditions, see the electrical characteristics.
- (2) If Military/Aerospace specified devices are required, please contact the TI Sales Office/ Distributors for availability and specifications.
- (3) Human body model, 1.5 kΩ in series with 100 pF.
- (4) Do not short circuit output to V<sup>+</sup>, when V<sup>+</sup> is greater than 12V or reliability will be adversely affected.
- (5) Applies to both single-supply and split-supply operation. Continuous short circuit operation at elevated ambient temperature can result in exceeding the maximum allowed junction temperature of 150°C. Output currents in excess of ±30 mA over long term may adversely affect reliability.
- (6) The maximum power dissipation is a function of T<sub>J(max)</sub>, θ<sub>JA</sub>, and T<sub>A</sub>. The maximum allowable power dissipation at any ambient temperature is P<sub>D</sub> = (T<sub>J(max)</sub> - T<sub>A</sub>)/θ<sub>JA</sub>. All numbers apply for packages soldered directly into a PC board.

## Operating Ratings<sup>(1)</sup>

Supply Voltage	2.7 ≤ V <sub>S</sub> ≤ 15V	
Junction Temperature Range	LMC6762AI, LMC6762BI	-40°C ≤ T <sub>J</sub> ≤ +85°C
Thermal Resistance (θ <sub>JA</sub> )	P0008E Package, 8-Pin PDIP	100°C/W
	D0008A Package, 8-Pin SOIC	172°C/W

- (1) Absolute Maximum Ratings indicate limits beyond which damage to the device may occur. Operating Ratings indicate conditions for which the device is intended to be functional, but specific performance is not ensured. For ensured specifications and the test conditions, see the electrical characteristics.

## 2.7V Electrical Characteristics

Unless otherwise specified, all limits ensured for T<sub>J</sub> = 25°C, V<sup>+</sup> = 2.7V, V<sup>-</sup> = 0V, V<sub>CM</sub> = V<sup>+</sup>/2. **Boldface** limits apply at the temperature extremes.

Symbol	Parameter	Conditions	Typ <sup>(1)</sup>	LMC6762AI Limit <sup>(2)</sup>	LMC6762BI Limit <sup>(2)</sup>	Units
V <sub>OS</sub>	Input Offset Voltage		3	5	15	mV
				<b>8</b>	<b>18</b>	max
TCV <sub>OS</sub>	Input Offset Voltage Temperature Drift		2.0			μV/°C
	Input Offset Voltage Average Drift	See <sup>(3)</sup>	3.3			μV/Month
I <sub>B</sub>	Input Current		0.02			pA
I <sub>OS</sub>	Input Offset Current		0.01			pA
CMRR	Common Mode Rejection Ratio		75			dB
PSRR	Power Supply Rejection Ratio	±1.35V < V <sub>S</sub> < ±7.5V	80			dB
A <sub>V</sub>	Voltage Gain	(By Design)	100			dB

- (1) Typical Values represent the most likely parametric norm.
- (2) All limits are specified by testing or statistical analysis.
- (3) Input Offset Voltage Average Drift is calculated by dividing the accelerated operating life drift average by the equivalent operational time. The Input Offset Voltage Average Drift represents the input offset voltage change at worst-case input conditions.

## 2.7V Electrical Characteristics (continued)

Unless otherwise specified, all limits ensured for  $T_J = 25^\circ\text{C}$ ,  $V^+ = 2.7\text{V}$ ,  $V^- = 0\text{V}$ ,  $V_{\text{CM}} = V^+/2$ . **Boldface** limits apply at the temperature extremes.

Symbol	Parameter	Conditions	Typ <sup>(1)</sup>	LMC6762AI Limit <sup>(2)</sup>	LMC6762BI Limit <sup>(2)</sup>	Units
$V_{\text{CM}}$	Input Common-Mode Voltage Range	CMRR > 55 dB	3.0	2.9 <b>2.7</b>	2.9 <b>2.7</b>	V min
			-0.3	-0.2 <b>0.0</b>	-0.2 <b>0.0</b>	V max
$V_{\text{OH}}$	Output Voltage High	$I_{\text{LOAD}} = 2.5\text{ mA}$	2.5	2.4 <b>2.3</b>	2.4 <b>2.3</b>	V min
$V_{\text{OL}}$	Output Voltage Low	$I_{\text{LOAD}} = 2.5\text{ mA}$	0.2	0.3 <b>0.4</b>	0.3 <b>0.4</b>	V max
$I_{\text{S}}$	Supply Current	For Both Comparators (Output Low)	12	20 <b>25</b>	20 <b>25</b>	$\mu\text{A}$ max

## 5.0V and 15.0V Electrical Characteristics

Unless otherwise specified, all limits ensured for  $T_J = 25^\circ\text{C}$ ,  $V^+ = 5.0\text{V}$  and  $15.0\text{V}$ ,  $V^- = 0\text{V}$ ,  $V_{\text{CM}} = V^+/2$ . **Boldface** limits apply at the temperature extremes.

Symbol	Parameter	Conditions	Typ <sup>(1)</sup>	LMC6762AI Limit <sup>(2)</sup>	LMC6762BI Limit <sup>(1)</sup>	Units	
$V_{\text{OS}}$	Input Offset Voltage		3	5 <b>8</b>	15 <b>18</b>	mV max	
$\text{TCV}_{\text{OS}}$	Input Offset Voltage	$V^+ = 5\text{V}$	2.0			$\mu\text{V}/^\circ\text{C}$	
	Temperature Drift	$V^+ = 15\text{V}$	4.0				
	Input Offset Voltage	$V^+ = 5\text{V}^{(3)}$	3.3			$\mu\text{V}/\text{Month}$	
	Average Drift	$V^+ = 15\text{V}^{(3)}$	4.0				
$I_{\text{B}}$	Input Current	$V = 5\text{V}$	0.04			pA	
$I_{\text{OS}}$	Input Offset Current	$V^+ = 5\text{V}$	0.02			pA	
CMRR	Common Mode	$V^+ = 5\text{V}$	75			dB	
	Rejection Ratio	$V^+ = 15\text{V}$	82			dB	
PSRR	Power Supply Rejection Ratio	$\pm 2.5\text{V} < V_{\text{S}} < \pm 5\text{V}$	80			dB	
$A_{\text{V}}$	Voltage Gain	(By Design)	100			dB	
$V_{\text{CM}}$	Input Common-Mode Voltage Range	$V^+ = 5.0\text{V}$ CMRR > 55 dB	5.3	5.2 <b>5.0</b>	5.2 <b>5.0</b>	V min	
			-0.3	-0.2 <b>0.0</b>	-0.2 <b>0.0</b>	V max	
	$V^+ = 15.0\text{V}$ CMRR > 55 dB	15.3	15.2 <b>15.0</b>	15.2 <b>15.0</b>	V min		
		-0.3	-0.2 <b>0.0</b>	-0.2 <b>0.0</b>	V max		
	$V_{\text{OH}}$	Output Voltage High	$V^+ = 5\text{V}$ $I_{\text{LOAD}} = 5\text{mA}$	4.8	4.6 <b>4.45</b>	4.6 <b>4.45</b>	V min
			$V^+ = 15\text{V}$ $I_{\text{LOAD}} = 5\text{ mA}$	14.8	14.6 <b>14.45</b>	14.6 <b>14.45</b>	V min

(1) Typical Values represent the most likely parametric norm.

(2) All limits are specified by testing or statistical analysis.

(3) Input Offset Voltage Average Drift is calculated by dividing the accelerated operating life drift average by the equivalent operational time. The Input Offset Voltage Average Drift represents the input offset voltage change at worst-case input conditions.

## 5.0V and 15.0V Electrical Characteristics (continued)

Unless otherwise specified, all limits ensured for  $T_J = 25^\circ\text{C}$ ,  $V^+ = 5.0\text{V}$  and  $15.0\text{V}$ ,  $V^- = 0\text{V}$ ,  $V_{\text{CM}} = V^+/2$ . **Boldface** limits apply at the temperature extremes.

Symbol	Parameter	Conditions	Typ <sup>(1)</sup>	LMC6762AI Limit <sup>(2)</sup>	LMC6762BI Limit <sup>(1)</sup>	Units
$V_{\text{OL}}$	Output Voltage Low	$V^+ = 5\text{V}$ $I_{\text{LOAD}} = 5\text{ mA}$	0.2	0.4 <b>0.55</b>	0.4 <b>0.55</b>	V max
		$V^+ = 15\text{V}$ $I_{\text{LOAD}} = 5\text{ mA}$	0.2	0.4 <b>0.55</b>	0.4 <b>0.55</b>	V max
$I_{\text{S}}$	Supply Current	For Both Comparators (Output Low)	12	20 <b>25</b>	20 <b>25</b>	$\mu\text{A}$ max
$I_{\text{SC}}$	Short Circuit Current	Sourcing	30			mA
		Sinking, $V_{\text{O}} = 12\text{V}^{(4)}$	45			

(4) Do not short circuit output to  $V^+$ , when  $V^+$  is greater than 12V or reliability will be adversely affected.

## AC Electrical Characteristics

Unless otherwise specified, all limits ensured for  $T_J = 25^\circ\text{C}$ ,  $V^+ = 5\text{V}$ ,  $V^- = 0\text{V}$ ,  $V_{\text{CM}} = V_{\text{O}} = V^+/2$ . **Boldface** limits apply at the temperature extreme.

Symbol	Parameter	Conditions	Typ <sup>(1)</sup>	LMC6762AI Limit <sup>(2)</sup>	LMC6762BI Limit <sup>(2)</sup>	Units
$t_{\text{RISE}}$	Rise Time	$f = 10\text{ kHz}$ , $C_{\text{L}} = 50\text{ pF}$ , Overdrive = $10\text{ mV}^{(3)(4)}$	0.3			$\mu\text{s}$
$t_{\text{FALL}}$	Fall Time	$f = 10\text{ kHz}$ , $C_{\text{L}} = 50\text{ pF}$ , Overdrive = $10\text{ mV}^{(3)(4)}$	0.3			$\mu\text{s}$
$t_{\text{PHL}}$	Propagation Delay (High to Low)	$f = 10\text{ kHz}$ , $C_{\text{L}} = 50\text{ pF}^{(3)(4)}$	Overdrive = $10\text{ mV}$	10		$\mu\text{s}$
			Overdrive = $100\text{ mV}$	4		$\mu\text{s}$
		$V^+ = 2.7\text{V}$ , $f = 10\text{ kHz}$ , $C_{\text{L}} = 50\text{ pF}^{(3)(4)}$	Overdrive = $10\text{ mV}$	10		$\mu\text{s}$
			Overdrive = $100\text{ mV}$	4		$\mu\text{s}$
$t_{\text{PLH}}$	Propagation Delay (Low to High)	$f = 10\text{ kHz}$ , $C_{\text{L}} = 50\text{ pF}^{(3)(4)}$	Overdrive = $10\text{ mV}$	6		$\mu\text{s}$
			Overdrive = $100\text{ mV}$	4		$\mu\text{s}$
		$V^+ = 2.7\text{V}$ , $f = 10\text{ kHz}$ , $C_{\text{L}} = 50\text{ pF}^{(3)(4)}$	Overdrive = $10\text{ mV}$	7		$\mu\text{s}$
			Overdrive = $100\text{ mV}$	4		$\mu\text{s}$

(1) Typical Values represent the most likely parametric norm.

(2) All limits are specified by testing or statistical analysis.

(3)  $C_{\text{L}}$  includes the probe and jig capacitance.

(4) The rise and fall times are measured with a 2V input step. The propagation delays are also measured with a 2V input step.

### Typical Performance Characteristics

$V^+ = 5V$ , Single Supply,  $T_A = 25^\circ C$  unless otherwise specified

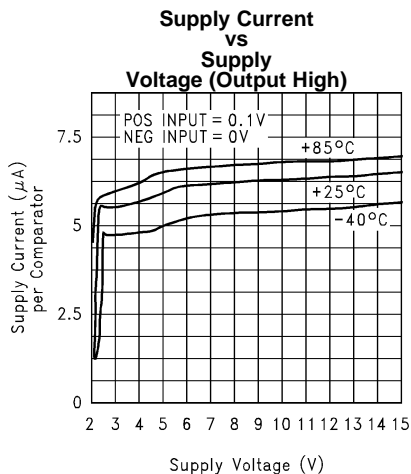

Figure 1.

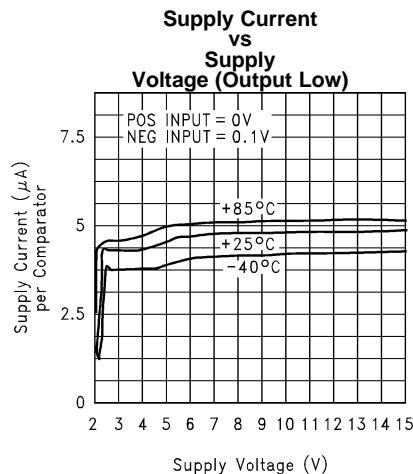

Figure 2.

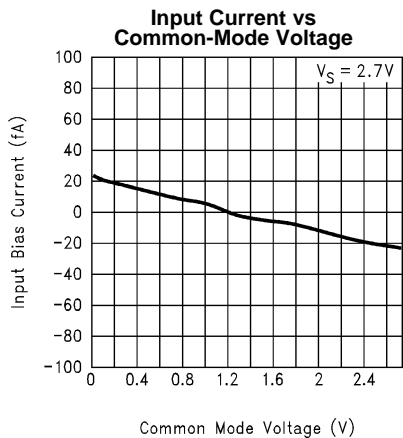

Figure 3.

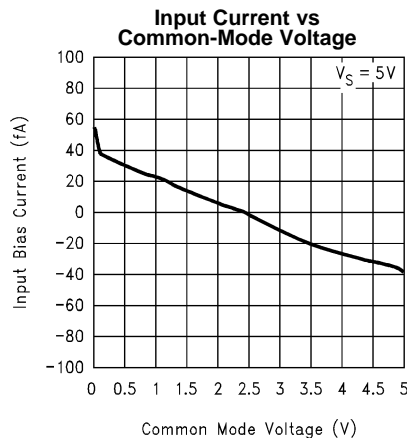

Figure 4.

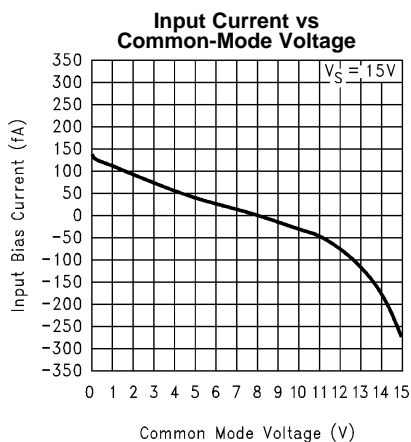

Figure 5.

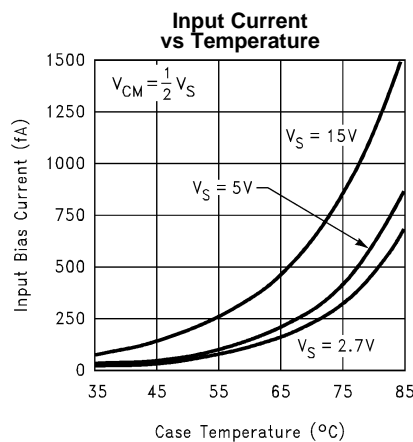
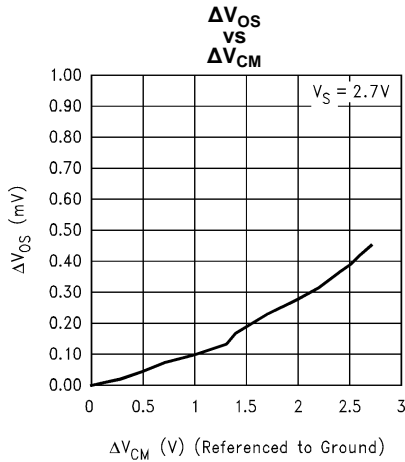

Figure 6.

**Typical Performance Characteristics (continued)**

V<sup>+</sup> = 5V, Single Supply, T<sub>A</sub> = 25°C unless otherwise specified



**Figure 7.**

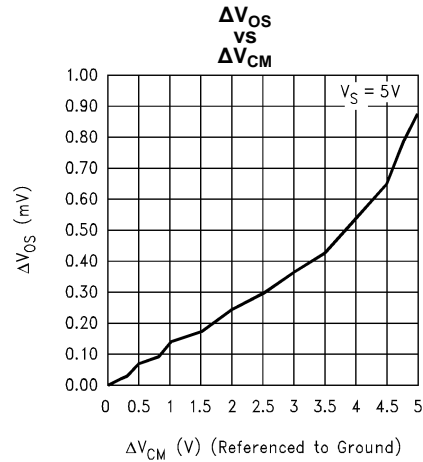

**Figure 8.**

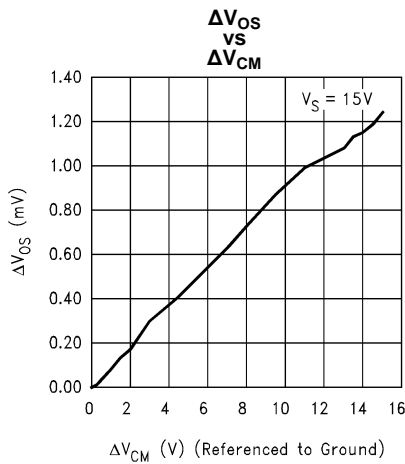

**Figure 9.**

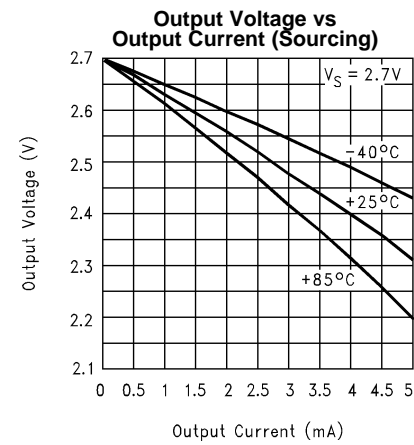

**Figure 10.**

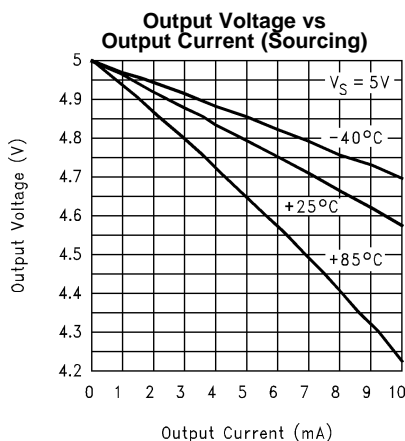

**Figure 11.**

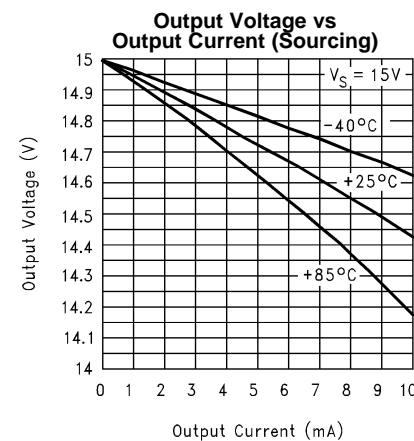

**Figure 12.**

Typical Performance Characteristics (continued)

$V^+ = 5V$ , Single Supply,  $T_A = 25^\circ C$  unless otherwise specified

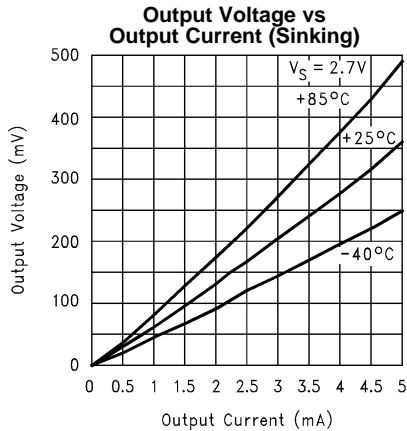

Figure 13.

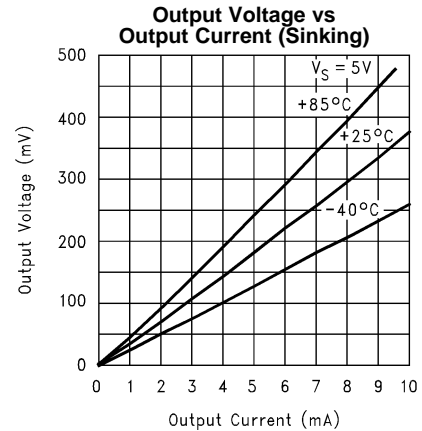

Figure 14.

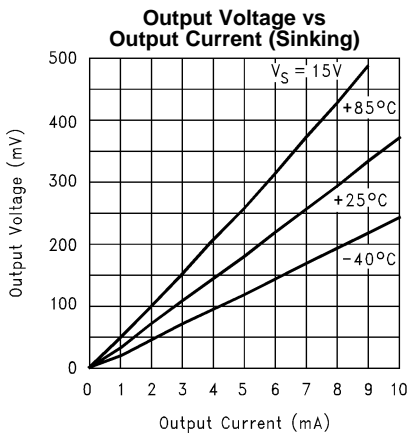

Figure 15.

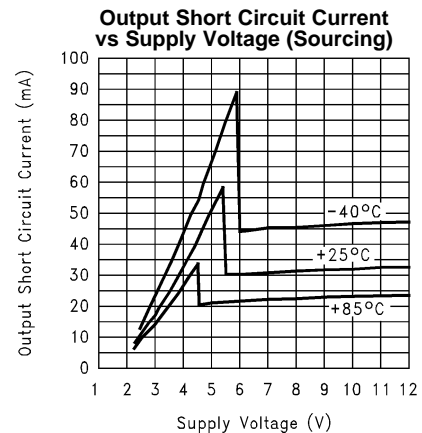

Figure 16.

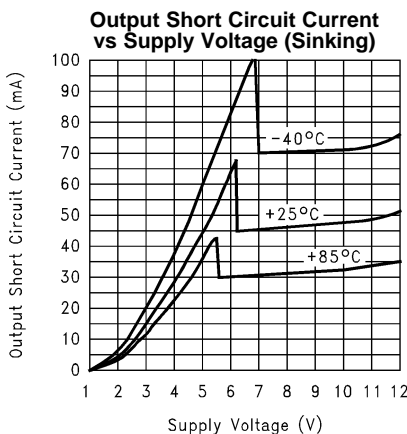

Figure 17.

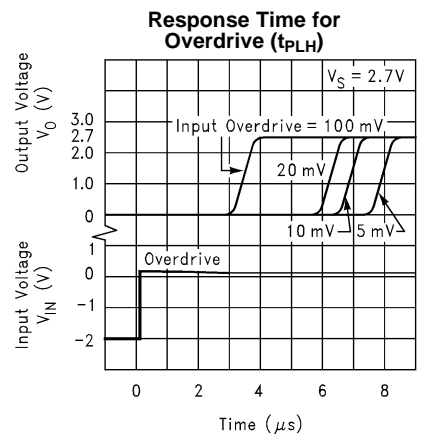
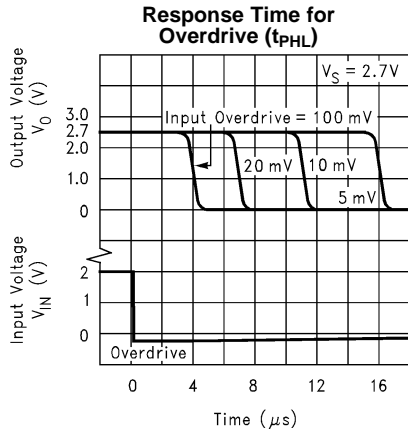

Figure 18.

**Typical Performance Characteristics (continued)**

$V^+ = 5V$ , Single Supply,  $T_A = 25^\circ C$  unless otherwise specified



**Figure 19.**

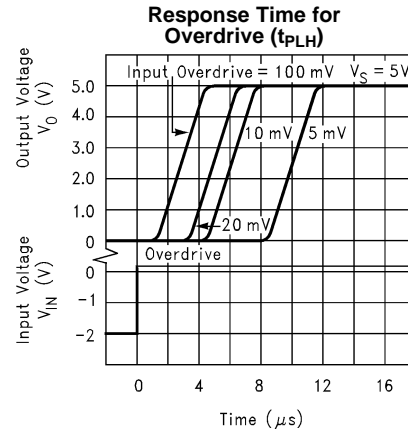

**Figure 20.**

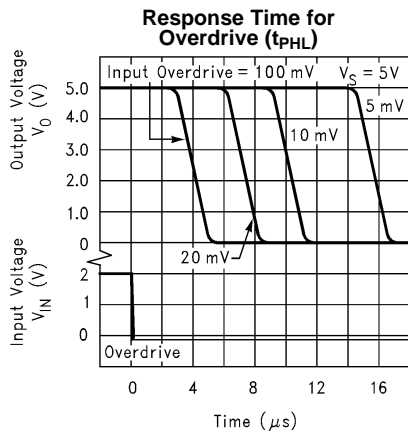

**Figure 21.**

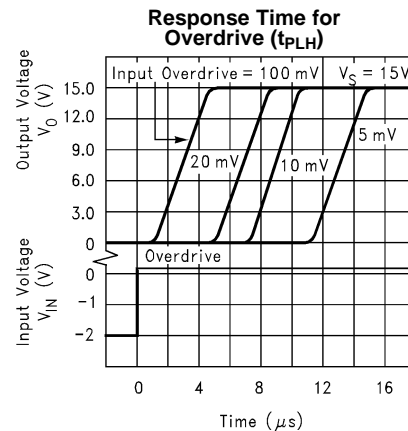

**Figure 22.**

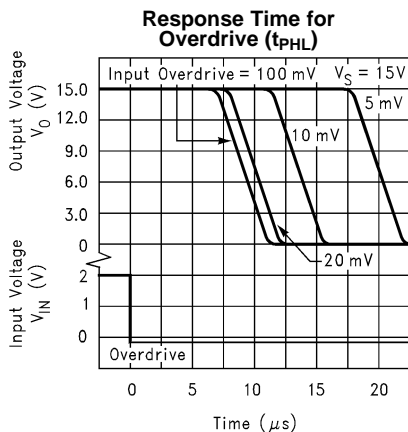

**Figure 23.**

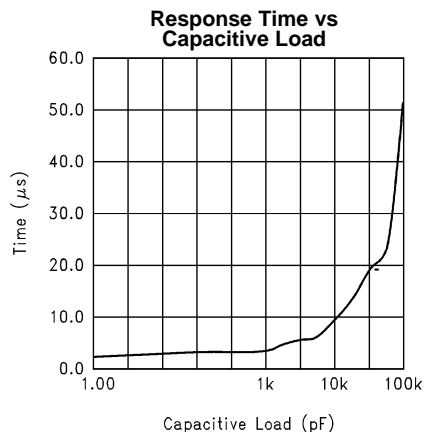
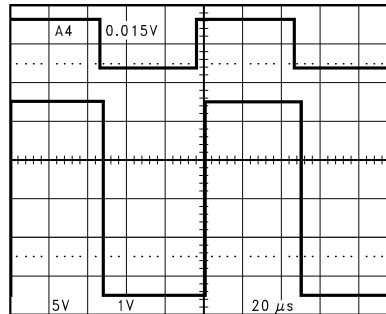

**Figure 24.**

## APPLICATION HINTS

### Input Common-Mode Voltage Range

At supply voltages of 2.7V, 5V and 15V, the LMC6762 has an input common-mode voltage range which exceeds both supplies. As in the case of operational amplifiers, CMVR is defined by the  $V_{OS}$  shift of the comparator over the common-mode range of the device. A CMRR ( $\Delta V_{OS}/\Delta V_{CM}$ ) of 75 dB (typical) implies a shift of < 1 mV over the entire common-mode range of the device. The absolute maximum input voltage at  $V^+ = 5V$  is 200 mV beyond either supply rail at room temperature.



**Figure 25. An Input Signal Exceeds the LMC6762 Power Supply Voltages with No Output Phase Inversion**

A wide input voltage range means that the comparator can be used to sense signals close to ground and also to the power supplies. This is an extremely useful feature in power supply monitoring circuits.

An input common-mode voltage range that exceeds the supplies, 20 fA input currents (typical), and a high input impedance makes the LMC6762 ideal for sensor applications. The LMC6762 can directly interface to sensors without the use of amplifiers or bias circuits. In circuits with sensors which produce outputs in the tens to hundreds of millivolts, the LMC6762 can compare the sensor signal with an appropriately small reference voltage. This reference voltage can be close to ground or the positive supply rail.

### Low Voltage Operation

Comparators are the common devices by which analog signals interface with digital circuits. The LMC6762 has been designed to operate at supply voltages of 2.7V without sacrificing performance to meet the demands of 3V digital systems.

At supply voltages of 2.7V, the common-mode voltage range extends 200 mV (ensured) below the negative supply. This feature, in addition to the comparator being able to sense signals near the positive rail, is extremely useful in low voltage applications.

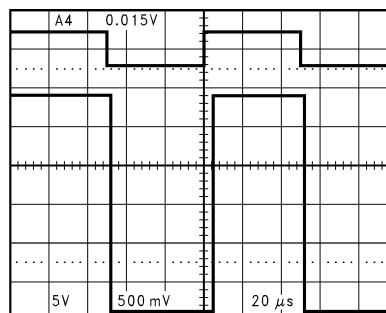

**Figure 26. Even at Low-Supply Voltage of 2.7V, an Input Signal which Exceeds the Supply Voltages Produces No Phase Inversion at the Output**

At  $V^+ = 2.7V$ , propagation delays are  $t_{PLH} = 4 \mu s$  and  $t_{PHL} = 4 \mu s$  with overdrives of 100 mV. Please refer to the [performance curves](#) for more extensive characterization.

### Shoot-Through Current

The shoot-through current is defined as the current surge, above the quiescent supply current, between the positive and negative supplies of a device. The current surge occurs when the output of the device switches states. This transient switching current results in glitches in the supply voltage. Usually, glitches in the supply lines are compensated by bypass capacitors. When the switching currents are minimal, the values of the bypass capacitors can be reduced considerably.

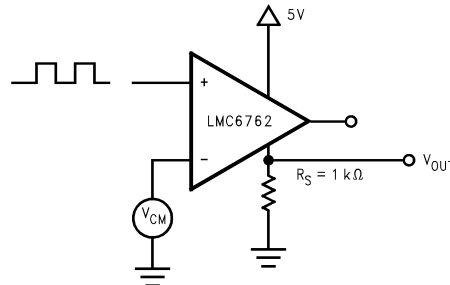

Figure 27. LMC6762 Circuit for Measurement of the Shoot-Through Current

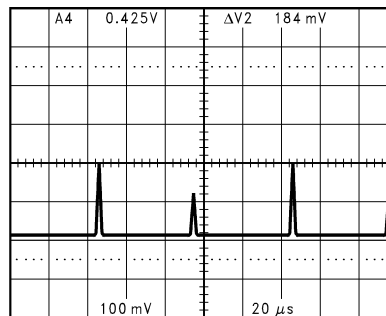
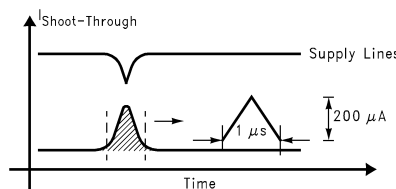

Figure 28. Measurement of the Shoot-Through Current

From Figure 27 and Figure 28 the shoot-through current for the LMC6762 can be approximated to be 0.2 mA (200 mV/1 kΩ). The duration of the transient is measured as 1 μs. The values needed for the local bypass capacitors can be calculated as follows:



$$\begin{aligned} \text{Area of } \Delta &= \frac{1}{2} (1 \mu\text{s} \times 200 \mu\text{A}) \\ &= 100 \text{ pC} \end{aligned}$$

If the local bypass capacitor has to provide this charge of 100 pC, the minimum value of the local capacitor to prevent local degradation of  $V_{CC}$  can be calculated. Suppose that the maximum voltage droop that the system can tolerate is 100mV,

$$\begin{aligned} \Delta Q &= C * (\Delta V) \\ \rightarrow C &= (\Delta Q / \Delta V) \\ &= 100 \text{ pC} / 100 \text{ mV} \\ &= 0.001 \mu\text{F} \end{aligned}$$

The low internal feedthrough current of the LMC6762 thus requires lower values for the local bypass capacitors. In applications where precision is not critical, this is a significant advantage, as lower values of capacitors result in savings of board space, and cost.

It is worth noting here that the delta shift of the power supply voltage due to the transient currents causes a threshold shift of the comparator. This threshold shift is reduced by the high PSRR of the comparator. However, the value of the PSRR applicable in this instance is the transient PSRR and not the DC PSRR. The transient PSRR is significantly lower than the DC PSRR.

Generally, it is a good goal to reduce the delta voltage on the power supply to a value equal to or less than the hysteresis of the comparator. For example, if the comparator has 50 mV of hysteresis, it would be reasonable to increase the value of the local bypass capacitor to 0.01  $\mu\text{F}$  to reduce the voltage delta to 10 mV.

### Output Short Circuit Current

The LMC6762 has short circuit protection of 40 mA. However, it is not designed to withstand continuous short circuits, transient voltage or current spikes, or shorts to any voltage beyond the supplies. A resistor in series with the output should reduce the effect of shorts. For outputs which send signals off PC boards additional protection devices, such as diodes to the supply rails, and varistors may be used.

### Hysteresis

If the input signal is very noisy, the comparator output might trip several times as the input signal repeatedly passes through the threshold. This problem can be addressed by making use of hysteresis as shown below.

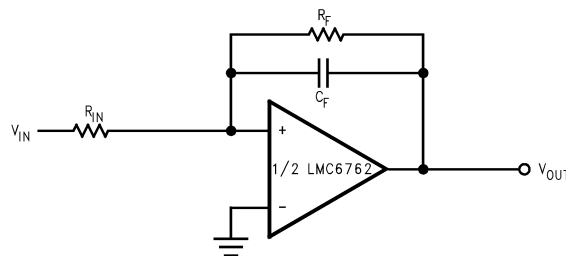

Figure 29. Canceling the Effect of Input Capacitance

The capacitor added across the feedback resistor increases the switching speed and provides more short term hysteresis. This can result in greater noise immunity for the circuit.

### Spice Macromodel

A Spice Macromodel is available for the LMC6762. The model includes a simulation of:

- Input common-mode voltage range
- Quiescent and dynamic supply current
- Input overdrive characteristics

and many more characteristics as listed on the macromodel disk.

A SPICE macromodel of this and many other op amps is available at no charge from the WEBENCH Design Center Team at <http://www.ti.com/ww/en/analog/webench/>

## Typical Applications

### One-Shot Multivibrator

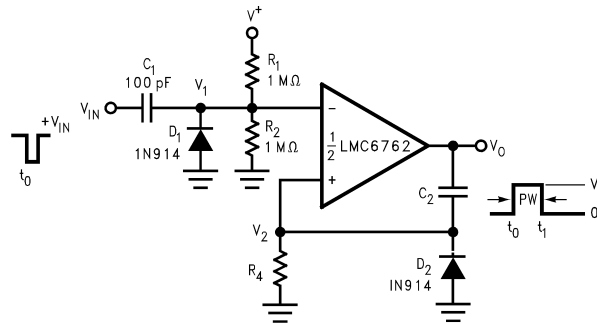
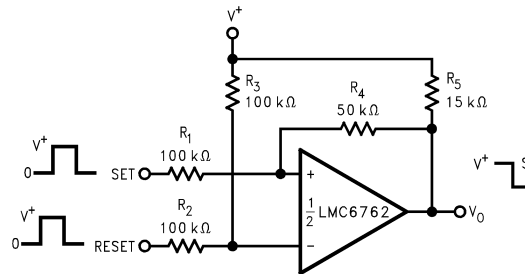

**Figure 30. One-Shot Multivibrator**

A monostable multivibrator has one stable state in which it can remain indefinitely. It can be triggered externally to another quasi-stable state. A monostable multivibrator can thus be used to generate a pulse of desired width.

The desired pulse width is set by adjusting the values of  $C_2$  and  $R_4$ . The resistor divider of  $R_1$  and  $R_2$  can be used to determine the magnitude of the input trigger pulse. The LMC6762 will change state when  $V_1 < V_2$ . Diode  $D_2$  provides a rapid discharge path for capacitor  $C_2$  to reset at the end of the pulse. The diode also prevents the non-inverting input from being driven below ground.

### Bi-Stable Multivibrator



**Figure 31. Bi-Stable Multivibrator**

A bi-stable multivibrator has two stable states. The reference voltage is set up by the voltage divider of  $R_2$  and  $R_3$ . A pulse applied to the SET terminal will switch the output of the comparator high. The resistor divider of  $R_1$ ,  $R_4$ , and  $R_5$  now clamps the non-inverting input to a voltage greater than the reference voltage. A pulse applied to RESET will now toggle the output low.

### Zero Crossing Detector

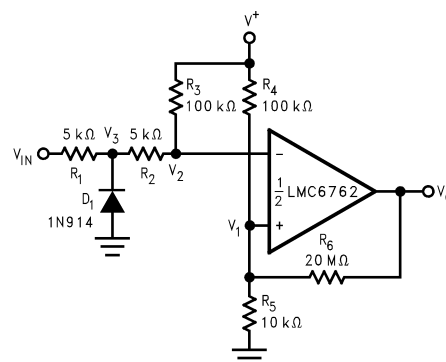

**Figure 32. Zero Crossing Detector**

A voltage divider of  $R_4$  and  $R_5$  establishes a reference voltage  $V_1$  at the non-inverting input. By making the series resistance of  $R_1$  and  $R_2$  equal to  $R_5$ , the comparator will switch when  $V_{IN} = 0$ . Diode  $D_1$  insures that  $V_3$  never drops below  $-0.7V$ . The voltage divider of  $R_2$  and  $R_3$  then prevents  $V_2$  from going below ground. A small amount of hysteresis is setup to ensure rapid output voltage transitions.

**Oscillator**

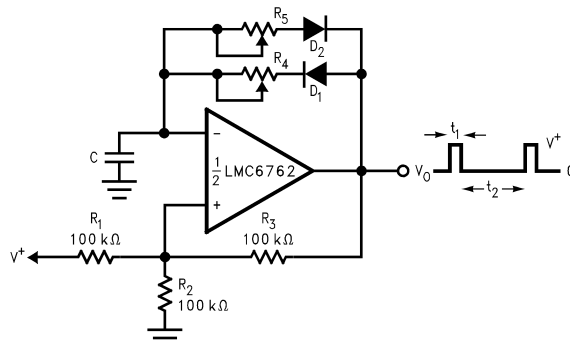

**Figure 33. Square Wave Generator**

Figure 33 shows the application of the LMC6762 in a square wave generator circuit. The total hysteresis of the loop is set by  $R_1$ ,  $R_2$  and  $R_3$ .  $R_4$  and  $R_5$  provide separate charge and discharge paths for the capacitor  $C$ . The charge path is set through  $R_4$  and  $D_1$ . So, the pulse width  $t_1$  is determined by the RC time constant of  $R_4$  and  $C$ . Similarly, the discharge path for the capacitor is set by  $R_5$  and  $D_2$ . Thus, the time  $t_2$  between the pulses can be changed by varying  $R_5$ , and the pulse width can be altered by  $R_4$ . The frequency of the output can be changed by varying both  $R_4$  and  $R_5$ .

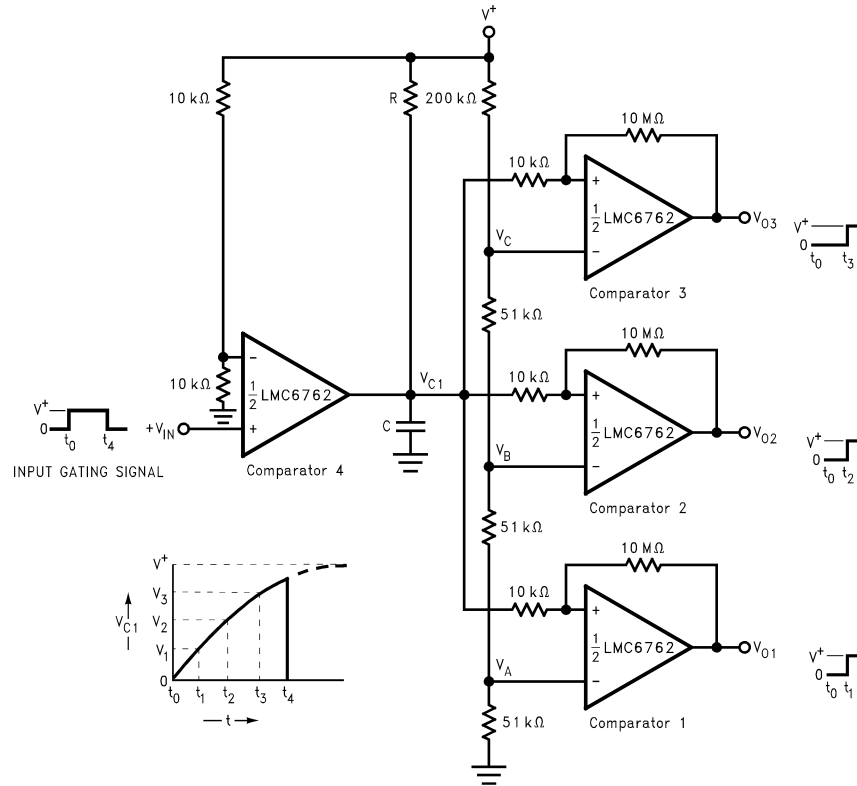

Figure 34. Time Delay Generator

The circuit shown above provides output signals at a prescribed time interval from a time reference and automatically resets the output when the input returns to ground. Consider the case of  $V_{IN} = 0$ . The output of comparator 4 is also at ground. This implies that the outputs of comparators 1, 2, and 3 are also at ground. When an input signal is applied, the output of comparator 4 swings high and  $C$  charges exponentially through  $R$ . This is indicated above.

The output voltages of comparators 1, 2, and 3 switch to the high state when  $V_{C1}$  rises above the reference voltage  $V_A$ ,  $V_B$  and  $V_C$ . A small amount of hysteresis has been provided to insure fast switching when the RC time constant is chosen to give long delay times.

---

**REVISION HISTORY**

<b>Changes from Revision C (March 2013) to Revision D</b>	<b>Page</b>
• Changed layout of National Data Sheet to TI format .....	<a href="#">14</a>

---

**PACKAGING INFORMATION**

Orderable Device	Status (1)	Package Type	Package Drawing	Pins	Package Qty	Eco Plan (2)	Lead/Ball Finish (6)	MSL Peak Temp (3)	Op Temp (°C)	Device Marking (4/5)	Samples
LMC6762AIM	NRND	SOIC	D	8	95	TBD	Call TI	Call TI	-40 to 85	LMC67 62AIM	
LMC6762AIM/NOPB	ACTIVE	SOIC	D	8	95	Green (RoHS & no Sb/Br)	CU SN	Level-1-260C-UNLIM	-40 to 85	LMC67 62AIM	<b>Samples</b>
LMC6762AIMX	NRND	SOIC	D	8	2500	TBD	Call TI	Call TI	-40 to 85	LMC67 62AIM	
LMC6762AIMX/NOPB	ACTIVE	SOIC	D	8	2500	Green (RoHS & no Sb/Br)	CU SN	Level-1-260C-UNLIM	-40 to 85	LMC67 62AIM	<b>Samples</b>
LMC6762BIM	NRND	SOIC	D	8	95	TBD	Call TI	Call TI	-40 to 85	LMC67 62BIM	
LMC6762BIM/NOPB	ACTIVE	SOIC	D	8	95	Green (RoHS & no Sb/Br)	CU SN	Level-1-260C-UNLIM	-40 to 85	LMC67 62BIM	<b>Samples</b>
LMC6762BIMX	NRND	SOIC	D	8	2500	TBD	Call TI	Call TI	-40 to 85	LMC67 62BIM	
LMC6762BIMX/NOPB	ACTIVE	SOIC	D	8	2500	Green (RoHS & no Sb/Br)	CU SN	Level-1-260C-UNLIM	-40 to 85	LMC67 62BIM	<b>Samples</b>

(1) The marketing status values are defined as follows:

**ACTIVE:** Product device recommended for new designs.

**LIFEBUY:** TI has announced that the device will be discontinued, and a lifetime-buy period is in effect.

**NRND:** Not recommended for new designs. Device is in production to support existing customers, but TI does not recommend using this part in a new design.

**PREVIEW:** Device has been announced but is not in production. Samples may or may not be available.

**OBSOLETE:** TI has discontinued the production of the device.

(2) Eco Plan - The planned eco-friendly classification: Pb-Free (RoHS), Pb-Free (RoHS Exempt), or Green (RoHS & no Sb/Br) - please check <http://www.ti.com/productcontent> for the latest availability information and additional product content details.

**TBD:** The Pb-Free/Green conversion plan has not been defined.

**Pb-Free (RoHS):** TI's terms "Lead-Free" or "Pb-Free" mean semiconductor products that are compatible with the current RoHS requirements for all 6 substances, including the requirement that lead not exceed 0.1% by weight in homogeneous materials. Where designed to be soldered at high temperatures, TI Pb-Free products are suitable for use in specified lead-free processes.

**Pb-Free (RoHS Exempt):** This component has a RoHS exemption for either 1) lead-based flip-chip solder bumps used between the die and package, or 2) lead-based die adhesive used between the die and leadframe. The component is otherwise considered Pb-Free (RoHS compatible) as defined above.

**Green (RoHS & no Sb/Br):** TI defines "Green" to mean Pb-Free (RoHS compatible), and free of Bromine (Br) and Antimony (Sb) based flame retardants (Br or Sb do not exceed 0.1% by weight in homogeneous material)

(3) MSL, Peak Temp. - The Moisture Sensitivity Level rating according to the JEDEC industry standard classifications, and peak solder temperature.

(4) There may be additional marking, which relates to the logo, the lot trace code information, or the environmental category on the device.

(5) Multiple Device Markings will be inside parentheses. Only one Device Marking contained in parentheses and separated by a "~" will appear on a device. If a line is indented then it is a continuation of the previous line and the two combined represent the entire Device Marking for that device.

(6) Lead/Ball Finish - Orderable Devices may have multiple material finish options. Finish options are separated by a vertical ruled line. Lead/Ball Finish values may wrap to two lines if the finish value exceeds the maximum column width.

**Important Information and Disclaimer:**The information provided on this page represents TI's knowledge and belief as of the date that it is provided. TI bases its knowledge and belief on information provided by third parties, and makes no representation or warranty as to the accuracy of such information. Efforts are underway to better integrate information from third parties. TI has taken and continues to take reasonable steps to provide representative and accurate information but may not have conducted destructive testing or chemical analysis on incoming materials and chemicals. TI and TI suppliers consider certain information to be proprietary, and thus CAS numbers and other limited information may not be available for release.

In no event shall TI's liability arising out of such information exceed the total purchase price of the TI part(s) at issue in this document sold by TI to Customer on an annual basis.

**TAPE AND REEL INFORMATION**

**QUADRANT ASSIGNMENTS FOR PIN 1 ORIENTATION IN TAPE**

\*All dimensions are nominal

Device	Package Type	Package Drawing	Pins	SPQ	Reel Diameter (mm)	Reel Width W1 (mm)	A0 (mm)	B0 (mm)	K0 (mm)	P1 (mm)	W (mm)	Pin1 Quadrant
LMC6762AIMX	SOIC	D	8	2500	330.0	12.4	6.5	5.4	2.0	8.0	12.0	Q1
LMC6762AIMX/NOPB	SOIC	D	8	2500	330.0	12.4	6.5	5.4	2.0	8.0	12.0	Q1
LMC6762BIMX	SOIC	D	8	2500	330.0	12.4	6.5	5.4	2.0	8.0	12.0	Q1
LMC6762BIMX/NOPB	SOIC	D	8	2500	330.0	12.4	6.5	5.4	2.0	8.0	12.0	Q1

**TAPE AND REEL BOX DIMENSIONS**

\*All dimensions are nominal

Device	Package Type	Package Drawing	Pins	SPQ	Length (mm)	Width (mm)	Height (mm)
LMC6762AIMX	SOIC	D	8	2500	367.0	367.0	35.0
LMC6762AIMX/NOPB	SOIC	D	8	2500	367.0	367.0	35.0
LMC6762BIMX	SOIC	D	8	2500	367.0	367.0	35.0
LMC6762BIMX/NOPB	SOIC	D	8	2500	367.0	367.0	35.0



D0008A

# PACKAGE OUTLINE

SOIC - 1.75 mm max height

SMALL OUTLINE INTEGRATED CIRCUIT



4214825/C 02/2019

NOTES:

- Linear dimensions are in inches [millimeters]. Dimensions in parenthesis are for reference only. Controlling dimensions are in inches. Dimensioning and tolerancing per ASME Y14.5M.
- This drawing is subject to change without notice.
- This dimension does not include mold flash, protrusions, or gate burrs. Mold flash, protrusions, or gate burrs shall not exceed .006 [0.15] per side.
- This dimension does not include interlead flash.
- Reference JEDEC registration MS-012, variation AA.

# EXAMPLE BOARD LAYOUT

D0008A

SOIC - 1.75 mm max height

SMALL OUTLINE INTEGRATED CIRCUIT

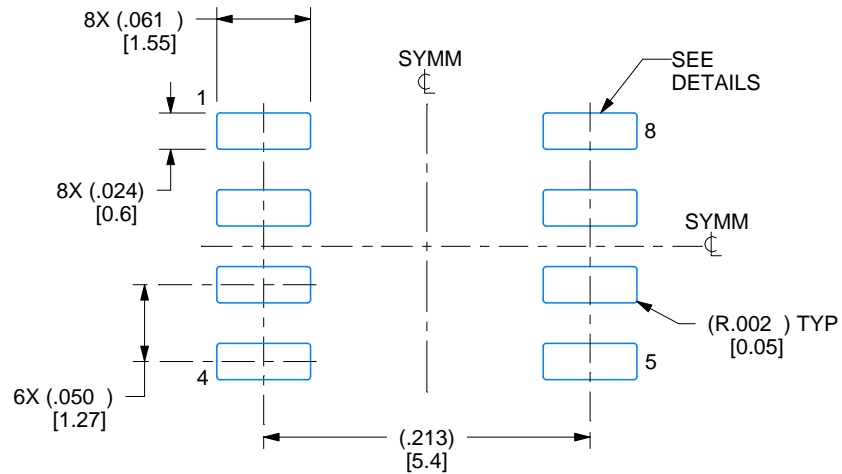

LAND PATTERN EXAMPLE  
EXPOSED METAL SHOWN  
SCALE:8X

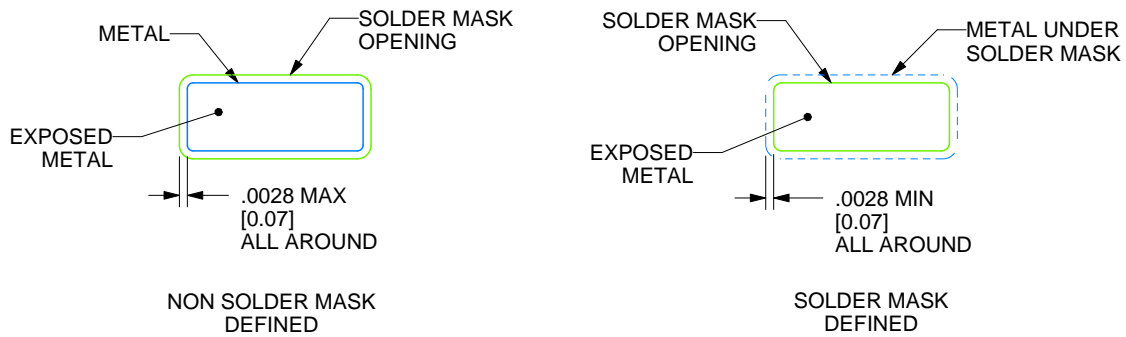

SOLDER MASK DETAILS

4214825/C 02/2019

NOTES: (continued)

6. Publication IPC-7351 may have alternate designs.

7. Solder mask tolerances between and around signal pads can vary based on board fabrication site.

# EXAMPLE STENCIL DESIGN

D0008A

SOIC - 1.75 mm max height

SMALL OUTLINE INTEGRATED CIRCUIT



SOLDER PASTE EXAMPLE  
BASED ON .005 INCH [0.125 MM] THICK STENCIL  
SCALE:8X

4214825/C 02/2019

NOTES: (continued)

8. Laser cutting apertures with trapezoidal walls and rounded corners may offer better paste release. IPC-7525 may have alternate design recommendations.
9. Board assembly site may have different recommendations for stencil design.

## IMPORTANT NOTICE AND DISCLAIMER

TI PROVIDES TECHNICAL AND RELIABILITY DATA (INCLUDING DATASHEETS), DESIGN RESOURCES (INCLUDING REFERENCE DESIGNS), APPLICATION OR OTHER DESIGN ADVICE, WEB TOOLS, SAFETY INFORMATION, AND OTHER RESOURCES "AS IS" AND WITH ALL FAULTS, AND DISCLAIMS ALL WARRANTIES, EXPRESS AND IMPLIED, INCLUDING WITHOUT LIMITATION ANY IMPLIED WARRANTIES OF MERCHANTABILITY, FITNESS FOR A PARTICULAR PURPOSE OR NON-INFRINGEMENT OF THIRD PARTY INTELLECTUAL PROPERTY RIGHTS.

These resources are intended for skilled developers designing with TI products. You are solely responsible for (1) selecting the appropriate TI products for your application, (2) designing, validating and testing your application, and (3) ensuring your application meets applicable standards, and any other safety, security, or other requirements. These resources are subject to change without notice. TI grants you permission to use these resources only for development of an application that uses the TI products described in the resource. Other reproduction and display of these resources is prohibited. No license is granted to any other TI intellectual property right or to any third party intellectual property right. TI disclaims responsibility for, and you will fully indemnify TI and its representatives against, any claims, damages, costs, losses, and liabilities arising out of your use of these resources.

TI's products are provided subject to TI's Terms of Sale ([www.ti.com/legal/termsofsale.html](http://www.ti.com/legal/termsofsale.html)) or other applicable terms available either on [ti.com](http://ti.com) or provided in conjunction with such TI products. TI's provision of these resources does not expand or otherwise alter TI's applicable warranties or warranty disclaimers for TI products.

Mailing Address: Texas Instruments, Post Office Box 655303, Dallas, Texas 75265  
Copyright © 2019, Texas Instruments Incorporated

## Looking for pricing, stock, or lifecycle information?

Click below to explore more details on WIN SOURCE:

 [View LMC6762AIM](#) on WIN SOURCE

 [Texas Instruments](#) Information

## Optimize Your Supply Chain with WIN SOURCE Solutions

-  Global Sourcing Solution
-  Obsolete Management
-  Cost Control Management
-  Shortage Management
-  Alternative Solution
-  Excess Inventory Management