



# THE DATASHEET OF LMC660AIMX/NOPB



## LMC660 CMOS Quad Operational Amplifier

Check for Samples: [LMC660](#)

### FEATURES

- Rail-to-Rail Output Swing
- Specified for 2 k $\Omega$  and 600 $\Omega$  Loads
- High Voltage Gain: 126 dB
- Low Input Offset Voltage: 3 mV
- Low Offset Voltage Drift: 1.3  $\mu\text{V}/^\circ\text{C}$
- Ultra Low Input Bias Current: 2 fA
- Input Common-Mode Range Includes  $V^-$
- Operating Range from +5V to +15.5V Supply
- $I_{SS} = 375 \mu\text{A}/\text{Amplifier}$ ; Independent of  $V^+$
- Low Distortion: 0.01% at 10 kHz
- Slew Rate: 1.1 V/ $\mu\text{s}$

### APPLICATIONS

- High-Impedance Buffer or Preamplifier
- Precision Current-to-Voltage Converter
- Long-Term Integrator
- Sample-and-Hold Circuit
- Peak Detector
- Medical Instrumentation
- Industrial Controls
- Automotive Sensors

### Connection Diagrams

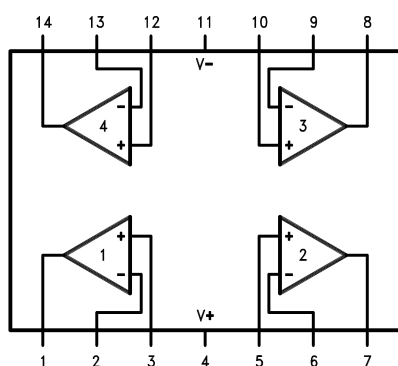
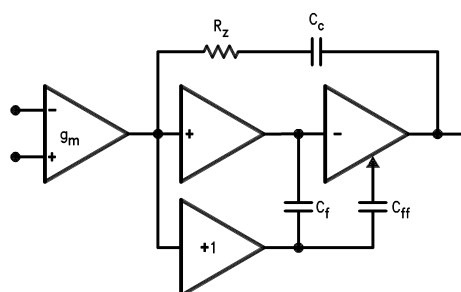
**Figure 1. 14-Pin SOIC/PDIP**

**Figure 2. LMC660 Circuit Topology (Each Amplifier)**

Please be aware that an important notice concerning availability, standard warranty, and use in critical applications of Texas Instruments semiconductor products and disclaimers thereto appears at the end of this data sheet.

All trademarks are the property of their respective owners.



These devices have limited built-in ESD protection. The leads should be shorted together or the device placed in conductive foam during storage or handling to prevent electrostatic damage to the MOS gates.

### Absolute Maximum Ratings<sup>(1)</sup>

Differential Input Voltage	±Supply Voltage
Supply Voltage	16V
Output Short Circuit to V <sup>+</sup>	See <sup>(2)</sup>
Output Short Circuit to V <sup>-</sup>	See <sup>(3)</sup>
Lead Temperature (Soldering, 10 sec.)	260°C
Storage Temp. Range	-65°C to +150°C
Voltage at Input/Output Pins	(V <sup>+</sup> ) + 0.3V, (V <sup>-</sup> ) - 0.3V
Current at Output Pin	±18 mA
Current at Input Pin	±5 mA
Current at Power Supply Pin	35 mA
Power Dissipation	See <sup>(4)</sup>
Junction Temperature	150°C
ESD tolerance <sup>(5)</sup>	1000V

- (1) Absolute Maximum Ratings indicate limits beyond which damage to the device may occur. Operating Ratings indicate conditions for which the device is intended to be functional, but do not ensure specific performance limits. For ensured specifications and test conditions, see the Electrical Characteristics. The ensured specifications apply only for the test conditions listed.
- (2) Do not connect output to V<sup>+</sup> when V<sup>+</sup> is greater than 13V or reliability may be adversely affected.
- (3) Applies to both single supply and split supply operation. Continuous short circuit operation at elevated ambient temperature and/or multiple Op Amp shorts can result in exceeding the maximum allowed junction temperature of 150°C. Output currents in excess of ±30 mA over long term may adversely affect reliability.
- (4) The maximum power dissipation is a function of T<sub>J(MAX)</sub>, θ<sub>JA</sub>, and T<sub>A</sub>. The maximum allowable power dissipation at any ambient temperature is P<sub>D</sub> = (T<sub>J(MAX)</sub> - T<sub>A</sub>)/θ<sub>JA</sub>.
- (5) Human Body Model is 1.5 kΩ in series with 100 pF.

### Operating Ratings

Temperature Range	
LMC660AI	-40°C ≤ T <sub>J</sub> ≤ +85°C
LMC660C	0°C ≤ T <sub>J</sub> ≤ +70°C
Supply Voltage Range	4.75V to 15.5V
Power Dissipation	See <sup>(1)</sup>
Thermal Resistance (θ <sub>JA</sub> ) <sup>(2)</sup>	
14-Pin SOIC	115°C/W
14-Pin PDIP	85°C/W

- (1) For operating at elevated temperatures the device must be derated based on the thermal resistance θ<sub>JA</sub> with P<sub>D</sub> = (T<sub>J</sub> - T<sub>A</sub>)/θ<sub>JA</sub>.
- (2) All numbers apply for packages soldered directly into a PC board.

## DC Electrical Characteristics

Unless otherwise specified, all limits ensured for  $T_J = 25^\circ\text{C}$ . **Boldface** limits apply at the temperature extremes.  $V^+ = 5\text{V}$ ,  $V^- = 0\text{V}$ ,  $V_{CM} = 1.5\text{V}$ ,  $V_O = 2.5\text{V}$  and  $R_L > 1\text{M}\Omega$  unless otherwise specified.

Parameter	Test Conditions	Typ <sup>(1)</sup>	LMC660AI Limit <sup>(1)</sup>	LMC660C Limit <sup>(1)</sup>	Units
Input Offset Voltage		1	3 <b>3.3</b>	6 <b>6.3</b>	mV max
Input Offset Voltage Average Drift		1.3			$\mu\text{V}/^\circ\text{C}$
Input Bias Current		0.002	<b>4</b>	<b>2</b>	pA max
Input Offset Current		0.001	<b>2</b>	<b>1</b>	pA max
Input Resistance		>1			Tera $\Omega$
Common Mode Rejection Ratio	$0\text{V} \leq V_{CM} \leq 12.0\text{V}$ $V^+ = 15\text{V}$	83	70 <b>68</b>	63 <b>62</b>	dB min
Positive Power Supply Rejection Ratio	$5\text{V} \leq V^+ \leq 15\text{V}$ $V_O = 2.5\text{V}$	83	70 <b>68</b>	63 <b>62</b>	dB min
Negative Power Supply Rejection Ratio	$0\text{V} \leq V^- \leq -10\text{V}$	94	84 <b>83</b>	74 <b>73</b>	dB min
Input Common-Mode Voltage Range	$V^+ = 5\text{V}$ & $15\text{V}$ For CMRR $\geq 50$ dB	-0.4	-0.1 <b>0</b>	-0.1 <b>0</b>	V max
		$V^+ - 1.9$	$V^+ - 2.3$ <b><math>V^+ - 2.5</math></b>	$V^+ - 2.3$ <b><math>V^+ - 2.4</math></b>	V min
Large Signal Voltage Gain	$R_L = 2\text{ k}\Omega$ <sup>(2)</sup> Sourcing Sinking	2000	440 <b>400</b>	300 <b>200</b>	V/mV min
		500	180 <b>120</b>	90 <b>80</b>	V/mV min
	$R_L = 600\Omega$ <sup>(2)</sup> Sourcing Sinking	1000	220 <b>200</b>	150 <b>100</b>	V/mV min
		250	100 <b>60</b>	50 <b>40</b>	V/mV min
Output Swing	$V^+ = 5\text{V}$ $R_L = 2\text{ k}\Omega$ to $V^+/2$	4.87	4.82 <b>4.79</b>	4.78 <b>4.76</b>	V min
		0.10	0.15 <b>0.17</b>	0.19 <b>0.21</b>	V max
	$V^+ = 5\text{V}$ $R_L = 600\Omega$ to $V^+/2$	4.61	4.41 <b>4.31</b>	4.27 <b>4.21</b>	V min
		0.30	0.50 <b>0.56</b>	0.63 <b>0.69</b>	V max
	$V^+ = 15\text{V}$ $R_L = 2\text{ k}\Omega$ to $V^+/2$	14.63	14.50 <b>14.44</b>	14.37 <b>14.32</b>	V min
		0.26	0.35 <b>0.40</b>	0.44 <b>0.48</b>	V max
	$V^+ = 15\text{V}$ $R_L = 600\Omega$ to $V^+/2$	13.90	13.35 <b>13.15</b>	12.92 <b>12.76</b>	V min
		0.79	1.16 <b>1.32</b>	1.45 <b>1.58</b>	V max

(1) Typical values represent the most likely parametric norm. Limits are specified by testing or correlation.

(2)  $V^+ = 15\text{V}$ ,  $V_{CM} = 7.5\text{V}$  and  $R_L$  connected to  $7.5\text{V}$ . For Sourcing tests,  $7.5\text{V} \leq V_O \leq 11.5\text{V}$ . For Sinking tests,  $2.5\text{V} \leq V_O \leq 7.5\text{V}$ .

## DC Electrical Characteristics (continued)

Unless otherwise specified, all limits ensured for  $T_J = 25^\circ\text{C}$ . **Boldface** limits apply at the temperature extremes.  $V^+ = 5\text{V}$ ,  $V^- = 0\text{V}$ ,  $V_{\text{CM}} = 1.5\text{V}$ ,  $V_O = 2.5\text{V}$  and  $R_L > 1\text{M}\Omega$  unless otherwise specified.

Parameter	Test Conditions	Typ <sup>(1)</sup>	LMC660AI Limit <sup>(1)</sup>	LMC660C Limit <sup>(1)</sup>	Units
Output Current $V^+ = 5\text{V}$	Sourcing, $V_O = 0\text{V}$	22	16 <b>14</b>	13 <b>11</b>	mA min
	Sinking, $V_O = 5\text{V}$	21	16 <b>14</b>	13 <b>11</b>	mA min
Output Current $V^+ = 15\text{V}$	Sourcing, $V_O = 0\text{V}$	40	28 <b>25</b>	23 <b>21</b>	mA min
	Sinking, $V_O = 13\text{V}^{(3)}$	39	28 <b>24</b>	23 <b>20</b>	mA min
Supply Current	All Four Amplifiers $V_O = 1.5\text{V}$	1.5	2.2 <b>2.6</b>	2.7 <b>2.9</b>	mA max

(3) Do not connect output to  $V^+$  when  $V^+$  is greater than 13V or reliability may be adversely affected.

## AC Electrical Characteristics

Unless otherwise specified, all limits ensured for  $T_J = 25^\circ\text{C}$ . **Boldface** limits apply at the temperature extremes.  $V^+ = 5\text{V}$ ,  $V^- = 0\text{V}$ ,  $V_{\text{CM}} = 1.5\text{V}$ ,  $V_O = 2.5\text{V}$  and  $R_L > 1\text{M}\Omega$  unless otherwise specified.

Parameter	Test Conditions	Typ <sup>(1)</sup>	LMC660AI Limit <sup>(1)</sup>	LMC660C Limit <sup>(1)</sup>	Units
Slew Rate	See <sup>(2)</sup>	1.1	0.8 <b>0.6</b>	0.8 <b>0.7</b>	V/ $\mu\text{s}$ min
Gain-Bandwidth Product		1.4			MHz
Phase Margin		50			Deg
Gain Margin		17			dB
Amp-to-Amp Isolation	See <sup>(3)</sup>	130			dB
Input Referred Voltage Noise	$f = 1\text{ kHz}$	22			nV/ $\sqrt{\text{Hz}}$
Input Referred Current Noise	$f = 1\text{ kHz}$	0.0002			pA/ $\sqrt{\text{Hz}}$
Total Harmonic Distortion	$f = 10\text{ kHz}$ , $A_V = -10$ $R_L = 2\text{ k}\Omega$ , $V_O = 8\text{ V}_{\text{PP}}$ $V^+ = 15\text{V}$	0.01			%

(1) Typical values represent the most likely parametric norm. Limits are specified by testing or correlation.

(2)  $V^+ = 15\text{V}$ . Connected as Voltage Follower with 10V step input. Number specified is the slower of the positive and negative slew rates.

(3) Input referred.  $V^+ = 15\text{V}$  and  $R_L = 10\text{ k}\Omega$  connected to  $V^+/2$ . Each amp excited in turn with 1 kHz to produce  $V_O = 13\text{ V}_{\text{PP}}$ .

### Typical Performance Characteristics

$V_S = \pm 7.5V$ ,  $T_A = 25^\circ C$  unless otherwise specified.

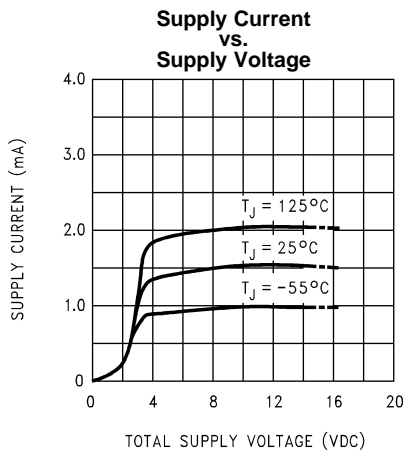

Figure 3.

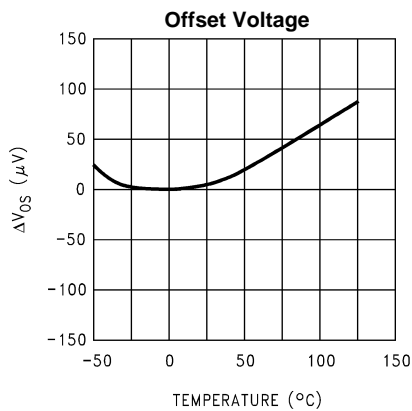

Figure 4.

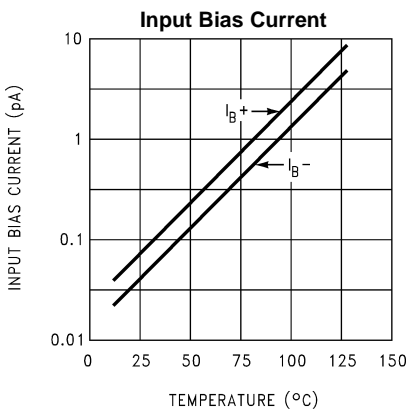

Figure 5.

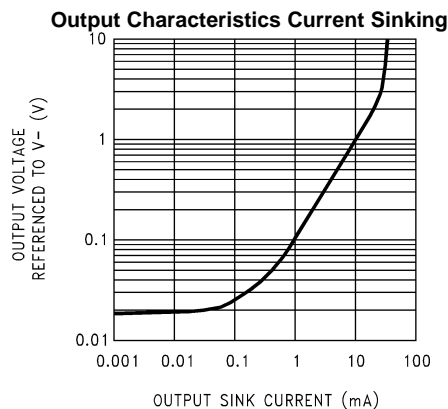

Figure 6.

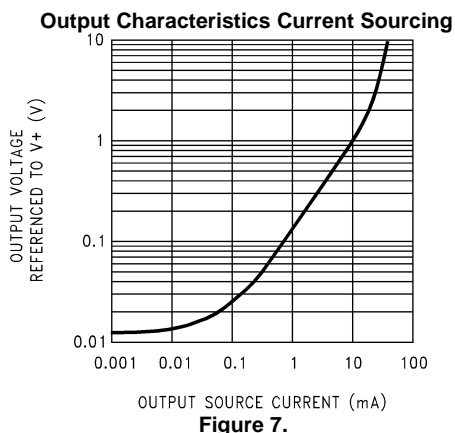

Figure 7.

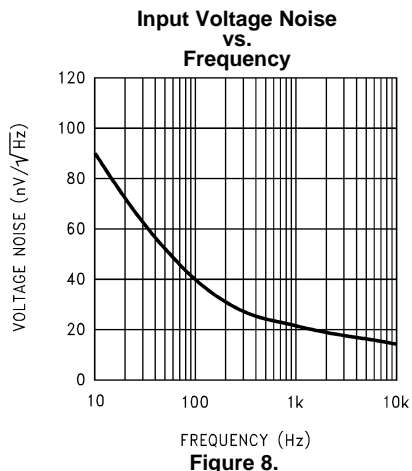

Figure 8.

**Typical Performance Characteristics (continued)**

$V_S = \pm 7.5V$ ,  $T_A = 25^\circ C$  unless otherwise specified.

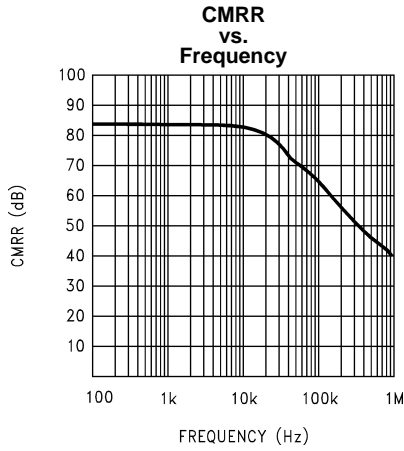

Figure 9.

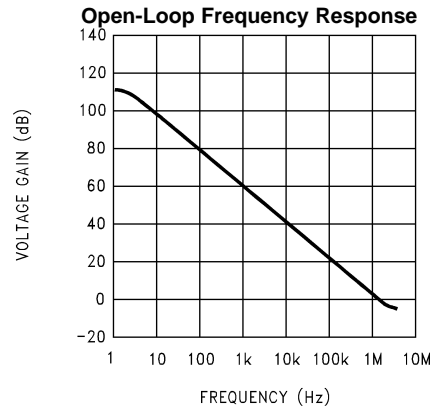

Figure 10.

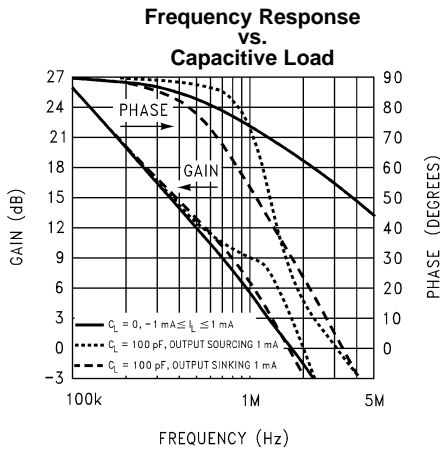

Figure 11.

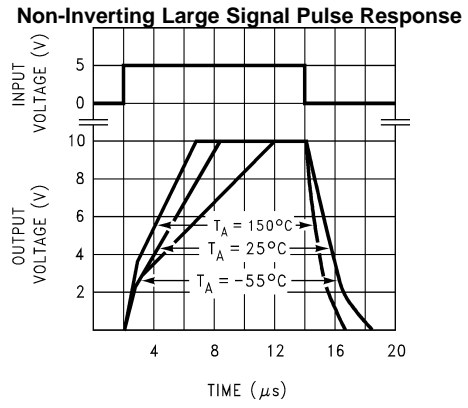

Figure 12.

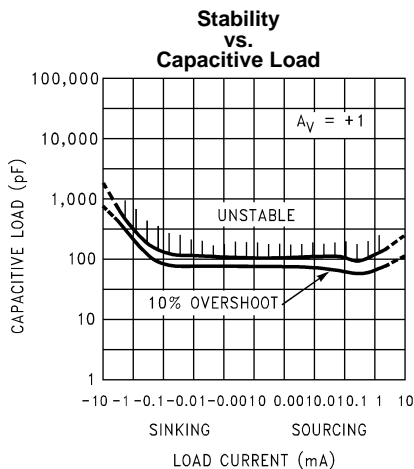

Figure 13.

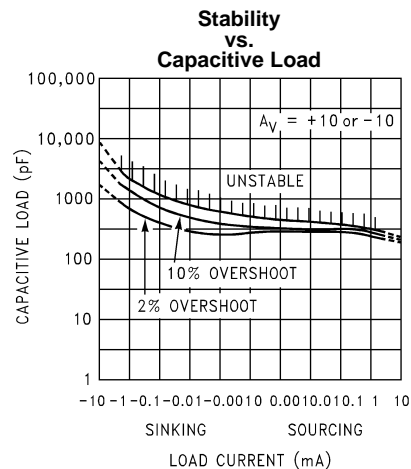

Figure 14.

## APPLICATION INFORMATION

### AMPLIFIER TOPOLOGY

The topology chosen for the LMC660, shown in [Figure 15](#), is unconventional (compared to general-purpose op amps) in that the traditional unity-gain buffer output stage is not used; instead, the output is taken directly from the output of the integrator, to allow rail-to-rail output swing. Since the buffer traditionally delivers the power to the load, while maintaining high op amp gain and stability, and must withstand shorts to either rail, these tasks now fall to the integrator.

As a result of these demands, the integrator is a compound affair with an embedded gain stage that is doubly fed forward (via  $C_f$  and  $C_{ff}$ ) by a dedicated unity-gain compensation driver. In addition, the output portion of the integrator is a push-pull configuration for delivering heavy loads. While sinking current the whole amplifier path consists of three gain stages with one stage fed forward, whereas while sourcing the path contains four gain stages with two fed forward.

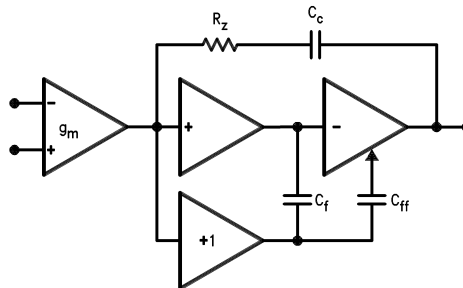

Figure 15. LMC660 Circuit Topology (Each Amplifier)

The large signal voltage gain while sourcing is comparable to traditional bipolar op amps, even with a 600Ω load. The gain while sinking is higher than most CMOS op amps, due to the additional gain stage; however, under heavy load (600Ω) the gain will be reduced as indicated in [DC Electrical Characteristics](#). Avoid resistive loads of less than 500Ω, as they may cause instability.

### COMPENSATING INPUT CAPACITANCE

The high input resistance of the LMC660 op amps allows the use of large feedback and source resistor values without losing gain accuracy due to loading. However, the circuit will be especially sensitive to its layout when these large-value resistors are used.

Every amplifier has some capacitance between each input and AC ground, and also some differential capacitance between the inputs. When the feedback network around an amplifier is resistive, this input capacitance (along with any additional capacitance due to circuit board traces, the socket, etc.) and the feedback resistors create a pole in the feedback path. In the following General Operational Amplifier circuit, [Figure 16](#) the frequency of this pole is:

$$f_p = \frac{1}{2\pi C_S R_P} \quad (1)$$

where  $C_S$  is the total capacitance at the inverting input, including amplifier input capacitance and any stray capacitance from the IC socket (if one is used), circuit board traces, etc., and  $R_P$  is the parallel combination of  $R_F$  and  $R_{IN}$ . This formula, as well as all formulae derived below, apply to inverting and non-inverting op amp configurations.

When the feedback resistors are smaller than a few kΩ, the frequency of the feedback pole will be quite high, since  $C_S$  is generally less than 10 pF. If the frequency of the feedback pole is much higher than the “ideal” closed-loop bandwidth (the nominal closed-loop bandwidth in the absence of  $C_S$ ), the pole will have a negligible effect on stability, as it will add only a small amount of phase shift.

However, if the feedback pole is less than approximately 6 to 10 times the “ideal” –3 dB frequency, a feedback capacitor,  $C_F$ , should be connected between the output and the inverting input of the op amp. This condition can also be stated in terms of the amplifier’s low-frequency noise gain: To maintain stability a feedback capacitor will probably be needed if:

$$\left(\frac{R_F}{R_{IN}} + 1\right) \leq \sqrt{6 \times 2\pi \times \text{GBW} \times R_F \times C_S} \quad (2)$$

where:

$$\left(\frac{R_F}{R_{IN}} + 1\right) \quad (3)$$

is the amplifier's low-frequency noise gain and GBW is the amplifier's gain bandwidth product. An amplifier's low-frequency noise gain is represented by the formula:

$$\left(\frac{R_F}{R_{IN}} + 1\right) \quad (4)$$

regardless of whether the amplifier is being used in inverting or non-inverting mode. Note that a feedback capacitor is more likely to be needed when the noise gain is low and/or the feedback resistor is large.

If the above condition is met (indicating a feedback capacitor will probably be needed), and the noise gain is large enough that:

$$\left(\frac{R_F}{R_{IN}} + 1\right) \geq 2\sqrt{\text{GBW} \times R_F \times C_S} \quad (5)$$

the following value of feedback capacitor is recommended:

$$C_F = \frac{C_S}{2\left(\frac{R_F}{R_{IN}} + 1\right)} \quad (6)$$

If

$$\left(\frac{R_F}{R_{IN}} + 1\right) < 2\sqrt{\text{GBW} \times R_F \times C_S} \quad (7)$$

the feedback capacitor should be:

$$C_F = \sqrt{\frac{C_S}{\text{GBW} \times R_F}} \quad (8)$$

Note that these capacitor values are usually significant smaller than those given by the older, more conservative formula:

$$C_F = \frac{C_S R_{IN}}{R_F} \quad (9)$$

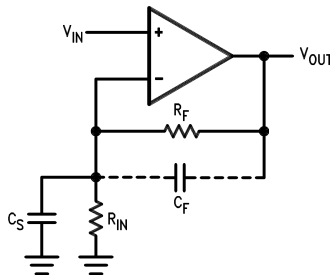

$C_S$  consists of the amplifier's input capacitance plus any stray capacitance from the circuit board and socket.  $C_F$  compensates for the pole caused by  $C_S$  and the feedback resistors.

**Figure 16. General Operational Amplifier Circuit**

Using the smaller capacitors will give much higher bandwidth with little degradation of transient response. It may be necessary in any of the above cases to use a somewhat larger feedback capacitor to allow for unexpected stray capacitance, or to tolerate additional phase shifts in the loop, or excessive capacitive load, or to decrease the noise or bandwidth, or simply because the particular circuit implementation needs more feedback capacitance to be sufficiently stable. For example, a printed circuit board's stray capacitance may be larger or smaller than the breadboard's, so the actual optimum value for  $C_F$  may be different from the one estimated using the breadboard. In most cases, the values of  $C_F$  should be checked on the actual circuit, starting with the computed value.

## CAPACITIVE LOAD TOLERANCE

Like many other op amps, the LMC660 may oscillate when its applied load appears capacitive. The threshold of oscillation varies both with load and circuit gain. The configuration most sensitive to oscillation is a unity-gain follower. See [Typical Performance Characteristics](#).

The load capacitance interacts with the op amp's output resistance to create an additional pole. If this pole frequency is sufficiently low, it will degrade the op amp's phase margin so that the amplifier is no longer stable at low gains. As shown in [Figure 17](#), the addition of a small resistor ( $50\Omega$  to  $100\Omega$ ) in series with the op amp's output, and a capacitor ( $5\text{ pF}$  to  $10\text{ pF}$ ) from inverting input to output pins, returns the phase margin to a safe value without interfering with lower-frequency circuit operation. Thus larger values of capacitance can be tolerated without oscillation. Note that in all cases, the output will ring heavily when the load capacitance is near the threshold for oscillation.

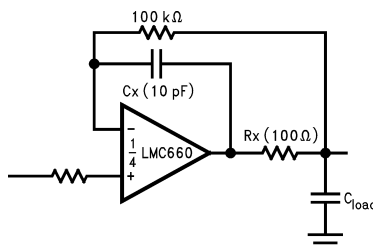

Figure 17. Rx, Cx Improve Capacitive Load Tolerance

Capacitive load driving capability is enhanced by using a pull up resistor to  $V^+$  ([Figure 18](#)). Typically a pull up resistor conducting  $500\ \mu\text{A}$  or more will significantly improve capacitive load responses. The value of the pull up resistor must be determined based on the current sinking capability of the amplifier with respect to the desired output swing. Open loop gain of the amplifier can also be affected by the pull up resistor (see [DC Electrical Characteristics](#)).

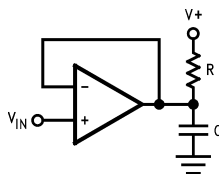

Figure 18. Compensating for Large Capacitive Loads with a Pull Up Resistor

## PRINTED-CIRCUIT-BOARD LAYOUT FOR HIGH-IMPEDANCE WORK

It is generally recognized that any circuit which must operate with less than  $1000\text{ pA}$  of leakage current requires special layout of the PC board. When one wishes to take advantage of the ultra-low bias current of the LMC662, typically less than  $0.04\text{ pA}$ , it is essential to have an excellent layout. Fortunately, the techniques for obtaining low leakages are quite simple. First, the user must not ignore the surface leakage of the PC board, even though it may sometimes appear acceptably low, because under conditions of high humidity or dust or contamination, the surface leakage will be appreciable.

To minimize the effect of any surface leakage, lay out a ring of foil completely surrounding the LMC660's inputs and the terminals of capacitors, diodes, conductors, resistors, relay terminals, etc. connected to the op amp's inputs. See [Figure 19](#). To have a significant effect, guard rings should be placed on both the top and bottom of the PC board. This PC foil must then be connected to a voltage which is at the same voltage as the amplifier inputs, since no leakage current can flow between two points at the same potential. For example, a PC board trace-to-pad resistance of  $10^{12}\Omega$ , which is normally considered a very large resistance, could leak  $5\text{ pA}$  if the trace were a  $5\text{V}$  bus adjacent to the pad of an input. This would cause a 100 times degradation from the LMC660's actual performance. However, if a guard ring is held within  $5\text{ mV}$  of the inputs, then even a resistance of  $10^{11}\Omega$  would cause only  $0.05\text{ pA}$  of leakage current, or perhaps a minor (2:1) degradation of the amplifier's performance. See [Figure 20a](#), [Figure 20b](#), and [Figure 20c](#) for typical connections of guard rings for standard op amp configurations. If both inputs are active and at high impedance, the guard can be tied to ground and still provide some protection; see [Figure 20d](#).

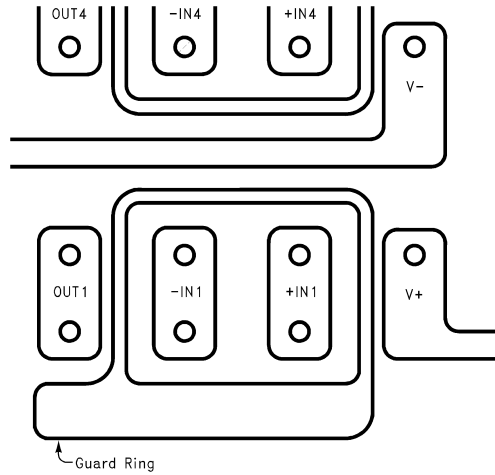

Figure 19. Example, using the LMC660, of Guard Ring in P.C. Board Layout

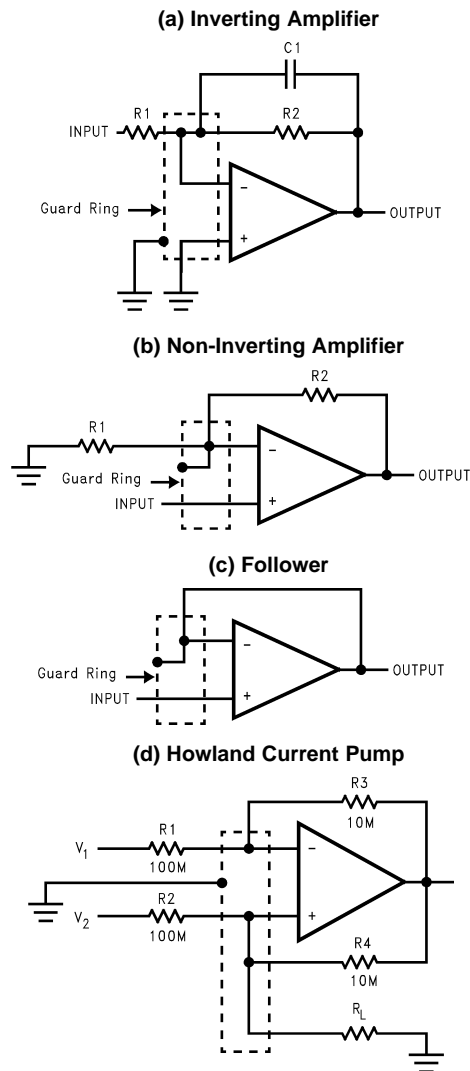
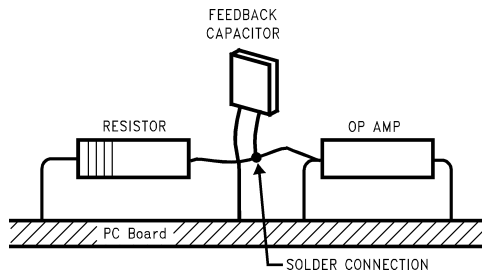

Figure 20. Guard Ring Connections

The designer should be aware that when it is inappropriate to lay out a PC board for the sake of just a few circuits, there is another technique which is even better than a guard ring on a PC board: Don't insert the amplifier's input pin into the board at all, but bend it up in the air and use only air as an insulator. Air is an excellent insulator. In this case you may have to forego some of the advantages of PC board construction, but the advantages are sometimes well worth the effort of using point-to-point up-in-the-air wiring. See [Figure 21](#).



(Input pins are lifted out of PC board and soldered directly to components. All other pins connected to PC board.)

**Figure 21. Air Wiring**

**BIAS CURRENT TESTING**

The test method of [Figure 21](#) is appropriate for bench-testing bias current with reasonable accuracy. To understand its operation, first close switch S2 momentarily. When S2 is opened, then:

$$I_{b-} = \frac{dV_{OUT}}{dt} \times C2. \tag{10}$$

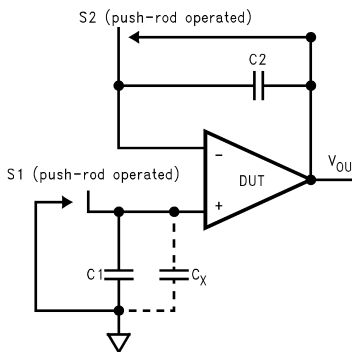

**Figure 22. Simple Input Bias Current Test Circuit**

A suitable capacitor for C2 would be a 5 pF or 10 pF silver mica, NPO ceramic, or air-dielectric. When determining the magnitude of  $I_{b-}$ , the leakage of the capacitor and socket must be taken into account. Switch S2 should be left shorted most of the time, or else the dielectric absorption of the capacitor C2 could cause errors.

Similarly, if S1 is shorted momentarily (while leaving S2 shorted):

$$I_{b+} = \frac{dV_{OUT}}{dt} \times (C1 + C_x) \tag{11}$$

where  $C_x$  is the stray capacitance at the + input.

**TYPICAL SINGLE-SUPPLY APPLICATIONS**

(V<sup>+</sup> = 5.0 VDC)

Additional single-supply applications ideas can be found in the LM324 datasheet. The LMC660 is pin-for-pin compatible with the LM324 and offers greater bandwidth and input resistance over the LM324. These features will improve the performance of many existing single-supply applications. Note, however, that the supply voltage range of the LMC660 is smaller than that of the LM324.

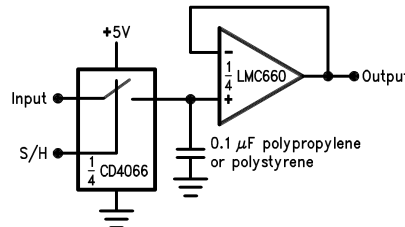

**Figure 23. Low-Leakage Sample-and-Hold**

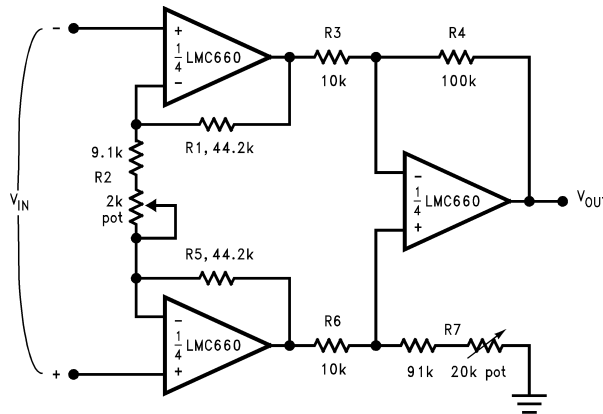

**Figure 24. Instrumentation Amplifier**

If R<sub>1</sub> = R<sub>5</sub>, R<sub>3</sub> = R<sub>6</sub>, and R<sub>4</sub> = R<sub>7</sub>; then

$$\frac{V_{OUT}}{V_{IN}} = \frac{R_2 + 2R_1}{R_2} \times \frac{R_4}{R_3} \tag{12}$$

∴ A<sub>v</sub> ≈ 100 for circuit shown.

For good CMRR over temperature, low drift resistors should be used. Matching of R<sub>3</sub> to R<sub>6</sub> and R<sub>4</sub> to R<sub>7</sub> affect CMRR. Gain may be adjusted through R<sub>2</sub>. CMRR may be adjusted through R<sub>7</sub>.

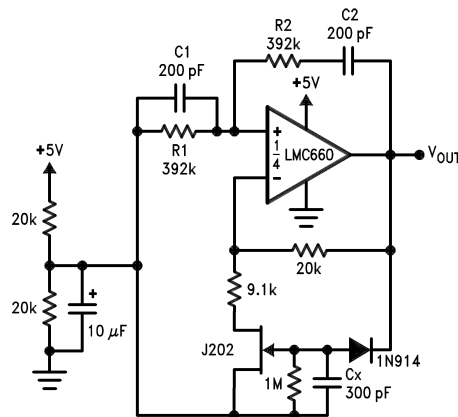

**Figure 25. Sine-Wave Oscillator**

Oscillator frequency is determined by R<sub>1</sub>, R<sub>2</sub>, C<sub>1</sub>, and C<sub>2</sub>:

TYPICAL SINGLE-SUPPLY APPLICATIONS (continued)

(V+ = 5.0 VDC)

$f_{osc} = 1/2\pi RC$ , where  $R = R1 = R2$  and  $C = C1 = C2$ .

This circuit, as shown, oscillates at 2.0 kHz with a peak-to-peak output swing of 4.5V.

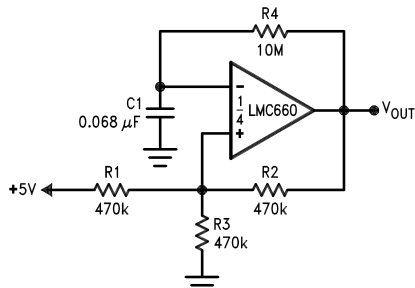

Figure 26. 1 Hz Square-Wave Oscillator

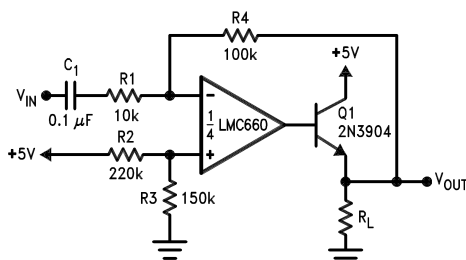

Figure 27. Power Amplifier

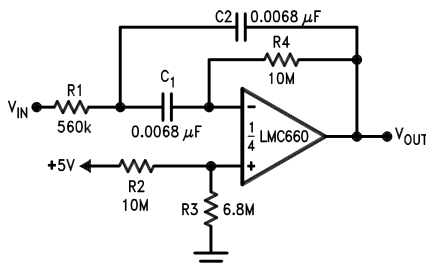

Figure 28. 10 Hz Bandpass Filter

$f_0 = 10$  Hz  
 $Q = 2.1$   
Gain = -8.8

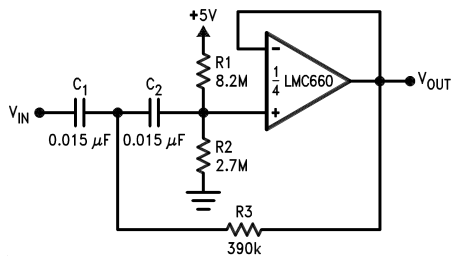

Figure 29. 10 Hz High-Pass Filter

$f_c = 10$  Hz  
 $d = 0.895$   
Gain = 1  
2 dB passband ripple

TYPICAL SINGLE-SUPPLY APPLICATIONS (continued)

(V+ = 5.0 VDC)

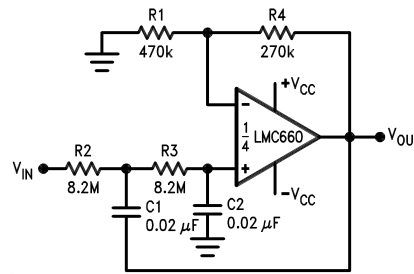

Figure 30. 1 Hz Low-Pass Filter (Maximally Flat, Dual Supply Only)

$f_c = 1 \text{ Hz}$   
 $d = 1.414$   
 Gain = 1.57

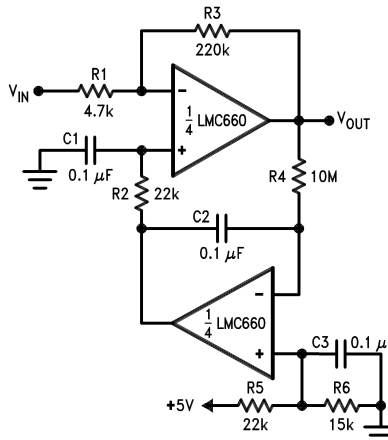

Figure 31. High Gain Amplifier with Offset Voltage Reduction

Gain = -46.8  
 Output offset voltage reduced to the level of the input offset voltage of the bottom amplifier (typically 1 mV).

---

**REVISION HISTORY**

<b>Changes from Revision C (March 2013) to Revision D</b>	<b>Page</b>
<hr/> <ul style="list-style-type: none"><li>• Changed layout of National Data Sheet to TI format .....</li></ul>	<hr/> <a href="#">14</a>

**PACKAGING INFORMATION**

Orderable Device	Status (1)	Package Type	Package Drawing	Pins	Package Qty	Eco Plan (2)	Lead/Ball Finish (6)	MSL Peak Temp (3)	Op Temp (°C)	Device Marking (4/5)	Samples
LMC660AIM	NRND	SOIC	D	14	55	TBD	Call TI	Call TI	-40 to 85	LMC660AIM	
LMC660AIM/NOPB	ACTIVE	SOIC	D	14	55	Green (RoHS & no Sb/Br)	CU SN	Level-1-260C-UNLIM	-40 to 85	LMC660AIM	
LMC660AIMX	NRND	SOIC	D	14	2500	TBD	Call TI	Call TI	-40 to 85	LMC660AIM	
LMC660AIMX/NOPB	ACTIVE	SOIC	D	14	2500	Green (RoHS & no Sb/Br)	CU SN	Level-1-260C-UNLIM	-40 to 85	LMC660AIM	
LMC660AIN/NOPB	ACTIVE	PDIP	NFF	14	25	Green (RoHS & no Sb/Br)	CU SN	Level-1-NA-UNLIM	-40 to 85	LMC660AIN	
LMC660CM	NRND	SOIC	D	14	55	TBD	Call TI	Call TI	0 to 70	LMC660CM	
LMC660CM/NOPB	ACTIVE	SOIC	D	14	55	Green (RoHS & no Sb/Br)	CU SN	Level-1-260C-UNLIM	0 to 70	LMC660CM	
LMC660CMX/NOPB	ACTIVE	SOIC	D	14	2500	Green (RoHS & no Sb/Br)	CU SN	Level-1-260C-UNLIM	0 to 70	LMC660CM	
LMC660CN/NOPB	ACTIVE	PDIP	NFF	14	25	Green (RoHS & no Sb/Br)	CU SN	Level-1-NA-UNLIM	0 to 70	LMC660CN	

(1) The marketing status values are defined as follows:

**ACTIVE:** Product device recommended for new designs.

**LIFEBUY:** TI has announced that the device will be discontinued, and a lifetime-buy period is in effect.

**NRND:** Not recommended for new designs. Device is in production to support existing customers, but TI does not recommend using this part in a new design.

**PREVIEW:** Device has been announced but is not in production. Samples may or may not be available.

**OBSELETE:** TI has discontinued the production of the device.

(2) Eco Plan - The planned eco-friendly classification: Pb-Free (RoHS), Pb-Free (RoHS Exempt), or Green (RoHS & no Sb/Br) - please check <http://www.ti.com/productcontent> for the latest availability information and additional product content details.

**TBD:** The Pb-Free/Green conversion plan has not been defined.

**Pb-Free (RoHS):** TI's terms "Lead-Free" or "Pb-Free" mean semiconductor products that are compatible with the current RoHS requirements for all 6 substances, including the requirement that lead not exceed 0.1% by weight in homogeneous materials. Where designed to be soldered at high temperatures, TI Pb-Free products are suitable for use in specified lead-free processes.

**Pb-Free (RoHS Exempt):** This component has a RoHS exemption for either 1) lead-based flip-chip solder bumps used between the die and package, or 2) lead-based die adhesive used between the die and leadframe. The component is otherwise considered Pb-Free (RoHS compatible) as defined above.

**Green (RoHS & no Sb/Br):** TI defines "Green" to mean Pb-Free (RoHS compatible), and free of Bromine (Br) and Antimony (Sb) based flame retardants (Br or Sb do not exceed 0.1% by weight in homogeneous material)

(3) MSL, Peak Temp. - The Moisture Sensitivity Level rating according to the JEDEC industry standard classifications, and peak solder temperature.

(4) There may be additional marking, which relates to the logo, the lot trace code information, or the environmental category on the device.

<sup>(5)</sup> Multiple Device Markings will be inside parentheses. Only one Device Marking contained in parentheses and separated by a "~" will appear on a device. If a line is indented then it is a continuation of the previous line and the two combined represent the entire Device Marking for that device.

<sup>(6)</sup> Lead/Ball Finish - Orderable Devices may have multiple material finish options. Finish options are separated by a vertical ruled line. Lead/Ball Finish values may wrap to two lines if the finish value exceeds the maximum column width.

**Important Information and Disclaimer:** The information provided on this page represents TI's knowledge and belief as of the date that it is provided. TI bases its knowledge and belief on information provided by third parties, and makes no representation or warranty as to the accuracy of such information. Efforts are underway to better integrate information from third parties. TI has taken and continues to take reasonable steps to provide representative and accurate information but may not have conducted destructive testing or chemical analysis on incoming materials and chemicals. TI and TI suppliers consider certain information to be proprietary, and thus CAS numbers and other limited information may not be available for release.

In no event shall TI's liability arising out of such information exceed the total purchase price of the TI part(s) at issue in this document sold by TI to Customer on an annual basis.

## TAPE AND REEL INFORMATION



### QUADRANT ASSIGNMENTS FOR PIN 1 ORIENTATION IN TAPE



\*All dimensions are nominal

Device	Package Type	Package Drawing	Pins	SPQ	Reel Diameter (mm)	Reel Width W1 (mm)	A0 (mm)	B0 (mm)	K0 (mm)	P1 (mm)	W (mm)	Pin1 Quadrant
LMC660AIMX	SOIC	D	14	2500	330.0	16.4	6.5	9.35	2.3	8.0	16.0	Q1
LMC660AIMX/NOPB	SOIC	D	14	2500	330.0	16.4	6.5	9.35	2.3	8.0	16.0	Q1
LMC660CMX/NOPB	SOIC	D	14	2500	330.0	16.4	6.5	9.35	2.3	8.0	16.0	Q1

**TAPE AND REEL BOX DIMENSIONS**

\*All dimensions are nominal



Device	Package Type	Package Drawing	Pins	SPQ	Length (mm)	Width (mm)	Height (mm)
LMC660AIMX	SOIC	D	14	2500	367.0	367.0	35.0
LMC660AIMX/NOPB	SOIC	D	14	2500	367.0	367.0	35.0
LMC660CMX/NOPB	SOIC	D	14	2500	367.0	367.0	35.0

D (R-PDSO-G14)

PLASTIC SMALL OUTLINE



4040047-5/M 06/11

- NOTES:
- A. All linear dimensions are in inches (millimeters).
  - B. This drawing is subject to change without notice.
  -  Body length does not include mold flash, protrusions, or gate burrs. Mold flash, protrusions, or gate burrs shall not exceed 0.006 (0,15) each side.
  -  Body width does not include interlead flash. Interlead flash shall not exceed 0.017 (0,43) each side.
  - E. Reference JEDEC MS-012 variation AB.

D (R-PDSO-G14)

PLASTIC SMALL OUTLINE



- NOTES:
- A. All linear dimensions are in millimeters.
  - B. This drawing is subject to change without notice.
  - C. Publication IPC-7351 is recommended for alternate designs.
  - D. Laser cutting apertures with trapezoidal walls and also rounding corners will offer better paste release. Customers should contact their board assembly site for stencil design recommendations. Refer to IPC-7525 for other stencil recommendations.
  - E. Customers should contact their board fabrication site for solder mask tolerances between and around signal pads.

N0014A

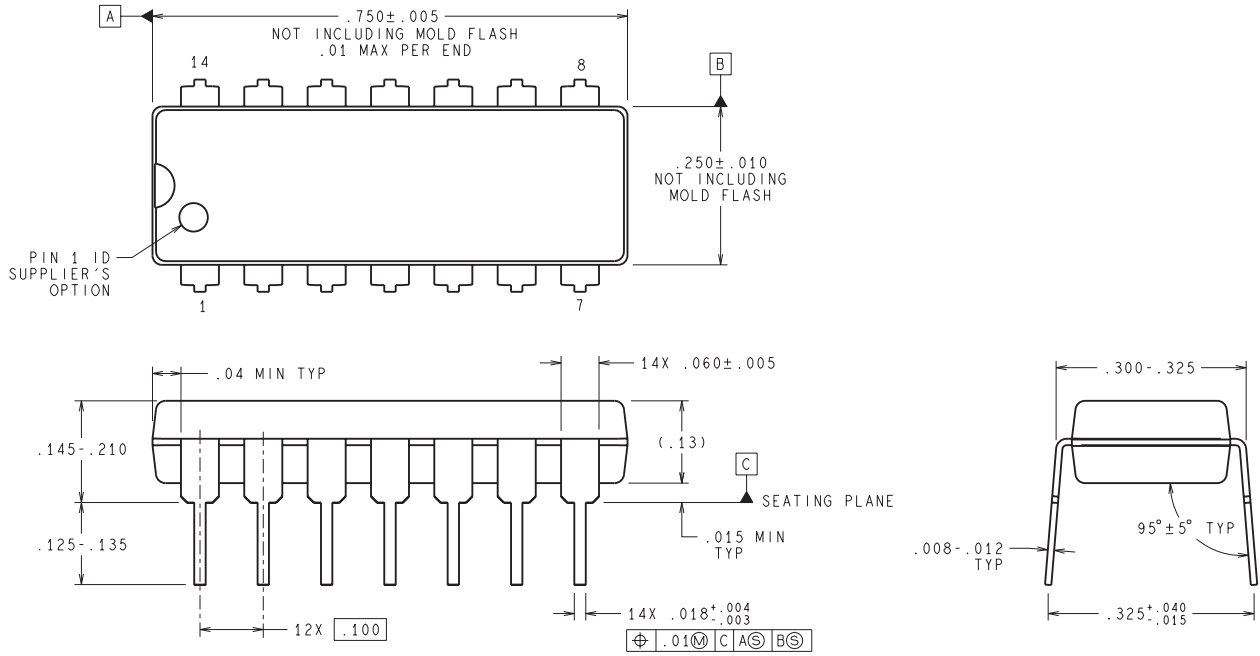

DIMENSIONS ARE IN INCHES  
DIMENSIONS IN ( ) FOR REFERENCE ONLY

N14A (Rev G)

## IMPORTANT NOTICE AND DISCLAIMER

TI PROVIDES TECHNICAL AND RELIABILITY DATA (INCLUDING DATASHEETS), DESIGN RESOURCES (INCLUDING REFERENCE DESIGNS), APPLICATION OR OTHER DESIGN ADVICE, WEB TOOLS, SAFETY INFORMATION, AND OTHER RESOURCES "AS IS" AND WITH ALL FAULTS, AND DISCLAIMS ALL WARRANTIES, EXPRESS AND IMPLIED, INCLUDING WITHOUT LIMITATION ANY IMPLIED WARRANTIES OF MERCHANTABILITY, FITNESS FOR A PARTICULAR PURPOSE OR NON-INFRINGEMENT OF THIRD PARTY INTELLECTUAL PROPERTY RIGHTS.

These resources are intended for skilled developers designing with TI products. You are solely responsible for (1) selecting the appropriate TI products for your application, (2) designing, validating and testing your application, and (3) ensuring your application meets applicable standards, and any other safety, security, or other requirements. These resources are subject to change without notice. TI grants you permission to use these resources only for development of an application that uses the TI products described in the resource. Other reproduction and display of these resources is prohibited. No license is granted to any other TI intellectual property right or to any third party intellectual property right. TI disclaims responsibility for, and you will fully indemnify TI and its representatives against, any claims, damages, costs, losses, and liabilities arising out of your use of these resources.

TI's products are provided subject to TI's Terms of Sale ([www.ti.com/legal/termsofsale.html](http://www.ti.com/legal/termsofsale.html)) or other applicable terms available either on [ti.com](http://ti.com) or provided in conjunction with such TI products. TI's provision of these resources does not expand or otherwise alter TI's applicable warranties or warranty disclaimers for TI products.

Mailing Address: Texas Instruments, Post Office Box 655303, Dallas, Texas 75265  
Copyright © 2019, Texas Instruments Incorporated

## Looking for pricing, stock, or lifecycle information?

Click below to explore more details on WIN SOURCE:

- ⊖ [View LMC660AIMX/NOPB on WIN SOURCE](#)
- ⊖ [Texas Instruments](#) Information

## Optimize Your Supply Chain with WIN SOURCE Solutions

- ✓ Global Sourcing Solution
- ✓ Obsolete Management
- ✓ Cost Control Management
- ✓ Shortage Management
- ✓ Alternative Solution
- ✓ Excess Inventory Management