



## LMC6482 CMOS Dual Rail-to-Rail Input and Output Operational Amplifier

### 1 Features

- Typical Unless Otherwise Noted
- Rail-to-Rail Input Common-Mode Voltage Range (Ensured Over Temperature)
- Rail-to-Rail Output Swing (Within 20-mV of Supply Rail, 100-k $\Omega$  Load)
- Ensured 3-V, 5-V, and 15-V Performance
- Excellent CMRR and PSRR: 82 dB
- Ultralow Input Current: 20 fA
- High Voltage Gain ( $R_L = 500\text{ k}\Omega$ ): 130 dB
- Specified for 2-k $\Omega$  and 600- $\Omega$  Loads
- Power-Good Output
- Available in VSSOP Package

### 2 Applications

- Data Acquisition Systems
- Transducer Amplifiers
- Hand-held Analytic Instruments
- Medical Instrumentation
- Active Filter, Peak Detector, Sample and Hold, pH Meter, Current Source
- Improved Replacement for TLC272, TLC277

### 3 Description

The LMC6482 device provides a common-mode range that extends to both supply rails. This rail-to-rail performance combined with excellent accuracy, due to a high CMRR, makes it unique among rail-to-rail input amplifiers. The device is ideal for systems, such as data acquisition, that require a large input signal range. The LMC6482 is also an excellent upgrade for circuits using limited common-mode range amplifiers such as the TLC272 and TLC277.

Maximum dynamic signal range is assured in low voltage and single supply systems by the rail-to-rail output swing of the LMC6482. The rail-to-rail output swing is ensured for loads down to 600  $\Omega$  of the device. Ensured low-voltage characteristics and low-power dissipation make the LMC6482 especially well-suited for battery-operated systems. LMC6482 is also available in a VSSOP package, which is almost half the size of a SOIC-8 device. See the LMC6484 data sheet for a quad CMOS operational amplifier with these same features.

#### Device Information<sup>(1)</sup>

| PART NUMBER | PACKAGE   | BODY SIZE (NOM)   |
|-------------|-----------|-------------------|
| LMC6482     | SOIC (8)  | 4.90 mm x 3.91 mm |
|             | VSSOP (8) | 3.00 mm x 3.00 mm |
|             | PDIP (8)  | 9.81 mm x 6.35 mm |

(1) For all available packages, see the orderable addendum at the end of the data sheet.

**Rail-to-Rail Input**

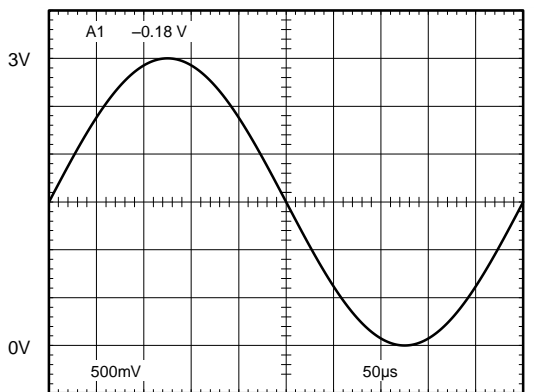

C001

**Rail-to-Rail Output**

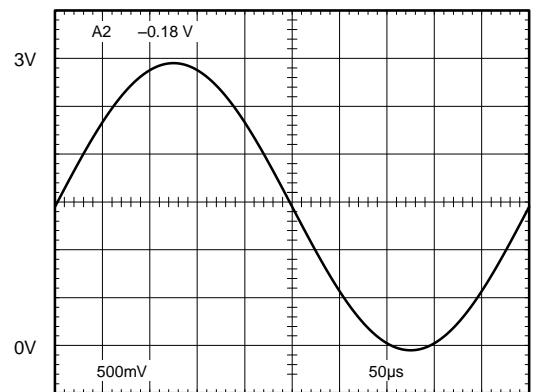

C002



## Table of Contents

|   |           |  |           |
|---|-----------|--|-----------|
| <b>1 Features</b> .....                                     | <b>1</b>  | 7.2 Functional Block Diagram .....                               | <b>18</b> |
| <b>2 Applications</b> .....                                 | <b>1</b>  | 7.3 Feature Description .....                                    | <b>18</b> |
| <b>3 Description</b> .....                                  | <b>1</b>  | 7.4 Device Functional Modes .....                                | <b>19</b> |
| <b>4 Revision History</b> .....                             | <b>2</b>  | <b>8 Application and Implementation</b> .....                    | <b>20</b> |
| <b>5 Pin Configuration and Functions</b> .....              | <b>3</b>  | 8.1 Application Information .....                                | <b>20</b> |
| <b>6 Specifications</b> .....                               | <b>3</b>  | 8.2 Typical Applications .....                                   | <b>22</b> |
| 6.1 Absolute Maximum Ratings .....                          | <b>3</b>  | <b>9 Power Supply Recommendations</b> .....                      | <b>28</b> |
| 6.2 ESD Ratings .....                                       | <b>4</b>  | <b>10 Layout</b> .....   | <b>28</b> |
| 6.3 Recommended Operating Conditions .....                  | <b>4</b>  | 10.1 Layout Guidelines .....                                     | <b>28</b> |
| 6.4 Thermal Information .....                               | <b>4</b>  | 10.2 Layout Example .....  | <b>28</b> |
| 6.5 Electrical Characteristics for $V^+ = 5\text{ V}$ ..... | <b>4</b>  | <b>11 Device and Documentation Support</b> .....                 | <b>30</b> |
| 6.6 Electrical Characteristics for $V^+ = 3\text{ V}$ ..... | <b>7</b>  | 11.1 Trademarks .....  | <b>30</b> |
| 6.7 Typical Characteristics .....                           | <b>9</b>  | 11.2 Electrostatic Discharge Caution .....                       | <b>30</b> |
| <b>7 Detailed Description</b> .....                         | <b>18</b> | 11.3 Glossary .....  | <b>30</b> |
| 7.1 Overview .....  | <b>18</b> | <b>12 Mechanical, Packaging, and Orderable Information</b> ..... | <b>30</b> |

## 4 Revision History

NOTE: Page numbers for previous revisions may differ from page numbers in the current version.

### Changes from Revision D (March 2013) to Revision E

Page

- Added *Pin Configuration and Functions* section, *ESD Ratings* table, *Feature Description* section, *Device Functional Modes*, *Application and Implementation* section, *Power Supply Recommendations* section, *Layout* section, *Device and Documentation Support* section, and *Mechanical, Packaging, and Orderable Information* section ..... **1**

### Changes from Revision C (March 2013) to Revision D

Page

- Changed layout of National Data Sheet to TI format ..... **27**

## 5 Pin Configuration and Functions

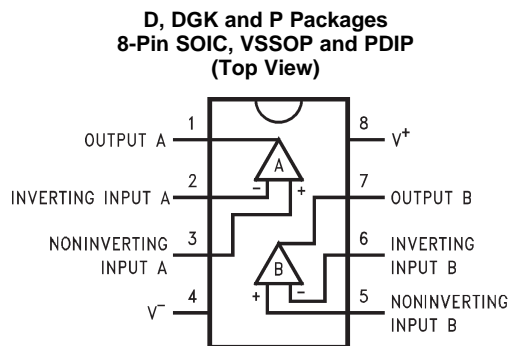

### Pin Functions

| PIN |                      | TYPE | DESCRIPTION                        |
|-----|----------------------|------|------------------------------------|
| NO. | NAME                 |      |                                    |
| 1   | OUTPUT A             | O    | Output for Amplifier A             |
| 2   | INVERTING INPUT A    | I    | Inverting input for Amplifier A    |
| 3   | NONINVERTING INPUT A | I    | Noninverting input for Amplifier A |
| 4   | V <sup>-</sup>       | P    | Negative supply voltage input      |
| 5   | NONINVERTING INPUT B | I    | Noninverting input for Amplifier B |
| 6   | INVERTING INPUT B    | I    | Inverting input for Amplifier B    |
| 7   | OUTPUT B             | O    | Output for Amplifier B             |
| 8   | V <sup>+</sup>       | P    | Positive supply voltage input      |

## 6 Specifications

### 6.1 Absolute Maximum Ratings

over operating free-air temperature range (unless otherwise noted)<sup>(1)(2)</sup>

|   | MIN                    | MAX                    | UNIT |
|---|------------------------|------------------------|------|
| Differential Input Voltage                        |                        | ±Supply Voltage        |      |
| Voltage at Input/Output Pin                       | (V <sup>-</sup> ) -0.3 | (V <sup>+</sup> ) +0.3 | V    |
| Supply Voltage (V <sup>+</sup> - V <sup>-</sup> ) |                        | 16                     | V    |
| Current at Input Pin <sup>(3)</sup>               | -5                     | 5                      | mA   |
| Current at Output Pin <sup>(4)(5)</sup>           | -30                    | 30                     | mA   |
| Current at Power Supply Pin                       |                        | 40                     | mA   |
| Lead Temperature (Soldering, 10 sec.)             |                        | 260                    | °C   |
| Junction Temperature <sup>(6)</sup>               |                        | 150                    | °C   |
| Storage temperature, T <sub>stg</sub>             | -65                    | 150                    | °C   |

- (1) Stresses beyond those listed under *Absolute Maximum Ratings* may cause permanent damage to the device. These are stress ratings only, which do not imply functional operation of the device at these or any other conditions beyond those indicated under *Recommended Operating Conditions*. Exposure to absolute-maximum-rated conditions for extended periods may affect device reliability.
- (2) If Military/Aerospace specified devices are required, please contact the TI Sales Office/Distributors for availability and specifications.
- (3) Limiting input pin current is only necessary for input voltages that exceed absolute maximum input voltage ratings.
- (4) Applies to both single-supply and split-supply operation. Continuous short circuit operation at elevated ambient temperature can result in exceeding the maximum allowed junction temperature of 150°C. Output currents in excess of ±30 mA over long term may adversely affect reliability.
- (5) Do not short circuit output to V<sup>+</sup>, when V<sup>+</sup> is greater than 13 V or reliability will be adversely affected.
- (6) The maximum power dissipation is a function of T<sub>J(max)</sub>, R<sub>θJA</sub>, and T<sub>A</sub>. The maximum allowable power dissipation at any ambient temperature is P<sub>D</sub> = (T<sub>J(max)</sub> - T<sub>A</sub>)/θ<sub>JA</sub>. All numbers apply for packages soldered directly into a PC board.

## 6.2 ESD Ratings

|             |                         | VALUE   | UNIT       |
|-------------|-------------------------|---|------------|
| $V_{(ESD)}$ | Electrostatic discharge | Human-body model (HBM), per ANSI/ESDA/JEDEC JS-001 <sup>(1)</sup> | ±1500<br>V |

(1) JEDEC document JEP155 states that 500-V HBM allows safe manufacturing with a standard ESD control process.

## 6.3 Recommended Operating Conditions

over operating free-air temperature range (unless otherwise noted)<sup>(1)</sup>

|                            |                     | MIN | MAX  | UNIT |
|----------------------------|---------------------|-----|------|------|
| Supply Voltage             |                     | 3   | 15.5 | V    |
| Junction Temperature Range | LMC6482AM           | –55 | 125  | °C   |
|                            | LMC6482AI, LMC6482I | –40 | –85  | °C   |

(1) Stresses beyond those listed under *Absolute Maximum Ratings* may cause permanent damage to the device. These are stress ratings only, which do not imply functional operation of the device at these or any other conditions beyond those indicated under *Recommended Operating Conditions*. Exposure to absolute-maximum-rated conditions for extended periods may affect device reliability.

## 6.4 Thermal Information

| THERMAL METRIC <sup>(1)</sup>                          | LMC6482  | LMC6482     | LMC6482  | UNIT |
|--|----------|-------------|----------|------|
|  | D (SOIC) | DGK (VSSOP) | P (PDIP) |      |
|  | 8 PINS   | 8 PINS      | 8 PINS   |      |
| $R_{\theta JA}$ Junction-to-ambient thermal resistance | 155      | 194         | 90       | °C/W |

(1) For more information about traditional and new thermal metrics, see the *IC Package Thermal Metrics* application report, [SPRA953](#).

## 6.5 Electrical Characteristics for $V^+ = 5\text{ V}$

Unless otherwise specified, all limits specified for  $T_J = 25^\circ\text{C}$ ,  $V^+ = 5\text{ V}$ ,  $V^- = 0\text{ V}$ ,  $V_{CM} = V_O = V^+/2$  and  $R_L > 1\text{ M}\Omega$ .

| PARAMETER                                     | TEST CONDITIONS    | $T_J = 25^\circ\text{C}$ |                    |                    | At Temperature Extremes <sup>(1)</sup> |                    |                    | UNIT                         |
|---|--------------------|--------------------------|--------------------|--------------------|--|--------------------|--------------------|------------------------------|
|   |                    | MIN                      | TYP <sup>(2)</sup> | MAX <sup>(3)</sup> | MIN                                    | TYP <sup>(2)</sup> | MAX <sup>(3)</sup> |                              |
| <b>DC Electrical Characteristics</b>          |                    |                          |                    |                    |  |                    |                    |                              |
| $V_{OS}$ Input Offset Voltage                 |                    | LMC6482AI                | 0.11               | 0.75               |  |                    | 1.35               | mV                           |
|   |                    | LMC6482I                 | 0.11               | 3                  |  |                    | 3.7                |                              |
|   |                    | LMC6482M                 | 0.11               | 3                  |  |                    | 3.8                |                              |
| $TCV_{OS}$ Input Offset Voltage Average Drift |                    |                          | 1                  |                    |  |                    |                    | $\mu\text{V}/^\circ\text{C}$ |
| $I_B$ Input Current                           | See <sup>(4)</sup> | LMC6482AI                | 0.02               |                    |  |                    | 4                  | pA                           |
|   |                    | LMC6482I                 | 0.02               |                    |  |                    | 4                  |                              |
|   |                    | LMC6482M                 | 0.02               |                    |  |                    | 10                 |                              |
| $I_{OS}$ Input Offset Current                 | See <sup>(4)</sup> | LMC6482AI                | 0.01               |                    |  |                    | 2                  | pA                           |
|   |                    | LMC6482I                 | 0.01               |                    |  |                    | 2                  |                              |
|   |                    | LMC6482M                 | 0.01               |                    |  |                    | 5                  |                              |
| $C_{IN}$ Common-Mode Input Capacitance        |                    |                          | 3                  |                    |  |                    |                    | pF                           |
| $R_{IN}$ Input Resistance                     |                    |                          | 10                 |                    |  |                    |                    | Tera $\Omega$                |

(1) See [Recommended Operating Conditions](#) for operating temperature ranges.

(2) Typical Values represent the most likely parametric norm.

(3) All limits are specified by testing or statistical analysis.

(4) Ensured limits are dictated by tester limitations and not device performance. Actual performance is reflected in the typical value.

**Electrical Characteristics for  $V^+ = 5\text{ V}$  (continued)**

Unless otherwise specified, all limits specified for  $T_J = 25^\circ\text{C}$ ,  $V^+ = 5\text{ V}$ ,  $V^- = 0\text{ V}$ ,  $V_{CM} = V_O = V^+/2$  and  $R_L > 1\text{ M}$ .

| PARAMETER                                      | TEST CONDITIONS   |           | $T_J = 25^\circ\text{C}$ |                    |                    | At Temperature Extremes <sup>(1)</sup> |                    |                    | UNIT |
|--|---|-----------|--------------------------|--------------------|--------------------|--|--------------------|--------------------|------|
|  |   |           | MIN                      | TYP <sup>(2)</sup> | MAX <sup>(3)</sup> | MIN                                    | TYP <sup>(2)</sup> | MAX <sup>(3)</sup> |      |
| CMRR<br>Common-Mode Rejection Ratio            | $0\text{ V} \leq V_{CM} \leq 15\text{ V}$<br>$V^+ = 15\text{ V}$                          | LMC6482AI | 70                       | 82                 |                    | 67                                     |                    | dB                 |      |
|  |   | LMC6482I  | 65                       | 82                 |                    | 62                                     |                    |                    |      |
|  |   | LMC6482M  | 65                       | 82                 |                    | 60                                     |                    |                    |      |
|  | $0\text{ V} \leq V_{CM} \leq 5\text{ V}$<br>$V^+ = 5\text{ V}$                            | LMC6482AI | 70                       | 82                 |                    | 67                                     |                    |                    |      |
|  |   | LMC6482I  | 65                       | 82                 |                    | 62                                     |                    |                    |      |
|  |   | LMC6482M  | 65                       | 82                 |                    | 60                                     |                    |                    |      |
| +PSRR<br>Positive Power Supply Rejection Ratio | $5\text{ V} \leq V^+ \leq 15\text{ V}$ ,<br>$V^- = 0\text{ V}$<br>$V_O = 2.5\text{ V}$    | LMC6482AI | 70                       | 82                 |                    | 67                                     |                    | dB                 |      |
|  |   | LMC6482I  | 65                       | 82                 |                    | 62                                     |                    |                    |      |
|  |   | LMC6482M  | 65                       | 82                 |                    | 60                                     |                    |                    |      |
| -PSRR<br>Negative Power Supply Rejection Ratio | $-5\text{ V} \leq V^- \leq -15\text{ V}$ ,<br>$V^+ = 0\text{ V}$<br>$V_O = -2.5\text{ V}$ | LMC6482AI | 70                       | 82                 |                    | 67                                     |                    | dB                 |      |
|  |   | LMC6482I  | 65                       | 82                 |                    | 62                                     |                    |                    |      |
|  |   | LMC6482M  | 65                       | 82                 |                    | 60                                     |                    |                    |      |
| $V_{CM}$<br>Input Common-Mode Voltage Range    | $V^+ = 5\text{ V}$ and $15\text{ V}$<br>For CMRR $\geq 50\text{ dB}$                      | LMC6482AI |                          | $V^- - 0.3$        | $-0.25$            |  | 0                  | V                  |      |
|  |   | LMC6482I  |                          | $V^- - 0.3$        | $-0.25$            |  | 0                  |                    |      |
|  |   | LMC6482M  |                          | $V^- - 0.3$        | $-0.25$            |  | 0                  |                    |      |
|  |   | LMC6482AI | $V^+ + 0.25$             | $V^+ + 0.3$        |                    | $V^+$                                  |                    | V                  |      |
|  |   | LMC6482I  | $V^+ + 0.25$             | $V^+ + 0.3$        |                    | $V^+$                                  |                    |                    |      |
|  |   | LMC6482M  | $V^+ + 0.25$             | $V^+ + 0.3$        |                    | $V^+$                                  |                    |                    |      |
| $A_V$<br>Large Signal Voltage Gain             | $R_L = 2\text{ k}\Omega$ <sup>(5)(4)</sup>  | Sourcing  | LMC6482AI                | 140                | 666                |  | 84                 | V/mV               |      |
|  |   |           | LMC6482I                 | 120                | 666                |  | 72                 |                    |      |
|  |   |           | LMC6482M                 | 120                | 666                |  | 60                 |                    |      |
|  |   | Sinking   | LMC6482AI                | 35                 | 75                 |  | 20                 | V/mV               |      |
|  |   |           | LMC6482I                 | 35                 | 75                 |  | 20                 |                    |      |
|  |   |           | LMC6482M                 | 35                 | 75                 |  | 18                 |                    |      |
|  | $R_L = 600\ \Omega$ <sup>(5)(4)</sup>   | Sourcing  | LMC6482AI                | 80                 | 300                |  | 48                 | V/mV               |      |
|  |   |           | LMC6482I                 | 50                 | 300                |  | 30                 |                    |      |
|  |   |           | LMC6482M                 | 50                 | 300                |  | 25                 |                    |      |
|  |   | Sinking   | LMC6482AI                | 20                 | 35                 |  | 13                 | V/mV               |      |
|  |   |           | LMC6482I                 | 15                 | 35                 |  | 10                 |                    |      |
|  |   |           | LMC6482M                 | 15                 | 35                 |  | 8                  |                    |      |

(5)  $V^+ = 15\text{ V}$ ,  $V_{CM} = 7.5\text{ V}$  and  $R_L$  connected to  $7.5\text{ V}$ . For Sourcing tests,  $7.5\text{ V} \leq V_O \leq 11.5\text{ V}$ . For Sinking tests,  $3.5\text{ V} \leq V_O \leq 7.5\text{ V}$ .

**Electrical Characteristics for  $V^+ = 5\text{ V}$  (continued)**

Unless otherwise specified, all limits specified for  $T_J = 25^\circ\text{C}$ ,  $V^+ = 5\text{ V}$ ,  $V^- = 0\text{ V}$ ,  $V_{CM} = V_O = V^+/2$  and  $R_L > 1\text{ M}$ .

| PARAMETER  | TEST CONDITIONS  | $T_J = 25^\circ\text{C}$                             |                    |                    | At Temperature Extremes <sup>(1)</sup> |                    |                    | UNIT |   |
|--|--|--|--------------------|--------------------|--|--------------------|--------------------|------|---|
|  |  | MIN  | TYP <sup>(2)</sup> | MAX <sup>(3)</sup> | MIN                                    | TYP <sup>(2)</sup> | MAX <sup>(3)</sup> |      |   |
| $V_O$ Output Swing   | $V^+ = 5\text{ V}$<br>$R_L = 2\text{ k}\Omega$ to $V^+/2$  | LMC6482AI  | 4.8                | 4.9                | 4.7                                    |                    | V                  |      |   |
|  |  | LMC6482I   | 4.8                | 4.9                | 4.7                                    |                    |                    |      |   |
|  |  | LMC6482M   | 4.8                | 4.9                | 4.7                                    |                    |                    |      |   |
|  |  | $V^+ = 5\text{ V}$<br>$R_L = 600\ \Omega$ to $V^+/2$ | LMC6482AI          |                    | 0.1                                    | 0.18               | 0.24               |      | V |
|  |  |  | LMC6482I           |                    | 0.1                                    | 0.18               | 0.24               |      |   |
|  |  |  | LMC6482M           |                    | 0.1                                    | 0.18               | 0.24               |      |   |
|  | $V^+ = 5\text{ V}$<br>$R_L = 600\ \Omega$ to $V^+/2$       |  | LMC6482AI          | 4.5                | 4.7                                    | 4.24               |                    | V    |   |
|  |  |  | LMC6482I           | 4.5                | 4.7                                    | 4.24               |                    |      |   |
|  |  |  | LMC6482M           | 4.5                | 4.7                                    | 4.24               |                    |      |   |
|  |  | LMC6482AI  |                    | 0.3                | 0.5                                    | 0.65               |                    |      |   |
|  |  | LMC6482I   |                    | 0.3                | 0.5                                    | 0.65               |                    |      |   |
|  |  | LMC6482M   |                    | 0.3                | 0.5                                    | 0.65               |                    |      |   |
|  | $V^+ = 15\text{ V}$<br>$R_L = 2\text{ k}\Omega$ to $V^+/2$ | LMC6482AI  | 14.4               | 14.7               | 14.2                                   |                    | V                  |      |   |
|  |  | LMC6482I   | 14.4               | 14.7               | 14.2                                   |                    |                    |      |   |
|  |  | LMC6482M   | 14.4               | 14.7               | 14.2                                   |                    |                    |      |   |
|  |  | LMC6482AI  |                    | 0.16               | 0.32                                   | 0.45               |                    |      |   |
|  |  | LMC6482I   |                    | 0.16               | 0.32                                   | 0.45               |                    |      |   |
|  |  | LMC6482M   |                    | 0.16               | 0.32                                   | 0.45               |                    |      |   |
|  | $V^+ = 15\text{ V}$<br>$R_L = 600\ \Omega$ to $V^+/2$      | LMC6482AI  | 13.4               | 14.1               | 13                                     |                    | V                  |      |   |
|  |  | LMC6482I   | 13.4               | 14.1               | 13                                     |                    |                    |      |   |
|  |  | LMC6482M   | 13.4               | 14.1               | 13                                     |                    | V                  |      |   |
|  |  | LMC6482AI  |                    | 0.5                | 1                                      | 1.3                |                    |      |   |
|  |  | LMC6482I   |                    | 0.5                | 1                                      | 1.3                |                    |      |   |
|  |  | LMC6482M   |                    | 0.5                | 1                                      | 1.3                |                    |      |   |
| $I_{SC}$ Output Short Circuit Current<br>$V^+ = 5\text{ V}$  | Sourcing, $V_O = 0\text{ V}$                               | LMC6482AI  | 16                 | 20                 | 12                                     |                    | mA                 |      |   |
|  |  | LMC6482I   | 16                 | 20                 | 12                                     |                    |                    |      |   |
|  |  | LMC6482M   | 16                 | 20                 | 10                                     |                    |                    |      |   |
|  | Sinking, $V_O = 5\text{ V}$                                | LMC6482AI  | 11                 | 15                 | 9.5                                    |                    | mA                 |      |   |
|  |  | LMC6482I   | 11                 | 15                 | 9.5                                    |                    |                    |      |   |
|  |  | LMC6482M   | 11                 | 15                 | 8                                      |                    |                    |      |   |
| $I_{SC}$ Output Short Circuit Current<br>$V^+ = 15\text{ V}$ | Sourcing, $V_O = 0\text{ V}$                               | LMC6482AI  | 28                 | 30                 | 22                                     |                    | mA                 |      |   |
|  |  | LMC6482I   | 28                 | 30                 | 22                                     |                    |                    |      |   |
|  |  | LMC6482M   | 28                 | 30                 | 20                                     |                    |                    |      |   |
|  | Sinking, $V_O = 12\text{ V}$ <sup>(6)</sup>                | LMC6482AI  | 30                 | 30                 | 24                                     |                    | mA                 |      |   |
|  |  | LMC6482I   | 30                 | 30                 | 24                                     |                    |                    |      |   |
|  |  | LMC6482M   | 30                 | 30                 | 22                                     |                    |                    |      |   |
| $I_S$ Supply Current   | Both Amplifiers<br>$V^+ = +5\text{ V}$ ,<br>$V_O = V^+/2$  | LMC6482AI  |                    | 1                  | 1.4                                    | 1.8                |                    | mA   |   |
|  |  | LMC6482I   |                    | 1                  | 1.4                                    | 1.8                |                    |      |   |
|  |  | LMC6482M   |                    | 1                  | 1.4                                    | 1.9                |                    |      |   |
|  | Both Amplifiers<br>$V^+ = 15\text{ V}$ ,<br>$V_O = V^+/2$  | LMC6482AI  |                    | 1.3                | 1.6                                    | 1.9                |                    | mA   |   |
|  |  | LMC6482I   |                    | 1.3                | 1.6                                    | 1.9                |                    |      |   |
|  |  | LMC6482M   |                    | 1.3                | 1.6                                    | 2                  |                    |      |   |

(6) Do not short circuit output to  $V^+$ , when  $V^+$  is greater than 13 V or reliability will be adversely affected.

## Electrical Characteristics for $V^+ = 5\text{ V}$ (continued)

Unless otherwise specified, all limits specified for  $T_J = 25^\circ\text{C}$ ,  $V^+ = 5\text{ V}$ ,  $V^- = 0\text{ V}$ ,  $V_{CM} = V_O = V^+/2$  and  $R_L > 1\text{ M}$ .

| PARAMETER                            | TEST CONDITIONS              | $T_J = 25^\circ\text{C}$  |                    |                    | At Temperature Extremes <sup>(1)</sup> |                    |                    | UNIT                         |                        |
|--------------------------------------|------------------------------|---|--------------------|--------------------|--|--------------------|--------------------|------------------------------|------------------------|
|                                      |                              | MIN   | TYP <sup>(2)</sup> | MAX <sup>(3)</sup> | MIN                                    | TYP <sup>(2)</sup> | MAX <sup>(3)</sup> |                              |                        |
| <b>AC Electrical Characteristics</b> |                              |   |                    |                    |  |                    |                    |                              |                        |
| SR                                   | Slew Rate                    | See <sup>(7)</sup>  | LMC6482AI          | 1                  | 1.3                                    | 0.7                |                    |                              | $\text{V}/\mu\text{s}$ |
|                                      |                              |   | LMC6482I           | 0.9                | 1.3                                    | 0.63               |                    |                              | $\text{V}/\mu\text{s}$ |
|                                      |                              |   | LMC6482M           | 0.9                | 1.3                                    | 0.54               |                    |                              | $\text{V}/\mu\text{s}$ |
| GBW                                  | Gain-Bandwidth Product       | $V^+ = 15\text{ V}$   |                    | 1.5                |  |                    |                    | MHz                          |                        |
| $\phi_m$                             | Phase Margin                 |   |                    | 50                 |  |                    |                    | Deg                          |                        |
| $G_m$                                | Gain Margin                  |   |                    | 15                 |  |                    |                    | dB                           |                        |
|                                      | Amp-to-Amp Isolation         | See <sup>(8)</sup>  |                    | 150                |  |                    |                    | dB                           |                        |
| $e_n$                                | Input-Referred Voltage Noise | $F = 1\text{ kHz}$<br>$V_{cm} = 1\text{ V}$   |                    | 37                 |  |                    |                    | $\text{nV}/\sqrt{\text{Hz}}$ |                        |
| $I_n$                                | Input-Referred Current Noise | $F = 1\text{ kHz}$  |                    | 0.03               |  |                    |                    | $\text{pA}/\sqrt{\text{Hz}}$ |                        |
| T.H.D.                               | Total Harmonic Distortion    | $F = 10\text{ kHz}$ , $A_V = -2$<br>$R_L = 10\text{ k}\Omega$ ,<br>$V_O = 4.1\text{ V}_{PP}$                        |                    | 0.01%              |  |                    |                    |                              |                        |
|                                      |                              | $F = 10\text{ kHz}$ , $A_V = -2$<br>$R_L = 10\text{ k}\Omega$ ,<br>$V_O = 8.5\text{ V}_{PP}$<br>$V^+ = 10\text{ V}$ |                    | 0.01%              |  |                    |                    |                              |                        |

(7)  $V^+ = 15\text{ V}$ . Connected as Voltage Follower with 10V step input. Number specified is the slower of either the positive or negative slew rates.

(8) Input referred,  $V^+ = 15\text{ V}$  and  $R_L = 100\text{ k}\Omega$  connected to 7.5 V. Each amp excited in turn with 1 kHz to produce  $V_O = 12\text{ V}_{PP}$ .

## 6.6 Electrical Characteristics for $V^+ = 3\text{ V}$

Unless otherwise specified, all limits specified for  $T_J = 25^\circ\text{C}$ ,  $V^+ = 3\text{ V}$ ,  $V^- = 0\text{ V}$ ,  $V_{CM} = V_O = V^+/2$  and  $R_L > 1\text{ M}$ .

| PARAMETER                            | TEST CONDITIONS                    | $T_J = 25^\circ\text{C}$                 |                    |                    | At Temperature Extremes <sup>(1)</sup> |                    |                    | UNIT                         |
|--------------------------------------|------------------------------------|--|--------------------|--------------------|--|--------------------|--------------------|------------------------------|
|                                      |                                    | MIN                                      | TYP <sup>(2)</sup> | MAX <sup>(3)</sup> | MIN                                    | TYP <sup>(2)</sup> | MAX <sup>(3)</sup> |                              |
| <b>DC Electrical Characteristics</b> |                                    |  |                    |                    |  |                    |                    |                              |
| $V_{OS}$                             | Input Offset Voltage               |  | LMC6482AI          | 0.9                | 2                                      | 2.7                |                    | mV                           |
|                                      |                                    |  | LMC6482I           | 0.9                | 3                                      | 3.7                |                    |                              |
|                                      |                                    |  | LMC6482M           | 0.9                | 3                                      | 3.8                |                    |                              |
| $TCV_{OS}$                           | Input Offset Voltage Average Drift |  |                    | 2                  |  |                    |                    | $\mu\text{V}/^\circ\text{C}$ |
| $I_B$                                | Input Bias Current                 |  |                    | 0.02               |  |                    |                    | pA                           |
| $I_{OS}$                             | Input Offset Current               |  |                    | 0.01               |  |                    |                    | pA                           |
| CMRR                                 | Common Mode Rejection Ratio        | $0\text{ V} \leq V_{CM} \leq 3\text{ V}$ | LMC6482AI          | 64                 | 74                                     |                    |                    | dB                           |
|                                      |                                    |  | LMC6482I           | 60                 | 74                                     |                    |                    |                              |
|                                      |                                    |  | LMC6482M           | 60                 | 74                                     |                    |                    |                              |

(1) See [Recommended Operating Conditions](#) for operating temperature ranges.

(2) Typical Values represent the most likely parametric norm.

(3) All limits are specified by testing or statistical analysis.

**Electrical Characteristics for  $V^+ = 3\text{ V}$  (continued)**

 Unless otherwise specified, all limits specified for  $T_J = 25^\circ\text{C}$ ,  $V^+ = 3\text{ V}$ ,  $V^- = 0\text{ V}$ ,  $V_{CM} = V_O = V^+/2$  and  $R_L > 1\text{ M}$ .

| PARAMETER                                   | TEST CONDITIONS  | $T_J = 25^\circ\text{C}$  |                    |                    | At Temperature Extremes <sup>(1)</sup> |                    |                    | UNIT             |
|---|--|---|--------------------|--------------------|--|--------------------|--------------------|------------------|
|   |  | MIN   | TYP <sup>(2)</sup> | MAX <sup>(3)</sup> | MIN                                    | TYP <sup>(2)</sup> | MAX <sup>(3)</sup> |                  |
| PSRR<br>Power Supply Rejection Ratio        | $3\text{ V} \leq V^+ \leq 15\text{ V}$ ,<br>$V^- = 0\text{ V}$ | LMC6482AI   | 68                 | 80                 |  |                    |                    | dB               |
|   |  | LMC6482I  | 60                 | 80                 |  |                    |                    |                  |
|   |  | LMC6482M  | 60                 | 80                 |  |                    |                    |                  |
| $V_{CM}$<br>Input Common-Mode Voltage Range | For CMRR $\geq 50$ dB  | LMC6482AI   |                    | $V^- - 0.25$       | 0                                      |                    |                    | V                |
|   |  | LMC6482I  |                    | $V^- - 0.25$       | 0                                      |                    |                    |                  |
|   |  | LMC6482M  |                    | $V^- - 0.25$       | 0                                      |                    |                    |                  |
|   |  | LMC6482AI   | $V^+$              | $V^+ + 0.25$       |  |                    |                    | V                |
|   |  | LMC6482I  | $V^+$              | $V^+ + 0.25$       |  |                    |                    |                  |
|   |  | LMC6482M  | $V^+$              | $V^+ + 0.25$       |  |                    |                    |                  |
| $V_O$<br>Output Swing                       | $R_L = 2\text{ k}\Omega$ to $V^+/2$                            |   |                    | 2.8                |  |                    | V                  |                  |
|   |  |   |                    | 0.2                |  |                    | V                  |                  |
|   | $R_L = 600\ \Omega$ to $V^+/2$                                 | LMC6482AI   | 2.5                | 2.7                |  |                    |                    | V                |
|   |  | LMC6482I  | 2.5                | 2.7                |  |                    |                    |                  |
|   |  | LMC6482M  | 2.5                | 2.7                |  |                    |                    |                  |
|   |  | LMC6482AI   |                    | 0.37               | 0.6                                    |                    |                    | V                |
|   |  | LMC6482I  |                    | 0.37               | 0.6                                    |                    |                    |                  |
|   |  | LMC6482M  |                    | 0.37               | 0.6                                    |                    |                    |                  |
| $I_S$<br>Supply Current                     | Both Amplifiers  | LMC6482AI   | 0.825              | 1.2                |  |                    | 1.5                | mA               |
|   |  | LMC6482I  | 0.825              | 1.2                |  |                    | 1.5                |                  |
|   |  | LMC6482M  | 0.825              | 1.2                |  |                    | 1.6                |                  |
| <b>AC Electrical Characteristics</b>        |  |   |                    |                    |  |                    |                    |                  |
| SR  | Slew Rate  | See <sup>(4)</sup>  |                    | 0.9                |  |                    |                    | V/ $\mu\text{s}$ |
| GBW   | Gain-Bandwidth Product   |   |                    | 1                  |  |                    |                    | MHz              |
| T.H.D.                                      | Total Harmonic Distortion                                      | $F = 10\text{ kHz}$ , $A_V = -2$<br>$R_L = 10\text{ k}\Omega$ , $V_O = 2\text{ V}_{PP}$ |                    | 0.01%              |  |                    |                    |                  |

(4) Connected as voltage Follower with 2-V step input. Number specified is the slower of either the positive or negative slew rates.

### 6.7 Typical Characteristics

$V_S = 15\text{ V}$ , Single Supply,  $T_A = 25^\circ\text{C}$  unless otherwise specified

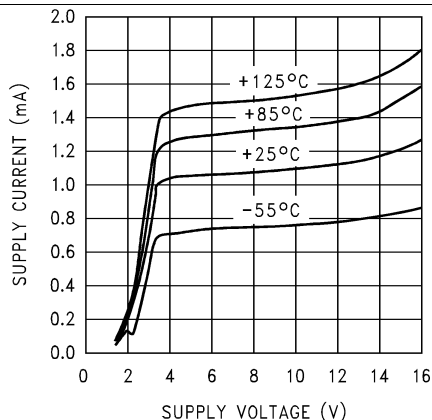

Figure 1. Supply Current vs. Supply Voltage

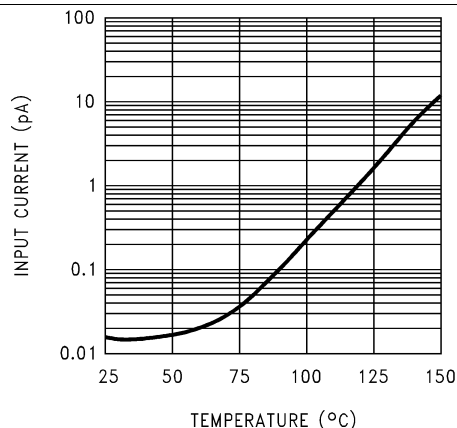

Figure 2. Input Current vs. Temperature

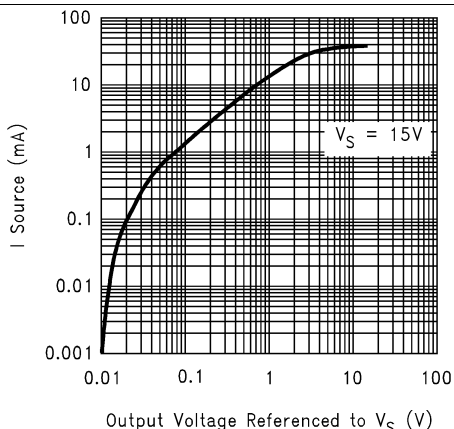

Figure 3. Sourcing Current vs. Output Voltage

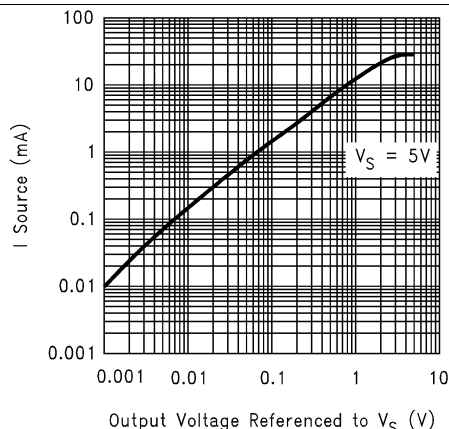

Figure 4. Sourcing Current vs. Output Voltage

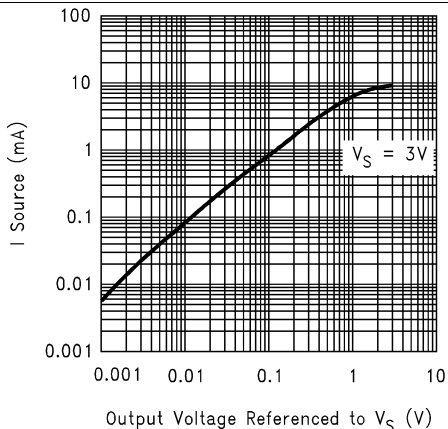

Figure 5. Sourcing Current vs. Output Voltage

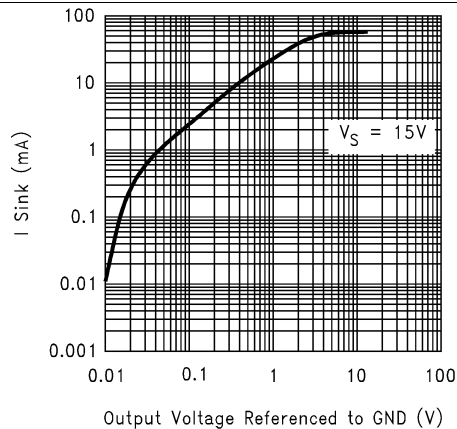
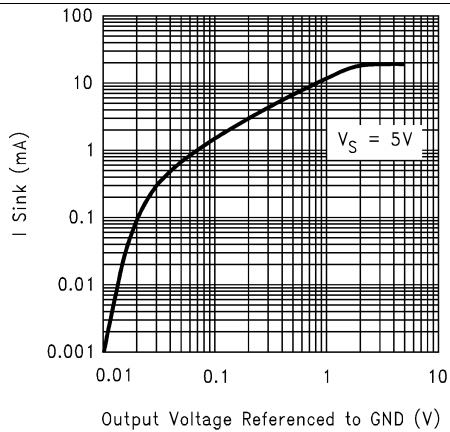

Figure 6. Sinking Current vs. Output Voltage

### Typical Characteristics (continued)

$V_S = 15\text{ V}$ , Single Supply,  $T_A = 25^\circ\text{C}$  unless otherwise specified



**Figure 7. Sinking Current vs. Output Voltage**

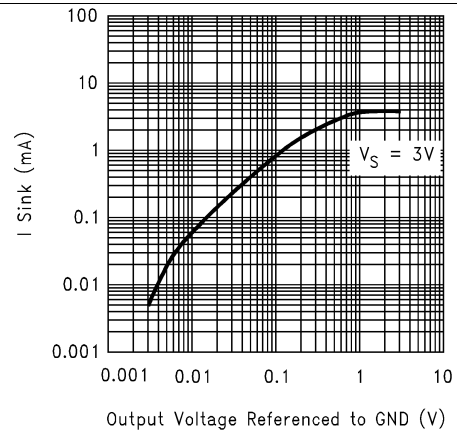

**Figure 8. Sinking Current vs. Output Voltage**

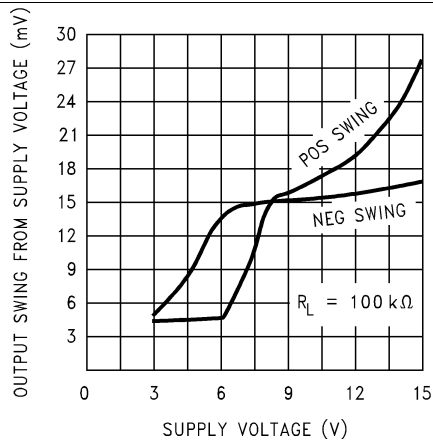

**Figure 9. Output Voltage Swing vs. Supply Voltage**

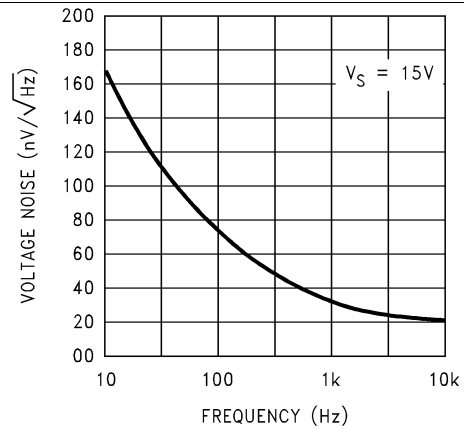

**Figure 10. Input Voltage Noise vs. Frequency**

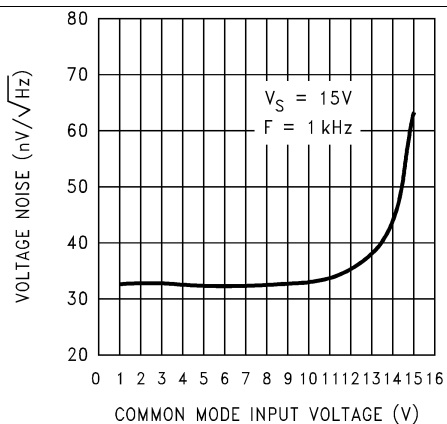

**Figure 11. Input Voltage Noise vs. Input Voltage**

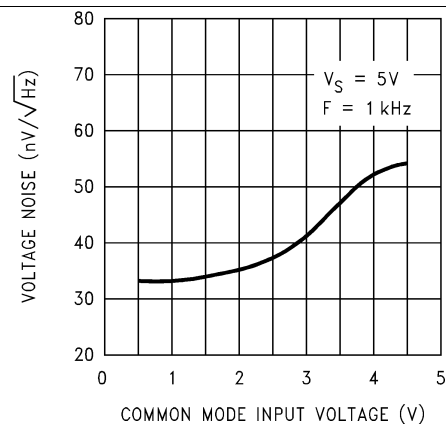

**Figure 12. Input Voltage Noise vs. Input Voltage**

Typical Characteristics (continued)

$V_S = 15\text{ V}$ , Single Supply,  $T_A = 25^\circ\text{C}$  unless otherwise specified

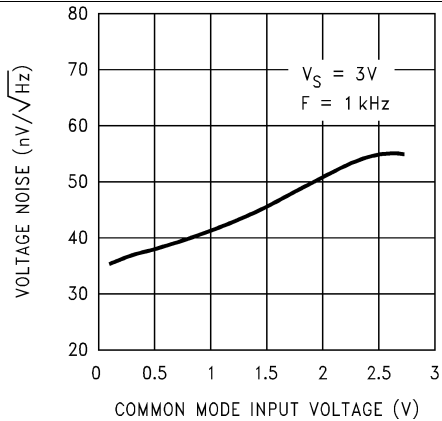

Figure 13. Input Voltage Noise vs. Input Voltage

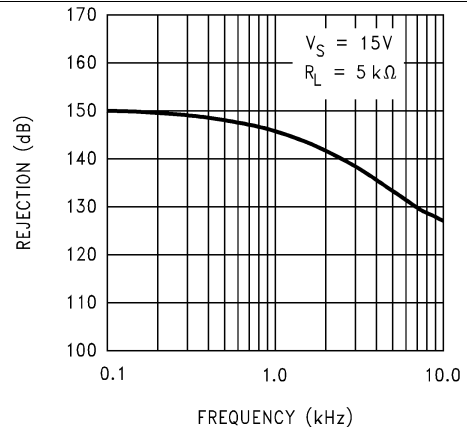

Figure 14. Crosstalk Rejection vs. Frequency

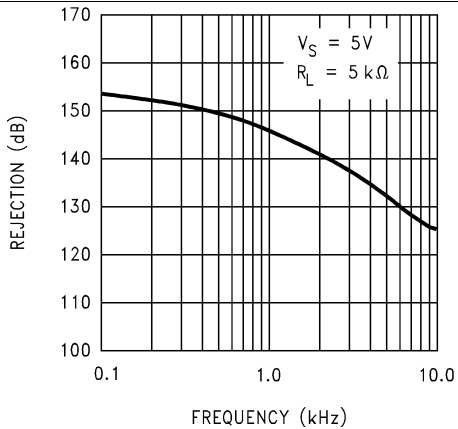

Figure 15. Crosstalk Rejection vs. Frequency

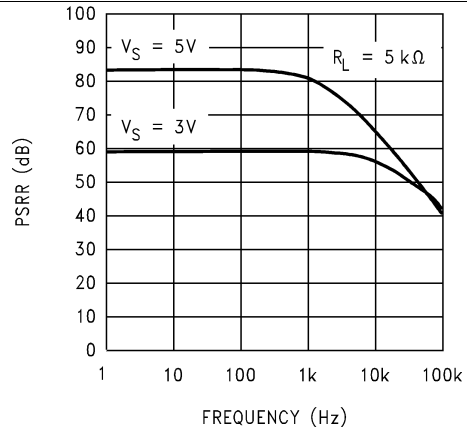

Figure 16. Positive PSRR vs. Frequency

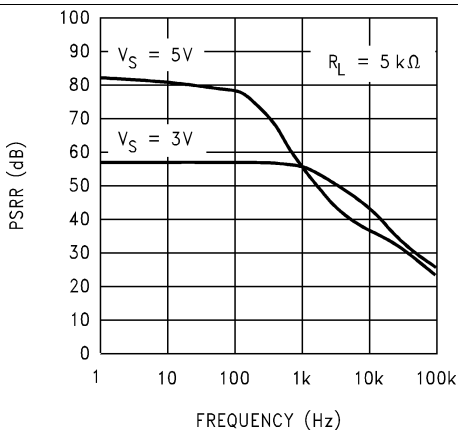

Figure 17. Negative PSRR vs. Frequency

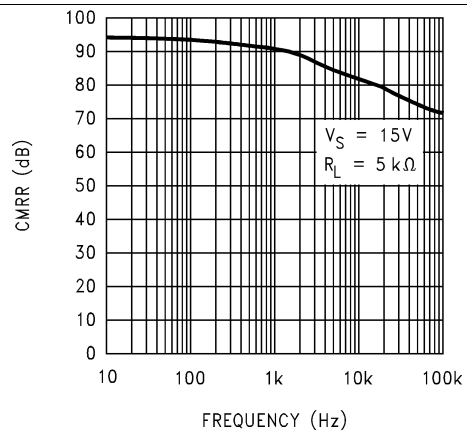

Figure 18. CMRR vs. Frequency

Typical Characteristics (continued)

$V_S = 15\text{ V}$ , Single Supply,  $T_A = 25^\circ\text{C}$  unless otherwise specified

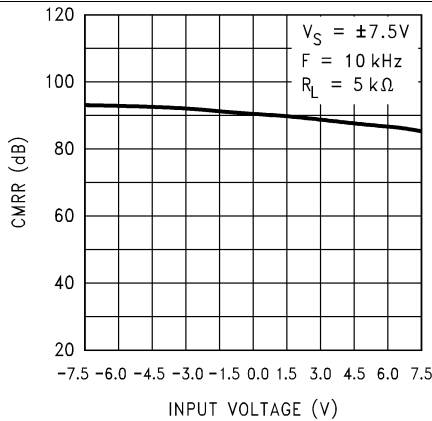

Figure 19. CMRR vs. Input Voltage

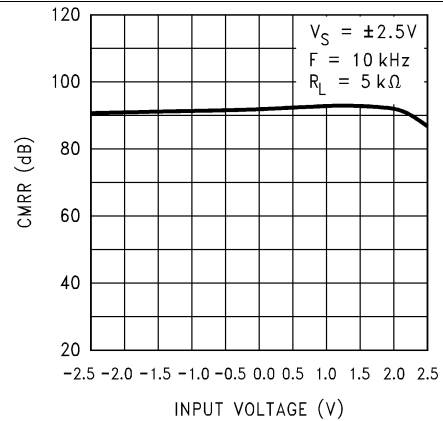

Figure 20. CMRR vs. Input Voltage

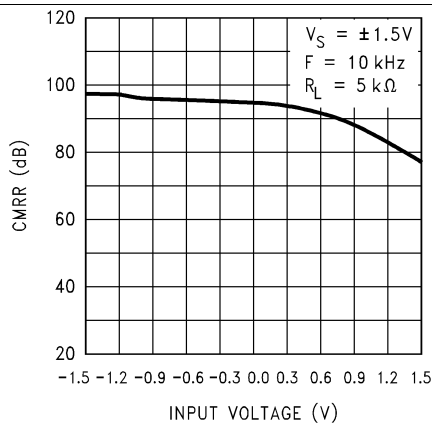

Figure 21. CMRR vs. Input Voltage

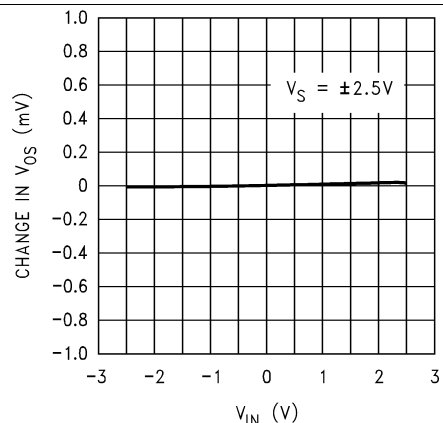

Figure 22.  $\Delta V_{OS}$  vs. CMR

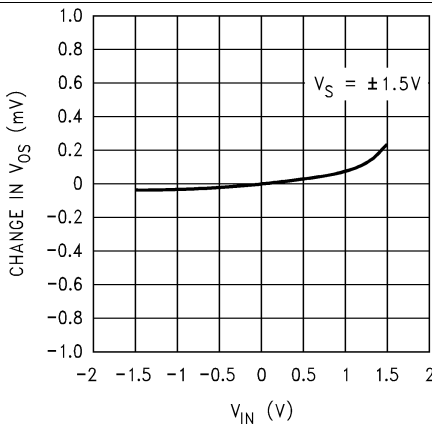

Figure 23.  $\Delta V_{OS}$  vs. CMR

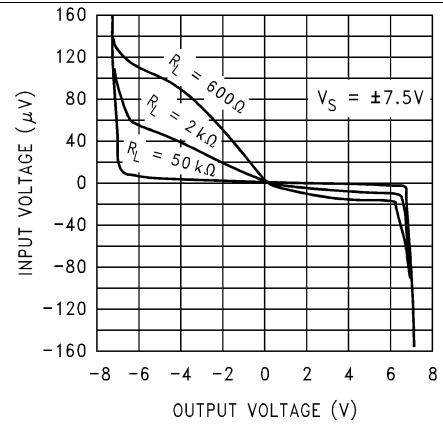

Figure 24. Input Voltage vs. Output Voltage

Typical Characteristics (continued)

$V_S = 15\text{ V}$ , Single Supply,  $T_A = 25^\circ\text{C}$  unless otherwise specified

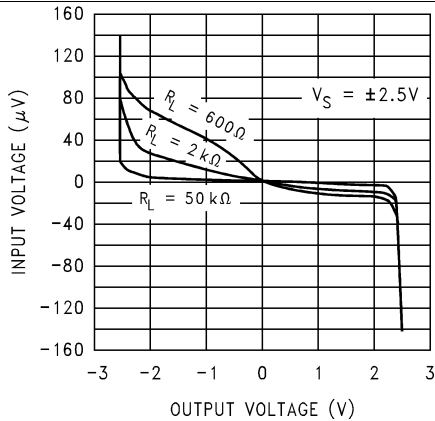

Figure 25. Input Voltage vs. Output Voltage

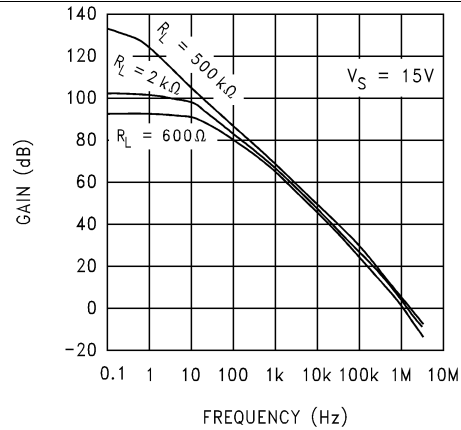

Figure 26. Open-Loop Frequency Response

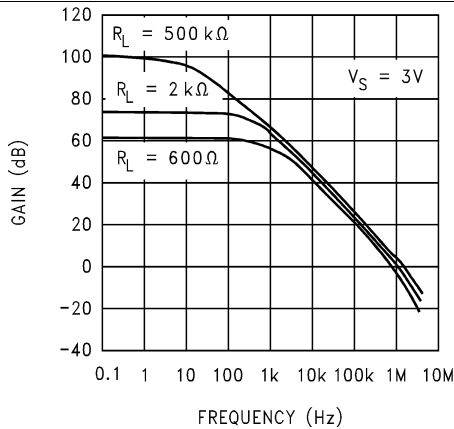

Figure 27. Open-Loop Frequency Response

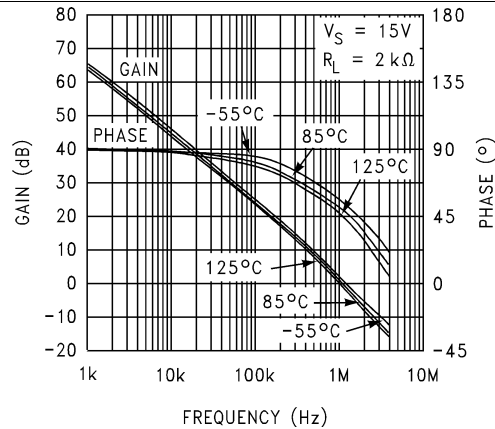

Figure 28. Open-Loop Frequency Response vs. Temperature

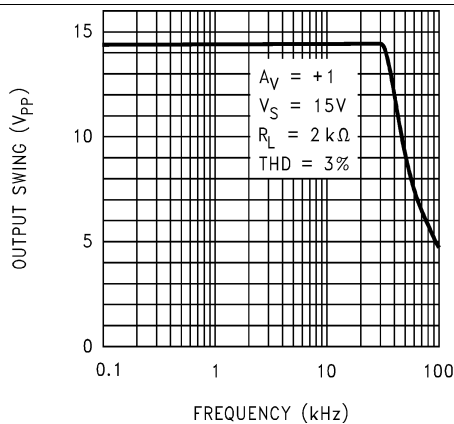

Figure 29. Maximum Output Swing vs. Frequency

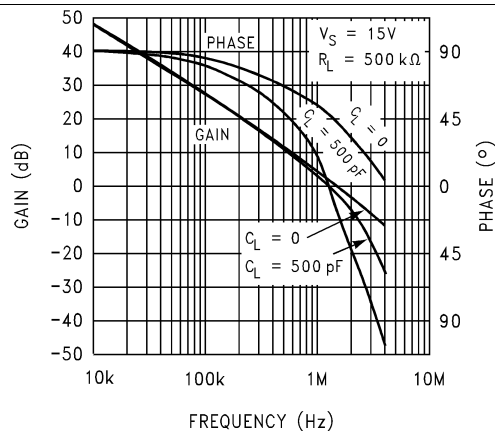
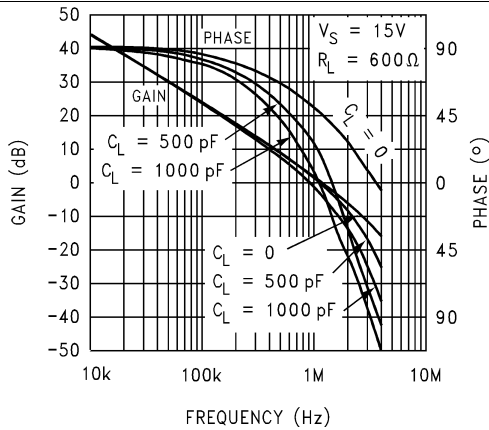

Figure 30. Gain and Phase vs. Capacitive Load

**Typical Characteristics (continued)**

$V_S = 15\text{ V}$ , Single Supply,  $T_A = 25^\circ\text{C}$  unless otherwise specified



**Figure 31. Gain and Phase vs. Capacitive Load**

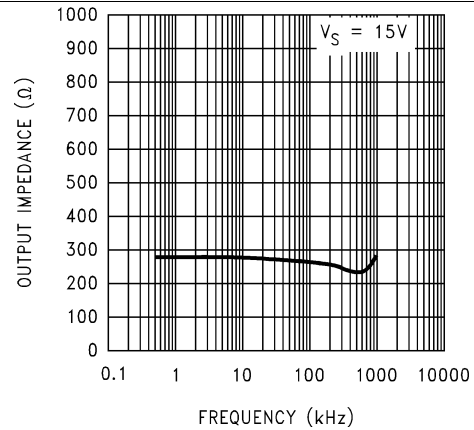

**Figure 32. Open-Loop Output Impedance vs. Frequency**

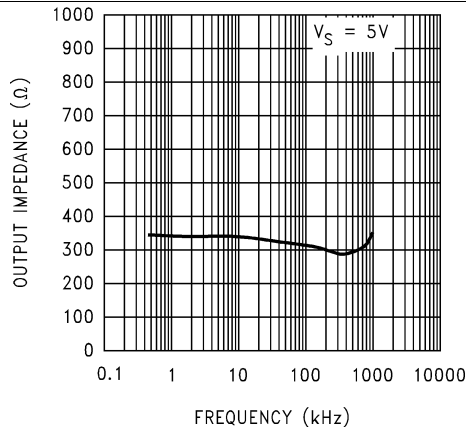

**Figure 33. Open-Loop Output Impedance vs. Frequency**

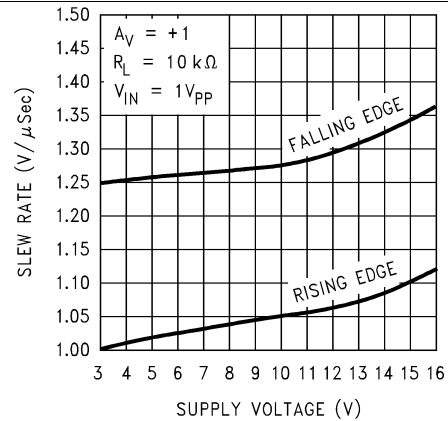

**Figure 34. Slew Rate vs. Supply Voltage**

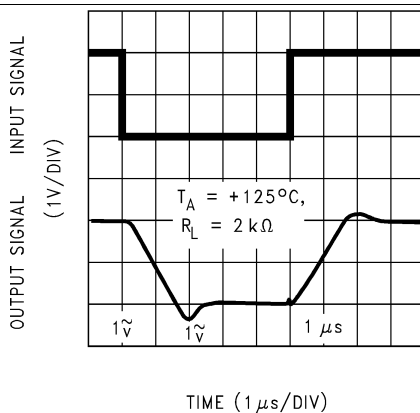

**Figure 35. Noninverting Large Signal Pulse Response**

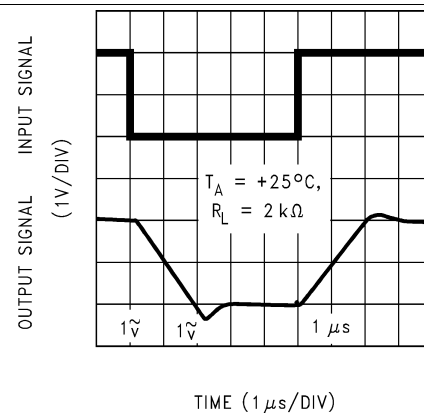

**Figure 36. Noninverting Large Signal Pulse Response**

Typical Characteristics (continued)

$V_S = 15\text{ V}$ , Single Supply,  $T_A = 25^\circ\text{C}$  unless otherwise specified

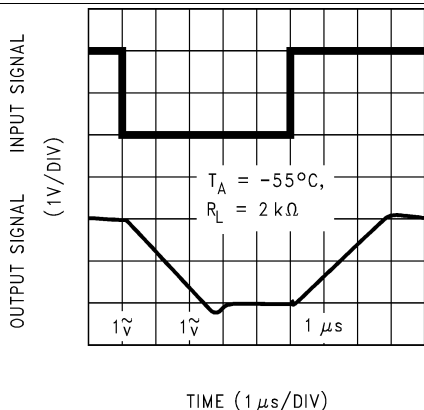

Figure 37. Noninverting Large Signal Pulse Response

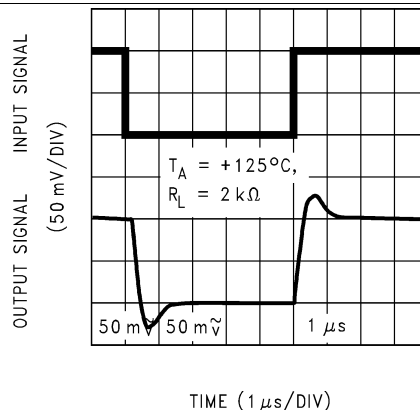

Figure 38. Noninverting Small Signal Pulse Response

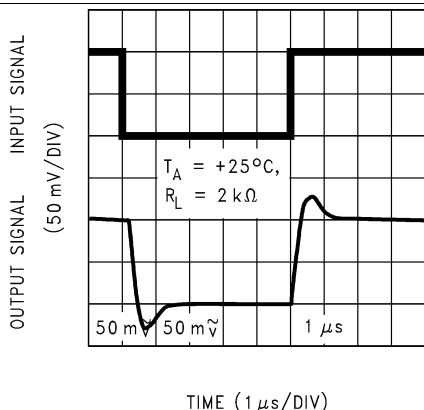

Figure 39. Noninverting Small Signal Pulse Response

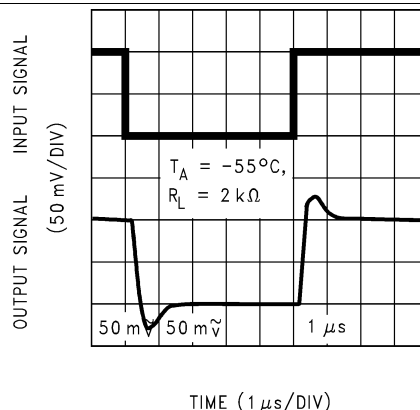

Figure 40. Noninverting Small Signal Pulse Response

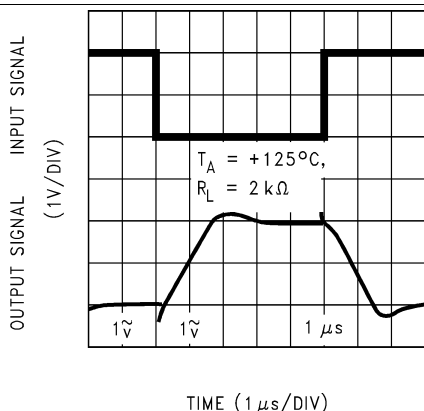

Figure 41. Inverting Large Signal Pulse Response

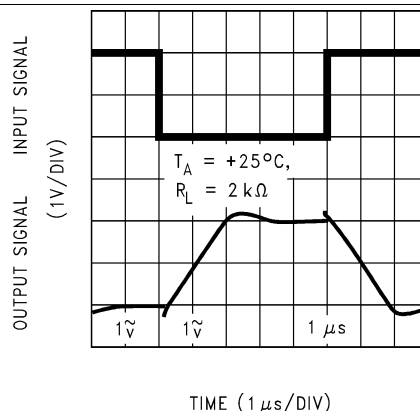

Figure 42. Inverting Large Signal Pulse Response

Typical Characteristics (continued)

$V_S = 15\text{ V}$ , Single Supply,  $T_A = 25^\circ\text{C}$  unless otherwise specified

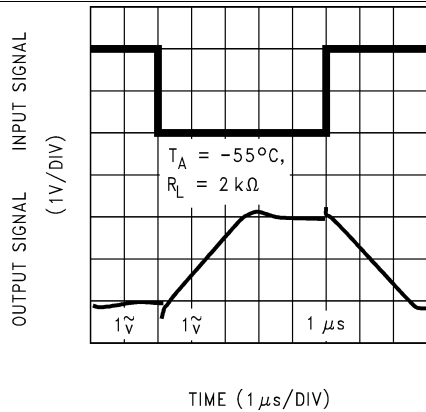

Figure 43. Inverting Large Signal Pulse Response

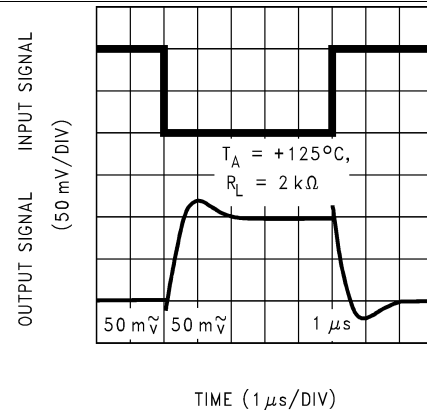

Figure 44. Inverting Small Signal Pulse Response

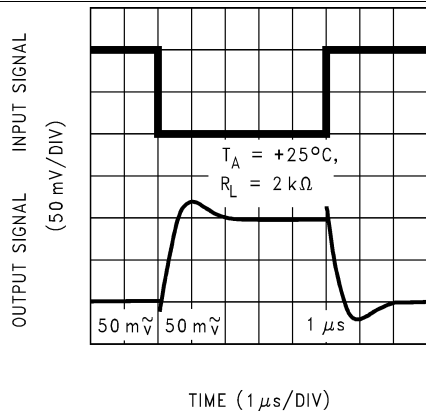

Figure 45. Inverting Small Signal Pulse Response

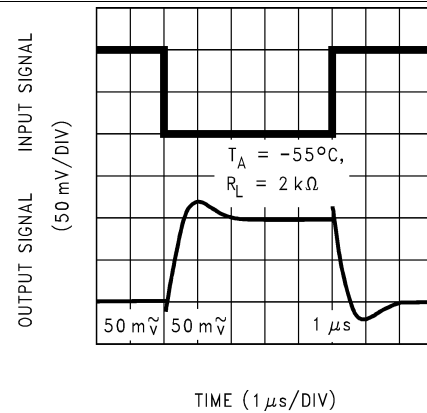

Figure 46. Inverting Small Signal Pulse Response

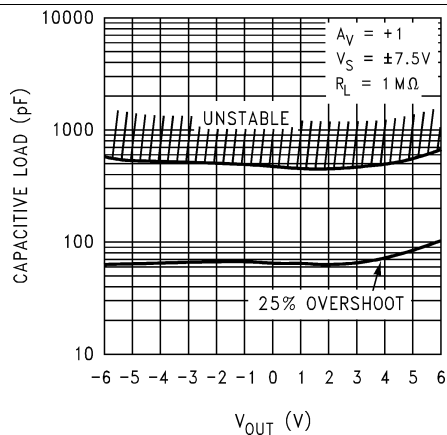

Figure 47. Stability vs. Capacitive Load

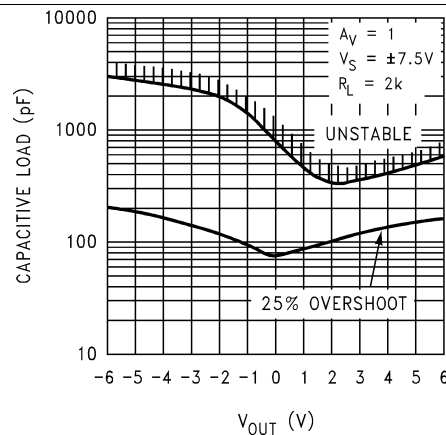

Figure 48. Stability vs. Capacitive Load

Typical Characteristics (continued)

$V_S = 15\text{ V}$ , Single Supply,  $T_A = 25^\circ\text{C}$  unless otherwise specified

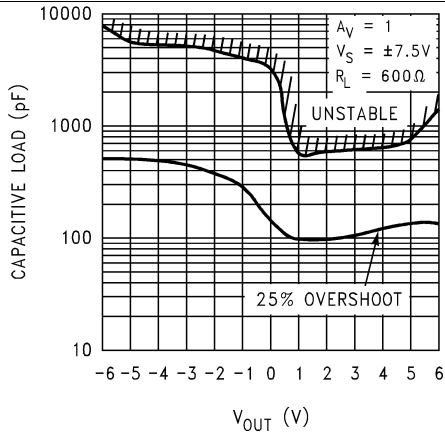

Figure 49. Stability vs. Capacitive Load

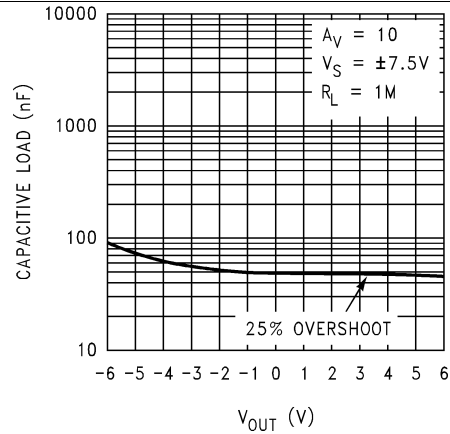

Figure 50. Stability vs. Capacitive Load

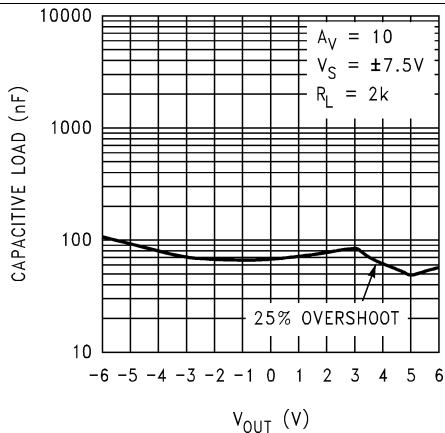

Figure 51. Stability vs. Capacitive Load

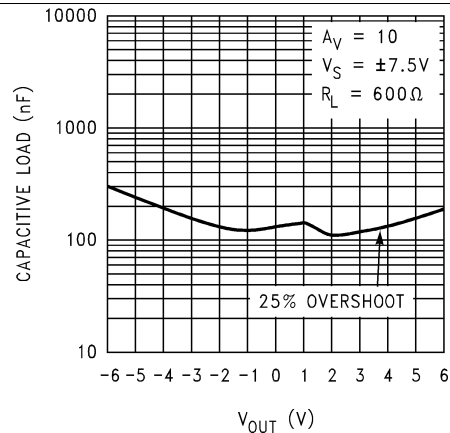

Figure 52. Stability vs. Capacitive Load

## 7 Detailed Description

### 7.1 Overview

The LMC6482 is a dual CMOS operational amplifier that supports both rail-to-rail inputs and outputs. It may be operated in both dual supply mode and single supply mode.

### 7.2 Functional Block Diagram

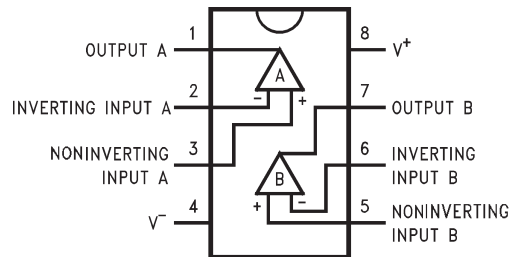

### 7.3 Feature Description

#### 7.3.1 Amplifier Topology

The LMC6482 incorporates specially designed wide-compliance range current mirrors and the body effect to extend input common-mode range to each supply rail. Complementary paralleled differential input stages, like the type used in other CMOS and bipolar rail-to-rail input amplifiers, were not used because of their inherent accuracy problems due to CMRR, crossover distortion, and open-loop gain variation.

The LMC6482s input stage design is complemented by an output stage capable of rail-to-rail output swing even when driving a large load. Rail-to-rail output swing is obtained by taking the output directly from the internal integrator instead of an output buffer stage.

#### 7.3.2 Input Common-Mode Voltage Range

Unlike Bi-FET amplifier designs, the LMC6482 does not exhibit phase inversion when an input voltage exceeds the negative supply voltage. Figure 53 shows an input voltage exceeding both supplies with no resulting phase inversion on the output.

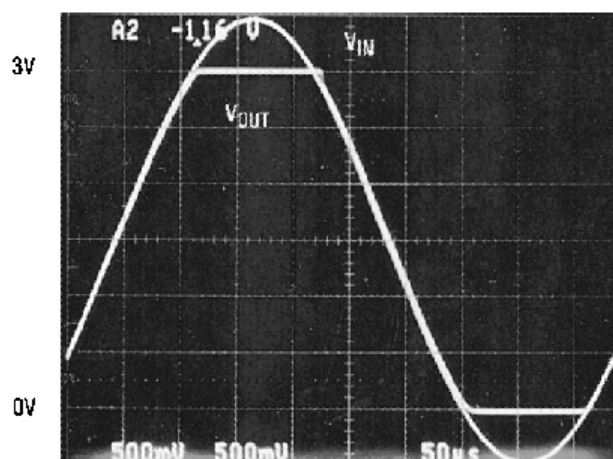

An input voltage signal exceeds the LMC6482 power supply voltages with no output phase inversion.

**Figure 53. Input Voltage**

The absolute maximum input voltage is 300 mV beyond either supply rail at room temperature. Voltages greatly exceeding this absolute maximum rating, as in Figure 54, can cause excessive current to flow in or out of the input pins possibly affecting reliability.

## Feature Description (continued)

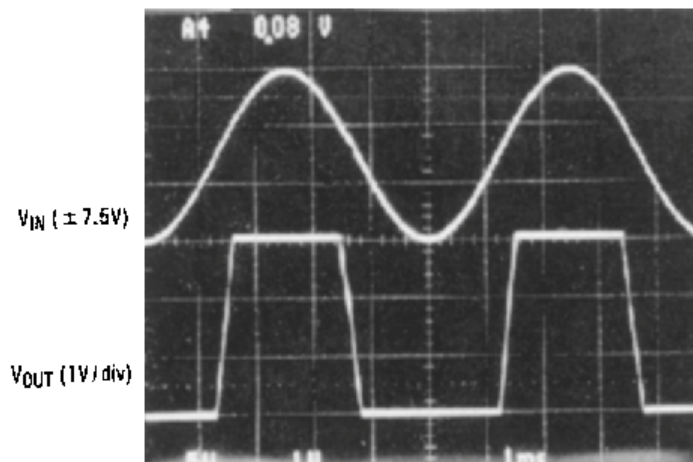

A  $\pm 7.5\text{-V}$  input signal greatly exceeds the 3-V supply in Figure 55 causing no phase inversion due to  $R_I$ .

Figure 54. Input Signal

Applications that exceed this rating must externally limit the maximum input current to  $\pm 5\text{ mA}$  with an input resistor ( $R_I$ ) as shown in Figure 55.

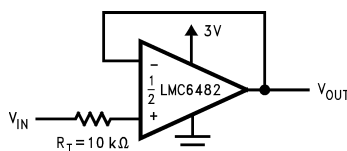

$R_I$  input current protection for voltages exceeding the supply voltages.

Figure 55.  $R_I$  Input Current Protection for Voltages Exceeding the Supply Voltages

### 7.3.3 Rail-to-Rail Output

The approximated output resistance of the LMC6482 is 180- $\Omega$  sourcing and 13- $0\Omega$  sinking at  $V_S = 3\text{ V}$  and 110- $\Omega$  sourcing and 80- $\Omega$  sinking at  $V_S = 5\text{ V}$ . Using the calculated output resistance, maximum output voltage swing can be estimated as a function of load.

## 7.4 Device Functional Modes

The LMC6482 may be used in applications where each amplifier channel is used independently, or in applications in which the channels are cascaded. See [Typical Applications](#) for more information.

## 8 Application and Implementation

### NOTE

Information in the following applications sections is not part of the TI component specification, and TI does not warrant its accuracy or completeness. TI's customers are responsible for determining suitability of components for their purposes. Customers should validate and test their design implementation to confirm system functionality.

### 8.1 Application Information

#### 8.1.1 Upgrading Applications

The LMC6484 quads and LMC6482 duals have industry-standard pin outs to retrofit existing applications. System performance can be greatly increased by the features of the LMC6482. The key benefit of designing in the LMC6482 is increased linear signal range. Most op-amps have limited input common-mode ranges. Signals that exceed this range generate a nonlinear output response that persists long after the input signal returns to the common-mode range.

Linear signal range is vital in applications such as filters where signal peaking can exceed input common-mode ranges resulting in output phase inversion or severe distortion.

#### 8.1.2 Data Acquisition Systems

Low power, single supply data acquisition system solutions are provided by buffering the ADC12038 with the LMC6482 (Figure 56). Capable of using the full supply range, the LMC6482 does not require input signals to be scaled down to meet limited common-mode voltage ranges. The LMC4282 CMRR of 82 dB maintains integral linearity of a 12-bit data acquisition system to  $\pm 0.325$  LSB. Other rail-to-rail input amplifiers with only 50 dB of CMRR will degrade the accuracy of the data acquisition system to only 8 bits.

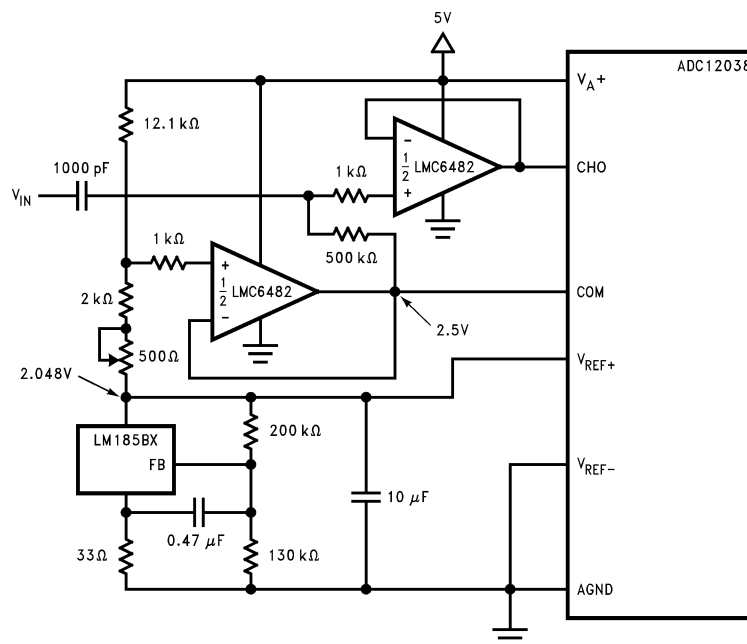

Operating from the same supply voltage, the LMC6482 buffers the ADC12038 maintaining excellent accuracy.

**Figure 56. Buffering the ADC12038 With the LMC6482**



## Application Information (continued)

Contact your local TI sales office to obtain an operational amplifier spice model library disk.

## 8.2 Typical Applications

### 8.2.1 3-V Single Supply Buffer Circuit

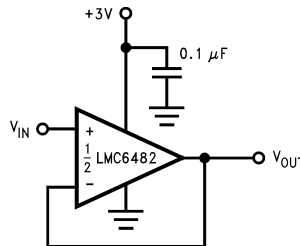

**Figure 59. 3-V Single Supply Buffer Circuit**

#### 8.2.1.1 Design Requirements

For best performance, ensure that the input voltage swing is between  $V_+$  and  $V_-$ .

Ensure that the input does not exceed the common-mode input range.

To reduce the risk of destabilizing the output, use resistive isolation on the output when driving capacitive loads (see the [Detailed Design Procedure](#) section).

When large feedback resistors are used, it may be necessary to compensate for parasitic capacitance on the input. See the [Detailed Design Procedure](#) section.

#### 8.2.1.2 Detailed Design Procedure

##### 8.2.1.2.1 Capacitive Load Compensation

Capacitive load compensation can be accomplished using resistive isolation as shown in [Figure 60](#). This simple technique is useful for isolating the capacitive inputs of multiplexers and A/D converters.

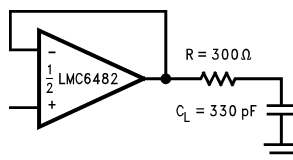

**Figure 60. Resistive Isolation of a 330-pF Capacitive Load**

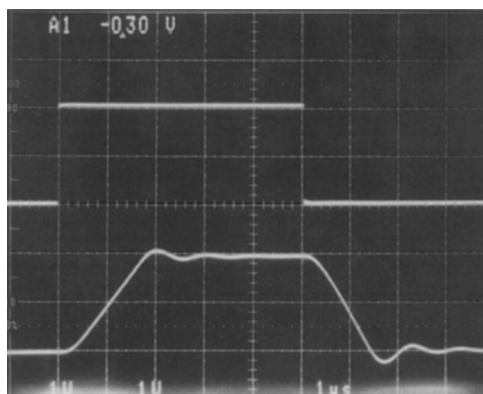

**Figure 61. Pulse Response of the LMC6482 Circuit in [Figure 60](#)**

## Typical Applications (continued)

### 8.2.1.2.1.1 Capacitive Load Tolerance

The LMC6482 can typically directly drive a 100-pF load with  $V_S = 15\text{ V}$  at unity gain without oscillating. The unity gain follower is the most sensitive configuration. Direct capacitive loading reduces the phase margin of op-amps. The combination of the output impedance of the op-amp and the capacitive load induces phase lag. This results in either an underdamped pulse response or oscillation.

Improved frequency response is achieved by indirectly driving capacitive loads, as shown in [Figure 62](#).

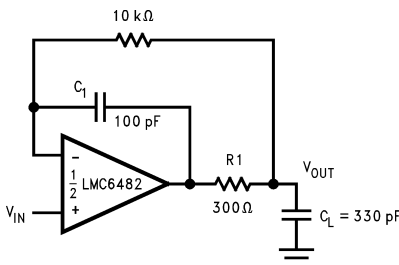

Compensated to handle a 330pF capacitive load.

**Figure 62. LMC6482 Noninverting Amplifier**

R1 and C1 serve to counteract the loss of phase margin by feeding forward the high-frequency component of the output signal back to the amplifiers inverting input, thereby preserving phase margin in the overall feedback loop. The values of R1 and C1 are experimentally determined for the desired pulse response. The resulting pulse response is shown in [Figure 63](#).

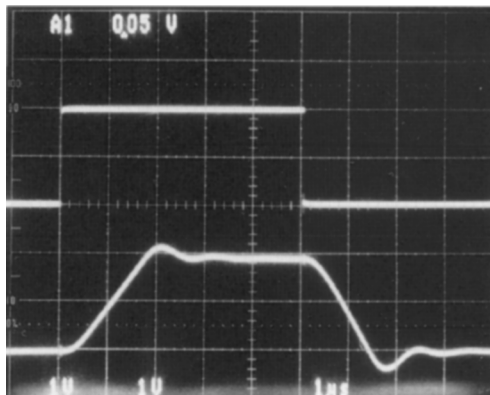

**Figure 63. Pulse Response of Lmc6482 Circuit in [Figure 62](#)**

### 8.2.1.2.1.2 Compensating For Input Capacitance

It is quite common to use large values of feedback resistance with amplifiers that have ultralow input current, like the LMC6482. Large feedback resistors can react with small values of input capacitance due to transducers, photo diodes, and circuits board parasitics to reduce phase margins.

Typical Applications (continued)

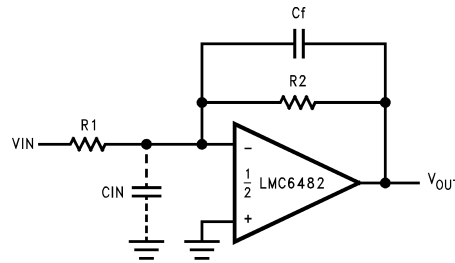

Figure 64. Canceling the Effect of Input Capacitance

The effect of input capacitance can be compensated for by adding a feedback capacitor. The feedback capacitor (as in Figure 64), Cf, is first estimated by:

$$\frac{1}{2\pi R_1 C_{IN}} \geq \frac{1}{2\pi R_2 C_f} \tag{1}$$

or

$$R_1 C_{IN} \leq R_2 C_f \tag{2}$$

which typically provides significant overcompensation.

Printed-circuit-board stray capacitance may be larger or smaller than that of a bread-board, so the actual optimum value for Cf may be different. The values of Cf should be checked on the actual circuit. (Refer to the LMC660 quad CMOS amplifier data sheet for a more detailed discussion.)

8.2.1.2.1.3 Offset Voltage Adjustment

Offset voltage adjustment circuits are illustrated in Figure 65 and Figure 66. Large value resistances and potentiometers are used to reduce power consumption while providing typically ±2.5 mV of adjustment range, referred to the input, for both configurations with VS = ±5 V.

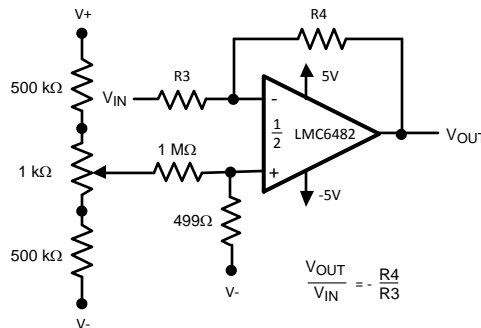

Figure 65. Inverting Configuration Offset Voltage Adjustment

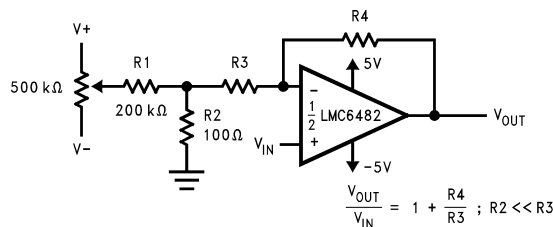
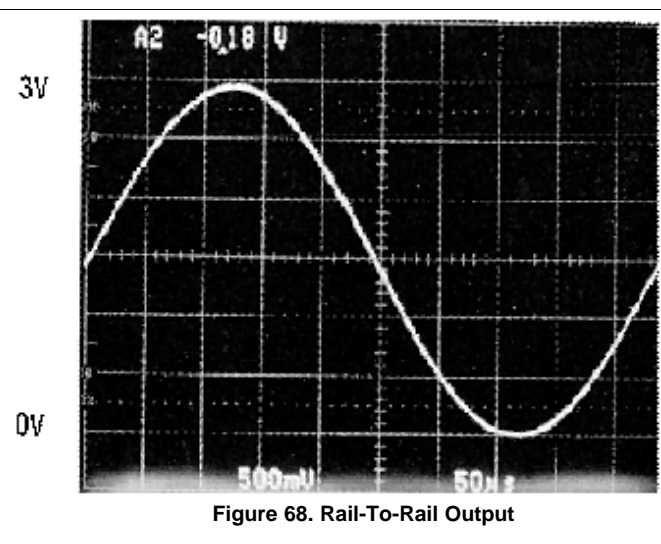
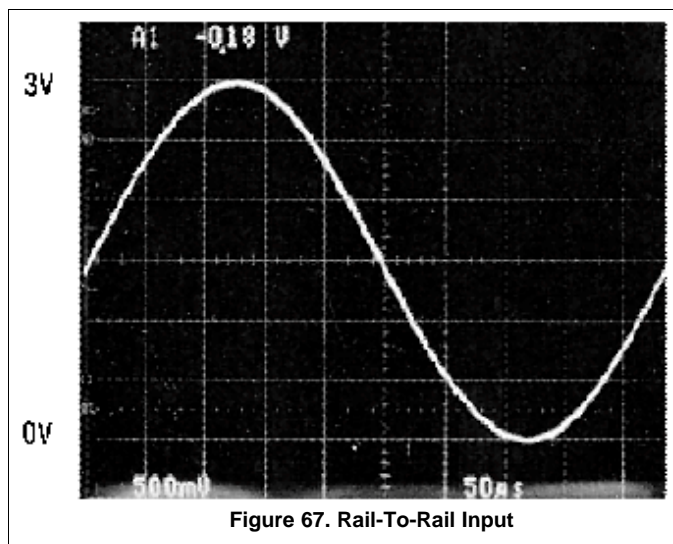

Figure 66. Noninverting Configuration Offset Voltage Adjustment

## Typical Applications (continued)

### 8.2.1.3 Application Curves



### 8.2.2 Typical Single-Supply Applications

The circuit in Figure 69 uses a single supply to half-wave rectify a sinusoid centered about ground.  $R_1$  limits current into the amplifier caused by the input voltage exceeding the supply voltage. Full-wave rectification is provided by the circuit in Figure 71.

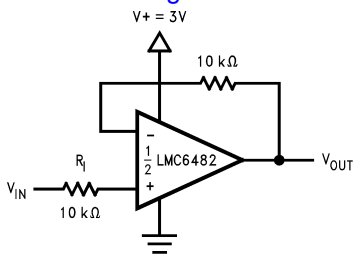
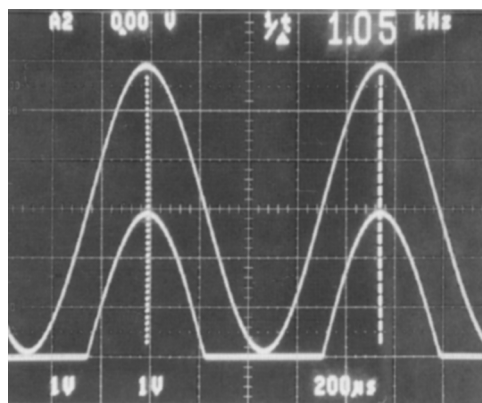
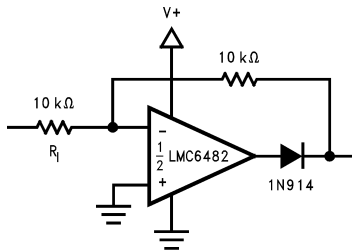

Figure 69. Half-Wave Rectifier With Input Current Protection ( $R_1$ )



**Typical Applications (continued)**

In [Figure 75](#) dielectric absorption and leakage is minimized by using a polystyrene or polyethylene hold capacitor. The droop rate is primarily determined by the value of  $C_H$  and diode leakage current. The ultralow input current of the LMC6482 has a negligible effect on droop.



**Figure 71. Full-Wave Rectifier With Input Current Protection ( $R_1$ )**

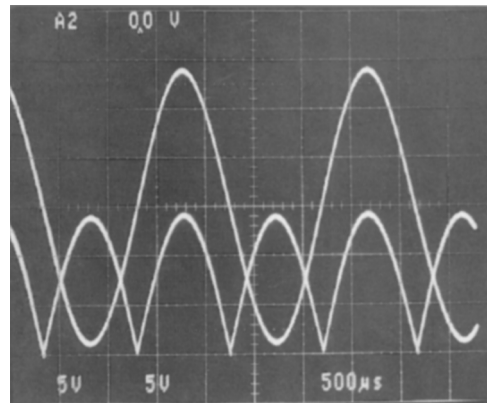

**Figure 72. Full-Wave Rectifier Waveform**

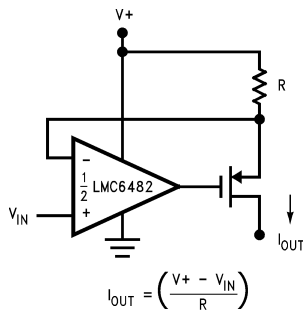

**Figure 73. Large Compliance Range Current Source**

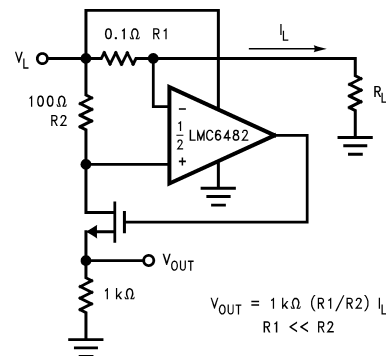

**Figure 74. Positive Supply Current Sense**

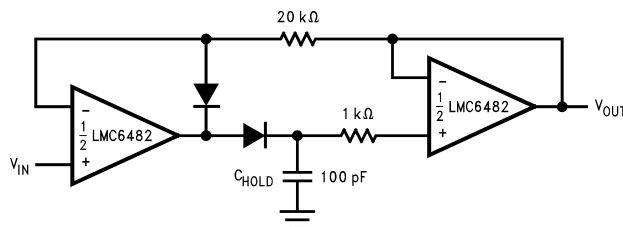

**Figure 75. Low-Voltage Peak Detector With Rail-To-Rail Peak Capture Range**

Typical Applications (continued)

The high CMRR (82 dB) of the LMC6482 allows excellent accuracy throughout the rail-to-rail dynamic capture range of the circuit.

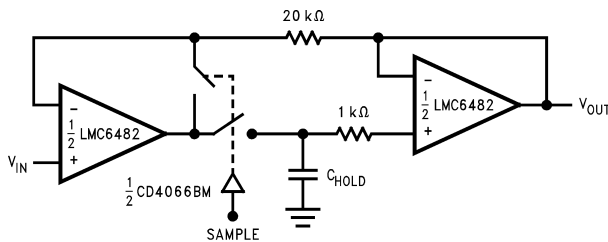
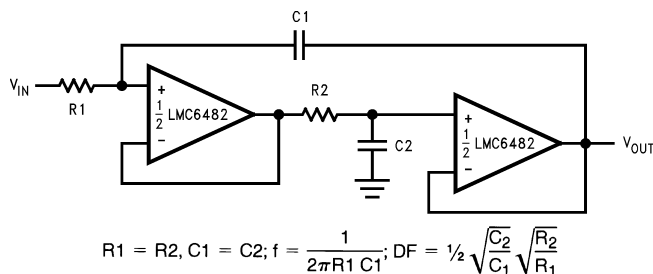

Figure 76. Rail-To-Rail Sample and Hold

The low-pass filter circuit in Figure 77 can be used as an anti-aliasing filter with the same voltage supply as the A/D converter.

Filter designs can also take advantage of the LMC6482 ultralow input current. The ultralow input current yields negligible offset error even when large value resistors are used. This in turn allows the use of smaller valued capacitors which take less board space and cost less.



$$R1 = R2, C1 = C2; f = \frac{1}{2\pi R1 C1}; DF = \frac{1}{2} \sqrt{\frac{C2}{C1}} \sqrt{\frac{R2}{R1}}$$

Figure 77. Rail-To-Rail Single Supply Low Pass Filter

## 9 Power Supply Recommendations

The LMC6482 can be operated over a supply range of 3 V to 15 V. To achieve noise immunity as appropriate to the application, it is important to use good PCB layout practices for power supply rails and planes, as well as using bypass capacitors connected between the power supply pins and ground.

## 10 Layout

### 10.1 Layout Guidelines

It is generally recognized that any circuit which must operate with less than 1000 pA of leakage current requires special layout of the PC board. When one wishes to take advantage of the ultralow input current of the LMC6482, typically less than 20 fA, it is essential to have an excellent layout. Fortunately, the techniques of obtaining low leakages are quite simple. First, the user must not ignore the surface leakage of the PCB, even through it may sometimes appear acceptably low, because under conditions of high humidity or dust or contamination, the surface leakage will be appreciable.

To minimize the effect of any surface leakage, lay out a ring of foil completely surrounding the LM6482s inputs and the terminals of capacitors, diodes, conductors, resistors, relay terminals, and so forth connected to the inputs of the op-amp, as in [Figure 78](#). To have a significant effect, guard rings should be placed on both the top and bottom of the PCB. This PC foil must then be connected to a voltage which is at the same voltage as the amplifier inputs, because no leakage current can flow between two points at the same potential. For example, a PCB trace-to-pad resistance of  $10^{12} \Omega$ , which is normally considered a very large resistance, could leak 5 pA if the trace were a 5-V bus adjacent to the pad of the input. This would cause a 250 times degradation from the actual performance of the LMC6482. However, if a guard ring is held within 5 mV of the inputs, then even a resistance of  $10^{11} \Omega$  would cause only 0.05 pA of leakage current. See [Figure 79](#) through [Figure 81](#) for typical connections of guard rings for standard op-amp configurations.

The designer should be aware that when it is inappropriate to lay out a PCB for the sake of just a few circuits, another technique is even better than a guard ring on a PCB: Do not insert the input pin of the amplifier into the PCB at all, but bend it up in the air and use only air as an insulator. Air is an excellent insulator. In this case you may have to forego some of the advantages of PCB construction, but the advantages are sometimes well worth the effort of using point-to-point up-in-the-air wiring. See [Figure 82](#).

### 10.2 Layout Example

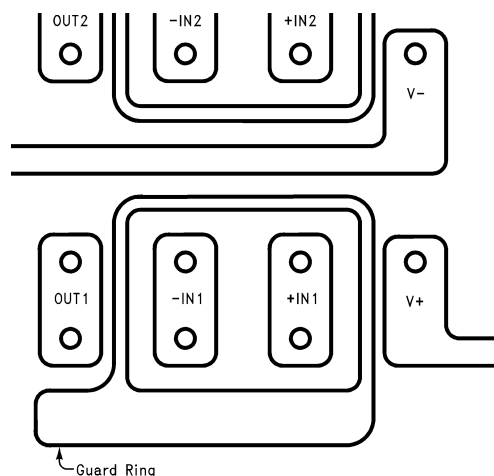

**Figure 78. Example of Guard Ring in PCB Layout Typical Connections of Guard Rings**

Layout Example (continued)

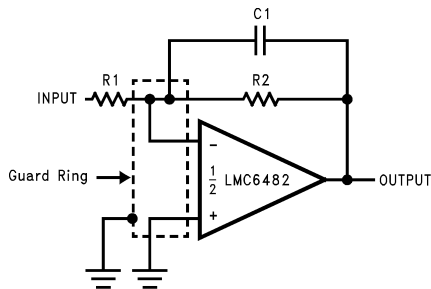

Figure 79. Inverting Amplifier Typical Connections of Guard Rings

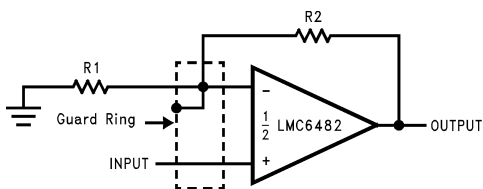

Figure 80. Noninverting Amplifier Typical Connections of Guard Rings

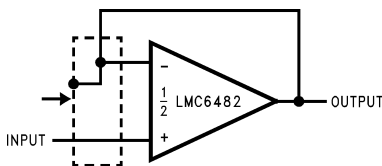
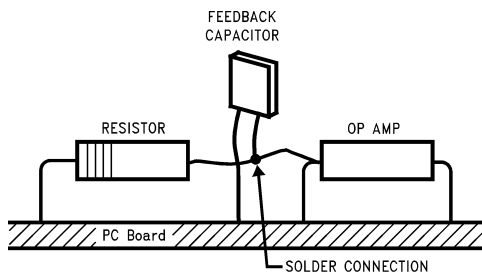

Figure 81. Follower Typical Connections of Guard Rings



(Input pins are lifted out of PCB and soldered directly to components. All other pins connected to PCB.)

Figure 82. Air Wiring

## 11 Device and Documentation Support

### 11.1 Trademarks

All trademarks are the property of their respective owners.

### 11.2 Electrostatic Discharge Caution



These devices have limited built-in ESD protection. The leads should be shorted together or the device placed in conductive foam during storage or handling to prevent electrostatic damage to the MOS gates.

### 11.3 Glossary

[SLYZ022](#) — *TI Glossary*.

This glossary lists and explains terms, acronyms, and definitions.

## 12 Mechanical, Packaging, and Orderable Information

The following pages include mechanical, packaging, and orderable information. This information is the most current data available for the designated devices. This data is subject to change without notice and revision of this document. For browser-based versions of this data sheet, refer to the left-hand navigation.

**PACKAGING INFORMATION**

| Orderable Device | Status<br>(1) | Package Type | Package Drawing | Pins | Package Qty | Eco Plan<br>(2)         | Lead/Ball Finish<br>(6) | MSL Peak Temp<br>(3) | Op Temp (°C) | Device Marking<br>(4/5) | Samples                 |
|------------------|---------------|--------------|-----------------|------|-------------|-------------------------|-------------------------|----------------------|--------------|-------------------------|-------------------------|
| LMC6482AIM       | NRND          | SOIC         | D               | 8    | 95          | TBD                     | Call TI                 | Call TI              | -40 to 85    | LMC6482AIM              |                         |
| LMC6482AIM/NOPB  | ACTIVE        | SOIC         | D               | 8    | 95          | Green (RoHS & no Sb/Br) | CU SN                   | Level-1-260C-UNLIM   | -40 to 85    | LMC6482AIM              | <a href="#">Samples</a> |
| LMC6482AIMX      | NRND          | SOIC         | D               | 8    | 2500        | TBD                     | Call TI                 | Call TI              | -40 to 85    | LMC6482AIM              |                         |
| LMC6482AIMX/NOPB | ACTIVE        | SOIC         | D               | 8    | 2500        | Green (RoHS & no Sb/Br) | CU SN                   | Level-1-260C-UNLIM   | -40 to 85    | LMC6482AIM              | <a href="#">Samples</a> |
| LMC6482AIN/NOPB  | ACTIVE        | PDIP         | P               | 8    | 40          | Green (RoHS & no Sb/Br) | CU SN                   | Level-1-NA-UNLIM     | -40 to 85    | LMC6482AIN              | <a href="#">Samples</a> |
| LMC6482IM        | NRND          | SOIC         | D               | 8    | 95          | TBD                     | Call TI                 | Call TI              | -40 to 85    | LMC6482IM               |                         |
| LMC6482IM/NOPB   | ACTIVE        | SOIC         | D               | 8    | 95          | Green (RoHS & no Sb/Br) | CU SN                   | Level-1-260C-UNLIM   | -40 to 85    | LMC6482IM               | <a href="#">Samples</a> |
| LMC6482IMM       | NRND          | VSSOP        | DGK             | 8    | 1000        | TBD                     | Call TI                 | Call TI              | -40 to 85    | A10                     |                         |
| LMC6482IMM/NOPB  | ACTIVE        | VSSOP        | DGK             | 8    | 1000        | Green (RoHS & no Sb/Br) | CU SN                   | Level-1-260C-UNLIM   | -40 to 85    | A10                     | <a href="#">Samples</a> |
| LMC6482IMMX      | NRND          | VSSOP        | DGK             | 8    | 3500        | TBD                     | Call TI                 | Call TI              | -40 to 85    | A10                     |                         |
| LMC6482IMMX/NOPB | ACTIVE        | VSSOP        | DGK             | 8    | 3500        | Green (RoHS & no Sb/Br) | CU SN                   | Level-1-260C-UNLIM   | -40 to 85    | A10                     | <a href="#">Samples</a> |
| LMC6482IMX       | NRND          | SOIC         | D               | 8    | 2500        | TBD                     | Call TI                 | Call TI              | -40 to 85    | LMC6482IMX              |                         |
| LMC6482IMX/NOPB  | ACTIVE        | SOIC         | D               | 8    | 2500        | Green (RoHS & no Sb/Br) | CU SN                   | Level-1-260C-UNLIM   | -40 to 85    | LMC6482IMX              | <a href="#">Samples</a> |
| LMC6482IN/NOPB   | ACTIVE        | PDIP         | P               | 8    | 40          | Green (RoHS & no Sb/Br) | CU SN                   | Level-1-NA-UNLIM     | -40 to 85    | LMC6482IN               | <a href="#">Samples</a> |

(1) The marketing status values are defined as follows:

**ACTIVE:** Product device recommended for new designs.

**LIFEBUY:** TI has announced that the device will be discontinued, and a lifetime-buy period is in effect.

**NRND:** Not recommended for new designs. Device is in production to support existing customers, but TI does not recommend using this part in a new design.

**PREVIEW:** Device has been announced but is not in production. Samples may or may not be available.

**OBSOLETE:** TI has discontinued the production of the device.

---

(2) **RoHS:** TI defines "RoHS" to mean semiconductor products that are compliant with the current EU RoHS requirements for all 10 RoHS substances, including the requirement that RoHS substance do not exceed 0.1% by weight in homogeneous materials. Where designed to be soldered at high temperatures, "RoHS" products are suitable for use in specified lead-free processes. TI may reference these types of products as "Pb-Free".

**RoHS Exempt:** TI defines "RoHS Exempt" to mean products that contain lead but are compliant with EU RoHS pursuant to a specific EU RoHS exemption.

**Green:** TI defines "Green" to mean the content of Chlorine (Cl) and Bromine (Br) based flame retardants meet JS709B low halogen requirements of  $\leq 1000$ ppm threshold. Antimony trioxide based flame retardants must also meet the  $\leq 1000$ ppm threshold requirement.

(3) MSL, Peak Temp. - The Moisture Sensitivity Level rating according to the JEDEC industry standard classifications, and peak solder temperature.

(4) There may be additional marking, which relates to the logo, the lot trace code information, or the environmental category on the device.

(5) Multiple Device Markings will be inside parentheses. Only one Device Marking contained in parentheses and separated by a "~" will appear on a device. If a line is indented then it is a continuation of the previous line and the two combined represent the entire Device Marking for that device.

(6) Lead/Ball Finish - Orderable Devices may have multiple material finish options. Finish options are separated by a vertical ruled line. Lead/Ball Finish values may wrap to two lines if the finish value exceeds the maximum column width.

**Important Information and Disclaimer:** The information provided on this page represents TI's knowledge and belief as of the date that it is provided. TI bases its knowledge and belief on information provided by third parties, and makes no representation or warranty as to the accuracy of such information. Efforts are underway to better integrate information from third parties. TI has taken and continues to take reasonable steps to provide representative and accurate information but may not have conducted destructive testing or chemical analysis on incoming materials and chemicals. TI and TI suppliers consider certain information to be proprietary, and thus CAS numbers and other limited information may not be available for release.

In no event shall TI's liability arising out of such information exceed the total purchase price of the TI part(s) at issue in this document sold by TI to Customer on an annual basis.

**TAPE AND REEL INFORMATION**

**QUADRANT ASSIGNMENTS FOR PIN 1 ORIENTATION IN TAPE**

\*All dimensions are nominal

| Device           | Package Type | Package Drawing | Pins | SPQ  | Reel Diameter (mm) | Reel Width W1 (mm) | A0 (mm) | B0 (mm) | K0 (mm) | P1 (mm) | W (mm) | Pin1 Quadrant |
|------------------|--------------|-----------------|------|------|--------------------|--------------------|---------|---------|---------|---------|--------|---------------|
| LMC6482AIMX      | SOIC         | D               | 8    | 2500 | 330.0              | 12.4               | 6.5     | 5.4     | 2.0     | 8.0     | 12.0   | Q1            |
| LMC6482AIMX/NOPB | SOIC         | D               | 8    | 2500 | 330.0              | 12.4               | 6.5     | 5.4     | 2.0     | 8.0     | 12.0   | Q1            |
| LMC6482IMM       | VSSOP        | DGK             | 8    | 1000 | 178.0              | 12.4               | 5.3     | 3.4     | 1.4     | 8.0     | 12.0   | Q1            |
| LMC6482IMM/NOPB  | VSSOP        | DGK             | 8    | 1000 | 178.0              | 12.4               | 5.3     | 3.4     | 1.4     | 8.0     | 12.0   | Q1            |
| LMC6482IMMX      | VSSOP        | DGK             | 8    | 3500 | 330.0              | 12.4               | 5.3     | 3.4     | 1.4     | 8.0     | 12.0   | Q1            |
| LMC6482IMMX/NOPB | VSSOP        | DGK             | 8    | 3500 | 330.0              | 12.4               | 5.3     | 3.4     | 1.4     | 8.0     | 12.0   | Q1            |
| LMC6482IMX       | SOIC         | D               | 8    | 2500 | 330.0              | 12.4               | 6.5     | 5.4     | 2.0     | 8.0     | 12.0   | Q1            |
| LMC6482IMX/NOPB  | SOIC         | D               | 8    | 2500 | 330.0              | 12.4               | 6.5     | 5.4     | 2.0     | 8.0     | 12.0   | Q1            |

**TAPE AND REEL BOX DIMENSIONS**

\*All dimensions are nominal

| Device           | Package Type | Package Drawing | Pins | SPQ  | Length (mm) | Width (mm) | Height (mm) |
|------------------|--------------|-----------------|------|------|-------------|------------|-------------|
| LMC6482AIMX      | SOIC         | D               | 8    | 2500 | 367.0       | 367.0      | 35.0        |
| LMC6482AIMX/NOPB | SOIC         | D               | 8    | 2500 | 367.0       | 367.0      | 35.0        |
| LMC6482IMM       | VSSOP        | DGK             | 8    | 1000 | 210.0       | 185.0      | 35.0        |
| LMC6482IMM/NOPB  | VSSOP        | DGK             | 8    | 1000 | 210.0       | 185.0      | 35.0        |
| LMC6482IMMX      | VSSOP        | DGK             | 8    | 3500 | 367.0       | 367.0      | 35.0        |
| LMC6482IMMX/NOPB | VSSOP        | DGK             | 8    | 3500 | 367.0       | 367.0      | 35.0        |
| LMC6482IMX       | SOIC         | D               | 8    | 2500 | 367.0       | 367.0      | 35.0        |
| LMC6482IMX/NOPB  | SOIC         | D               | 8    | 2500 | 367.0       | 367.0      | 35.0        |



D0008A

# PACKAGE OUTLINE

SOIC - 1.75 mm max height

SMALL OUTLINE INTEGRATED CIRCUIT



4214825/C 02/2019

NOTES:

- Linear dimensions are in inches [millimeters]. Dimensions in parenthesis are for reference only. Controlling dimensions are in inches. Dimensioning and tolerancing per ASME Y14.5M.
- This drawing is subject to change without notice.
- This dimension does not include mold flash, protrusions, or gate burrs. Mold flash, protrusions, or gate burrs shall not exceed .006 [0.15] per side.
- This dimension does not include interlead flash.
- Reference JEDEC registration MS-012, variation AA.

# EXAMPLE BOARD LAYOUT

D0008A

SOIC - 1.75 mm max height

SMALL OUTLINE INTEGRATED CIRCUIT



LAND PATTERN EXAMPLE  
EXPOSED METAL SHOWN  
SCALE:8X



SOLDER MASK DETAILS

4214825/C 02/2019

NOTES: (continued)

- 6. Publication IPC-7351 may have alternate designs.
- 7. Solder mask tolerances between and around signal pads can vary based on board fabrication site.

# EXAMPLE STENCIL DESIGN

D0008A

SOIC - 1.75 mm max height

SMALL OUTLINE INTEGRATED CIRCUIT



SOLDER PASTE EXAMPLE  
BASED ON .005 INCH [0.125 MM] THICK STENCIL  
SCALE:8X

4214825/C 02/2019

NOTES: (continued)

8. Laser cutting apertures with trapezoidal walls and rounded corners may offer better paste release. IPC-7525 may have alternate design recommendations.
9. Board assembly site may have different recommendations for stencil design.

P (R-PDIP-T8)

PLASTIC DUAL-IN-LINE PACKAGE



- NOTES:
- A. All linear dimensions are in inches (millimeters).
  - B. This drawing is subject to change without notice.
  - C. Falls within JEDEC MS-001 variation BA.

DGK (S-PDSO-G8)

PLASTIC SMALL-OUTLINE PACKAGE

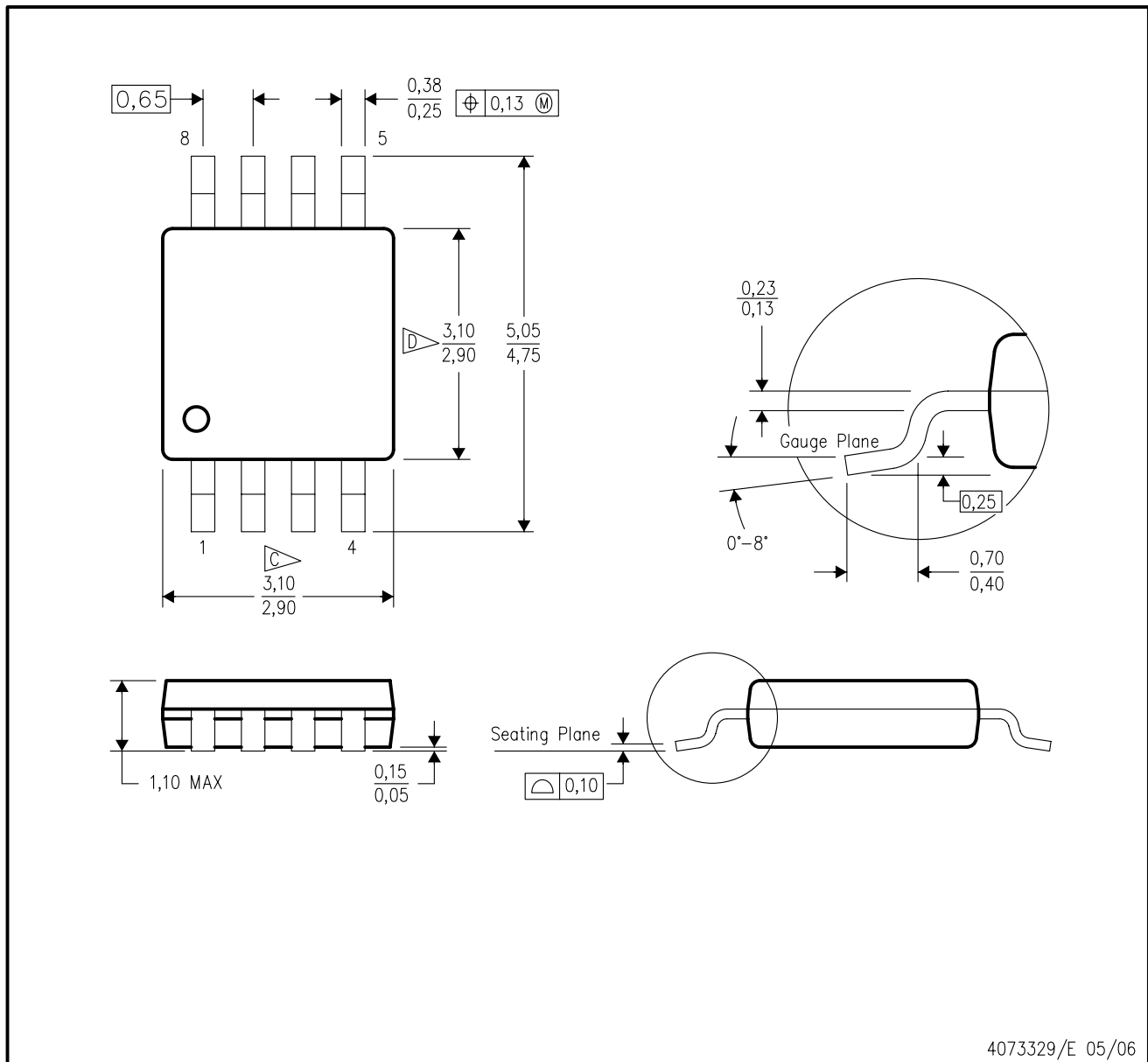

4073329/E 05/06

- NOTES:
- A. All linear dimensions are in millimeters.
  - B. This drawing is subject to change without notice.
  - C. Body length does not include mold flash, protrusions, or gate burrs. Mold flash, protrusions, or gate burrs shall not exceed 0.15 per end.
  - D. Body width does not include interlead flash. Interlead flash shall not exceed 0.50 per side.
  - E. Falls within JEDEC MO-187 variation AA, except interlead flash.



- NOTES:
- All linear dimensions are in millimeters.
  - This drawing is subject to change without notice.
  - Publication IPC-7351 is recommended for alternate designs.
  - Laser cutting apertures with trapezoidal walls and also rounding corners will offer better paste release. Customers should contact their board assembly site for stencil design recommendations. Refer to IPC-7525 for other stencil recommendations.
  - Customers should contact their board fabrication site for solder mask tolerances between and around signal pads.

## IMPORTANT NOTICE AND DISCLAIMER

TI PROVIDES TECHNICAL AND RELIABILITY DATA (INCLUDING DATASHEETS), DESIGN RESOURCES (INCLUDING REFERENCE DESIGNS), APPLICATION OR OTHER DESIGN ADVICE, WEB TOOLS, SAFETY INFORMATION, AND OTHER RESOURCES "AS IS" AND WITH ALL FAULTS, AND DISCLAIMS ALL WARRANTIES, EXPRESS AND IMPLIED, INCLUDING WITHOUT LIMITATION ANY IMPLIED WARRANTIES OF MERCHANTABILITY, FITNESS FOR A PARTICULAR PURPOSE OR NON-INFRINGEMENT OF THIRD PARTY INTELLECTUAL PROPERTY RIGHTS.

These resources are intended for skilled developers designing with TI products. You are solely responsible for (1) selecting the appropriate TI products for your application, (2) designing, validating and testing your application, and (3) ensuring your application meets applicable standards, and any other safety, security, or other requirements. These resources are subject to change without notice. TI grants you permission to use these resources only for development of an application that uses the TI products described in the resource. Other reproduction and display of these resources is prohibited. No license is granted to any other TI intellectual property right or to any third party intellectual property right. TI disclaims responsibility for, and you will fully indemnify TI and its representatives against, any claims, damages, costs, losses, and liabilities arising out of your use of these resources.

TI's products are provided subject to TI's Terms of Sale ([www.ti.com/legal/termsofsale.html](http://www.ti.com/legal/termsofsale.html)) or other applicable terms available either on [ti.com](http://ti.com) or provided in conjunction with such TI products. TI's provision of these resources does not expand or otherwise alter TI's applicable warranties or warranty disclaimers for TI products.

Mailing Address: Texas Instruments, Post Office Box 655303, Dallas, Texas 75265  
Copyright © 2019, Texas Instruments Incorporated

## Looking for pricing, stock, or lifecycle information?

Click below to explore more details on WIN SOURCE:

 [View LMC6482IM](#) on WIN SOURCE

 [Texas Instruments](#) Information

## Optimize Your Supply Chain with WIN SOURCE Solutions

-  Global Sourcing Solution
-  Obsolete Management
-  Cost Control Management
-  Shortage Management
-  Alternative Solution
-  Excess Inventory Management