



**THE DATASHEET OF
LM5100MX/NOPB**



LM5100 /LM5101 High Voltage High Side and Low Side Gate Driver

Check for Samples: [LM5100](#), [LM5101](#)

FEATURES

- Drives Both a High Side and Low Side N-Channel MOSFET
- Independent High and Low Driver Logic Inputs (TTL for LM5101 or CMOS for LM5100)
- Bootstrap Supply Voltage Range up to 118V DC
- Fast Propagation Times (25 ns Typical)
- Drives 1000 pF Load with 15 ns Rise and Fall Times
- Excellent Propagation Delay Matching (3 ns Typical)
- Supply Rail Under-voltage Lockouts
- Low Power Consumption
- Pin Compatible with HIP2100/HIP2101

TYPICAL APPLICATIONS

- Current Fed Push-pull Converters
- Half and Full Bridge Power Converters
- Synchronous Buck Converters
- Two Switch Forward Power Converters
- Forward with Active Clamp Converters

PACKAGE

- SOIC-8
- WSON-10 (4 mm x 4 mm)

DESCRIPTION

The LM5100/LM5101 High Voltage Gate Drivers are designed to drive both the high side and the low side N-Channel MOSFETs in a synchronous buck or a half bridge configuration. The floating high-side driver is capable of operating with supply voltages up to 100V. The outputs are independently controlled with CMOS input thresholds (LM5100) or TTL input thresholds (LM5101). An integrated high voltage diode is provided to charge the high side gate drive bootstrap capacitor. A robust level shifter operates at high speed while consuming low power and providing clean level transitions from the control logic to the high side gate driver. Under-voltage lockout is provided on both the low side and the high side power rails. This device is available in the standard SOIC-8 pin and the WSON-10 pin packages.



Please be aware that an important notice concerning availability, standard warranty, and use in critical applications of Texas Instruments semiconductor products and disclaimers thereto appears at the end of this data sheet.

All trademarks are the property of their respective owners.

Simplified Block Diagram

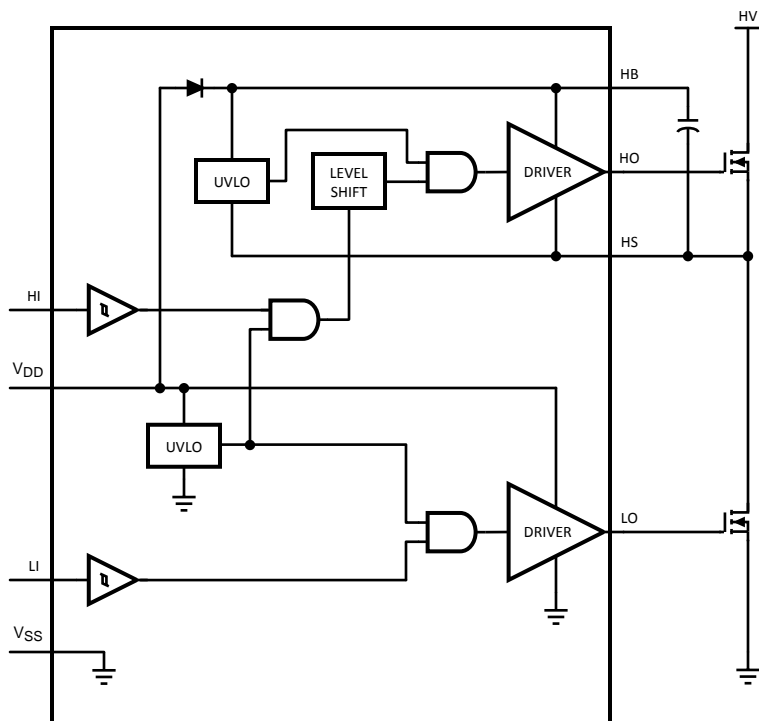

Connection Diagrams

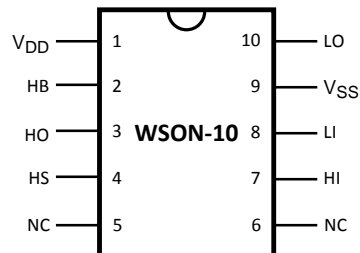
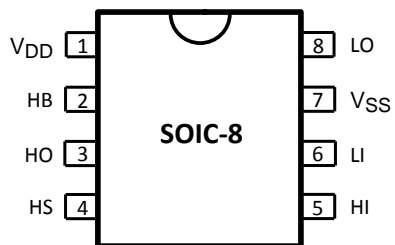

PIN DESCRIPTION⁽¹⁾

Pin #		Name	Description	Application Information
SO-8	WSON-10			
1	1	V _{DD}	Positive gate drive supply	Locally decouple to V _{SS} using low ESR/ESL capacitor located as close to IC as possible.
2	2	HB	High side gate driver bootstrap rail	Connect the positive terminal of the bootstrap capacitor to HB and the negative terminal to HS. The Bootstrap capacitor should be placed as close to IC as possible.
3	3	HO	High side gate driver output	Connect to gate of high side MOSFET with a short low inductance path.
4	4	HS	High side MOSFET source connection	Connect to bootstrap capacitor negative terminal and the source of the high side MOSFET.
5	7	HI	High side driver control input	The LM5100 inputs have CMOS type thresholds. The LM5101 inputs have TTL type thresholds. Unused inputs should be tied to ground and not left open.
6	8	LI	Low side driver control input	The LM5100 inputs have CMOS type thresholds. The LM5101 inputs have TTL type thresholds. Unused inputs should be tied to ground and not left open.
7	9	V _{SS}	Ground return	All signals are referenced to this ground.
8	10	LO	Low side gate driver output	Connect to the gate of the low side MOSFET with a short low inductance path.

- (1) **Note:** For WSON-10 package, it is recommended that the exposed pad on the bottom of the LM5100 / LM5101 be soldered to ground plane on the PC board, and the ground plane should extend out from beneath the IC to help dissipate the heat. Pins 5 and 6 have no connection.



These devices have limited built-in ESD protection. The leads should be shorted together or the device placed in conductive foam during storage or handling to prevent electrostatic damage to the MOS gates.

Absolute Maximum Ratings⁽¹⁾⁽²⁾

V _{DD} to V _{SS}	-0.3V to +18V
V _{HB} to V _{HS}	-0.3V to +18V
LI or HI Inputs	-0.3V to V _{DD} +0.3V
LO Output	-0.3V to V _{DD} +0.3V
HO Output	V _{HS} -0.3V to V _{HB} +0.3V
V _{HS} to V _{SS}	-1V to +100V
V _{HB} to V _{SS}	118V
Junction Temperature	+150°C
Storage Temperature Range	-55°C to +150°C
ESD Rating HBM ⁽³⁾	2 kV

- (1) Absolute Maximum Ratings indicate limits beyond which damage to the component may occur. Operating Ratings are conditions under which operation of the device is ensured. Operating Ratings do not imply ensured performance limits. For ensured performance limits and associated test conditions, see the Electrical Characteristics tables.
- (2) If Military/Aerospace specified devices are required, please contact the Texas Instruments Sales Office/ Distributors for availability and specifications.
- (3) The human body model is a 100 pF capacitor discharged through a 1.5kΩ resistor into each pin. 2 kV for all pins except Pin 2, Pin 3 and Pin 4 which are rated at 500V.

Recommended Operating Conditions

V _{DD}	+9V to +14V
HS	-1V to 100V
HB	V _{HS} +8V to V _{HS} +14V
HS Slew Rate	< 50 V/ns
Junction Temperature	-40°C to +125°C

Electrical Characteristics

Specifications in standard typeface are for T_J = +25°C, and those in **boldface type** apply over the full **operating junction temperature range**. Unless otherwise specified, V_{DD} = V_{HB} = 12V, V_{SS} = V_{HS} = 0V, No Load on LO or HO .

Symbol	Parameter	Conditions	Min ⁽¹⁾	Typ	Max ⁽¹⁾	Units
SUPPLY CURRENTS						
I _{DD}	V _{DD} Quiescent Current	LI = HI = 0V (LM5100)		0.1	0.2	mA
		LI = HI = 0V (LM5101)		0.25	0.4	
I _{DDO}	V _{DD} Operating Current	f = 500 kHz		1.5	3	mA
I _{HB}	Total HB Quiescent Current	LI = HI = 0V		0.06	0.2	mA
I _{HBO}	Total HB Operating Current	f = 500 kHz		1.3	3	mA
I _{HBS}	HB to V _{SS} Current, Quiescent	V _{HS} = V _{HB} = 100V		0.05	10	μA
I _{HBSO}	HB to V _{SS} Current, Operating	f = 500 kHz		0.08		mA
INPUT PINS						
V _{IL}	Low Level Input Voltage Threshold (LM5100)		3	5.0		V
V _{IL}	Low Level Input Voltage Threshold (LM5101)		0.8	1.8		V
V _{IH}	High Level Input Voltage Threshold (LM5100)			5.5	8	V
V _{IH}	High Level Input Voltage Threshold (LM5101)			1.8	2.2	V
V _{IHYS}	Input Voltage Hysteresis (LM5100)			0.5		V
R _I	Input Pulldown Resistance		100	200	500	kΩ
UNDER VOLTAGE PROTECTION						
V _{DDR}	V _{DD} Rising Threshold		6.0	6.9	7.4	V

- (1) Min and Max limits are 100% production tested at 25°C. Limits over the operating temperature range are guaranteed through correlation using Statistical Quality Control (SQC) methods. Limits are used to calculate TI's Average Outgoing Quality Level (AOQL).

Electrical Characteristics (continued)

Specifications in standard typeface are for $T_J = +25^\circ\text{C}$, and those in **boldface type** apply over the full **operating junction temperature range**. Unless otherwise specified, $V_{DD} = V_{HB} = 12\text{V}$, $V_{SS} = V_{HS} = 0\text{V}$, No Load on LO or HO.

Symbol	Parameter	Conditions	Min ⁽¹⁾	Typ	Max ⁽¹⁾	Units
V_{DDH}	V_{DD} Threshold Hysteresis			0.5		V
V_{HBR}	HB Rising Threshold		5.7	6.6	7.1	V
V_{HBH}	HB Threshold Hysteresis			0.4		V
BOOT STRAP DIODE						
V_{DL}	Low-Current Forward Voltage	$I_{VDD-HB} = 100\ \mu\text{A}$		0.6	0.9	V
V_{DH}	High-Current Forward Voltage	$I_{VDD-HB} = 100\ \text{mA}$		0.85	1.1	V
R_D	Dynamic Resistance	$I_{VDD-HB} = 100\ \text{mA}$		0.8	1.5	Ω
LO GATE DRIVER						
V_{OLL}	Low-Level Output Voltage	$I_{LO} = 100\ \text{mA}$		0.23	0.4	V
V_{OHL}	High-Level Output Voltage	$I_{LO} = -100\ \text{mA}$, $V_{OHL} = V_{DD} - V_{LO}$		0.35	0.55	V
I_{OHL}	Peak Pullup Current	$V_{LO} = 0\text{V}$		1.6		A
I_{OLL}	Peak Pulldown Current	$V_{LO} = 12\text{V}$		1.8		A
HO GATE DRIVER						
V_{OLH}	Low-Level Output Voltage	$I_{HO} = 100\ \text{mA}$		0.23	0.4	V
V_{OHH}	High-Level Output Voltage	$I_{HO} = -100\ \text{mA}$, $V_{OHH} = V_{HB} - V_{HO}$		0.35	0.55	V
I_{OHH}	Peak Pullup Current	$V_{HO} = 0\text{V}$		1.6		A
I_{OLH}	Peak Pulldown Current	$V_{HO} = 12\text{V}$		1.8		A
THERMAL RESISTANCE						
θ_{JA} ⁽²⁾	Junction to Ambient	SOIC-8		170		$^\circ\text{C/W}$
		WSO-10 ⁽³⁾		40		

(2) The θ_{JA} is not a given constant for the package and depends on the printed circuit board design and the operating environment.

(3) 4 layer board with Cu finished thickness 1.5/1/1/1.5 oz. Maximum die size used. 5x body length of Cu trace on PCB top. 50 x 50mm ground and power planes embedded in PCB. See Application Note AN-1187 (SNOA401).

Switching Characteristics

Specifications in standard typeface are for $T_J = +25^\circ\text{C}$, and those in **boldface type** apply over the full **operating junction temperature range**. Unless otherwise specified, $V_{DD} = V_{HB} = 12\text{V}$, $V_{SS} = V_{HS} = 0\text{V}$, No Load on LO or HO.

Symbol	Parameter	Conditions	Min ⁽¹⁾	Typ	Max ⁽¹⁾	Units
LM5100						
t_{LPHL}	Lower Turn-Off Propagation Delay (LI Falling to LO Falling)			24	45	ns
t_{HPHL}	Upper Turn-Off Propagation Delay (HI Falling to HO Falling)			24	45	ns
t_{LPLH}	Lower Turn-On Propagation Delay (LI Rising to LO Rising)			24	45	ns
t_{HPLH}	Upper Turn-On Propagation Delay (HI Rising to HO Rising)			24	45	ns
t_{MON}	Delay Matching: Lower Turn-On and Upper Turn-Off			2	10	ns
t_{MOFF}	Delay Matching: Lower Turn-Off and Upper Turn-On			2	10	ns
t_{RC}, t_{FC}	Either Output Rise/Fall Time	$C_L = 1000\ \text{pF}$		15		ns
t_R, t_F	Either Output Rise/Fall Time (3V to 9V)	$C_L = 0.1\ \mu\text{F}$		0.6		μs
t_{PW}	Minimum Input Pulse Width that Changes the Output			50		ns

(1) Min and Max limits are 100% production tested at 25°C . Limits over the operating temperature range are guaranteed through correlation using Statistical Quality Control (SQC) methods. Limits are used to calculate TI's Average Outgoing Quality Level (AOQL).

Switching Characteristics (continued)

Specifications in standard typeface are for $T_J = +25^\circ\text{C}$, and those in **boldface type** apply over the full **operating junction temperature range**. Unless otherwise specified, $V_{DD} = V_{HB} = 12\text{V}$, $V_{SS} = V_{HS} = 0\text{V}$, No Load on LO or HO.

Symbol	Parameter	Conditions	Min ⁽¹⁾	Typ	Max ⁽¹⁾	Units
t_{BS}	Bootstrap Diode Turn-Off Time	$I_F = 20\text{ mA}$, $I_R = 200\text{ mA}$		50		ns
LM5101						
t_{LPHL}	Lower Turn-Off Propagation Delay (LI Falling to LO Falling)			25	56	ns
t_{HPHL}	Upper Turn-Off Propagation Delay (HI Falling to HO Falling)			25	56	ns
t_{LPLH}	Lower Turn-On Propagation Delay (LI Rising to LO Rising)			25	56	ns
t_{HPLH}	Upper Turn-On Propagation Delay (HI Rising to HO Rising)			25	56	ns
t_{MON}	Delay Matching: Lower Turn-On and Upper Turn-Off			2	10	ns
t_{MOFF}	Delay Matching: Lower Turn-Off and Upper Turn-On			2	10	ns
t_{RC}, t_{FC}	Either Output Rise/Fall Time	$C_L = 1000\text{ pF}$		15		ns
t_R, t_F	Either Output Rise/Fall Time (3V to 9V)	$C_L = 0.1\text{ }\mu\text{F}$		0.6		μs
t_{PW}	Minimum Input Pulse Width that Changes the Output			50		ns
t_{BS}	Bootstrap Diode Turn-Off Time	$I_F = 20\text{ mA}$, $I_R = 200\text{ mA}$		50		ns

Typical Performance Characteristics

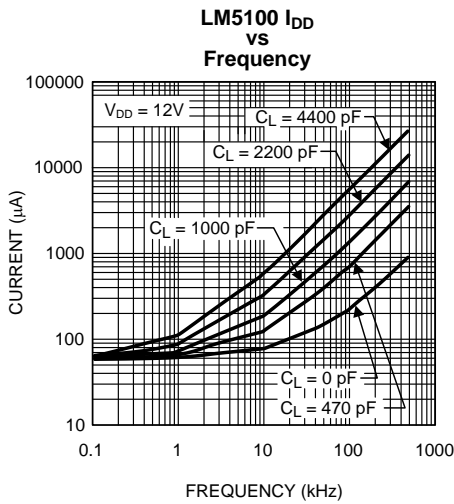

Figure 1.

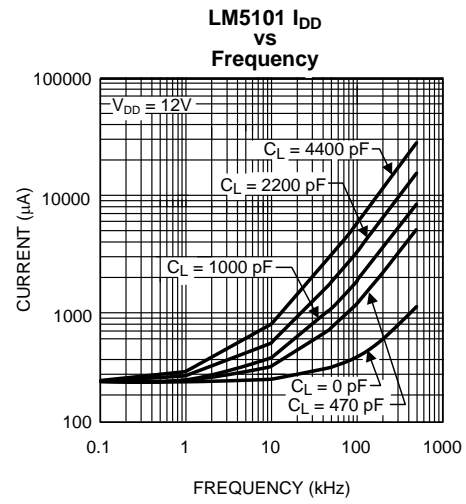

Figure 2.

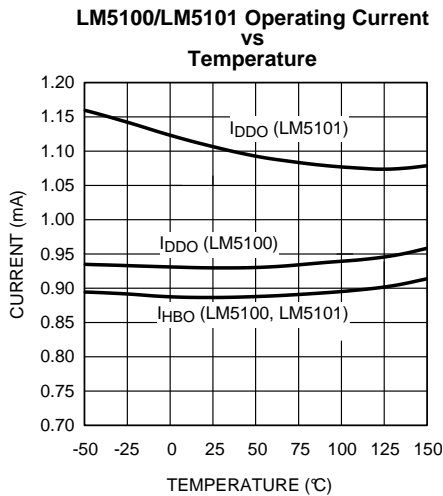

Figure 3.

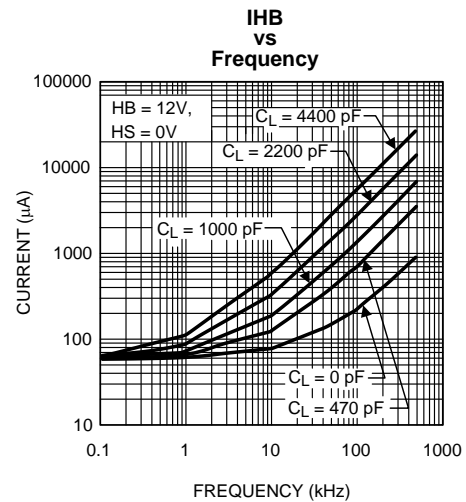

Figure 4.

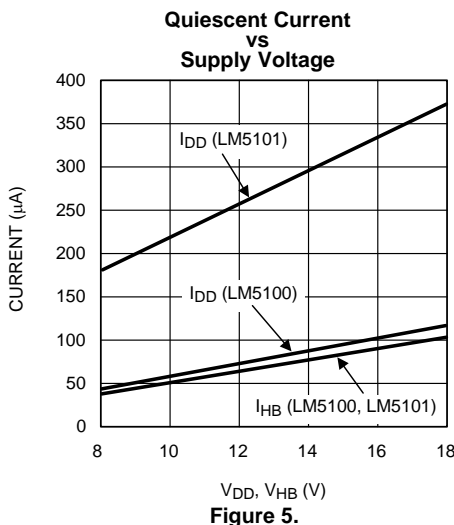

Figure 5.

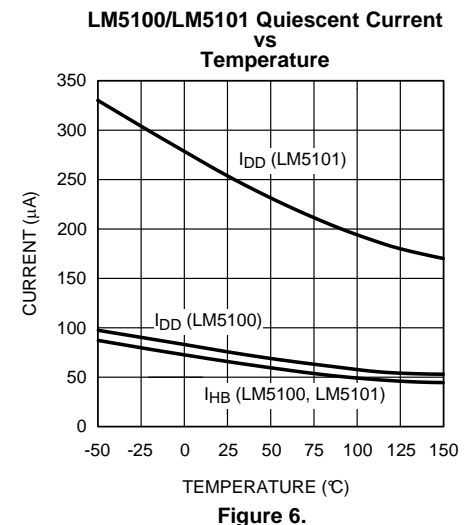

Figure 6.

Typical Performance Characteristics (continued)
Undervoltage Rising Thresholds vs Temperature

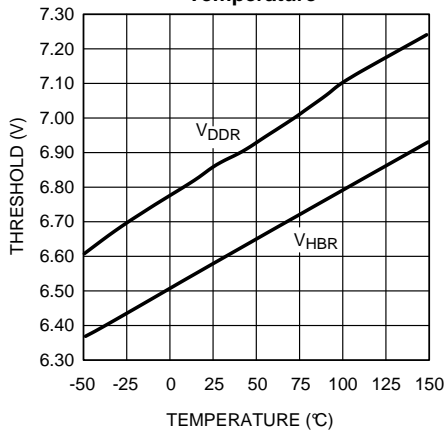

Figure 7.

LM5100 Undervoltage Threshold Hysteresis vs Temperature

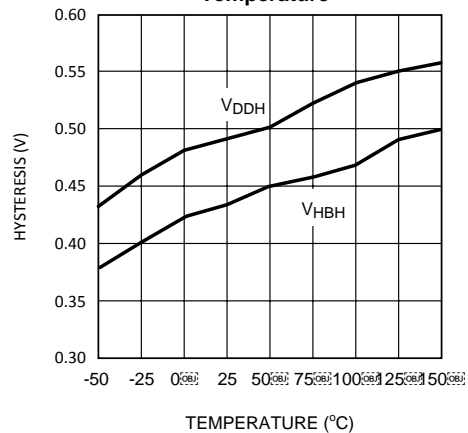

Figure 8.

Bootstrap Diode Forward Voltage

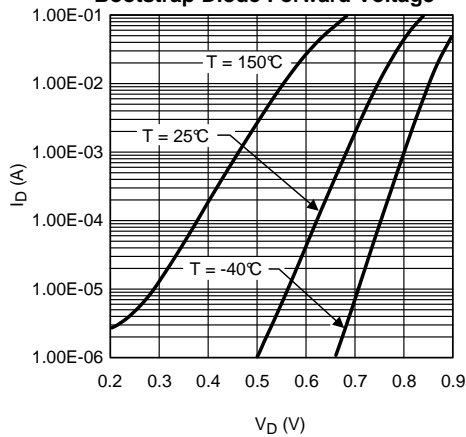

Figure 9.

HO and LO Peak Output Current vs Output Voltage

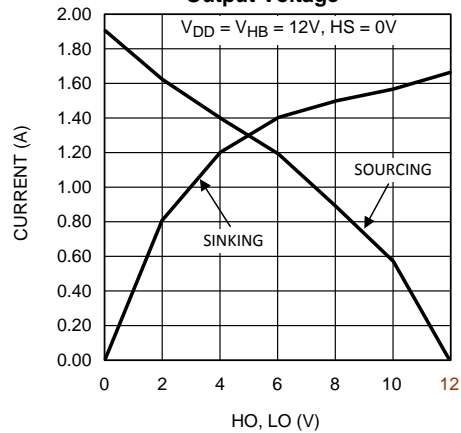

Figure 10.

LO and HO Gate Drive—High Level Output Voltage vs Temperature

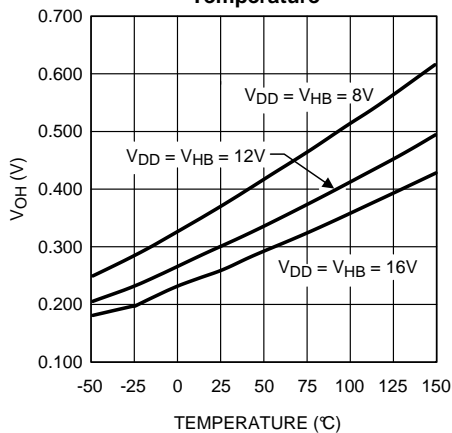

Figure 11.

LO and HO Gate Drive—Low Level Output Voltage vs Temperature

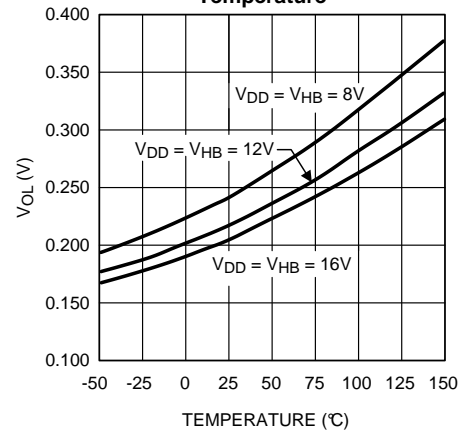

Figure 12.

Typical Performance Characteristics (continued)

LM5100 Propagation Delay vs Temperature

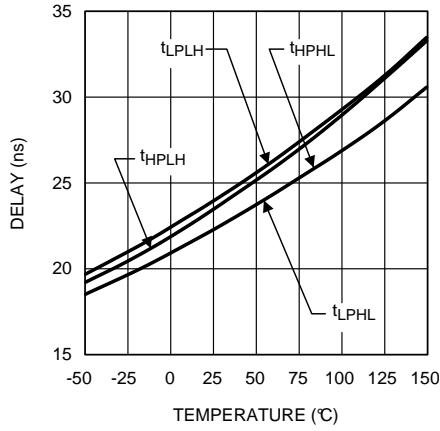

Figure 13.

LM5101 Propagation Delay vs Temperature

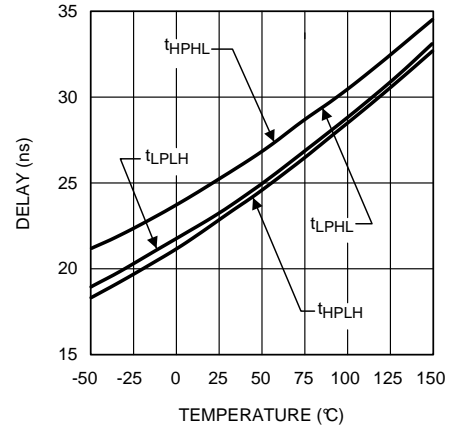

Figure 14.

Timing Diagram

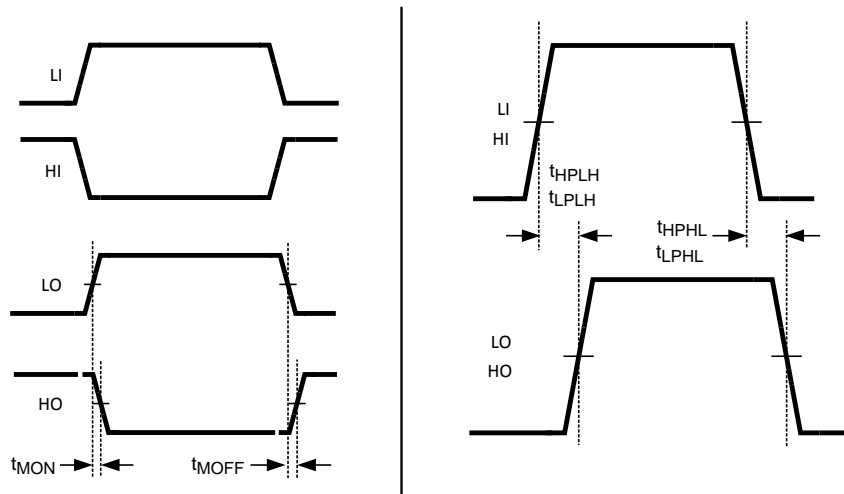

Figure 15.

LAYOUT CONSIDERATIONS

The optimum performance of high and low side gate drivers cannot be achieved without taking due considerations during circuit board layout. Following points are emphasized.

1. A low ESR / ESL capacitor must be connected close to the IC, and between V_{DD} and V_{SS} pins and between HB and HS pins to support high peak currents being drawn from V_{DD} during turn-on of the external MOSFET.
2. To prevent large voltage transients at the drain of the top MOSFET, a low ESR electrolytic capacitor must be connected between MOSFET drain and ground (V_{SS}).
3. In order to avoid large negative transients on the switch node (HS) pin, the parasitic inductances in the source of top MOSFET and in the drain of the bottom MOSFET (synchronous rectifier) must be minimized.
4. Grounding Considerations:
 - a) The first priority in designing grounding connections is to confine the high peak currents from charging and discharging the MOSFET gate in a minimal physical area. This will decrease the loop inductance and minimize noise issues on the gate terminal of the MOSFET. The MOSFETs should be placed as close as possible to the gate driver.
 - b) The second high current path includes the bootstrap capacitor, the bootstrap diode, the local ground referenced bypass capacitor and low side MOSFET body diode. The bootstrap capacitor is recharged on the cycle-by-cycle basis through the bootstrap diode from the ground referenced V_{DD} bypass capacitor. The recharging occurs in a short time interval and involves high peak current. Minimizing this loop length and area on the circuit board is important to ensure reliable operation.

Power Dissipation Considerations

The total IC power dissipation is the sum of the gate driver losses and the bootstrap diode losses. The gate driver losses are related to the switching frequency (f), output load capacitance on LO and HO (C_L), and supply voltage (V_{DD}) and can be roughly calculated as:

$$P_{DGATES} = 2 \cdot f \cdot C_L \cdot V_{DD}^2$$

There are some additional losses in the gate drivers due to the internal CMOS stages used to buffer the LO and HO outputs. The following plot shows the measured gate driver power dissipation versus frequency and load capacitance. At higher frequencies and load capacitance values, the power dissipation is dominated by the power losses driving the output loads and agrees well with the above equation. This plot can be used to approximate the power losses due to the gate drivers.

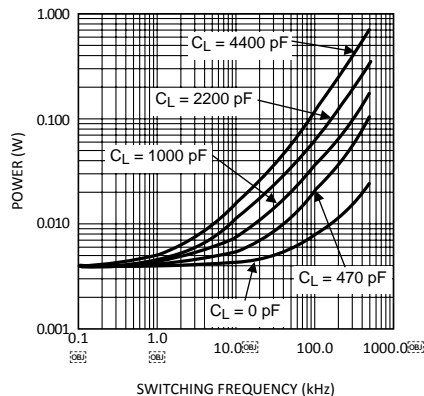

**Figure 16. Gate Driver Power Dissipation (LO + HO)
 $V_{CC} = 12V$, Neglecting Diode Losses**

The bootstrap diode power loss is the sum of the forward bias power loss that occurs while charging the bootstrap capacitor and the reverse bias power loss that occurs during reverse recovery. Since each of these events happens once per cycle, the diode power loss is proportional to frequency. Larger capacitive loads require more current to recharge the bootstrap capacitor resulting in more losses. Higher input voltages (V_{IN}) to the half bridge result in higher reverse recovery losses. The following plot was generated based on calculations and lab measurements of the diode recovery time and current under several operating conditions. This can be useful for approximating the diode power dissipation.

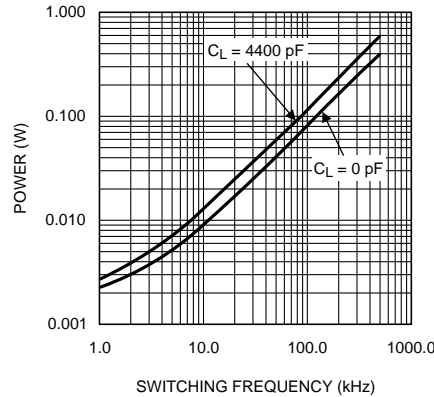

Figure 17. Diode Power Dissipation $V_{IN} = 80V$

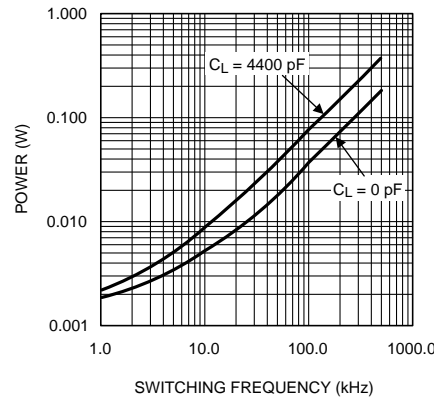

Figure 18. Diode Power Dissipation $V_{IN} = 40V$

The total IC power dissipation can be estimated from the previous plots by summing the gate drive losses with the bootstrap diode losses for the intended application. Because the diode losses can be significant, an external diode placed in parallel (refer to Figure 19) with the internal bootstrap diode can be helpful in removing power from the IC. For this to be effective, the external diode must be placed close to the IC to minimize series inductance and have a significantly lower forward voltage drop than the internal diode.

PACKAGING INFORMATION

Orderable Device	Status (1)	Package Type	Package Drawing	Pins	Package Qty	Eco Plan (2)	Lead/Ball Finish (6)	MSL Peak Temp (3)	Op Temp (°C)	Device Marking (4/5)	Samples
LM5100MX/NOPB	OBSOLETE	SOIC	D	8		TBD	Call TI	Call TI		5100 M	
LM5101M/NOPB	NRND	SOIC	D	8	95	Green (RoHS & no Sb/Br)	CU SN	Level-1-260C-UNLIM		5101 M	
LM5101MX/NOPB	NRND	SOIC	D	8	2500	Green (RoHS & no Sb/Br)	CU SN	Level-1-260C-UNLIM		5101 M	

(1) The marketing status values are defined as follows:

ACTIVE: Product device recommended for new designs.

LIFEBUY: TI has announced that the device will be discontinued, and a lifetime-buy period is in effect.

NRND: Not recommended for new designs. Device is in production to support existing customers, but TI does not recommend using this part in a new design.

PREVIEW: Device has been announced but is not in production. Samples may or may not be available.

OBSOLETE: TI has discontinued the production of the device.

(2) Eco Plan - The planned eco-friendly classification: Pb-Free (RoHS), Pb-Free (RoHS Exempt), or Green (RoHS & no Sb/Br) - please check <http://www.ti.com/productcontent> for the latest availability information and additional product content details.

TBD: The Pb-Free/Green conversion plan has not been defined.

Pb-Free (RoHS): TI's terms "Lead-Free" or "Pb-Free" mean semiconductor products that are compatible with the current RoHS requirements for all 6 substances, including the requirement that lead not exceed 0.1% by weight in homogeneous materials. Where designed to be soldered at high temperatures, TI Pb-Free products are suitable for use in specified lead-free processes.

Pb-Free (RoHS Exempt): This component has a RoHS exemption for either 1) lead-based flip-chip solder bumps used between the die and package, or 2) lead-based die adhesive used between the die and leadframe. The component is otherwise considered Pb-Free (RoHS compatible) as defined above.

Green (RoHS & no Sb/Br): TI defines "Green" to mean Pb-Free (RoHS compatible), and free of Bromine (Br) and Antimony (Sb) based flame retardants (Br or Sb do not exceed 0.1% by weight in homogeneous material)

(3) MSL, Peak Temp. - The Moisture Sensitivity Level rating according to the JEDEC industry standard classifications, and peak solder temperature.

(4) There may be additional marking, which relates to the logo, the lot trace code information, or the environmental category on the device.

(5) Multiple Device Markings will be inside parentheses. Only one Device Marking contained in parentheses and separated by a "~" will appear on a device. If a line is indented then it is a continuation of the previous line and the two combined represent the entire Device Marking for that device.

(6) Lead/Ball Finish - Orderable Devices may have multiple material finish options. Finish options are separated by a vertical ruled line. Lead/Ball Finish values may wrap to two lines if the finish value exceeds the maximum column width.

Important Information and Disclaimer: The information provided on this page represents TI's knowledge and belief as of the date that it is provided. TI bases its knowledge and belief on information provided by third parties, and makes no representation or warranty as to the accuracy of such information. Efforts are underway to better integrate information from third parties. TI has taken and

continues to take reasonable steps to provide representative and accurate information but may not have conducted destructive testing or chemical analysis on incoming materials and chemicals. TI and TI suppliers consider certain information to be proprietary, and thus CAS numbers and other limited information may not be available for release.

In no event shall TI's liability arising out of such information exceed the total purchase price of the TI part(s) at issue in this document sold by TI to Customer on an annual basis.

TAPE AND REEL INFORMATION



QUADRANT ASSIGNMENTS FOR PIN 1 ORIENTATION IN TAPE



*All dimensions are nominal

Device	Package Type	Package Drawing	Pins	SPQ	Reel Diameter (mm)	Reel Width W1 (mm)	A0 (mm)	B0 (mm)	K0 (mm)	P1 (mm)	W (mm)	Pin1 Quadrant
LM5101MX/NOPB	SOIC	D	8	2500	330.0	12.4	6.5	5.4	2.0	8.0	12.0	Q1

TAPE AND REEL BOX DIMENSIONS

*All dimensions are nominal

Device	Package Type	Package Drawing	Pins	SPQ	Length (mm)	Width (mm)	Height (mm)
LM5101MX/NOPB	SOIC	D	8	2500	367.0	367.0	35.0

IMPORTANT NOTICE

Texas Instruments Incorporated and its subsidiaries (TI) reserve the right to make corrections, enhancements, improvements and other changes to its semiconductor products and services per JESD46, latest issue, and to discontinue any product or service per JESD48, latest issue. Buyers should obtain the latest relevant information before placing orders and should verify that such information is current and complete. All semiconductor products (also referred to herein as "components") are sold subject to TI's terms and conditions of sale supplied at the time of order acknowledgment.

TI warrants performance of its components to the specifications applicable at the time of sale, in accordance with the warranty in TI's terms and conditions of sale of semiconductor products. Testing and other quality control techniques are used to the extent TI deems necessary to support this warranty. Except where mandated by applicable law, testing of all parameters of each component is not necessarily performed.

TI assumes no liability for applications assistance or the design of Buyers' products. Buyers are responsible for their products and applications using TI components. To minimize the risks associated with Buyers' products and applications, Buyers should provide adequate design and operating safeguards.

TI does not warrant or represent that any license, either express or implied, is granted under any patent right, copyright, mask work right, or other intellectual property right relating to any combination, machine, or process in which TI components or services are used. Information published by TI regarding third-party products or services does not constitute a license to use such products or services or a warranty or endorsement thereof. Use of such information may require a license from a third party under the patents or other intellectual property of the third party, or a license from TI under the patents or other intellectual property of TI.

Reproduction of significant portions of TI information in TI data books or data sheets is permissible only if reproduction is without alteration and is accompanied by all associated warranties, conditions, limitations, and notices. TI is not responsible or liable for such altered documentation. Information of third parties may be subject to additional restrictions.

Resale of TI components or services with statements different from or beyond the parameters stated by TI for that component or service voids all express and any implied warranties for the associated TI component or service and is an unfair and deceptive business practice. TI is not responsible or liable for any such statements.

Buyer acknowledges and agrees that it is solely responsible for compliance with all legal, regulatory and safety-related requirements concerning its products, and any use of TI components in its applications, notwithstanding any applications-related information or support that may be provided by TI. Buyer represents and agrees that it has all the necessary expertise to create and implement safeguards which anticipate dangerous consequences of failures, monitor failures and their consequences, lessen the likelihood of failures that might cause harm and take appropriate remedial actions. Buyer will fully indemnify TI and its representatives against any damages arising out of the use of any TI components in safety-critical applications.

In some cases, TI components may be promoted specifically to facilitate safety-related applications. With such components, TI's goal is to help enable customers to design and create their own end-product solutions that meet applicable functional safety standards and requirements. Nonetheless, such components are subject to these terms.

No TI components are authorized for use in FDA Class III (or similar life-critical medical equipment) unless authorized officers of the parties have executed a special agreement specifically governing such use.

Only those TI components which TI has specifically designated as military grade or "enhanced plastic" are designed and intended for use in military/aerospace applications or environments. Buyer acknowledges and agrees that any military or aerospace use of TI components which have **not** been so designated is solely at the Buyer's risk, and that Buyer is solely responsible for compliance with all legal and regulatory requirements in connection with such use.

TI has specifically designated certain components as meeting ISO/TS16949 requirements, mainly for automotive use. In any case of use of non-designated products, TI will not be responsible for any failure to meet ISO/TS16949.

Products

Audio	www.ti.com/audio
Amplifiers	amplifier.ti.com
Data Converters	dataconverter.ti.com
DLP® Products	www.dlp.com
DSP	dsp.ti.com
Clocks and Timers	www.ti.com/clocks
Interface	interface.ti.com
Logic	logic.ti.com
Power Mgmt	power.ti.com
Microcontrollers	microcontroller.ti.com
RFID	www.ti-rfid.com
OMAP Applications Processors	www.ti.com/omap
Wireless Connectivity	www.ti.com/wirelessconnectivity

Applications

Automotive and Transportation	www.ti.com/automotive
Communications and Telecom	www.ti.com/communications
Computers and Peripherals	www.ti.com/computers
Consumer Electronics	www.ti.com/consumer-apps
Energy and Lighting	www.ti.com/energy
Industrial	www.ti.com/industrial
Medical	www.ti.com/medical
Security	www.ti.com/security
Space, Avionics and Defense	www.ti.com/space-avionics-defense
Video and Imaging	www.ti.com/video

TI E2E Community

e2e.ti.com

Looking for pricing, stock, or lifecycle information?

Click below to explore more details on WIN SOURCE:

 [View LM5100MX/NOPB on WIN SOURCE](#)

 [Texas Instruments](#) Information

Optimize Your Supply Chain with WIN SOURCE Solutions

-  Global Sourcing Solution
-  Obsolete Management
-  Cost Control Management
-  Shortage Management
-  Alternative Solution
-  Excess Inventory Management