



THE DATASHEET OF LM4912MMX



LM4912 Boomer® Audio Power Amplifier Series

Stereo 40mW Low Noise Headphone Amplifier

General Description

The LM4912 is an stereo audio power amplifier capable of delivering 40mW per channel of continuous average power into a 16Ω load or 25mW per channel into a 32Ω load at 1% THD from a 3V power supply.

Boomer audio power amplifiers were designed specifically to provide high quality output power with a minimal amount of external components. Since the LM4912 does not require bootstrap capacitors or snubber networks, it is optimally suited for low-power portable systems.

The LM4912 features a low-power consumption shutdown mode and a power mute mode that allows for faster turn on time with less than 1mV voltage change at outputs on release. Additionally, the LM4912 features an internal thermal shutdown protection mechanism.

The LM4912 is unity gain stable and may be configured with external gain-setting resistors.

Key Specifications

- PSRR at 217 Hz and 1kHz 65dB (typ)
- Output Power at 1kHz with $V_{DD} = 2.4V$, 1% THD +N into a 16Ω load 25mW (typ)
- Output Power at 1kHz with $V_{DD} = 3V$, 1% THD +N into a 16Ω load 40mW (typ)
- Shutdown Current 1.0μA (max)
- Output Voltage change on release from Shutdown $V_{DD} = 2.4V$, $R_L = 16Ω$ 1mV (max)
- Output Noise, 20Hz to 20kHz, A-weighted 10μV (typ)

Features

- External gain-setting capability
- Available in space-saving MSOP package
- Ultra low current shutdown mode
- Mute mode allows fast turn-on (10ms) with less than 1mV change on outputs
- 2.0V - 5.5V operation
- Ultra low noise
- Operation at low supply voltages

Applications

- Portable CD players
- PDAs
- Portable electronics devices

Typical Application

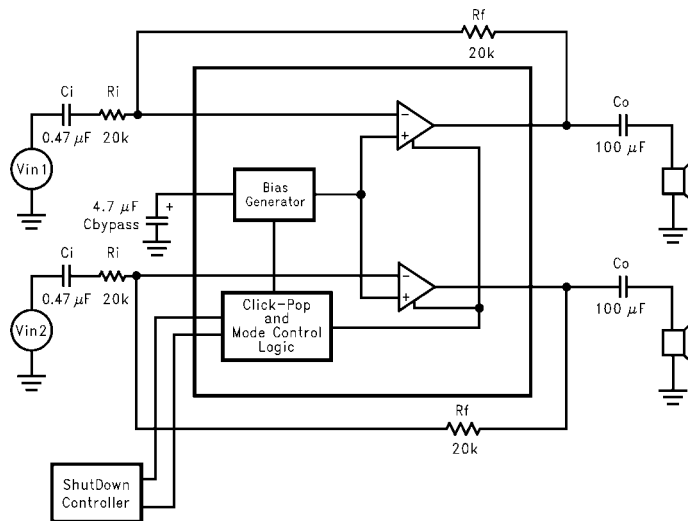
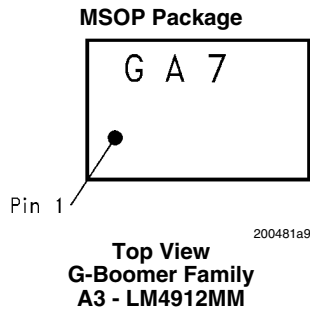
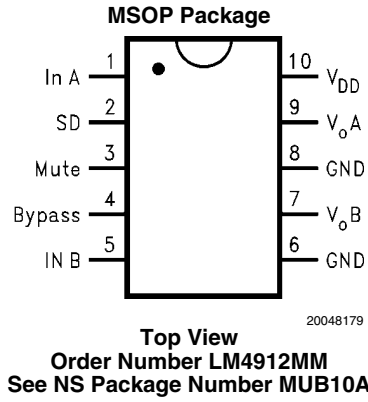

FIGURE 1. Typical Capacitive Coupled Output Configuration Circuit

Connection Diagrams



Absolute Maximum Ratings (Note 2)

If Military/Aerospace specified devices are required, please contact the National Semiconductor Sales Office/Distributors for availability and specifications.

Supply Voltage	6.0V
Storage Temperature	-65°C to +150°C
Input Voltage	-0.3V to $V_{DD} + 0.3V$
Power Dissipation (Note 3)	Internally Limited
ESD Susceptibility (Note 4)	2000V
ESD Susceptibility (Note 5)	250V

Junction Temperature	150°C
Thermal Resistance	
θ_{JC} (MSOP)	56°C/W
θ_{JA} (MSOP)	190°C/W

Operating Ratings

Temperature Range	
$T_{MIN} \leq T_A \leq T_{MAX}$	-40°C \leq T_A \leq 85°C
Supply Voltage (V_{DD})	2.0V \leq V_{DD} \leq 5.5V

Electrical Characteristics $V_{DD} = 5.0V$ (Notes 1, 2)

The following specifications apply for $V_{DD} = 5.0V$, $R_L = 16\Omega$, $C_O = 100\mu F$, and $C_B = 4.7\mu F$ unless otherwise specified. Limits apply to $T_A = 25^\circ C$.

Symbol	Parameter	Conditions	LM4912		Units (Limits)
			Typ (Note 6)	Limit (Note 7)	
I_{DD}	Quiescent Power Supply Current	$V_{IN} = 0V, I_O = 0A$	2	5	mA (max)
I_{SD}	Shutdown Current	$V_{SHUTDOWN} = GND$	0.1	2.0	μA (max)
I_M	Mute Current	$V_{MUTE} = V_{DD}$	2	5	mA (max)
V_{SDIH}	Shutdown Voltage Input High		1.8		V
V_{SDIL}	Shutdown Voltage Input Low		0.4		V
V_{MIH}	Mute Voltage Input High		1.8		V
V_{MIL}	Mute Voltage Input Low		0.4		V
P_O	Output Power	THD = 1%; f = 1kHz			mW
		R = 16 Ω	145		
		R = 32 Ω	80		
V_{NO}	Output Noise Voltage	BW = 20 Hz to 20kHz, A-weighted	10		μV
PSRR	Power Supply Rejection Ratio	$V_{RIPPLE} = 200mV$ sine p-p	65		dB
A_M	Mute Attenuation	f = 1kHz	85		dB

Electrical Characteristics $V_{DD} = 3.0V$ (Notes 1, 2)

The following specifications apply for $V_{DD} = 3.0V$, $R_L = 16\Omega$, $C_O = 100\mu F$, and $C_B = 4.7\mu F$ unless otherwise specified. Limits apply to $T_A = 25^\circ C$.

Symbol	Parameter	Conditions	LM4912		Units (Limits)
			Typ (Note 6)	Limit (Note 7)	
I_{DD}	Quiescent Power Supply Current	$V_{IN} = 0V, I_O = 0A$	1.5	3	mA (max)
I_{SD}	Shutdown Current	$V_{SHUTDOWN} = GND$	0.1	2.0	μA (max)
I_M	Mute Current	$V_{MUTE} = V_{DD}$	1.5	3	mA (max)
P_O	Output Power	THD = 1%; f = 1kHz			mW
		R = 16 Ω	40		
		R = 32 Ω	25		
V_{NO}	Output Noise Voltage	BW = 20 Hz to 20kHz, A-weighted	10		μV
PSRR	Power Supply Rejection Ratio	$V_{RIPPLE} = 200mV$ sine p-p	65		dB
A_M	Mute Attenuation	f = 1kHz	80		dB

Electrical Characteristics $V_{DD} = 2.4V$ (Notes 1, 2)

The following specifications apply for $V_{DD} = 2.4V$, $R_L = 16\Omega$, $C_O = 100\mu F$, and $C_B = 4.7\mu F$ unless otherwise specified. Limits apply to $T_A = 25^\circ C$.

Symbol	Parameter	Conditions	LM4912		Units (Limits)
			Typ (Note 6)	Limit (Note 7)	
I_{DD}	Quiescent Power Supply Current	$V_{IN} = 0V$, $I_O = 0A$	1.5	3	mA (max)
I_{SD}	Shutdown Current	$V_{SHUTDOWN} = GND$	0.1	2.0	μA (max)
I_M	Mute Current	$V_{MUTE} = V_{DD}$	1.5	3	mA (max)
P_O	Output Power	THD = 1%; $f = 1kHz$			mW
		$R = 16\Omega$	25		
		$R = 32\Omega$	12		
V_{NO}	Output Noise Voltage	BW = 20 Hz to 20kHz, A-weighted	10		μV
PSRR	Power Supply Rejection Ratio	$V_{RIPPLE} = 200mV$ sine p-p	65		dB
T_{WU}	Wake Up Time from Shutdown		2		s
V_{OSD}	Output Voltage Change on Release from Shutdown			1	mV (max)
T_{UM}	Time to Un-Mute		0.01	0.02	s (max)
A_M	Mute Attenuation	$f = 1kHz$	80		db

Note 1: All voltages are measured with respect to the GND pin unless otherwise specified.

Note 2: Absolute Maximum Ratings indicate limits beyond which damage to the device may occur. Operating Ratings indicate conditions for which the device is functional but do not guarantee specific performance limits. Electrical Characteristics state DC and AC electrical specifications under particular test conditions which guarantee specific performance limits. This assumes that the device is within the Operating Ratings. Specifications are not guaranteed for parameters where no limit is given, however, the typical value is a good indication of device performance.

Note 3: The maximum power dissipation must be derated at elevated temperatures and is dictated by T_{JMAX} , θ_{JA} , and the ambient temperature, T_A . The maximum allowable power dissipation is $P_{DMAX} = (T_{JMAX} - T_A) / \theta_{JA}$ or the number given in Absolute Maximum Ratings, whichever is lower. For the LM4912, see power derating currents for more information.

Note 4: Human body model, 100pF discharged through a 1.5k Ω resistor.

Note 5: Machine Model, 220pF-240pF discharged through all pins.

Note 6: Typical values are measured at 25°C and represent the parametric norm.

Note 7: Limits are guaranteed to National's AOQL (Average Outgoing Quality Level).

Note 8: Datasheet min/max specification limits are guaranteed by design, test, or statistical analysis.

Note 9: 10 Ω Terminated input.

External Components Description

See (Figure 1)

Components		Functional Description
1.	R_I	Inverting input resistance which sets the closed-loop gain in conjunction with R_f . This resistor also forms a high-pass filter with C_I at $f_c = 1/(2\pi R_I C_I)$.
2.	C_I	Input coupling capacitor which blocks the DC voltage at the amplifier's input terminals. Also creates a high-pass filter with R_I at $f_c = 1/(2\pi R_I C_I)$. Refer to the section Proper Selection of External Components , for an explanation of how to determine the value of C_I .
3.	R_f	Feedback resistance which sets the closed-loop gain in conjunction with R_I .
4.	C_S	Supply bypass capacitor which provides power supply filtering. Refer to the Power Supply Bypassing section for information concerning proper placement and selection of the supply bypass capacitor.
5.	C_B	Bypass pin capacitor which provides half-supply filtering. Refer to the section, Proper Selection of Proper Components , for information concerning proper placement and selection of C_B .
6.	C_O	Output coupling capacitor which blocks the DC voltage at the amplifier's output. Forms a high pass filter with R_L at $f_o = 1/(2\pi R_L C_O)$.

Typical Performance Characteristics

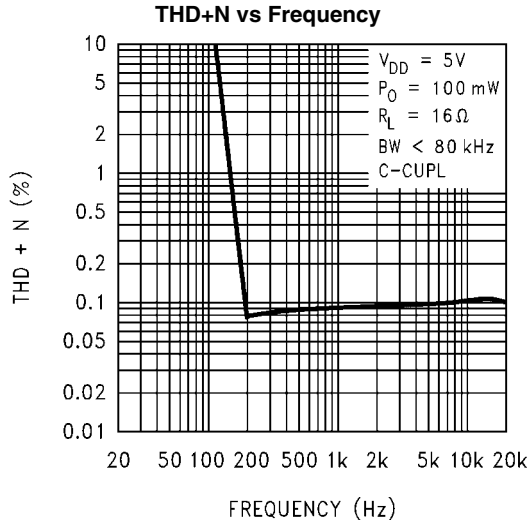

20048184

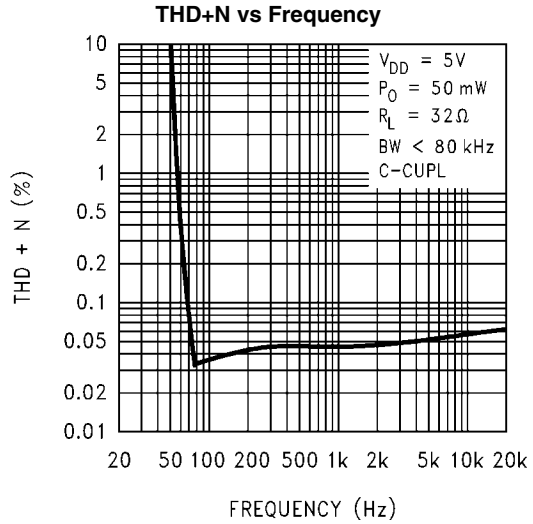

20048185

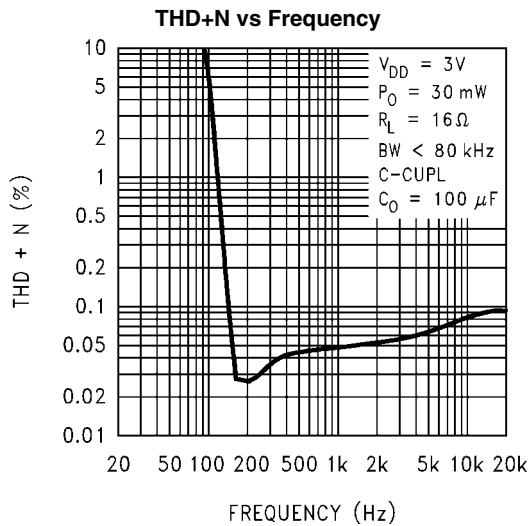

20048186

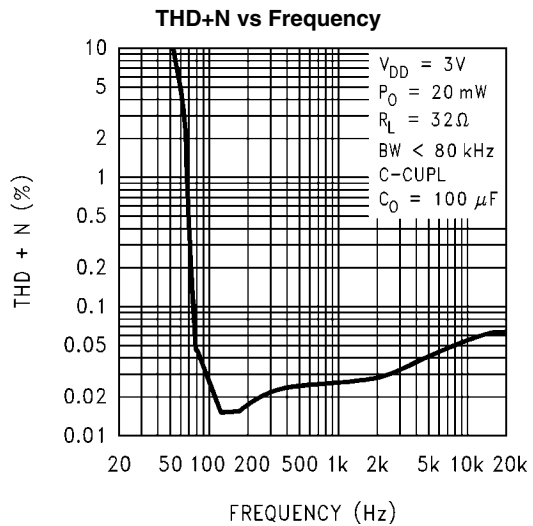

20048187

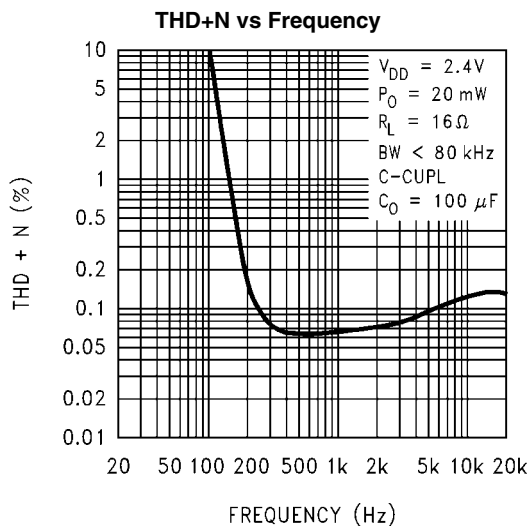

20048188

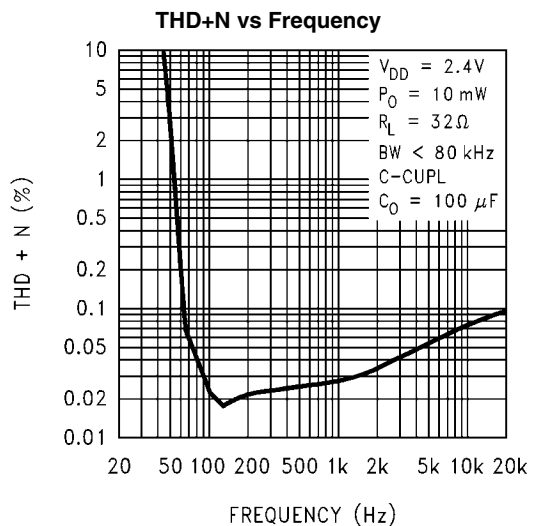

20048189

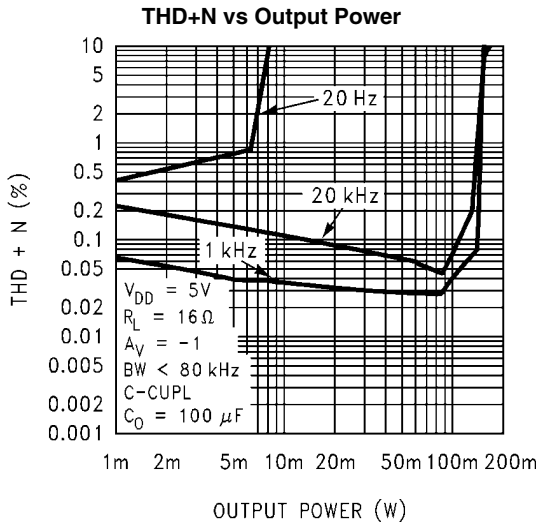

20048190

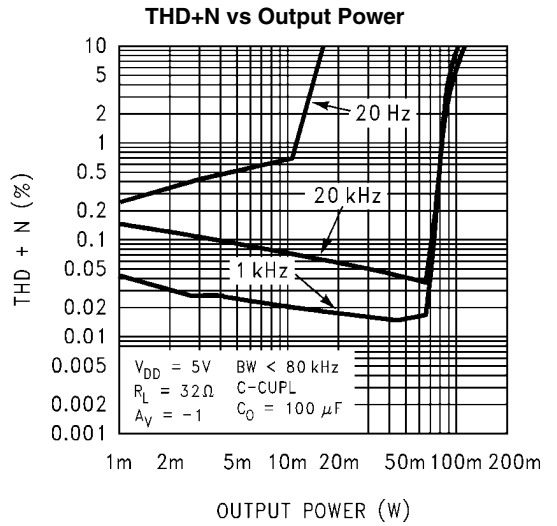

20048191

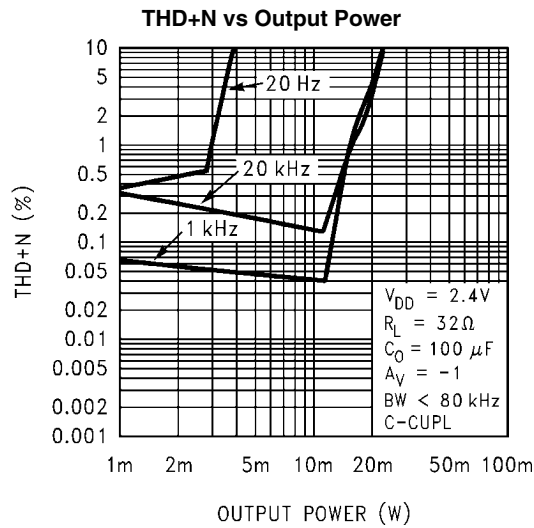

20048108

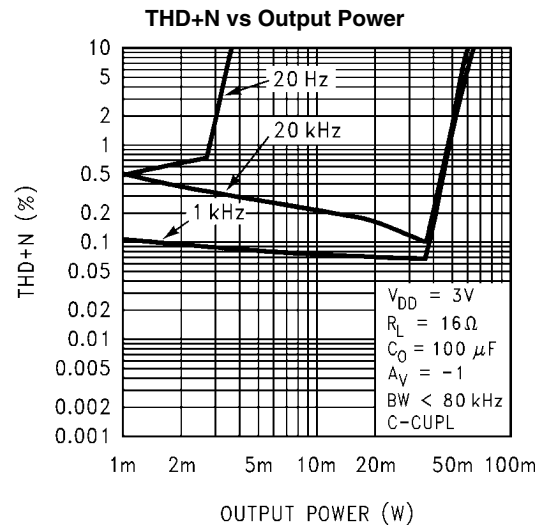

20048107

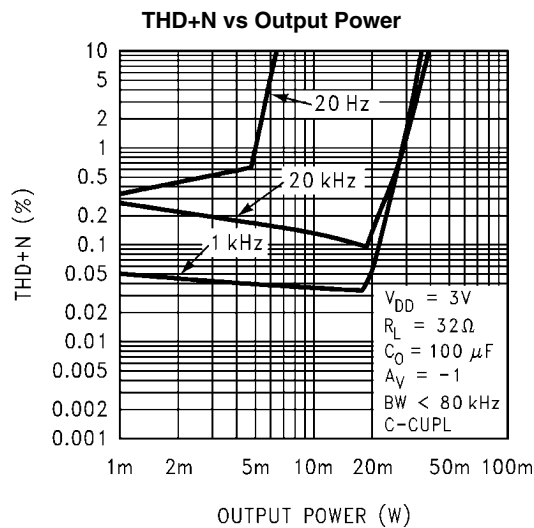

20048110

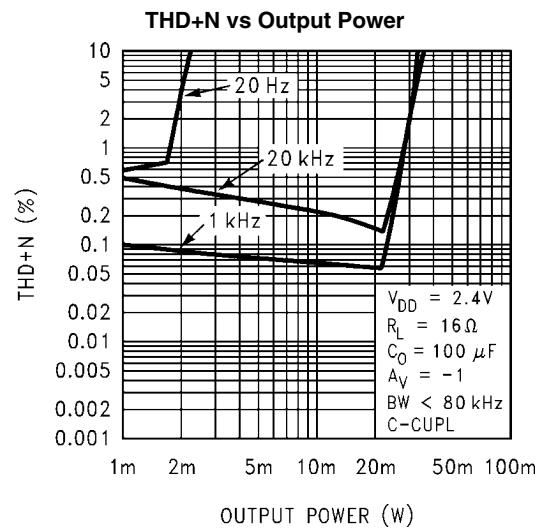

20048109

Output Resistance vs Load Resistance

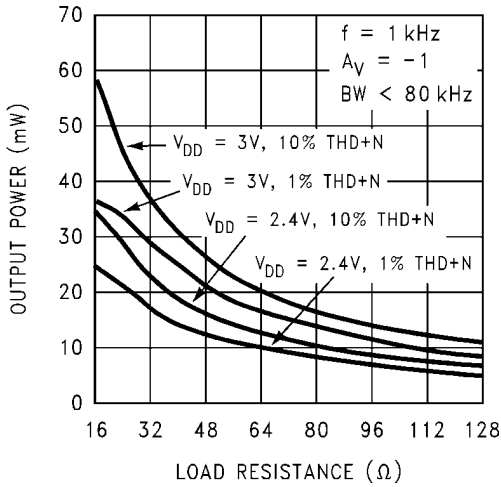

20048113

Output Power vs Supply Voltage

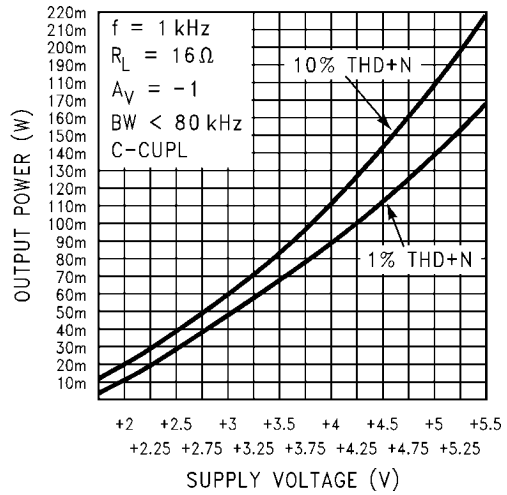

20048112

Output Power vs Supply Voltage

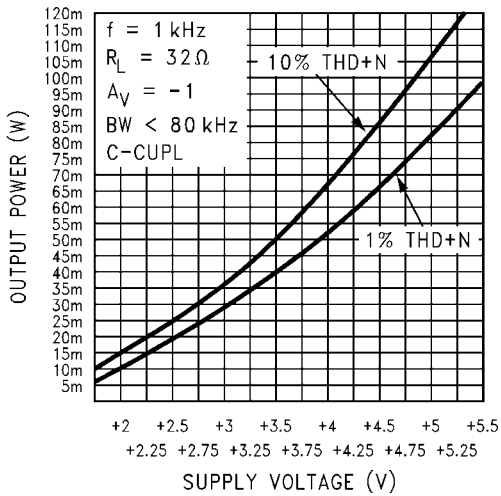

20048111

Output Power vs Load Resistance

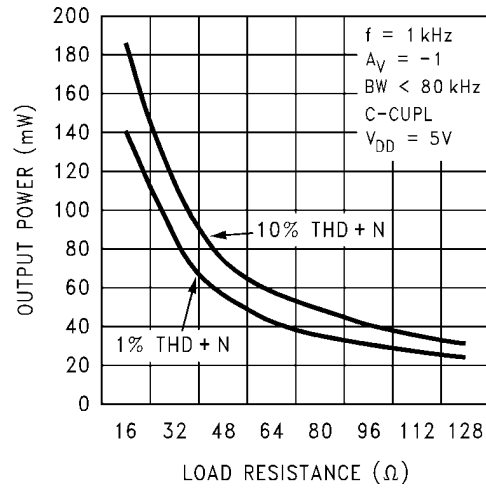

20048196

Power Dissipation vs. Output Power

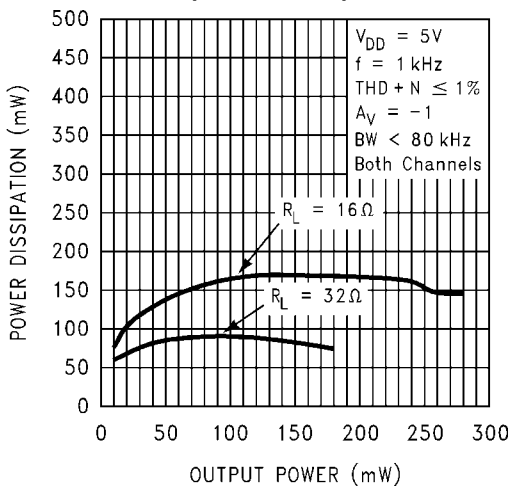

20048198

Power Dissipation vs. Output Power

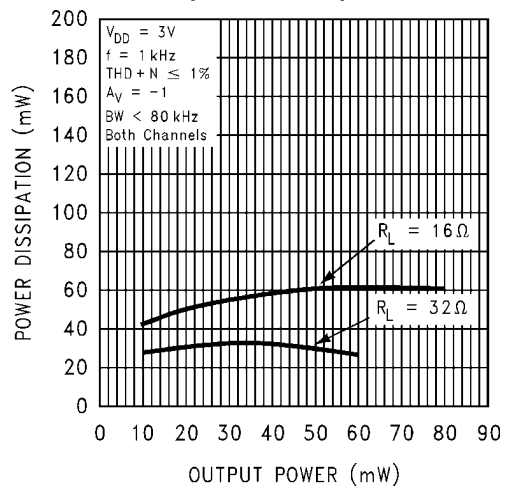

20048199

Power Dissipation vs Output Power

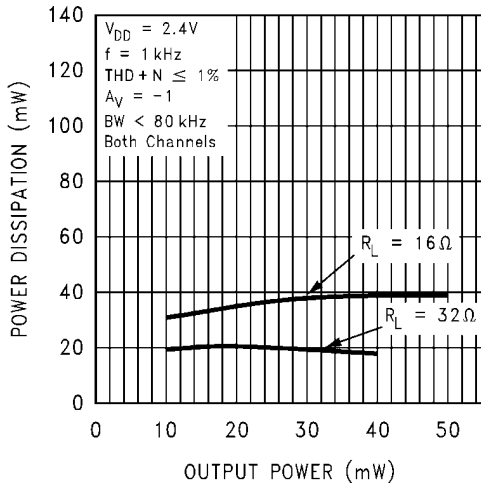

Channel Separation

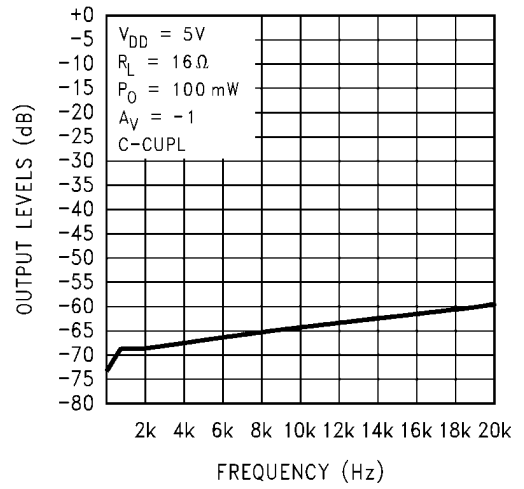

Channel Separation

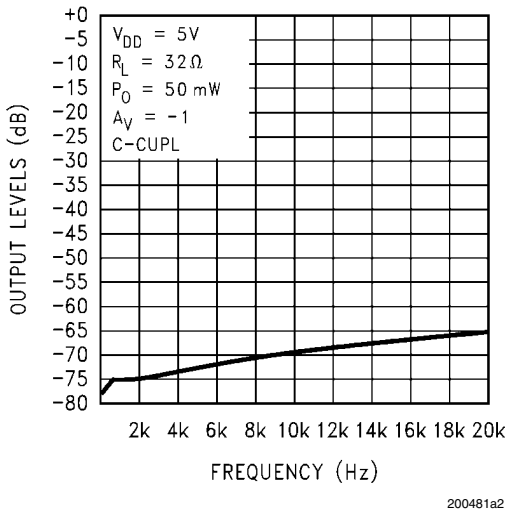

Channel Separation

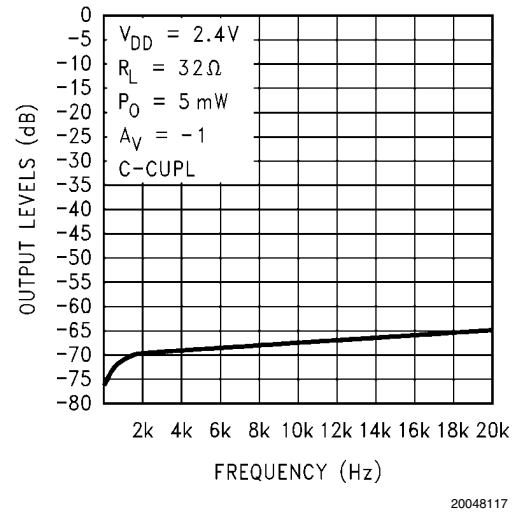

Channel Separation

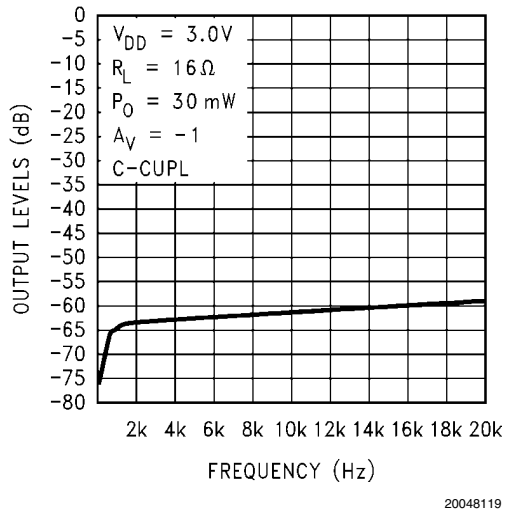

Channel Separation

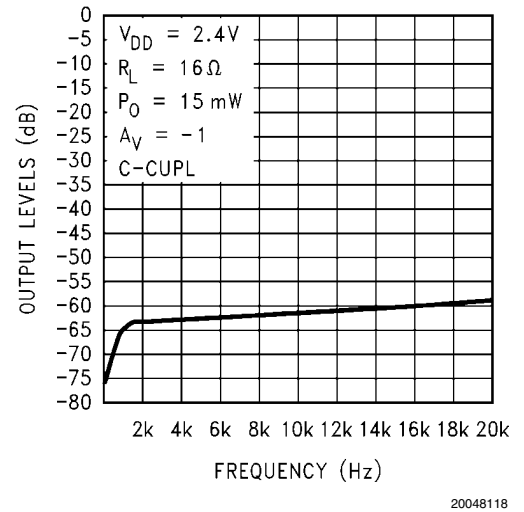

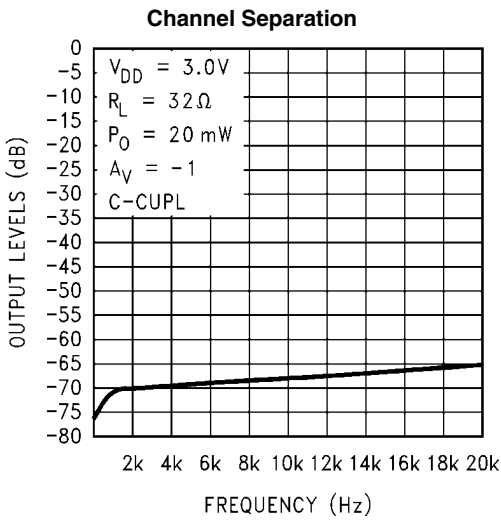

20048116

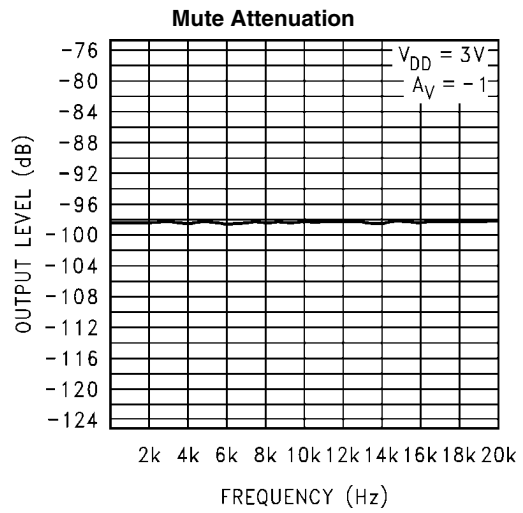

200481b4

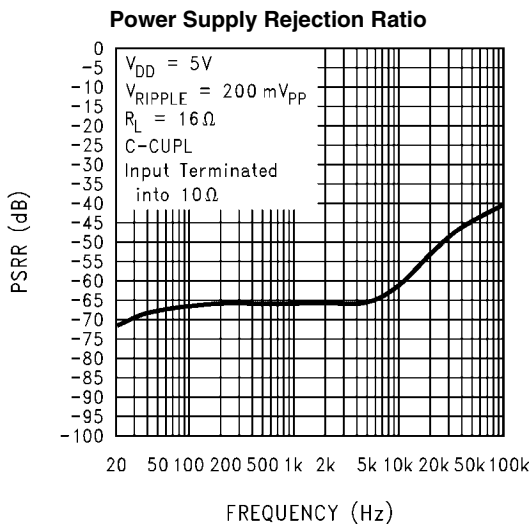

200481a3

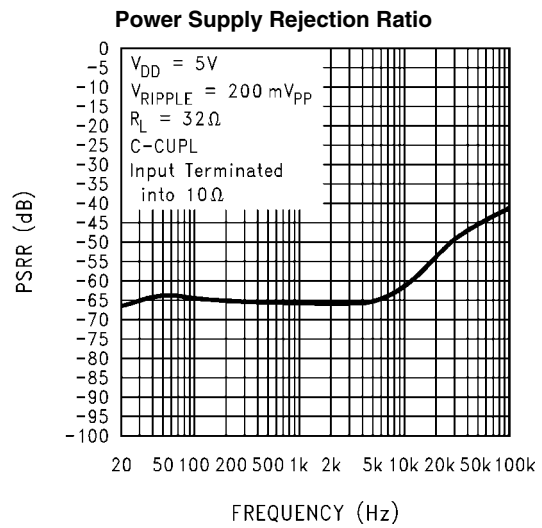

200481a4

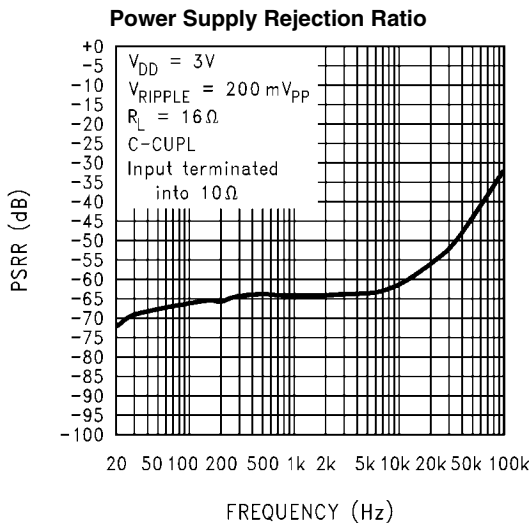

20048120

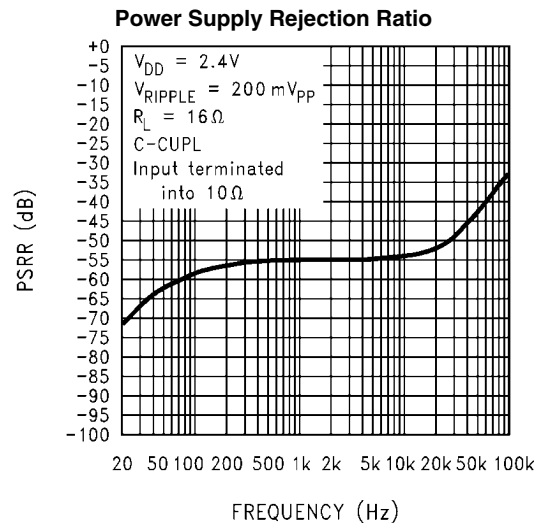

20048123

Power Supply Rejection Ratio

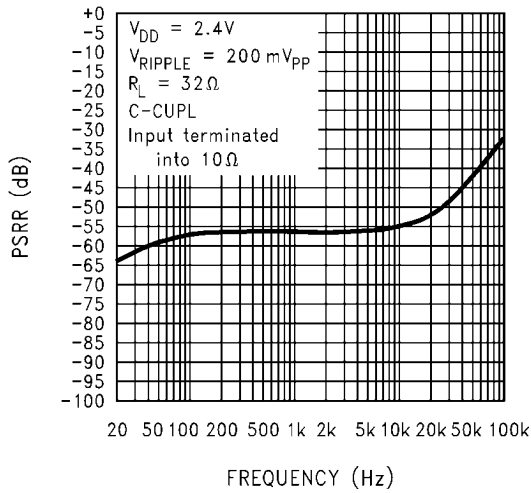

20048121

Power Supply Rejection Ratio

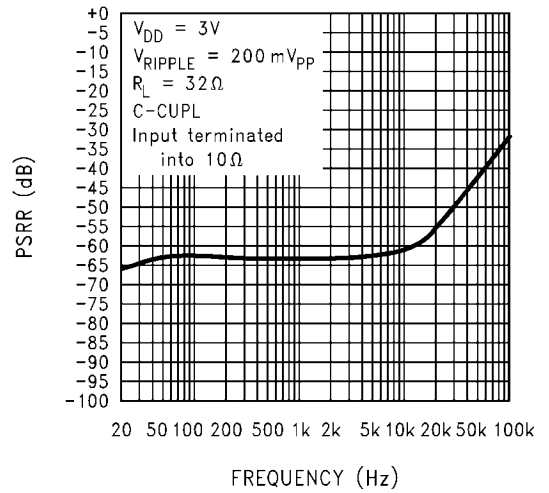

20048122

Frequency Response vs Input Capacitor Size

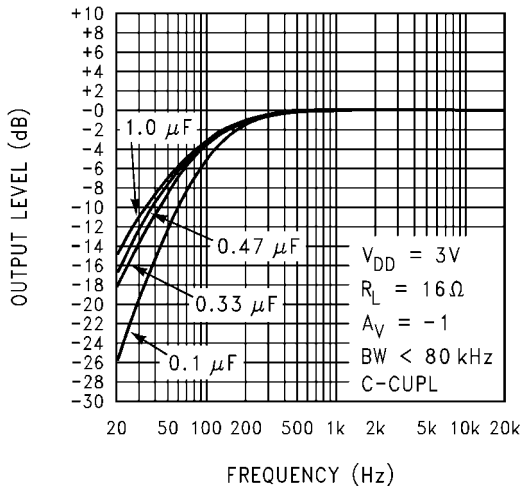

20048127

Open Loop Frequency Response

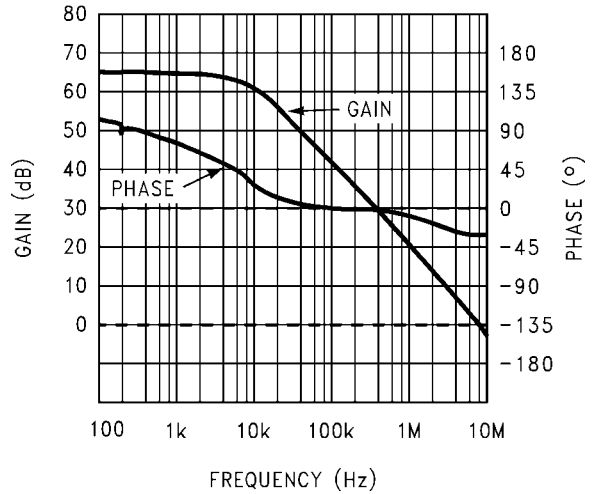

200481a7

Supply Voltage vs Supply Current

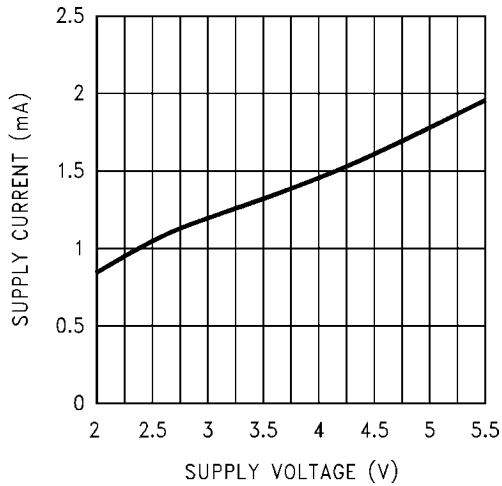

20048124

Clipping Voltage vs Supply Voltage

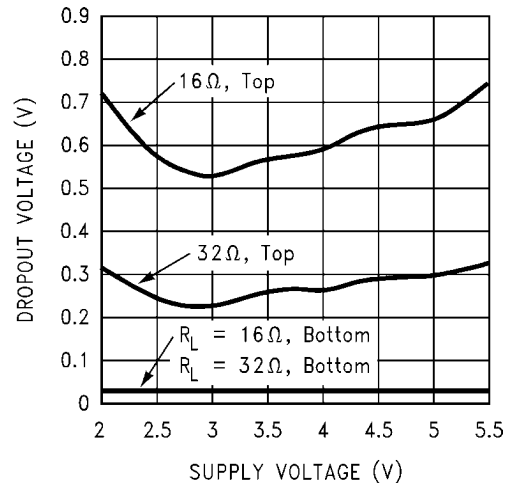

20048125

Noise Floor

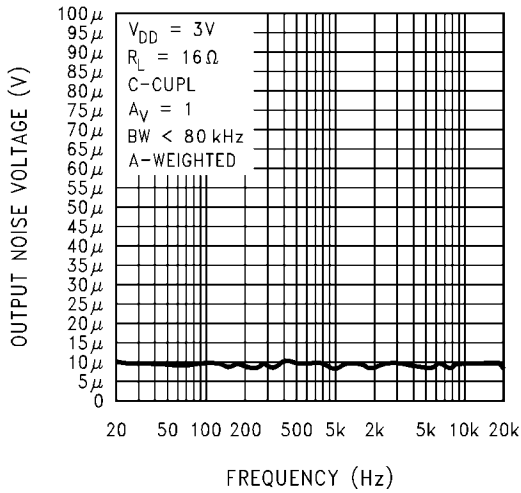

200481a8

Shutdown Hysteresis Voltage, Vdd=5V

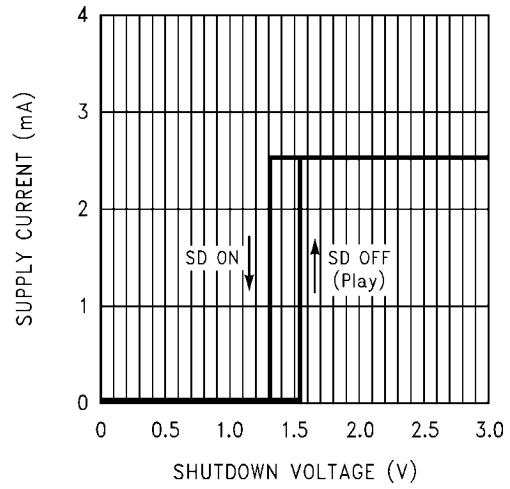

200481b1

Shutdown Hysteresis Voltage, Vdd=3V

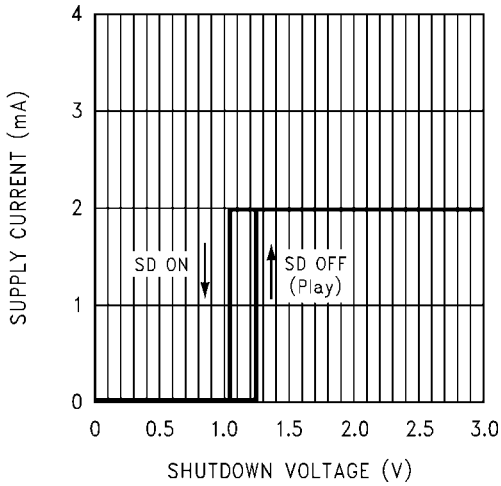

200481b2

Power Derating Curve

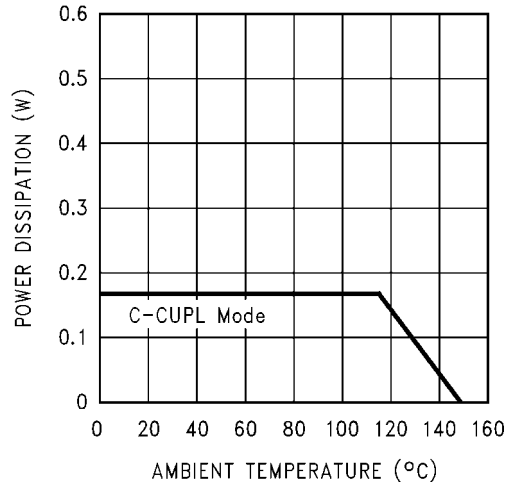

200481b3

Application Information

AMPLIFIER CONFIGURATION EXPLANATION

As shown in Figure 1, the LM4912 has three operational amplifiers internally. Two of the amplifiers have externally configurable gain while the other amplifier is internally fixed at the bias point acting as a unity-gain buffer. The closed-loop gain of the two configurable amplifiers is set by selecting the ratio of R_f to R_i . Consequently, the gain for each channel of the IC is

$$A_{VD} = -(R_f / R_i)$$

By driving the loads through outputs V_{oA} and V_{oB} with V_{oC} acting as a buffered bias voltage the LM4912 does not require output coupling capacitors. The classical single-ended amplifier configuration where one side of the load is connected to ground requires large, expensive output coupling capacitors.

A configuration, such as the one used in the LM4912, has a major advantage over single supply, single-ended amplifiers. Since the outputs V_{oA} , V_{oB} , and V_{oC} are all biased at $1/2 V_{DD}$, no net DC voltage exists across each load. This eliminates the need for output coupling capacitors which are required in a single-supply, single-ended amplifier configuration. Without output coupling capacitors in a typical single-supply, single-ended amplifier, the bias voltage is placed across the load resulting in both increased internal IC power dissipation and possible loudspeaker damage.

POWER DISSIPATION

Power dissipation is a major concern when using any power amplifier and must be thoroughly understood to ensure a successful design. When operating in capacitor-coupled mode, Equation 1 states the maximum power dissipation point for a single-ended amplifier operating at a given supply voltage and driving a specified output load.

$$P_{DMAX} = (V_{DD})^2 / (2\pi^2 R_L) \quad (1)$$

Since the LM4912 has two operational amplifiers in one package, the maximum internal power dissipation point is twice that of the number which results from Equation 1. From Equation 1, assuming a 3V power supply and a 32Ω load, the maximum power dissipation point is 14mW per amplifier. Thus the maximum package dissipation point is 28mW.

The maximum power dissipation point obtained from Equation 1 must not be greater than the power dissipation that results from Equation 2:

$$P_{DMAX} = (T_{JMAX} - T_A) / \theta_{JA} \quad (2)$$

For package MUB10A, $\theta_{JA} = 190^\circ\text{C/W}$. $T_{JMAX} = 150^\circ\text{C}$ for the LM4912. Depending on the ambient temperature, T_A , of the system surroundings, Equation 2 can be used to find the maximum internal power dissipation supported by the IC packaging. If the result of Equation 1 is greater than that of Equation 2, then either the supply voltage must be decreased, the load impedance increased or T_A reduced. For the typical application of a 3V power supply, with an 32Ω load, the maximum ambient temperature possible without violating the

maximum junction temperature is approximately 144°C provided that device operation is around the maximum power dissipation point. Thus, for typical applications, power dissipation is not an issue. Power dissipation is a function of output power and thus, if typical operation is not around the maximum power dissipation point, the ambient temperature may be increased accordingly. Refer to the Typical Performance Characteristics curves for power dissipation information for lower output powers.

POWER SUPPLY BYPASSING

As with any amplifier, proper supply bypassing is important for low noise performance and high power supply rejection. The capacitor location on the power supply pins should be as close to the device as possible.

Typical applications employ a 3V regulator with 10mF tantalum or electrolytic capacitor and a ceramic bypass capacitor which aid in supply stability. This does not eliminate the need for bypassing the supply nodes of the LM4912. A bypass capacitor value in the range of $0.1\mu\text{F}$ to $1\mu\text{F}$ is recommended for C_S .

MICRO POWER SHUTDOWN

The voltage applied to the SHUTDOWN pin controls the LM4912's shutdown function. Activate micro-power shutdown by applying a logic-low voltage to the SHUTDOWN pin. When active, the LM4912's micro-power shutdown feature turns off the amplifier's bias circuitry, reducing the supply current. The trigger point varies depending on supply voltage and is shown in the Shutdown Hysteresis Voltage graphs in the Typical Performance Characteristics section. The low $0.1\mu\text{A}(\text{typ})$ shutdown current is achieved by applying a voltage that is as near as ground as possible to the SHUTDOWN pin. A voltage that is higher than ground may increase the shutdown current. There are a few ways to control the micro-power shutdown. These include using a single-pole, single-throw switch, a microprocessor, or a microcontroller. When using a switch, connect an external $100\text{k}\Omega$ pull-up resistor between the SHUTDOWN pin and V_{DD} . Connect the switch between the SHUTDOWN pin and ground. Select normal amplifier operation by opening the switch. Closing the switch connects the SHUTDOWN pin to ground, activating micro-power shutdown.

The switch and resistor guarantee that the SHUTDOWN pin will not float. This prevents unwanted state changes. In a system with a microprocessor or microcontroller, use a digital output to apply the control voltage to the SHUTDOWN pin. Driving the SHUTDOWN pin with active circuitry eliminates the pull-up resistor.

Shutdown enable/disable times are controlled by a combination of C_B and V_{DD} . Larger values of C_B results in longer turn on/off times from Shutdown. Smaller V_{DD} values also increase turn on/off time for a given value of C_B . Longer shutdown times also improve the LM4912's resistance to click and pop upon entering or returning from shutdown. For a 2.4V supply and $C_B = 4.7\mu\text{F}$, the LM4912 requires about 2 seconds to enter or return from shutdown. This longer shutdown time enables the LM4912 to have virtually zero pop and click transients upon entering or release from shutdown.

Smaller values of C_B will decrease turn-on time, but at the cost of increased pop and click and reduced PSRR. Since shutdown enable/disable times increase dramatically as supply voltage gets below 2.2V, this reduced turn-on time may be desirable if extreme low supply voltage levels are used as this would offset increases in turn-on time caused by the lower supply voltage.

MUTE

When in C-CUPL mode, the LM4912 also features a mute function that is independent of load impedance and enables extremely fast turn-on/turn-off with a minimum of output pop and click. The mute function leaves the outputs at their bias level, thus resulting in higher power consumption than shutdown mode, but also provides much faster turn on/off times. Mute mode is enabled by providing a logic high signal on the MUTE pin in the opposite manner as the shutdown function described above. Threshold voltages and activation techniques match those given for the shutdown function as well. Additionally, Mute should not be enabled during shutdown or while entering or returning from shutdown. This is not a valid operation condition and may result in much higher pop and click values.

PROPER SELECTION OF EXTERNAL COMPONENTS

Proper selection of external components in applications using integrated power amplifiers is critical to optimize device and system performance. While the LM4912 is tolerant of external component combinations, consideration to component values must be used to maximize overall system quality.

The LM4912 is unity-gain stable which gives the designer maximum system flexibility. The LM4912 should be used in low gain configurations to minimize THD+N values, and maximize the signal to noise ratio. Low gain configurations require large input signals to obtain a given output power. Input signals equal to or greater than $1V_{rms}$ are available from sources such as audio codecs. Very large values should not be used for the gain-setting resistors. Values for R_i and R_f should be less than $1M\Omega$. Please refer to the section, **Audio Power Amplifier Design**, for a more complete explanation of proper gain selection.

Besides gain, one of the major considerations is the closed-loop bandwidth of the amplifier. To a large extent, the bandwidth is dictated by the choice of external components shown in Figures 2 and 3. The input coupling capacitor, C_i , forms a first order high pass filter which limits low frequency response. This value should be chosen based on needed frequency response and turn-on time.

SELECTION OF INPUT CAPACITOR SIZE

Amplifying the lowest audio frequencies requires a high value input coupling capacitor, C_i . A high value capacitor can be expensive and may compromise space efficiency in portable designs. In many cases, however, the headphones used in portable systems have little ability to reproduce signals below 60Hz. Applications using headphones with this limited frequency response reap little improvement by using a high value input capacitor.

In addition to system cost and size, turn on time is affected by the size of the input coupling capacitor C_i . A larger input coupling capacitor requires more charge to reach its quiescent DC voltage. This charge comes from the output via the feedback. Thus, by minimizing the capacitor size based on nec-

essary low frequency response, turn-on time can be minimized. A small value of C_i (in the range of $0.1\mu F$ to $0.39\mu F$), is recommended.

AUDIO POWER AMPLIFIER DESIGN

A 25mW/32 Ω Audio Amplifier

Given:

Power Output	25mWrms
Load Impedance	32 Ω
Input Level	1Vrms
Input Impedance	20k Ω

A designer must first determine the minimum supply rail to obtain the specified output power. By extrapolating from the Output Power vs Supply Voltage graphs in the **Typical Performance Characteristics** section, the supply rail can be easily found.

3V is a standard voltage in most applications, it is chosen for the supply rail. Extra supply voltage creates headroom that allows the LM4912 to reproduce peak in excess of 25mW without producing audible distortion. At this time, the designer must make sure that the power supply choice along with the output impedance does not violate the conditions explained in the **Power Dissipation** section.

Once the power dissipation equations have been addressed, the required gain can be determined from Equation 2.

$$A_V \geq \sqrt{(P_O R_L)} / (V_{IN}) = V_{Orms} / V_{inrms} \quad (3)$$

From Equation 4, the minimum A_V is 0.89; use $A_V = 1$. Since the desired input impedance is 20k Ω , and with a A_V gain of 1, a ratio of 1:1 results from Equation 1 for R_i to R_f . The values are chosen with $R_i = 20k\Omega$ and $R_f = 20k\Omega$. The final design step is to address the bandwidth requirements which must be stated as a pair of -3dB frequency points. Five times away from a -3dB point is 0.17dB down from passband response which is better than the required ± 0.25 dB specified.

$$f_L = 100\text{Hz}/5 = 20\text{Hz}$$

$$f_H = 20\text{kHz} * 5 = 100\text{kHz}$$

As stated in the **External Components** section, R_i in conjunction with C_i creates a

$$C_i \geq 1 / (2\pi * 20k\Omega * 20\text{Hz}) = 0.397\mu F; \text{ use } 0.39\mu F.$$

The high frequency pole is determined by the product of the desired frequency pole, f_H , and the differential gain, A_V . With an $A_V = 1$ and $f_H = 100\text{kHz}$, the resulting GBWP = 100kHz which is much smaller than the LM4912 GBWP of 10MHz. This figure displays that is a designer has a need to design an amplifier with higher differential gain, the LM4912 can still be used without running into bandwidth limitations.

Revision History

Rev	Date	Description
1.0	7/15/05	Fixed spelling typos.
1.01	06/16/08	Fixed a typo.

Notes

LM4912

Notes

For more National Semiconductor product information and proven design tools, visit the following Web sites at:

Products		Design Support	
Amplifiers	www.national.com/amplifiers	WEBENCH	www.national.com/webench
Audio	www.national.com/audio	Analog University	www.national.com/AU
Clock Conditioners	www.national.com/timing	App Notes	www.national.com/appnotes
Data Converters	www.national.com/adc	Distributors	www.national.com/contacts
Displays	www.national.com/displays	Green Compliance	www.national.com/quality/green
Ethernet	www.national.com/ethernet	Packaging	www.national.com/packaging
Interface	www.national.com/interface	Quality and Reliability	www.national.com/quality
LVDS	www.national.com/lvds	Reference Designs	www.national.com/refdesigns
Power Management	www.national.com/power	Feedback	www.national.com/feedback
Switching Regulators	www.national.com/switchers		
LDOs	www.national.com/ldo		
LED Lighting	www.national.com/led		
PowerWise	www.national.com/powerwise		
Serial Digital Interface (SDI)	www.national.com/sdi		
Temperature Sensors	www.national.com/tempsensors		
Wireless (PLL/VCO)	www.national.com/wireless		

THE CONTENTS OF THIS DOCUMENT ARE PROVIDED IN CONNECTION WITH NATIONAL SEMICONDUCTOR CORPORATION ("NATIONAL") PRODUCTS. NATIONAL MAKES NO REPRESENTATIONS OR WARRANTIES WITH RESPECT TO THE ACCURACY OR COMPLETENESS OF THE CONTENTS OF THIS PUBLICATION AND RESERVES THE RIGHT TO MAKE CHANGES TO SPECIFICATIONS AND PRODUCT DESCRIPTIONS AT ANY TIME WITHOUT NOTICE. NO LICENSE, WHETHER EXPRESS, IMPLIED, ARISING BY ESTOPPEL OR OTHERWISE, TO ANY INTELLECTUAL PROPERTY RIGHTS IS GRANTED BY THIS DOCUMENT.

TESTING AND OTHER QUALITY CONTROLS ARE USED TO THE EXTENT NATIONAL DEEMS NECESSARY TO SUPPORT NATIONAL'S PRODUCT WARRANTY. EXCEPT WHERE MANDATED BY GOVERNMENT REQUIREMENTS, TESTING OF ALL PARAMETERS OF EACH PRODUCT IS NOT NECESSARILY PERFORMED. NATIONAL ASSUMES NO LIABILITY FOR APPLICATIONS ASSISTANCE OR BUYER PRODUCT DESIGN. BUYERS ARE RESPONSIBLE FOR THEIR PRODUCTS AND APPLICATIONS USING NATIONAL COMPONENTS. PRIOR TO USING OR DISTRIBUTING ANY PRODUCTS THAT INCLUDE NATIONAL COMPONENTS, BUYERS SHOULD PROVIDE ADEQUATE DESIGN, TESTING AND OPERATING SAFEGUARDS.

EXCEPT AS PROVIDED IN NATIONAL'S TERMS AND CONDITIONS OF SALE FOR SUCH PRODUCTS, NATIONAL ASSUMES NO LIABILITY WHATSOEVER, AND NATIONAL DISCLAIMS ANY EXPRESS OR IMPLIED WARRANTY RELATING TO THE SALE AND/OR USE OF NATIONAL PRODUCTS INCLUDING LIABILITY OR WARRANTIES RELATING TO FITNESS FOR A PARTICULAR PURPOSE, MERCHANTABILITY, OR INFRINGEMENT OF ANY PATENT, COPYRIGHT OR OTHER INTELLECTUAL PROPERTY RIGHT.

LIFE SUPPORT POLICY

NATIONAL'S PRODUCTS ARE NOT AUTHORIZED FOR USE AS CRITICAL COMPONENTS IN LIFE SUPPORT DEVICES OR SYSTEMS WITHOUT THE EXPRESS PRIOR WRITTEN APPROVAL OF THE CHIEF EXECUTIVE OFFICER AND GENERAL COUNSEL OF NATIONAL SEMICONDUCTOR CORPORATION. As used herein:

Life support devices or systems are devices which (a) are intended for surgical implant into the body, or (b) support or sustain life and whose failure to perform when properly used in accordance with instructions for use provided in the labeling can be reasonably expected to result in a significant injury to the user. A critical component is any component in a life support device or system whose failure to perform can be reasonably expected to cause the failure of the life support device or system or to affect its safety or effectiveness.

National Semiconductor and the National Semiconductor logo are registered trademarks of National Semiconductor Corporation. All other brand or product names may be trademarks or registered trademarks of their respective holders.

Copyright© 2008 National Semiconductor Corporation

For the most current product information visit us at www.national.com



National Semiconductor Americas Technical Support Center
Email: support@nsc.com
Tel: 1-800-272-9959

National Semiconductor Europe Technical Support Center
Email: europe.support@nsc.com
German Tel: +49 (0) 180 5010 771
English Tel: +44 (0) 870 850 4288

National Semiconductor Asia Pacific Technical Support Center
Email: ap.support@nsc.com

National Semiconductor Japan Technical Support Center
Email: jpn.feedback@nsc.com



Looking for pricing, stock, or lifecycle information?

Click below to explore more details on WIN SOURCE:

 [View LM4912MMX on WIN SOURCE](#)

 [Texas Instruments](#) Information

Optimize Your Supply Chain with WIN SOURCE Solutions

-  Global Sourcing Solution
-  Obsolete Management
-  Cost Control Management
-  Shortage Management
-  Alternative Solution
-  Excess Inventory Management