



**THE DATASHEET OF
LM48901RL/NOPB**



LM48901 Boomer® Audio Power Amplifier Series Quad Class D Spatial Array

 Check for Samples: [LM48901](#)

FEATURES

- Spatial Sound Processing
- I²S Compatible Input
- Differential-Input Stereo ADC
- Edge Rate Control Reduces EMI while Preserving Audio Quality and Efficiency
- Paralleled Output Mode
- Short Circuit and Thermal Overload Protection
- Minimum external components
- Click and Pop suppression
- Micro-power shutdown

- Available in space-saving micro SMD and LLP packages

APPLICATIONS

- Laptops
- Tablets
- Desktop Computers
- Sound Bars
- Multimedia Devices
- MP3 Player Accessories
- Docking Stations

DESCRIPTION

The LM48901 is a quad Class D amplifier that utilizes Texas Instruments' proprietary spatial sound processor to create an enhanced sound stage for portable multimedia devices. The Class D output stages feature Texas Instruments' edge rate control (ERC) PWM architecture that significantly reduces RF emissions while preserving audio quality and efficiency.

The LM48901's flexible I²S interface is compatible with standard serial audio interfaces. A stereo differential-input ADC gives the device the ability to process analog stereo audio signals.

The LM48901 is configured through an I²C compatible interface and is capable of delivering 2.8W/channel of continuous output power into an 4Ω load with less than 10% THD+N. A 2.1 mode pairs two output drivers in parallel, increasing current drive for 4Ω loads.

Output short circuit and thermal overload protection prevent the device from being damaged during fault conditions. Superior click and pop suppression eliminates audible transients on power-up/down and during shutdown. The LM48901 is available in space saving microSMD and LLP packages.

Table 1. Key Specifications

		VALUE	UNIT
SNR (A-Weighted)		87	dBA (typ)
Output Power/channel, PV _{DD} = 5V	R _L = 8Ω, THD+N ≤10%	1.7	W (typ)
	R _L = 4Ω, THD+N ≤10%	2.8	
THD+N		0.06% (typ)	
Efficiency/Channel		89% (typ)	
PSRR at 217Hz		71	dB (typ)
Shutdown current 1 μA (typ)		1	μA (typ)



Please be aware that an important notice concerning availability, standard warranty, and use in critical applications of Texas Instruments semiconductor products and disclaimers thereto appears at the end of this data sheet.

All trademarks are the property of their respective owners.

Typical Application

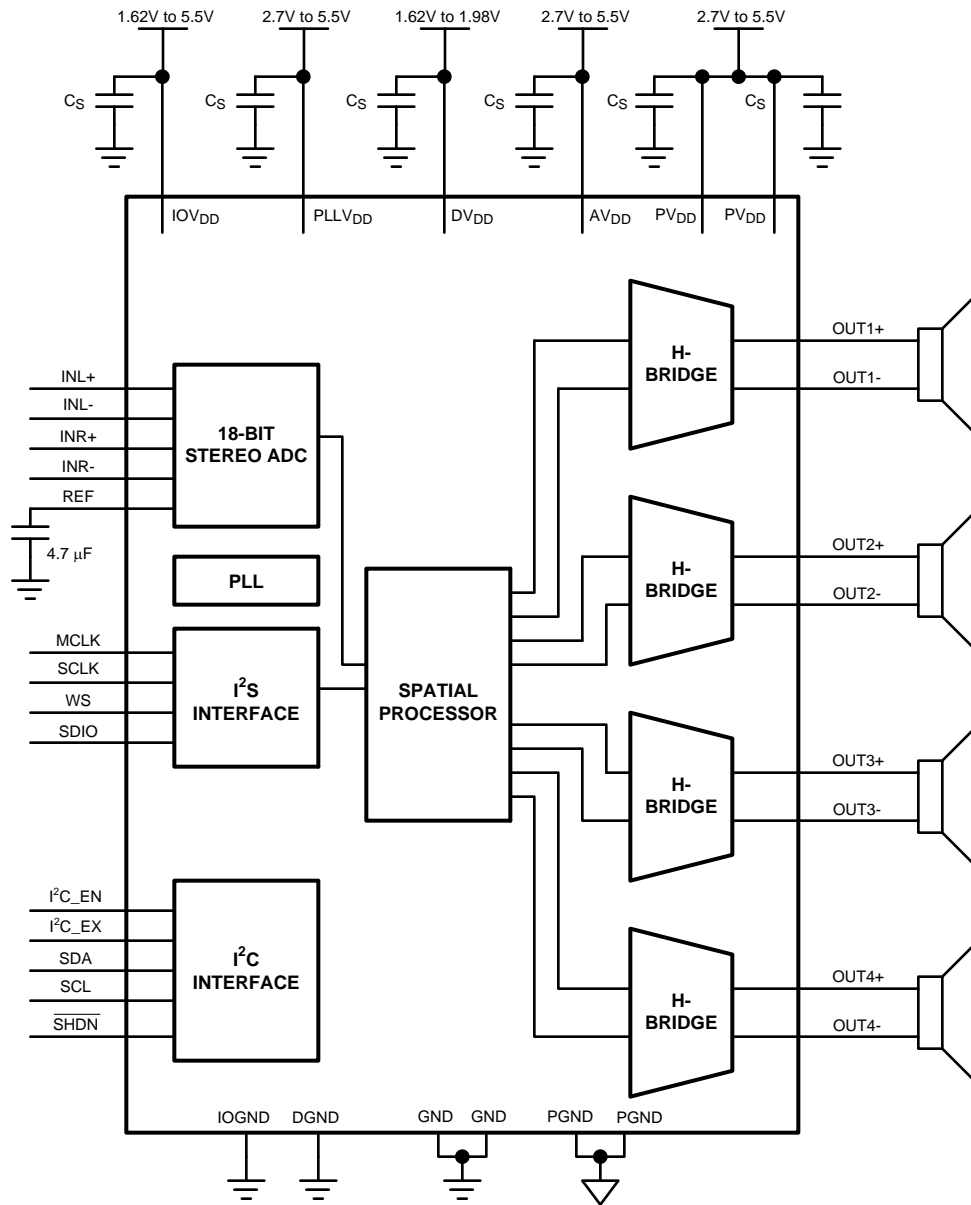

Figure 1. Typical Audio Amplifier Application Circuit

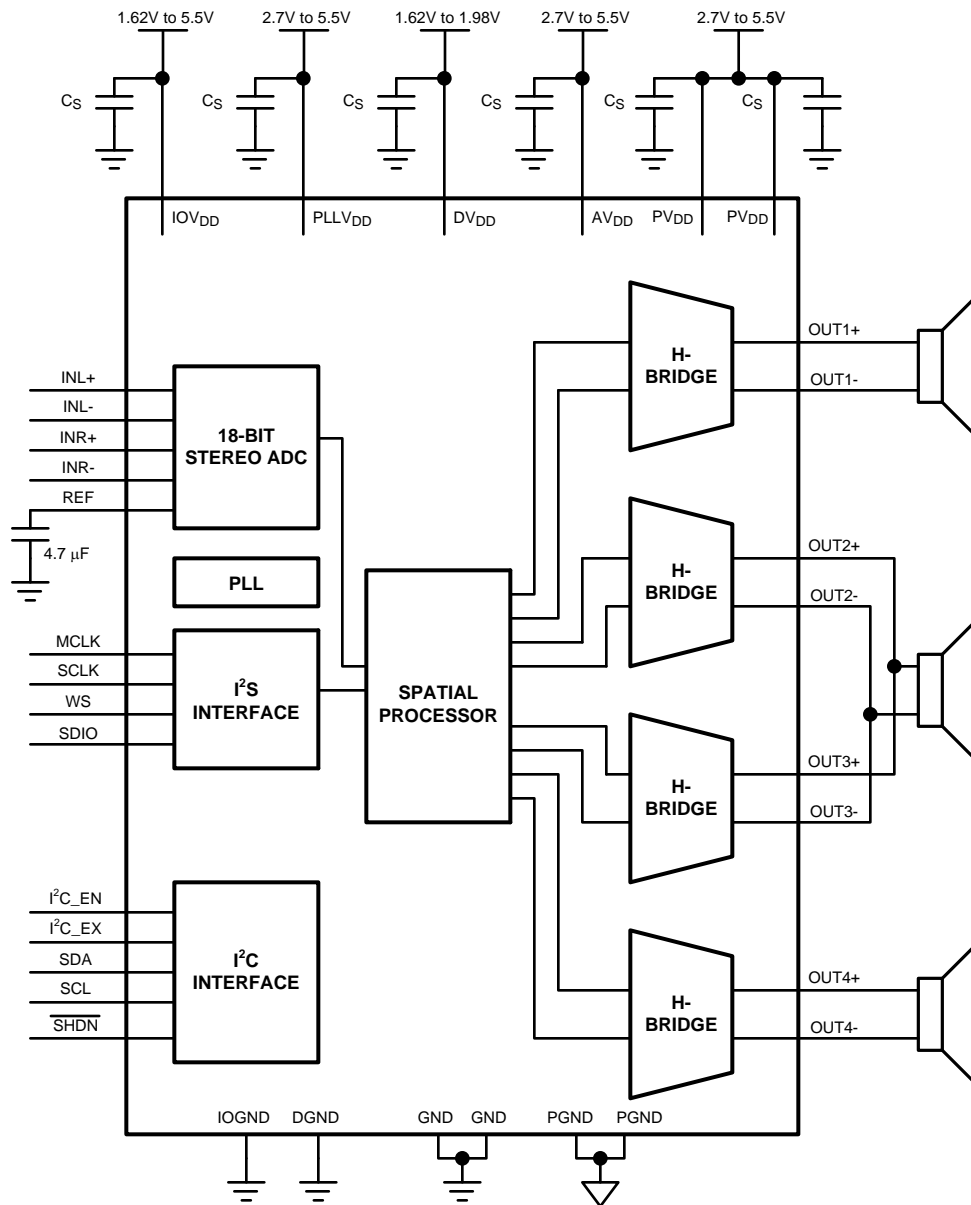

Figure 2. Channel Audio Amplifier Application Circuit

Only OUT2 and OUT3 can be configured in parallel. OUT1 and OUT4 cannot be configured in parallel.

Connection Diagram

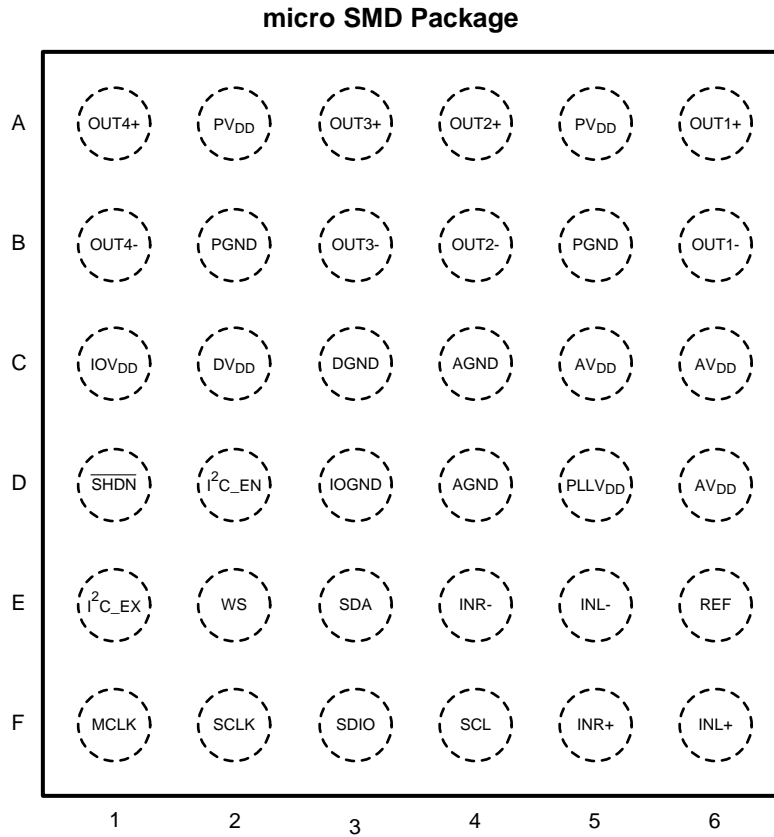

Figure 3. Top View

36-Bump micro SMD Marking

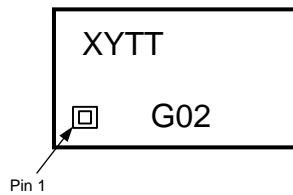

Figure 4. Top View
XY = Date code
TT = Die traceability
G = Boomer Family
02 = LM48901RL

SQ Package

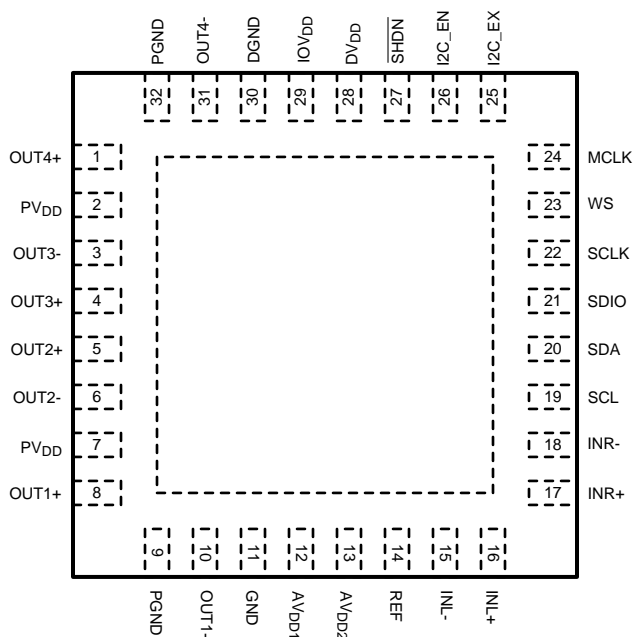

Figure 5. Top View

Table 2. Pin Descriptions

BUMP	PIN	NAME	DESCRIPTION
A1	1	OUT4+	Channel 4 Non-Inverting Output
A2, A5	2, 7	PVDD	Class D Power Supply
A3	4	OUT3+	Channel 3 Non-Inverting Output. Connect to OUT2+ in Parallel Mode.
A4	5	OUT2+	Channel 2 Non-Inverting Output. Connect to OUT3+ in Parallel Mode.
A6	8	OUT1+	Channel 1 Non-Inverting Output
B1	31	OUT4-	Channel 4 Inverting Output
B2, B5	9, 32	PGND	Power Ground
B3	3	OUT3-	Channel 3 Inverting Output. Connect to OUT2- in Parallel Mode.
B4	6	OUT2-	Channel 2 Inverting Output. Connect to OUT3- in Parallel Mode.
B6	10	OUT1-	Channel 1 Inverting Output
C1	29	IOVDD	Digital Interface Power Supply
C2	28	DVDD	Digital Power Supply
C3	30	DGND	Digital Ground
C4	11	AGND1	Modulator Analog Ground
C5	—	AVDD3	ADC Reference Power Supply
C6	12	AVDD1	Modulator Analog Power Supply. Set to same voltage as PV _{DD} for maximum headroom.
D1	27	SHDN	Active Low Shutdown. Connect to V _{DD} for normal operation.
D2	26	I ² C_EN	I ² C Enable Input
D3	30	IOGND	Digital Interface Ground
D4	—	AGND2	ADC Analog Ground

Table 2. Pin Descriptions (continued)

BUMP	PIN	NAME	DESCRIPTION
D5	—	PLLV _{DD}	PLL Power Supply
D6	13	AVDD2	ADC Analog Power Supply
E1	25	I ² C_EX	I ² C Enable Output
E2	23	WS	I ² S Word Select Input
E3	20	SDA	I ² C Serial Data Input
E4	18	INR-	Right Channel Inverting Analog Input
E5	15	INL-	Left Channel Inverting Analog Input
E6	14	REF	ADC Reference Bypass
F1	24	MCLK	Master Clock
F2	22	SCLK	Serial Clock Input
F3	21	SDIO	I ² S Serial Data Input/Output
F4	19	SCL	I ² C Clock Input
F5	17	INR+	Right Channel Non-Inverting Analog Input
F6	16	INL+	Left Channel Non-Inverting Analog Input



These devices have limited built-in ESD protection. The leads should be shorted together or the device placed in conductive foam during storage or handling to prevent electrostatic damage to the MOS gates.

Absolute Maximum Ratings ⁽¹⁾ ⁽²⁾

Supply Voltage	
AV _{DD} , PV _{DD} , PLV _{DD} , IOV _{DD} ⁽¹⁾	6.0V
Supply Voltage, DV _{DD} ⁽¹⁾	2.2V
Storage Temperature	-65°C to + 150°C
Input Voltage	-0.3V to V _{DD} + 0.3V
Power Dissipation ⁽³⁾	Internally limited
ESD Susceptibility ⁽⁴⁾	2000V
ESD Susceptibility ⁽⁵⁾	150V
Junction Temperature	150°C
Thermal Resistance	
θ _{JA} (microSMD)	26°C/W
θ _{JA} (LLP)	26°C/W
θ _{JC} (LLP)	2.6°C/W

- ⁽¹⁾ “*Absolute Maximum Ratings*” indicate limits beyond which damage to the device may occur, including inoperability and degradation of device reliability and/or performance. Functional operation of the device and/or non-degradation at the *Absolute Maximum Ratings* or other conditions beyond those indicated in the *Recommended Operating Conditions* is not implied. The *Recommended Operating Conditions* indicate conditions at which the device is functional and the device should not be operated beyond such conditions. All voltages are measured with respect to the ground pin, unless otherwise specified.
- ⁽²⁾ The *Electrical Characteristics* tables list guaranteed specifications under the listed *Recommended Operating Conditions* except as otherwise modified or specified by the *Electrical Characteristics Conditions* and/or Notes. Typical specifications are estimations only and are not guaranteed.
- ⁽³⁾ The maximum power dissipation must be derated at elevated temperatures and is dictated by T_{JMAX}, θ_{JA}, and the ambient temperature, T_A. The maximum allowable power dissipation is P_{DMAX} = (T_{JMAX} - T_A) / θ_{JA} or the given in *Absolute Maximum Ratings*, whichever is lower.
- ⁽⁴⁾ Human body model, applicable std. JESD22-A114C.
- ⁽⁵⁾ Machine model, applicable std. JESD22-A115-A.

Operating Ratings

Temperature Range	
T _{MIN} ≤ T _A ≤ T _{MAX}	-40°C ≤ T _A ≤ +85°C
Supply Voltage	
AV _{DD}	2.7V ≤ AV _{DD} ≤ 5.5V

Operating Ratings (continued)

PV_{DD}	$2.7V \leq PV_{DD} \leq 5.5V$
$PLL_{V_{DD}}$	$2.7V \leq PLL_{V_{DD}} \leq 5.5V$
IOV_{DD}	$1.62V \leq IOV_{DD} \leq 5.5V$
DV_{DD}	$1.62V \leq DV_{DD} \leq 1.98V$

Electrical Characteristics $PV_{DD} = AV_{DD} = 5V$, $IOV_{DD} = PLLV_{DD} = 3.3V$, $DV_{DD} = 1.8$ ⁽¹⁾ ⁽²⁾

The following specifications apply for $A_V = 0dB$, $C_{REF} = 4.7\mu F$, $R_L = 8\Omega$, $f = 1kHz$, unless otherwise specified. Limits apply for $T_A = 25^\circ C$.

Symbol	Parameter	Conditions	LM48901			Units (Limits)	
			Min (2)	Typ (3)	Max (2)		
AV_{DD}	Analog Supply Voltage Range	(4)	2.7		5.5	V	
PV_{DD}	Amplifier Supply Voltage Range	(4)	2.7		5.5	V	
$PLLV_{DD}$	PLL Supply Voltage Range		2.7		5.5	V	
IOV_{DD}	Interface Supply Voltage Range		1.62		5.5	V	
DV_{DD}	Digital Supply Voltage Range		1.62		1.98	V	
AI_{DD}	Analog Quiescent Supply Current	LM48901RL		17.5	21	mA	
		LM48901SQ		19.2	22.3	mA	
PI_{DD}	Amplifier Quiescent Supply Current	$R_L = 8\Omega$		5.25	8.25	mA	
$PLLI_{DD}$	PLL Quiescent Supply Current	LM48901RL		1.5		mA	
DI_{DD}	Quiescent Digital Power Supply Current			5.5	6.2	mA	
I_{SD}	Shutdown Current (Analog, Amplifier and PLL Supplies)	Shutdown Enabled		1	5	μA	
DI_{STBY}	Digital Standby Current			30		μA	
DI_{SD}	Digital Shutdown Current	Shutdown Enabled		2		μA	
V_{OS}	Differential Output Offset Voltage	$V_{IN} = 0$	-17	0	17	mV	
T_{WU}	Wake-up Time	Power Up (Device Initialization)		150		ms	
		From Shutdown		30		ms	
f_{SW}	Switching Frequency	$f_S = 48kHz$		384		kHz	
P_O	Output Power/Channel	$R_L = 4\Omega$, THD+N = 10% $f = 1kHz$, 22kHz BW					
		$V_{DD} = 5V$		2.8		W	
		$V_{DD} = 3.6V$		1.4		W	
		$R_L = 4\Omega$, THD+N = 1% $f = 1kHz$, 22kHz BW					
		$V_{DD} = 5V$		2.2		W	
		$V_{DD} = 3.6V$		1.2		W	
		$R_L = 8\Omega$, THD+N = 10% $f = 1kHz$, 22kHz BW					
		$V_{DD} = 5V$		1.7		W	
		$V_{DD} = 3.6V$		825		mW	
		$R_L = 8\Omega$, THD+N = 1% $f = 1kHz$, 22kHz BW					
$V_{DD} = 5V$	1.0	1.3		W			
$V_{DD} = 3.6V$		650		mW			

- (1) The *Electrical Characteristics* tables list guaranteed specifications under the listed *Recommended Operating Conditions* except as otherwise modified or specified by the *Electrical Characteristics Conditions* and/or Notes. Typical specifications are estimations only and are not guaranteed.
- (2) R_L is a resistive load in series with two inductors to simulate an actual speaker load. For $R_L = 8\Omega$, the load is $15\mu H + 8\Omega + 15\mu H$. For $R_L = 4\Omega$, the load is $15\mu H + 4\Omega + 15\mu H$.
- (3) Datasheet min/max specification limits are guaranteed by design, test, or statistical analysis.
- (4) Maintain PV_{DD} and AV_{DD} at the same voltage potential.

Electrical Characteristics $PV_{DD} = AV_{DD} = 5V$, $IOV_{DD} = PLLV_{DD} = 3.3V$, $DV_{DD} = 1.8$ ⁽¹⁾ ⁽²⁾ (continued)

The following specifications apply for $A_V = 0dB$, $C_{REF} = 4.7\mu F$, $R_L = 8\Omega$, $f = 1kHz$, unless otherwise specified. Limits apply for $T_A = 25^\circ C$.

Symbol	Parameter	Conditions	LM48901			Units (Limits)
			Min ⁽²⁾	Typ ⁽³⁾	Max ⁽²⁾	
P_O	Output Power (Parallel Mode) ⁽⁵⁾	$R_L = 4\Omega$, THD+N = 10%, $f = 1kHz$, 22kHz BW				
		$V_{DD} = 5V$		3.2		W
		$V_{DD} = 3.6V$		1.6		W
		$R_L = 4\Omega$, THD+N = 1%, $f = 1kHz$, 22kHz BW				
		$V_{DD} = 5V$		2.5		W
		$V_{DD} = 3.6V$		1.2		W
THD+N	Total Harmonic Distortion + Noise	$P_O = 500mW$, $f = 1kHz$, $R_L = 8\Omega$		0.06		%
PSRR	Power Supply Rejection Ratio (ADC Path)	$V_{RIPPLE} = 200mV_{P-P}$ sine, Inputs AC GND, $C_{IN} = 1\mu F$				
		$f_{RIPPLE} = 217Hz$, Applied to PV_{DD}		67		dB
		$f_{RIPPLE} = 217Hz$, Applied to DV_{DD}		54		dB
		$f_{RIPPLE} = 1kHz$, Applied to PV_{DD}		66		dB
		$f_{RIPPLE} = 1kHz$, Applied to DV_{DD}		54		dB
		$f_{RIPPLE} = 10kHz$, Applied to PV_{DD}		57		dB
PSRR	Power Supply Rejection Ratio (I^2S Path)	$V_{RIPPLE} = 200mV_{P-P}$ sine, Inputs $-120dBFS$				
		$f_{RIPPLE} = 217Hz$, Applied to PV_{DD}		71		dB
		$f_{RIPPLE} = 217Hz$, Applied to DV_{DD}		58		dB
		$f_{RIPPLE} = 1kHz$, Applied to PV_{DD}		69		dB
		$f_{RIPPLE} = 1kHz$, Applied to DV_{DD}		57		dB
		$f_{RIPPLE} = 10kHz$, Applied to PV_{DD}		70		dB
CMRR	Common Mode Rejection Ratio	$V_{RIPPLE} = 1V_{P-P}$, $f_{RIPPLE} = 217Hz$, $A_V = 0dB$				
				60		dB
η	Efficiency/Channel	$V_{DD} = 5V$, $P_O = 1.1W$				
				89		%
η	Efficiency	$V_{DD} = 3.6V$, $P_O = 400mW$				
				87		%
SNR	Signal-to-Noise-Ratio	$V_{DD} = 5V$, $P_O = 1.1W$				
				87		%
SNR	Signal-to-Noise-Ratio	ADC Input, $P_O = 1W$				
				85		dB
SNR	Signal-to-Noise-Ratio	I^2S Input, $P_O = 1W$				
				87		dB
CMVR	Common Mode Input Voltage Range			5		V
ϵ_{OS}	Output Noise	Inputs AC GND, A-weighted, $A_V = 0dB$				
				130		μV
ϵ_{OS}	Output Noise	I^2S Input				
				72		μV
X_{TALK}	Crosstalk			75		dB

(5) Only OUT2 and OUT3 can be configured in Parallel Mode.

I²C Interface Characteristics ⁽¹⁾ ⁽²⁾

The following specifications apply for R_{PU} = 1kΩ to IOV_{DD}, unless otherwise specified. Limits apply for T_A = 25°C.

Symbol	Parameter	Conditions	LM48901			Units
			Min (3)	Typ (4)	Max (3)	
VIH	Logic Input High Threshold	SDA, SCL	0.7*IOV _{DD}			V
VIL	Logic Input Low Threshold	SDA, SCL		300		mV
VOL	Logic Output Low Threshold	SDA, ISDA = 3.6mA			0.35	V
IOH	Logic Output High Current	SDA, SCL			2	uA
	SCL Frequency				400	kHz
1	Hold Time (repeated START Condition)		0.6			μs
2	Clock Low Time		1.3			μs
3	Clock High Time		600			ns
4	Setup Time for Repeated START condition		600			ns
5	Data Hold Time	Output	300		900	ns
6	Data Setup Time		100			ns
7	SDA Rise Time				300	ns
8	SDA Fall Time				300	ns
9	Setup Time for STOP Condition		600			ns
10	Bus Free Time Between STOP and START Condition		1.3			μs

- (1) “*Absolute Maximum Ratings*” indicate limits beyond which damage to the device may occur, including inoperability and degradation of device reliability and/or performance. Functional operation of the device and/or non-degradation at the *Absolute Maximum Ratings* or other conditions beyond those indicated in the *Recommended Operating Conditions* is not implied. The *Recommended Operating Conditions* indicate conditions at which the device is functional and the device should not be operated beyond such conditions. All voltages are measured with respect to the ground pin, unless otherwise specified.
- (2) The *Electrical Characteristics* tables list guaranteed specifications under the listed *Recommended Operating Conditions* except as otherwise modified or specified by the *Electrical Characteristics Conditions* and/or Notes. Typical specifications are estimations only and are not guaranteed.
- (3) Datasheet min/max specification limits are guaranteed by design, test, or statistical analysis.
- (4) Typical values represent most likely parametric norms at T_A = +25°C, and at the *Recommended Operation Conditions* at the time of product characterization and are not guaranteed.

I²S Timing Characteristics ⁽¹⁾ ⁽²⁾

The following specifications apply for $DV_{DD} = 1.8V$, unless otherwise specified. Limits apply for $T_A = 25^\circ C$.

Symbol	Parameter	Conditions	LM48901			Units (Limits)
			Min (3)	Typ (4)	Max (3)	
t_{MCLKL}	MCLK Pulse Width Low		16			ns
t_{MCLKH}	MCLK Pulse Width High		16			ns
t_{MCLKY}	MCLK Period		27			ns
t_{BCLKR}	SCLK rise time				3	ns
t_{BCLKCF}	SCLK fall time				3	ns
t_{BCLKDS}	SCLK Duty Cycle			50		%
T_{DL}	LRC Propagation Delay from SCLK falling edge				10	ns
T_{DST}	DATA Setup Time to SCLK Rising Edge		10			ns
T_{DHT}	DATA Hold Time from SCLK Rising Edge		10			ns

- (1) The *Electrical Characteristics* tables list guaranteed specifications under the listed *Recommended Operating Conditions* except as otherwise modified or specified by the *Electrical Characteristics Conditions* and/or Notes. Typical specifications are estimations only and are not guaranteed.
- (2) R_L is a resistive load in series with two inductors to simulate an actual speaker load. For $R_L = 8\Omega$, the load is $15\mu H + 8\Omega + 15\mu H$. For $R_L = 4\Omega$, the load is $15\mu H + 4\Omega + 15\mu H$.
- (3) Datasheet min/max specification limits are guaranteed by design, test, or statistical analysis.
- (4) Typical values represent most likely parametric norms at $T_A = +25^\circ C$, and at the *Recommended Operation Conditions* at the time of product characterization and are not guaranteed.

Typical Performance Characteristics

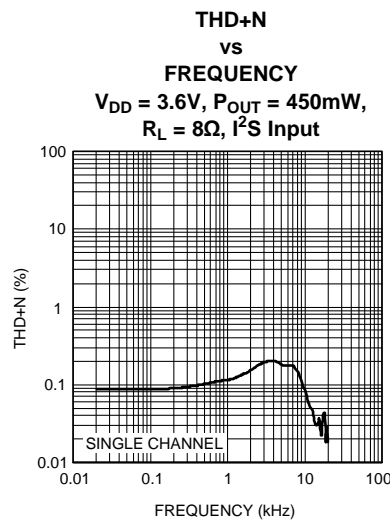
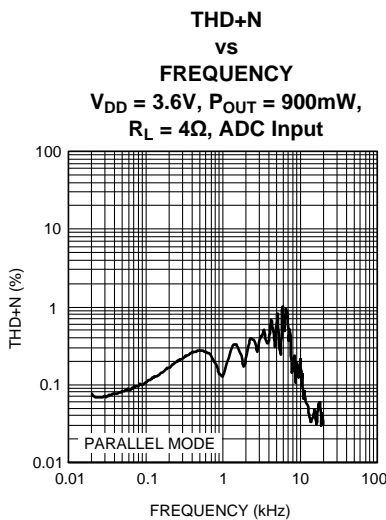
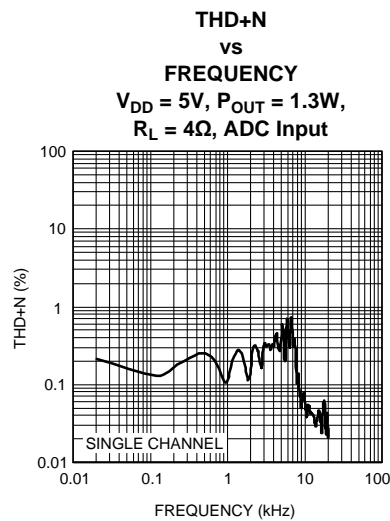
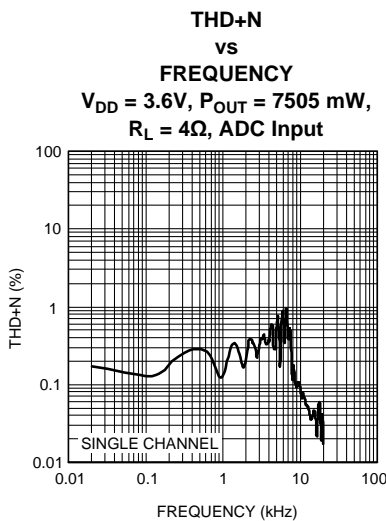
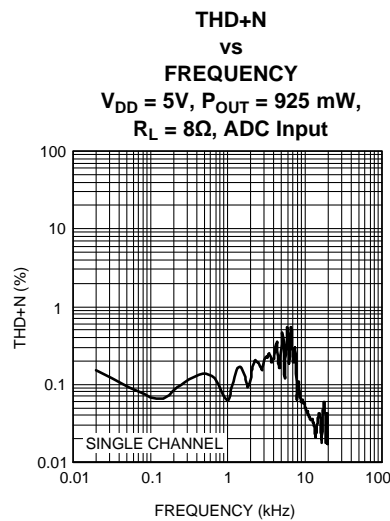
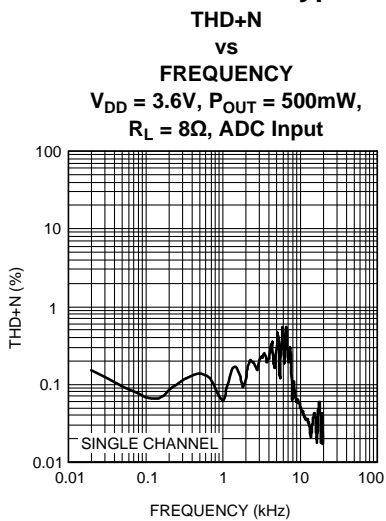

Typical Performance Characteristics (continued)

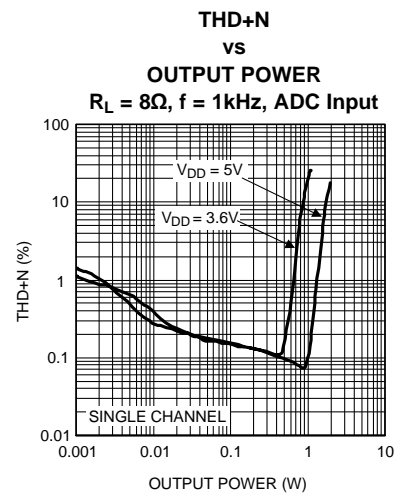
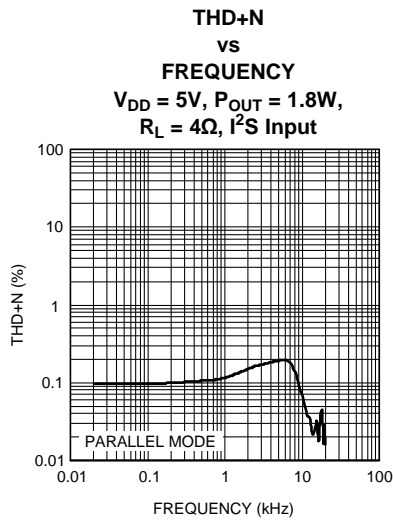
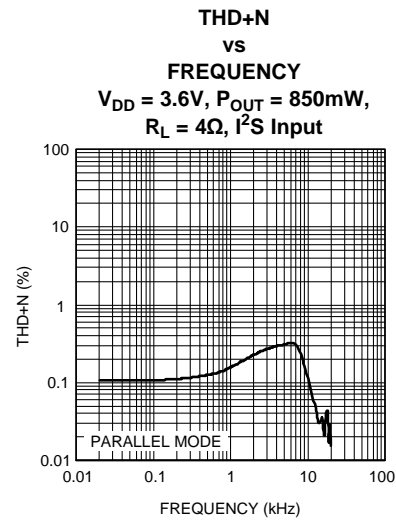
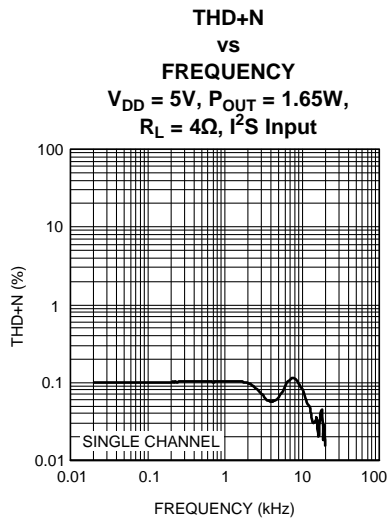
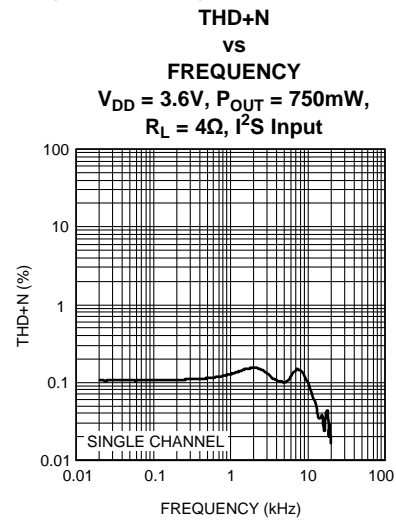
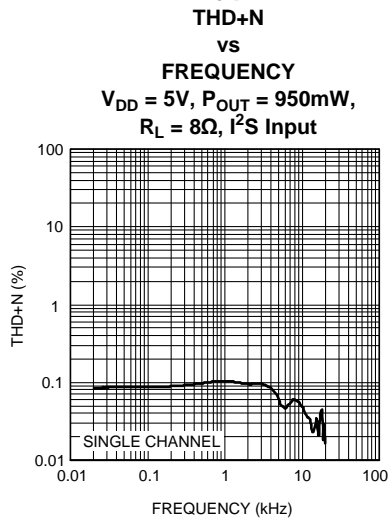

Typical Performance Characteristics (continued)

THD+N vs OUTPUT POWER
 $R_L = 4\Omega, f = 1\text{kHz}, \text{ADC Input, Single channel}$

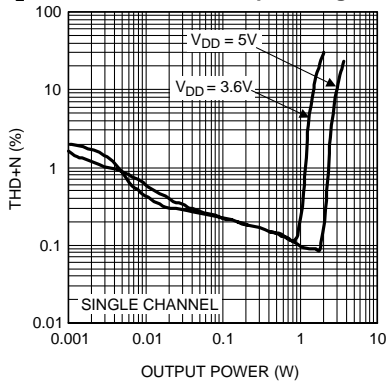

THD+N vs OUTPUT POWER
 $R_L = 8\Omega, f = 1\text{kHz}, \text{ADC Input}$

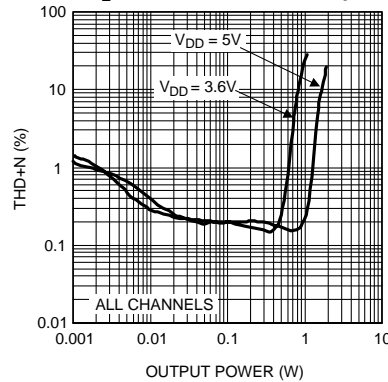

THD+N vs OUTPUT POWER
 $R_L = 4\Omega, f = 1\text{kHz}, \text{ADC Input, All channels}$

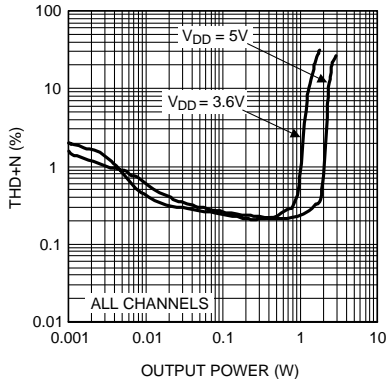

THD+N vs OUTPUT POWER
 $R_L = 4\Omega, f = 1\text{kHz}, \text{ADC Input, Parallel mode}$

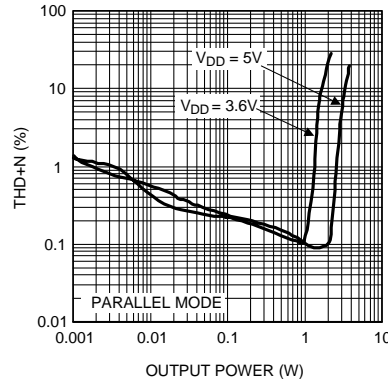

THD+N vs OUTPUT POWER
 $R_L = 8\Omega, f = 1\text{kHz}, \text{I}^2\text{S Input, Single mode}$

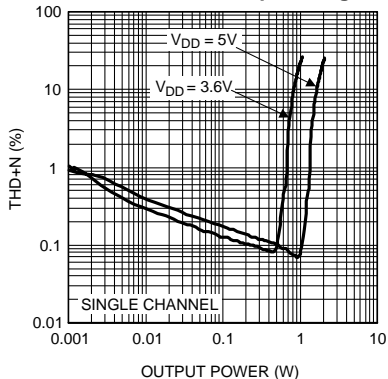

THD+N vs OUTPUT POWER
 $R_L = 4\Omega, f = 1\text{kHz}, \text{I}^2\text{S Input, Single channel}$

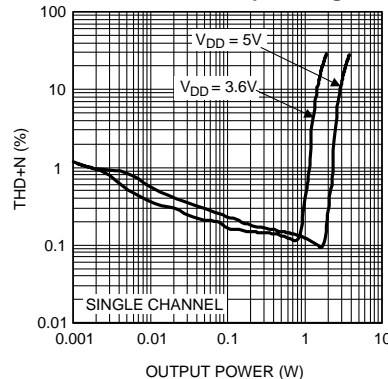

Typical Performance Characteristics (continued)

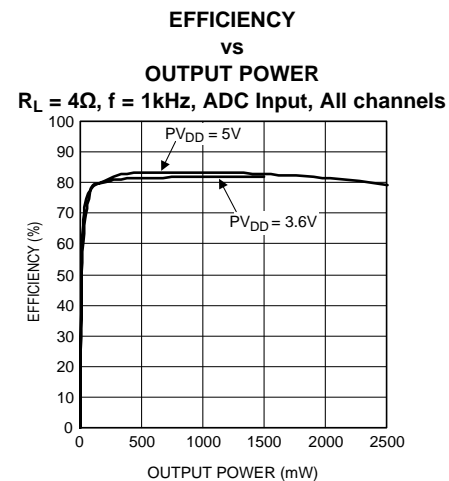
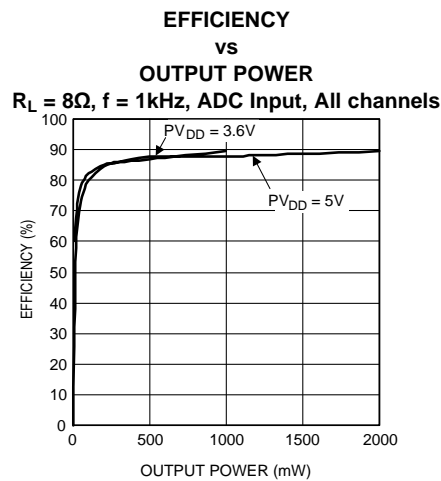
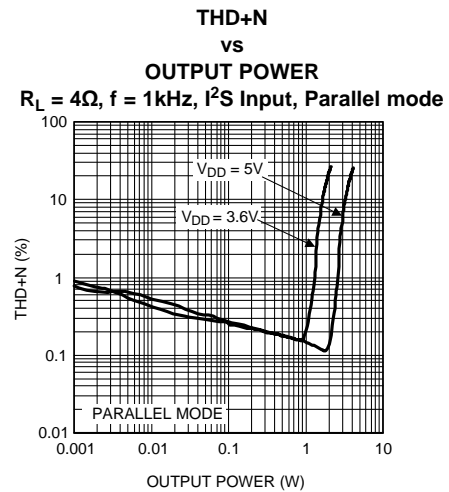
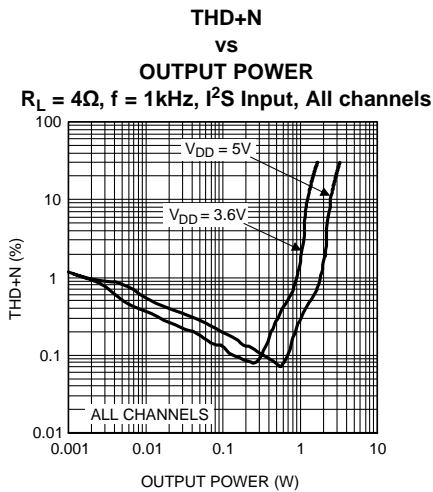
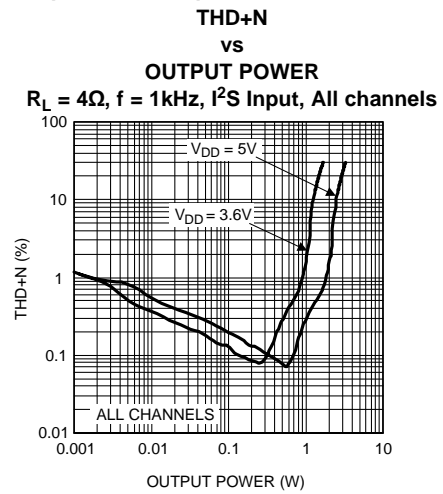
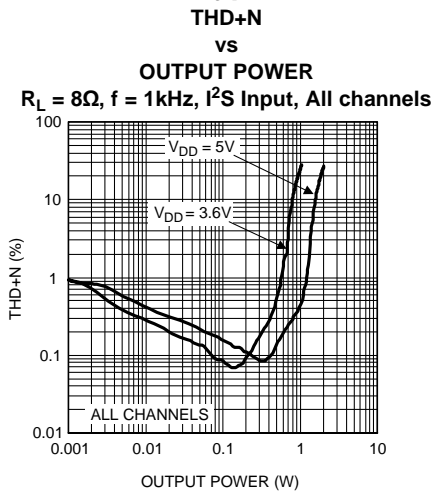

Typical Performance Characteristics (continued)

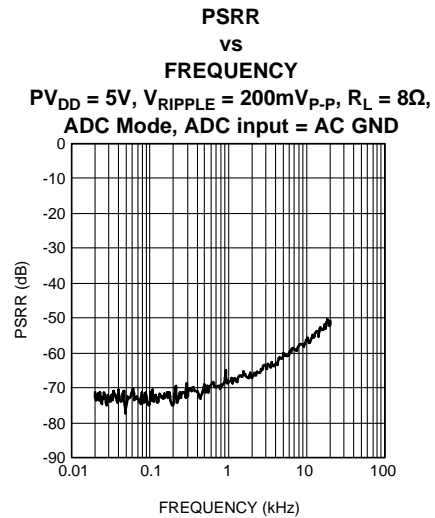
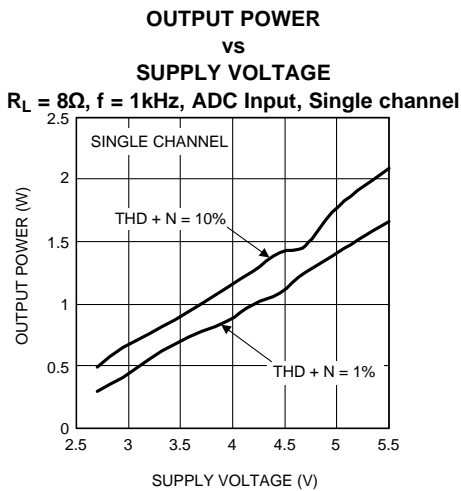
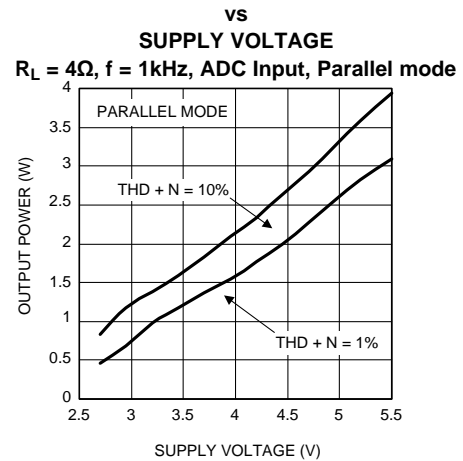
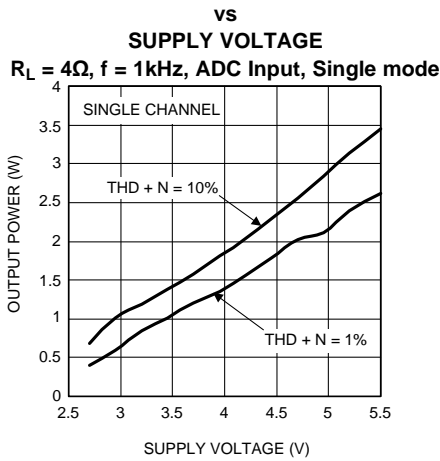
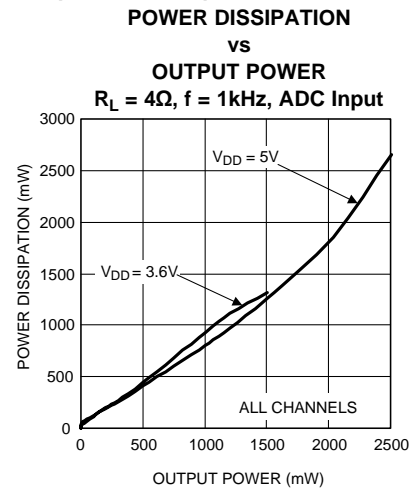
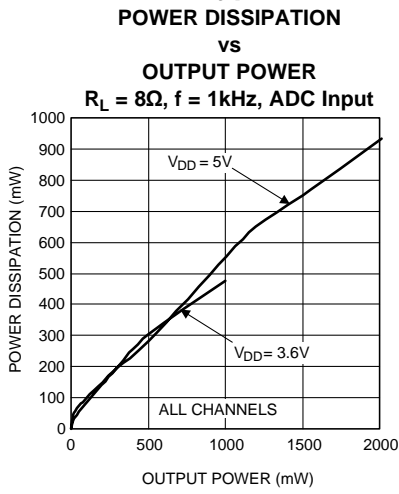

Typical Performance Characteristics (continued)

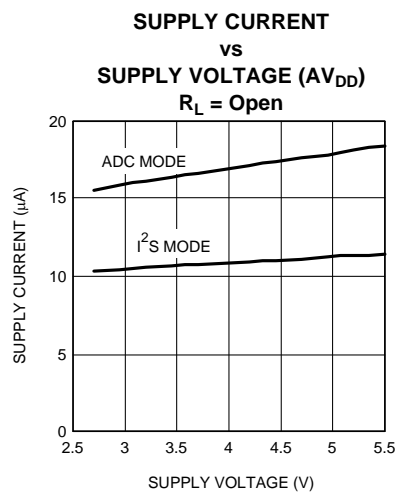
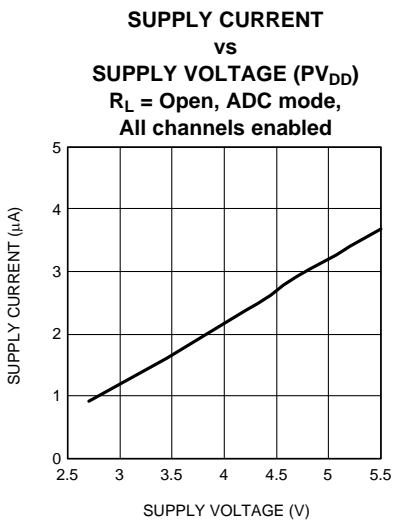
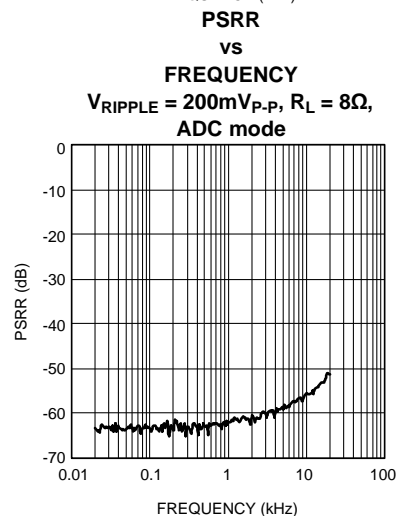
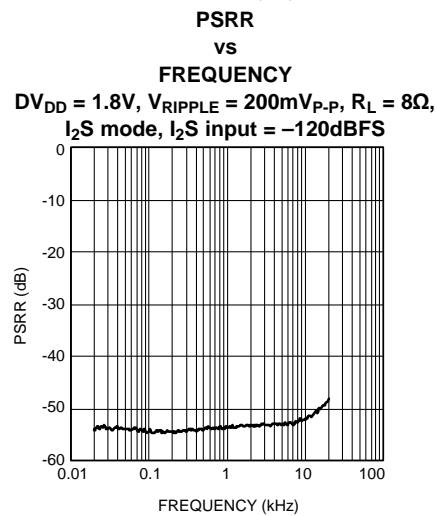
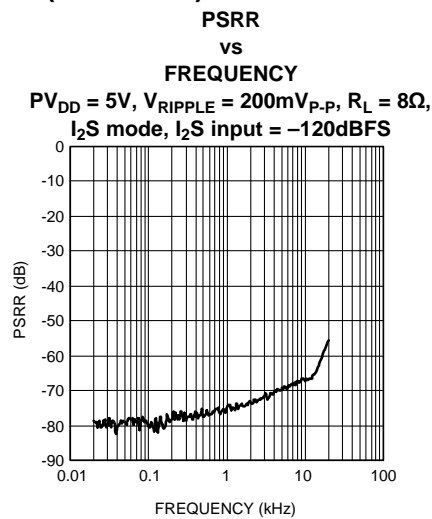
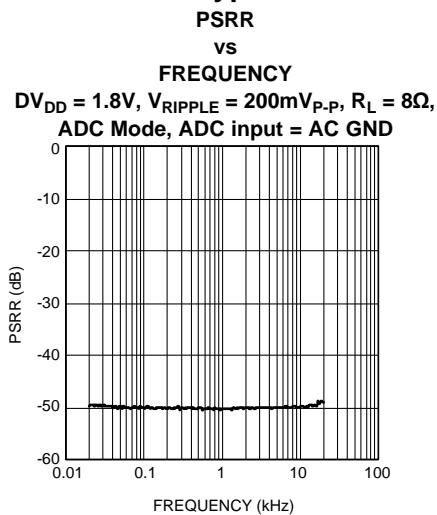

Typical Performance Characteristics (continued)

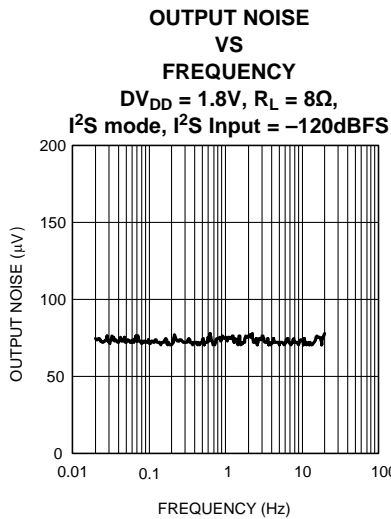
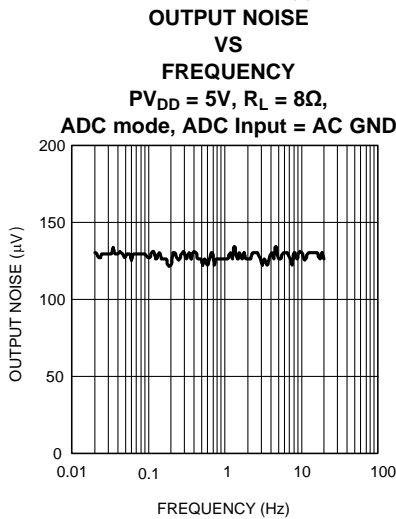
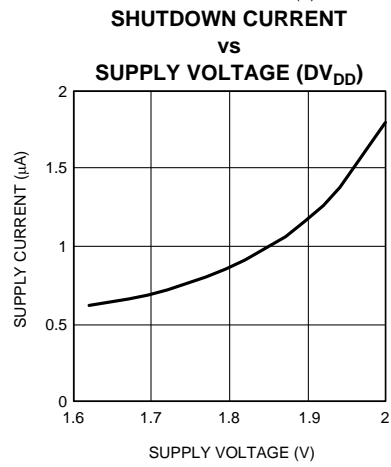
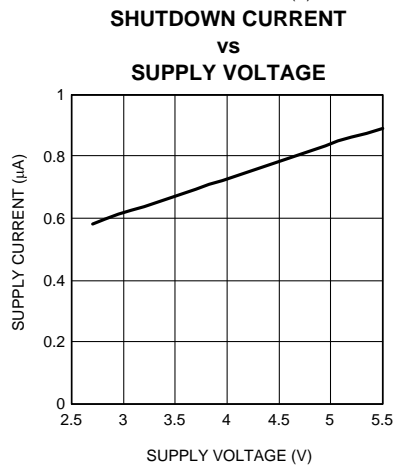
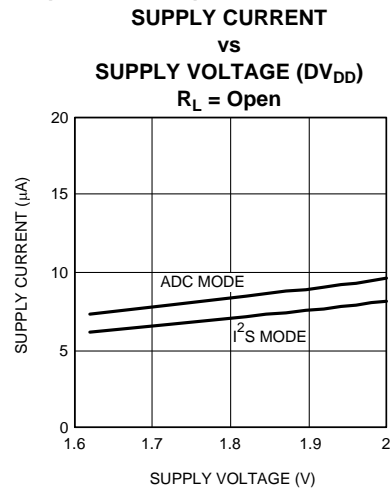
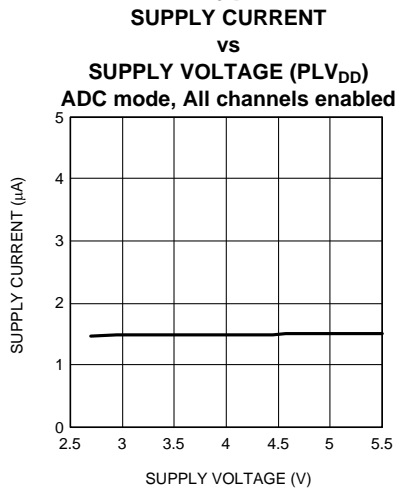

Application Information

I²C COMPATIBLE INTERFACE

The LM48901 is controlled through an I²C compatible serial interface that consists of a serial data line (SDA) and a serial clock (SCL). The clock and data lines are bi-directional (open drain). The LM48901 can communicate at clock rates up to 400kHz. Figure 6 shows the I²C interface timing diagram. Data on the SDA line must be stable during the HIGH period of SCL. The LM48901 is a transmit/receive device, and can act as the I²C master, generating the SCL signal. Each transmission sequence is framed by a START condition and a STOP condition Figure 7.

Due to the number of data registers, the LM48901 employs a page mode scheme. Each data write consists of 7, 8 bit data bytes, device address (1 byte), 16 bit register address (2 bytes), and 32 bit register data (4 bytes). Each byte is followed by an acknowledge pulse Figure 8. Single byte read and write commands are ignored. The LM48901 device address is 0110000X.

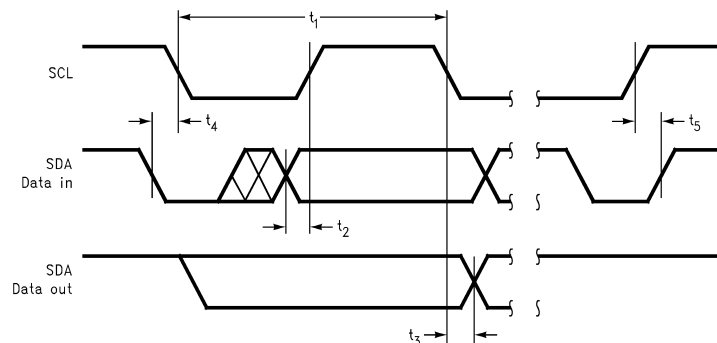

Figure 6. I²C Timing Diagram

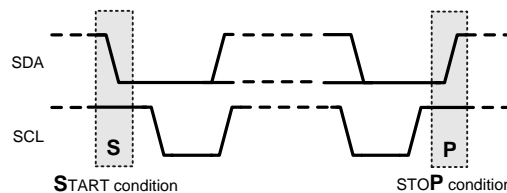

Figure 7. Start and Stop Diagram

WRITE SEQUENCE

The example write sequence is shown in Figure 8. The START signal, the transition of SDA from HIGH to LOW while SDA is HIGH, is generated, altering all devices on the bus that a device address is being written to the bus.

The 7-bit device address is written to the bus, most significant bit (MSB) first, followed by the R/W bit ($R/\bar{W} = 0$ indicating the master is writing to the LM48901). The data is latched in on the rising edge of the clock. Each address bit must be stable while SDA is HIGH. After the R/W bit is transmitted, the master device releases SDA, during which time, an acknowledge clock pulse is generated by the slave device. If the LM48901 receives the correct address, the device pulls the SDA line low, generating an acknowledge bit (ACK).

Once the master device registers the ACK bit, the first 8-bit register address word is sent, MSB first [15:8]. Each data bit should be stable while SCL is HIGH. After the first 8-bit register address is sent, the LM48901 sends another ACK bit. Upon receipt of acknowledge, the second 8-bit register address word is sent [7:0], followed by another ACK bit. The register data is sent, 8-bits at a time, MSB first in the following order [7:0], [15:8], [23:16], [31:24]. Each 8-bit word is followed by an ACK, upon receipt of which the successive 8-bit word is sent. Following the acknowledgement of the last register data word [31:24], the master issues a STOP bit, allowing SDA to go high while SDA is high.

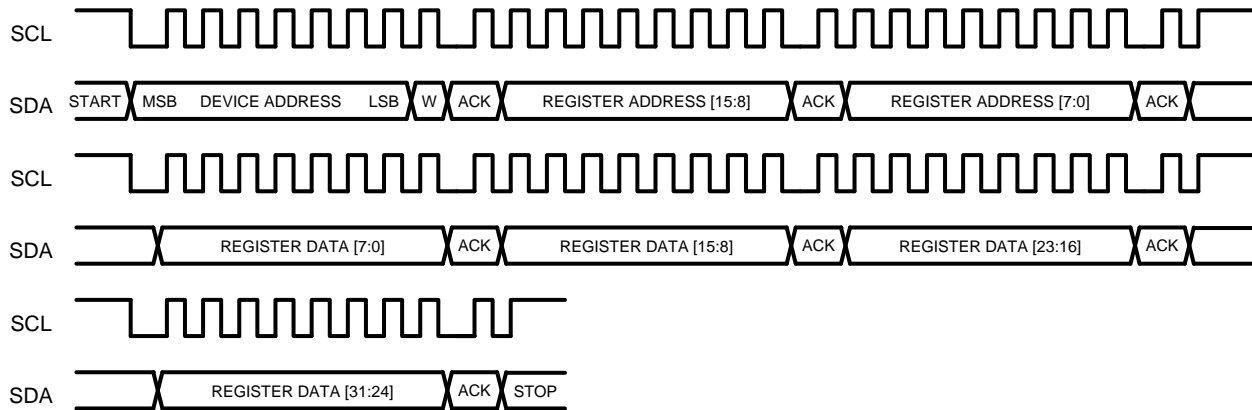

Figure 8. Example I²C Write Sequence

READ SEQUENCE

The example read sequence is shown in [Figure 9](#). The START signal, the transition of SDA from HIGH to LOW while SDA is HIGH, is generated, altering all devices on the bus that a device address is being written to the bus.

The 7-bit device address is written to the bus, followed by the $R/\bar{W} = 0$. After the R/\bar{W} bit is transmitted, the master device releases SDA, during which time, an acknowledge clock pulse is generated by the slave device. If the LM48901 receives the correct address, the device pulls the SDA line low, generating an acknowledge bit (ACK). Once the master device registers the ACK bit, the first 8-bit register address word is sent, MSB first [15:8], followed by an ACK from the LM48901. Upon receipt of the acknowledge, the second 8-bit register address word is sent [7:0], followed by another ACK bit. Following the acknowledgement of the last register address, the master initiates a REPEATED START, followed by the 7-bit device address, followed by $R/\bar{W} = 1$ ($R/\bar{W} = 1$ indicating the master wants to read data from the LM48901). The LM48901 sends an ACK, followed by the selected register data. The register data is sent, 8-bits at a time, MSB first in the following order [7:0], [15:8], [23:16], [31:24]. Each 8-bit word is followed by an ACK, upon receipt of which the successive 8-bit word is sent. Following the acknowledgement of the last register data word [31:24], the master issues a STOP bit, allowing SDA to go high while SDA is high.

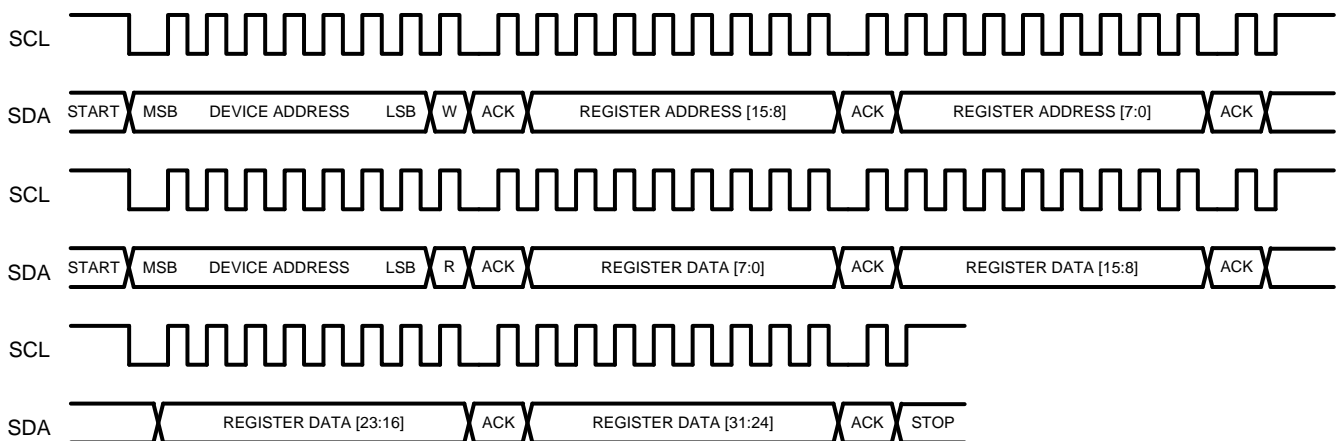

Figure 9. Example I²C Read Sequence

I²S DATA FORMAT

The LM48901 supports three I²S formats: Normal Mode [Figure 10](#), Left Justified Mode [Figure 11](#), and Right Justified Mode [Figure 12](#). In Normal Mode, the audio data is transmitted MSB first, with the unused bits following the LSB. In Left Justified Mode, the audio data format is similar to the Normal Mode, without the delay between the LSB and the change in I²S_WS. In Right Justified Mode, the audio data MSB is transmitted after a delay of a preset number of bits.

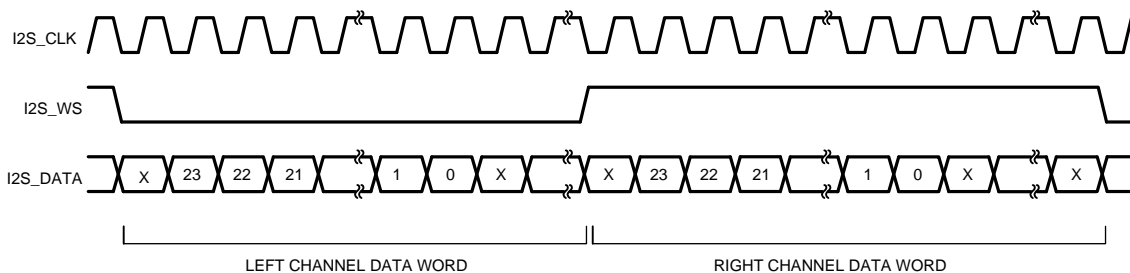

Figure 10. I²S Normal Input Format

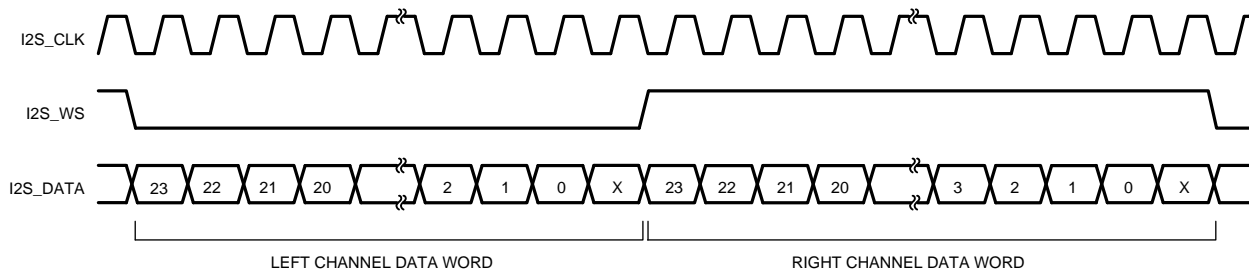

Figure 11. I²S Left Justified Input Format

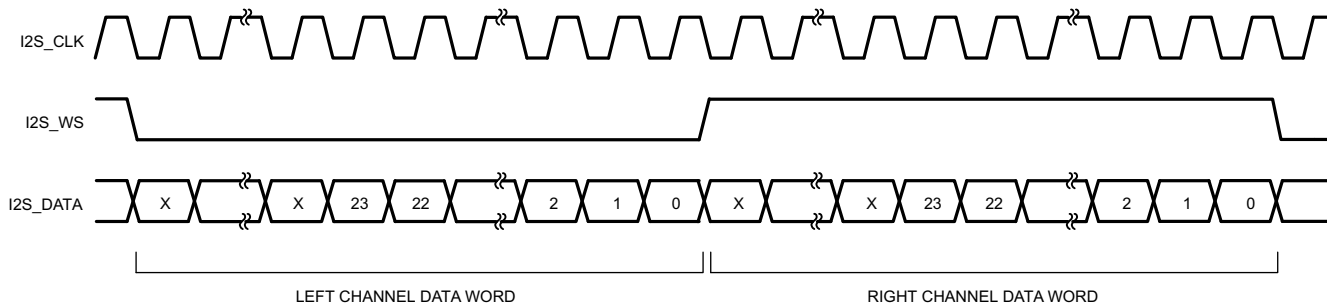

Figure 12. I²S Right Justified Input Format

MEMORY ORGANIZATION

The LM48901 memory is organized into three main regions: a 32-bit wide Coefficient Space that holds the spatial coefficients, a 32-bit wide Register Space that holds the device configuration settings, and a 48-bit wide Audio Sample Space that holds the current audio data sampled from either the ADCs or the I2S interface, organized as shown in Figure 13.

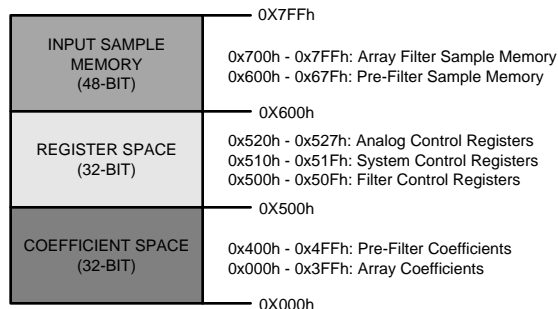

Figure 13. LM48901 Memory Organization

COEFFICIENT MEMORY

The device must be in Debug mode in order to write to the Coefficient memory. Set Bit 7 (DBG_ENABLE) in Filter Debug Register 1 (0x504h) = 1 to enable Debug mode. The Coefficient Memory Space is organized as follows.

Table 3. Coefficient Memory Space

REGISTER ADDRESS	REGISTER CONTENTS	
	(31:16)	(15:0)
0x000h - 0x0FFh	256x16 bit Array Taps (Right Input to OUT4)	256x16 bit Array Taps (Left Input to OUT4)
	256x16 bit Array Taps (Right Input to OUT3)	256x16 bit Array Taps (Left Input to OUT3)
0x200h - 0x2FFh	256x16 bit Array Taps (Right Input to OUT2)	256x16 bit Array Taps (Left Input to OUT2)
	256x16 bit Array Taps (Right Input to OUT1)	256x16 bit Array Taps (Left Input to OUT1)
0x400h - 0x47Eh (EVEN)	C2 128x16 bit Prefilter Taps (Right to Right)	C0 128x16 bit Prefilter FIR Taps (Left to Left)
	C3 128x16 bit Prefilter Taps (Right to Left)	C1 128x16 bit Prefilter FIR Taps (Left to Right)

CONTROL REGISTERS

Table 4. Register Map

Register Name	Register Address	Default Value	7	6	5	4	3	2	1	0
FILTER CONTROL	0x500h [7:0]	0xFFh	ARRAY_TAP							
	0x500h [15:8]	0xFFh	UNUSED	PRE_TAP						
	0x500h [23:16]	0xE4h	CH4_SEL		CH3_SEL		CH2_SEL		CH1_SEL	
	0x500h [31:24]	0x31h	ARRAY_ ENABLE	PRE_ ENABLE	ARRAY_ BYPASS	PRE_ BYPASS	UNUSED			
FILTER COMP1	0x501h [7:0]	0x00h	G1_GAIN			COMP_TH				
	0x501h [15:8]	0x00h	UNUSED	POST_GAIN		UNUSED	COMP_RATIO			
	0x501h [23:16]	0x00h	ARRAY_COMP_SELECT							
	0x501h [31:24]	0x00h	UNUSED							
FILTER COMP2	0x502h [7:0]	0x00h	G1_GAIN			COMP_TH				
	0x502h [15:8]	0x00h	UNUSED	POST_GAIN		UNUSED	COMP_RATIO			
	0x502h [23:16]	0x00h	G1_GAIN			COMP_TH				
	0x502h [31:24]	0x00h	UNUSED	POST_GAIN		UNUSED	COMP_RATIO			
FILTER DEBUG0	0x503h [7:0]	0xFFh	DBG_DATA [7:0]							
	0x503h [15:8]	0xFFh	DBG_DATA [15:8]							
	0x503h [23:16]	0xFFh	DBG_DATA [23:16]							
	0x503h [31:24]	0xFFh	DBG_ STEP	UNUSED						
FILTER DEBUG1	0x504h [7:0]	0xFFh	DBG_ ENABLE	STEP_ ENABLE	UNUSED	FILTER_ SELECT	ACC_ADDR			
	0x504h [15:8]	0xFFh	UNUSED							
	0x504h [23:16]	0xFFh	UNUSED							
	0x504h [31:24]	0xFFh	UNUSED							

Table 4. Register Map (continued)

Register Name	Register Address	Default Value	7	6	5	4	3	2	1	0	
FILTER STATS	0x505h [7:0]	0x00h	COUNT1_MODE				CH_SEL				
	0x505h [15:8]	0x80h	CLEAR	UNUSED				COUNT2_MODE			
	0x505h [23:16]	0x00h	COUNT1_MODE				CH_SEL				
	0x505h [31:24]	0x80h	CLEAR	UNUSED				COUNT2_MODE			
FILTER TAP (READ-ONLY)	0x508h [7:0]	0x7Fh	TAP_LENGTH								
	0x508h [15:8]	0x00h	UNUSED								
	0x508h [23:16]	0x00h	UNUSED								
	0x508h [31:24]	0x00h	UNUSED								
ACCUML DEBUG (READ-ONLY)	0x509h [7:0]	0x00h	DBG_ACCL [7:0]								
	0x509h [15:8]	0x00h	DBG_ACCL [15:8]								
	0x509h [23:16]	0x00h	DBG_ACCL [23:16]								
	0x509h [31:24]	0x00h	DBG_ACCL [31:24]								
ACCUMH DEBUG (READ-ONLY)	0x50Ah [7:0]	0x00h	DBG_ACCH								
	0x50Ah [15:8]	0x00h	BDG_ACCH								
	0x50Ah [23:16]	0x00h	UNUSED								
	0x50Ah [31:24]	0x00h	UNUSED								
DBG SAT (READ-ONLY)	0x50Bh [7:0]	0x00h	DBG_SAT [7:0]								
	0x50Bh [15:8]	0x00h	DBG_SAT [15:8]								
	0x50Bh [23:16]	0x00h	DBG_SAT [23:16]								
	0x50Bh [31:24]	0x00h	UNUSED								
STAT PCNT1 (READ-ONLY)	0x50Ch [7:0]	0x00h	COUNT [7:0]								
	0x50Ch [15:8]	0x00h	COUNT [15:8]								
	0x50Ch [23:16]	0x00h	COUNT [23:16]								
	0x50Ch [31:24]	0x00h	OVF	COUNT [30:24]							
STAT PCNT2 (READ-ONLY)	0x50Dh [7:0]	0x00h	COUNT [7:0]								
	0x50Dh [15:8]	0x00h	COUNT [15:8]								
	0x50Dh [23:16]	0x00h	COUNT [23:16]								
	0x50Dh [31:24]	0x00h	OVF	COUNT [30:24]							
STAT ACNT1 (READ-ONLY)	0x50Eh [7:0]	0x00h	COUNT [7:0]								
	0x50Eh [15:8]	0x00h	COUNT [15:8]								
	0x50Eh [23:16]	0x00h	COUNT [23:16]								
	0x50Eh [31:24]	0x00h	OVF	COUNT [30:24]							
STAT ACNT2 (READ-ONLY)	0x50Fh [7:0]	0x00h	COUNT [7:0]								
	0x50Fh [15:8]	0x00h	COUNT [15:8]								
	0x50Fh [23:16]	0x00h	COUNT [23:16]								
	0x50Fh [31:24]	0x00h	OVF	COUNT [30:24]							
SYS CONFIG	0x530h [7:0]	0x30h	CONFIG	DEVICE_ID							
			CLK								
	0x530h [15:8]	0x00h	ENABLE	ALT_DEVICE_ID							
			ALTID_								
0x530h [23:16]	0x8Ch	CL_	UNUSED		CL_PAGE			CL_W	CL_REQ		
		ENABLE									
0x530h [31:24]	0x00h	UNUSED							MBIST1_	MBIST0_	
									ENABLE	ENABLE	

Table 4. Register Map (continued)

Register Name	Register Address	Default Value	7	6	5	4	3	2	1	0	
CL REG0	0x531h [7:0]	0x00h	TRANS_LENGTH [7:0]								
	0x531h [15:8]	0x10h	TRANS_LENGTH [15:8]								
	0x531h [23:16]	0x00h	REG_START_ADDR [7:0]								
	0x531h [31:24]	0x00h	REG_START_ADDR [16:8]								
CL REG1	0x532h [7:0]	0x00h	E2_START_ADDR [7:0]								
	0x532h [15:8]	0x00h	E2_START_ADDR [15:8]								
	0x532h [23:16]	0x00h	UNUSED								
	0x532h [31:24]	0x00h	UNUSED								
E2_OFFSET	0x533h [7:0]	0x00h	UNUSED		E2_OFFSET						
	0x533h [15:8]	0x00h	UNUSED								
	0x533h [23:16]	0x00h	UNUSED								
	0x533h [31:24]	0x00h	UNUSED								
I ² C_EnXT	0x534h [7:0]	0x00h	I ² C_EnXT	UNUSED	E2NXT_OFFSET						
	0x534h [15:8]	0x00h	UNUSED								
	0x534h [23:16]	0x00h	UNUSED								
	0x534h [31:24]	0x00h	UNUSED								
MBIST STAT (READ-ONLY)	0x538h [7:0]	0x7Fh	UNUSED		MBIST_EN		MBIST_GO		MBIST_DONE		
	0x538h [15:8]	0x80h	UNUSED								
	0x538h [23:16]	0x00h	UNUSED								
	0x538h [31:24]	0x80h	UNUSED								
DELAY	0x520h [7:0]	0x06h	POWER_UP_DELAY [7:0]								
	0x520h [15:8]	0x00h	POWER_UP_DELAY [15:8]								
	0x520h [23:16]	0x20h	DEGLITCH_DELAY								
	0x520h [31:24]	0x09h	STATE_DELAY								
ENABLE & CLOCKS	0x521h [7:0]	0x00h	UNUSED				VREF_DELAY		PULSE	FORCE	ENABLE
	0x521h [15:8]	0x00h	UNUSED	QSA_CLK_STOP	HIFI	PCM_CLK_SEL	I2S_CLK	MCLK_RATE			
	0x521h [23:16]	0x00h	UNUSED							ADC_SYNC	
	0x521h [31:24]	0x00h	UNUSED								
DIGITAL MIXER	0x522h [7:0]	0x33h	ZERO_CROSS	MUTE	ADC_LVL						
	0x522h [15:8]	0x33h	UNUSED				I ² S_LVL				
	0x522h [23:16]	0x00h	I ² SB_ON	I ² SA_ON	I ² SB_TX_SEL		I ² SA_TX_SEL		ADC_DSP	I ² S_DSP	
	0x522h [31:24]	0x00h	OUT4_SEL		OUT3_SEL		OUT2_SEL		OUT1_SEL		
ANALOG	0x523h [7:0]	0x00h	BYPASS_MOD	AUTO_SD	ADC_TRIM	ZERO_DIG	ZERO_ANA	PARALLEL		ANA_LVL	
	0x523h [15:8]	0x00h	UNUSED			SE_MOD	PMC_TEST	TSD_DIS	SCKT_DIS	TST_SHT	
	0x523h [23:16]	0x00h	UNUSED								
	0x523h [31:24]	0x00h	UNUSED								

Table 4. Register Map (continued)

Register Name	Register Address	Default Value	7	6	5	4	3	2	1	0	
I ² S PORT	0x524h [7:0]	0x01h	SYNC_ MODE	STEREO_S YNC_ PHASE	CLOCK_ PHASE	SYNC_ _MS	CLK_MS	TX_ ENABLE	RX_ ENABLE	STEREO	
	0x524h [15:8]	0x00h	UNUSED			HALF_CYCLE_DIVIDER					
	0x524h [23:14]	0x00h	UNUSED				SYNTH_ DENOM	SYNTH_NUM			
	0x524h [31:24]	0x00h	UNUSED			MONO_SYNC_WIDTH			SYNC_RATE		
	0x525h [7:0]	0x00h	TX_BIT		TX_WIDTH			RX_WIDTH			
	0x525h [15:8]	0x02h	RX_ A/μLAW	RX_ COMPAND	RX_MSB_POSITION					RX_ _MODE	
	0x525h [23:16]	0x02h	TX_ A/μLAW	TX_ COMPAND	TX_MSB_POSITION					TX_ _MODE	
	0x525h [31:24]	0x00h	UNUSED								
ADC TRIM CO-EF FICIENT	0x526h [7:0]	0x00h	ADC_COMP_COEFF_C0 [7:0]								
	0x526h [15:8]	0x00h	ADC_COMP_COEFF_C0 [15:8]								
	0x526h [23:14]	0x00h	ADC_COMP_COEFF_C1 [7:0]								
	0x526h [31:24]	0x00h	ADC_COMP_COEFF_C1 [15:8]								
	0x527h [7:0]	0x00h	ADC_COMP_COEFF_C2 [7:0]								
	0x527h [15:8]	0x00h	ADC_COMP_COEFF_C2 [15:8]								
READBACK (READ- ONLY)	0x528h [7:0]	0x00h	UNUSED		I2SL_ _LVL CLIP	I2SR_ _LVL CLIP	ADCL_ _LVL CLIP	ADCR_ _LVL CLIP	ADCL_ CLIP	ADCR_ CLIP	
	0x528h [15:8]	0x00h	UNUSED			THERMAL	SHORT4	SHORT3	SHORT2	SHORT1	
	0x528h [23:14]	0x00h	SPARE								
	0x528h [31:24]	0x00h	UNUSED								
READBACK (READ- ONLY)	0x529h [7:0]	0x00h	UNUSED				CE_STATE				
	0x529h [15:8]	0x00h	SPARE								
	0x529h [23:14]	0x00h	UNUSED								
	0x529h [31:24]	0x00h	UNUSED								

FILTER CONTROL REGISTER (0x500h)

Configures the LM48901 Array and Pre-Array filters (Spatial Engine). The Filter Control Register sets the length of the Array and Pre-Array filter taps, and selects the filter channel source for each audio output. Set PRE_BYPASS and ARRAY_BYPASS to 1 to bypass the Spatial Engine, disabling the spatial effect without modifying the coefficients. Set PRE_ENABLE and ARRAY_ENABLE to 1 to enable the Spatial Engine. Set PRE_ENABLE and ARRAY_ENABLE to 0 to disable the spatial engine. Disabling the Spatial Engine does not affect the register contents. Disable the Spatial Engine during coefficient programming.

Table 5. Filter Control Register

BIT	NAME	VALUE	DESCRIPTION
7:0	ARRAY_TAP		Array Filter Tap Length
14:8	PRE_TAP		Pre-filter Tap Length. Pre-filter tap length should be less than or equal to the Array filter tap length
15	UNUSED		

Table 5. Filter Control Register (continued)

BIT	NAME	VALUE	DESCRIPTION
17:16	CH1_SEL		Channel 1 Output Routing Selection
		00	Array Filter Channel 0 Output Select
		01	Array Filter Channel 1 Output Select
		10	Array Filter Channel 2 Output Select
		11	Array Filter Channel 3 Output Select
19:18	CH2_SEL		Channel 2 Output Routing Selection
		00	Array Filter Channel 0 Output Select
		01	Array Filter Channel 1 Output Select
		10	Array Filter Channel 2 Output Select
		11	Array Filter Channel 3 Output Select
21:20	CH3_SEL		Channel 3 Output Routing Selection
		00	Array Filter Channel 0 Output Select
		01	Array Filter Channel 1 Output Select
		10	Array Filter Channel 2 Output Select
		11	Array Filter Channel 3 Output Select
23:22	CH4_SEL		Channel 4 Output Routing Selection
		00	Array Filter Channel 0 Output Select
		01	Array Filter Channel 1 Output Select
		10	Array Filter Channel 2 Output Select
		11	Array Filter Channel 3 Output Select
27:24	UNUSED		
28	PRE_BYPASS	0	Pre-Array filter not bypassed
		1	Pre-Array filter bypassed
29	ARRAY_BYPASS	0	Array filter not bypassed
		1	Array filter bypassed
30	PRE_ENABLE	0	Pre-Array filter disabled. Disable the Pre-Array Filter during filter and coefficient programming. Disabling the Pre-Array Filter does not affect the device memory contents.
		1	Pre-Array filter enabled
31	ARRAY_ENABLE	0	Array filter disabled. Disable the Array Filter during filter and coefficient programming. Disabling the Array Filter does not affect the device memory contents.
		1	Array filter enabled

COMPRESSOR CONTROL REGISTER 1 (FILTER COMP1) (0x501h)**Table 6. Compressor Control Register**

BIT	NAME	VALUE	DESCRIPTION
4:0	COMP_TH		Pre-Filter Compressor Threshold
		00000	0
		00001	0.3125
		00010	0.0625
		-	-
		10000	0.5
		-	-
		11000	0.75
		-	-
		11111	0.96875

Table 6. Compressor Control Register (continued)

BIT	NAME	VALUE	DESCRIPTION
7:5	G1_GAIN		Pre-Compression Gain (V/V)
		000	2
		001	4
		010	8
		011	16
		100	32
		101	64
		110	128
		111	256
10:8	COMP_RATIO		Compression Ratio
		000	1:1
		001	2:1
		010	2.66:1
		011	4:1
		100	5.33:1
		101	8:1
		110	10.66:1
		111	16:1
11	UNUSED		
14:12	POST_GAIN		Post Compression Gain (V/V)
		000	1
		001	1.25
		010	1.5
		011	2
		100	2.5
		101	3
		110	4
		111	8
15	UNUSED		
23:16	ARRAY_COMP_SELECT		Array Filter Compression Control Register Select. The Array Filter has four channels, each channel can choose one of two Array Filter Compression Threshold, Pre-Compression Gain, Compression Ratio, and Post Compression Gain settings from the FILTER_COMP2 register Table 4.
		0000	Select Setting 0
		-	-
		1111	Select Setting 1
31:24	UNUSED		

COMPRESSOR CONTROL REGISTER 2 (FILTER COMP2) (0x502h)**Table 7. Compressor Control Register 2**

BIT	NAME	VALUE	DESCRIPTION
4:0	COMP_TH		Array Filter Compressor Threshold (Setting 0)
		0000	0
		00001	0.03125
		00010	0.0325
		-	-
		10000	0.5
		-	-
		11000	0.75
		-	-
		11111	0.96875
7:5	G1_GAIN		Pre-Compression Gain (V/V) (Setting 0)
		000	2
		001	4
		010	8
		011	16
		100	32
		101	64
		110	128
		111	256
10:8	COMP_RATIO		Compression Ratio (Setting 0)
		000	1:1
		001	2:1
		010	2.66:1
		011	4:1
		100	5.33:1
		101	8:1
		110	10.66:1
111	16:1		
11	UNUSED		
14:12	POST_GAIN		Post Compression Gain (V/V) (Setting 0)
		000	1
		001	1.25
		010	1.5
		011	2
		100	2.5
		101	3
		110	4
111	8		
15	UNUSED		

Table 7. Compressor Control Register 2 (continued)

BIT	NAME	VALUE	DESCRIPTION
20:16	COMP_TH		Pre-Filter Compressor Threshold (Setting 1)
		00000	0
		00001	0.03125
		00010	0.0325
		-	-
		10000	0.5
		-	-
		11000	0.75
		-	-
		11111	0.96875
23:21	G1_GAIN		Pre-Compression Gain (V/V) (Setting 1)
		000	2
		001	4
		010	8
		011	16
		100	32
		101	64
		110	128
24:26	COMP_RATIO		Compression Ratio (Setting 1)
		000	1:1
		001	2:1
		010	2.66:1
		011	4:1
		100	5.33:1
		101	8:1
		110	10.66:1
27	UNUSED		
30:28	POST_GAIN		Post Compression Gain (V/V) (Setting 1)
		000	1
		001	1.25
		010	1.5
		011	2
		100	2.5
		101	3
		110	4
31	UNUSED		

FILTER DEBUG REGISTER 1 (FILT_DBG1) (0x504h)
Table 8. Filter Debug Register 1

BIT	NAME	VALUE	DESCRIPTION
3:0	ACC_ADDR		Accumulator Address. Selects which accumulator is read during debug mode
4	FILTER_SELECT	0	Selects Pre-Filter Accumulators
		1	Selects Array Filter Accumulators

Table 8. Filter Debug Register 1 (continued)

BIT	NAME	VALUE	DESCRIPTION
5	UNUSED		
6	STEP_ENABLE	0	Single Step Disabled
		1	Single Step Enabled
7	DBG_ENABLE	0	Debug Mode Disabled. Coefficient memory is inaccessible with Debug mode is disabled.
		1	Debug Mode Enabled. Coefficient memory is accessible when Debug mode is enabled.
31:8	UNUSED		

FILTER STATISTICS CONTROL REGISTER (FILT_STC) (0x505h)**Table 9. Filter Statistics Control Register**

BIT	NAME	VALUE	DESCRIPTION
PRE-FILTER Counter			
3:0	CH_SEL		Channel Select
		000	Channel 0
		001	Channel 1
		010	Channel 2
		011	Channel 3
		100	Channel 4
		101	Channel 5
		110	Channel 6
7:4	COUNT1_MODE		Counter 1 Mode Select. Specifies input of Counter 1
		0000	Sample Count Mode. Every audio sample is counted
		0001	Overflow. Overflow events counted
		0010	Frequency Error. Indicates input frequency not sufficient for given filter length
		1000	MAGN[7]
		1001	MAGN[7:6]
		1010	MAGN[7:5]
		1011	MAGN[7:4]
		1100	MAGN[7:3]
		1101	MAGN[7:2]
		1110	MAGN[7:1]
1111	MAGN[7:0]		
11:8	COUNT2_MODE		Counter 2 Mode Select. Specifies input of Counter 2
		0000	Sample Count Mode. Every audio sample is counted
		0001	Overflow. Overflow events counted
		0010	Frequency Error. Indicates input frequency not sufficient for given filter length
		1000	MAGN[7]
		1001	MAGN[7:6]
		1010	MAGN[7:5]
		1011	MAGN[7:4]
		1100	MAGN[7:3]
		1101	MAGN[7:2]
		1110	MAGN[7:1]
1111	MAGN[7:0]		

Table 9. Filter Statistics Control Register (continued)

BIT	NAME	VALUE	DESCRIPTION
14:12	UNUSED		
15	CLEAR	0	Counter Enabled
		1	Counter Cleared
ARRAY-FILTER Counter			
19:16	CH_SEL		Channel Select
		000	Channel 0
		001	Channel 1
		010	Channel 2
		011	Channel 3
		100	Channel 4
		101	Channel 5
		110	Channel 6
23:20	COUNT1_MODE		Counter 1 Mode Select. Specifies input of Counter 1
		0000	Sample Count Mode. Every audio sample is counted
		0001	Overflow. Overflow events counted
		0010	Frequency Error. Indicates input frequency not sufficient for given filter length
		1000	MAGN[7}
		1001	MAGN[7:6}
		1010	MAGN[7:5}
		1011	MAGN[7:4}
		1100	MAGN[7:3}
		1101	MAGN[7:2}
		1110	MAGN[7:1}
27:24	COUNT2_MODE		Counter 2 Mode Select. Specifies input of Counter 2
		0000	Sample Count Mode. Every audio sample is counted
		0001	Overflow. Overflow events counted
		0010	Frequency Error. Indicates input frequency not sufficient for given filter length
		1000	MAGN[7}
		1001	MAGN[7:6}
		1010	MAGN[7:5}
		1011	MAGN[7:4}
		1100	MAGN[7:3}
		1101	MAGN[7:2}
		1110	MAGN[7:1}
1111	MAGN[7:0}		
30:28	UNUSED		
31	CLEAR	0	Counter Enabled
		1	Counter Cleared

DELAY REGISTER (DELAY) (0x520h)
Table 10. Delay Register

BIT	NAME	VALUE	DESCRIPTION
15:0	POWER_UP_DELAY		Sets I2C Delay Time. Default 10ms delay.

Table 10. Delay Register (continued)

BIT	NAME	VALUE	DESCRIPTION
23:16	DEGLITCH_DELAY		Sets ENABLE Bit Polling Timeout. Default 32ms delay
31:24	STATE_DELAY		Sets Delay Between Power Up/Down States

ENABLE AND CLOCK CONFIGURATION REGISTER (ENABLE & CLOCKS) (0x521h)**Table 11. Enable and Clock Configuration Register**

BIT	NAME	VALUE	DESCRIPTION
0	ENABLE	0	Device Disabled in I ² C Mode
		1	Device Enabled in I ² C Mode
1	FORCE	0	Device Enabled Via SHDN <<overbar>> Pin
		1	Device Enabled Via I ² C
2	PULSE	0	SHDN<<overbar>> Requires a Stable Logic Level
		1	SHDN<<overbar>> Accepts a Pulse Input
3	RELY_ON_VREF	0	Device waits for delay time determined by STATE_DELAY to enable.
		1	Device waits for stable VREF
7:4	UNUSED		
10:8	MCLK_RATE		Selects PLL Input Divider
		000	32fs (1.536MHz)
		001	64fs (3.072MHz)
		010	128fs (6.114MHz)
		011	256fs (12.288MHz)
		100	512fs (24.576MHz)
		101	UNUSED
		110	UNUSED
11	I2S_CLK	0	MCLK Input to PLL
		1	I ² S_CLK Input to PLL
12	PMC_CLK_SEL	0	Oscillator Clock Input to Power Management Circuitry
		1	External Clock to Power Management Circuitry. Power management circuit uses MCLK or I ² S_CLK. Clock source depends on the state of I ² S_CLK. External Clock mode disables the internal oscillator.
13	HIFI	0	HiFi Mode Disabled
		1	HiFi Mode Enabled. PLL always produces a 4096fs clock.
14	QSA_CLK_STOP	0	QSA Clock Enabled
		1	QSA Clock Disabled Following Device Configuration
15	UNUSED		
16	ADC_SYNC_SEL	0	Normal Operation
		1	Reverse ADC SYNC Signal for additional timing margin at low supply voltages.
31:17	UNUSED		

DIGITAL MIXER CONTROL REGISTER (DIGITAL MIXER) (0x522h)
Table 12. Digital Mixer Control Register

BIT	NAME	VALUE	DESCRIPTION
5:0	ADC_LVL		Sets the Gain of the ADC Path (dB)
		000000	-76.5
		000001	-75
		-	1.5dB steps
		110010	-1.5
		110011	0
		110100	1.5
		-	1.5dB Steps
	111111	18	
6	MUTE	0	Normal Operation
		1	Mute
7	ZXD_DISABLE	0	Zero Crossing Detection Enabled
		1	Zero Crossing Detection Disabled
13:8	I ² S_LVL		Sets the Gain of the I ² S Path (dB)
		000000	-76.5
		000001	-75
		-	1.5dB steps
		110010	-1.5
		110011	0 (V _{OUT} = 3.36V _{RMS} with 0dBFS input)
		110100	1.5
		-	1.5dB Steps
	111111	18	
15:14	UNUSED		
16	I ² S_DSP	0	I ² S Data Not Passed to DSP
		1	I ² S Data Passed to DSP
17	ADC_DSP	0	ADC Output Not Passed to DSP
		1	ADC Output Passed to DSP
19:18	ISA_TX_SEL		Selects Input of Primary I ² S Transmitter
		00	None
		01	ADC
		10	DSP1/2
		11	DSP3/4
21:20	ISB_TX_SEL		Selects Input of Secondary I ² S Transmitter
		00	None
		01	ADC
		10	DSP1/2
		11	DSP3/4
22	I ² SA_ON	0	I ² SA Data NOT Output on $\overline{\text{SHDN}}$
		1	I ² SA Data Output on $\overline{\text{SHDN}}$
23	I ² SB_ON	0	I ² SB Data NOT Output on $\overline{\text{SHDN}}$
		1	I ² SB Data Output on $\overline{\text{SHDN}}$

Table 12. Digital Mixer Control Register (continued)

BIT	NAME	VALUE	DESCRIPTION
25:24	OUT1_SEL		Selects OUT1 Amplifier Input Source
		00	OUT1 Disabled
		01	DSP
		10	I2S
		11	ADC
27:26	OUT2_SEL		Selects OUT2 Amplifier Input Source
		00	OUT2 Disabled
		01	DSP
		10	I2S
		11	ADC
29:28	OUT3_SEL		Selects OUT3 Amplifier Input Source
		00	OUT3 Disabled
		01	DSP
		10	I2S
		11	ADC
31:30	OUT4_SEL		Selects OUT4 Amplifier Input Source
		00	OUT4 Disabled
		01	DSP
		10	I2S
		11	ADC

ANALOG CONFIGURATION REGISTER (ANALOG) (0x523h)**Table 13. Analog Configuration Register**

BIT	NAME	VALUE	DESCRIPTION
1:0	ANA_LVL		Sets ADC Preamplifier Gain (dB)
		00	0
		01	2.4
		10	3.5
		11	6
2	PARALLEL	0	Normal Operation. OUT2 and OUT3 operate as separate amplifiers.
		1	Parallel Operation. OUT2 and OUT3 operate in parallel as a single amplifier.
3	ZERO_ANA	0	Normal Operation
		1	Auto-Shutdown Mode. Automatically disables the amplifiers when no analog input is detected.
4	ZERO_DIG	0	Normal Operation
		1	Auto-Shutdown Mode. Automatically disables the amplifiers when there is no I2S input.
5	ADCTRIM	0	ADC Trim Disabled
		1	ADC Trim Enabled. Use ADC_COMP_COEFF_C0-C2 to trim ADC.
6	AUTO_SD	0	Normal Operation
		1	Fault Conditions Disable the Amplifiers
7	BYPASS_MOD	0	Normal Operation
		1	Pulse Correction Bypass. Amplifier output stages act as a buffer, passing PWM signal without correction to output.

Table 13. Analog Configuration Register (continued)

BIT	NAME	VALUE	DESCRIPTION
8	TST_SHT	0	Normal Operation
		1	Short Amplifier Inputs. Sets amplifier outputs to 50% duty cycle, minimizing click and pop during power up/down.
9	SCKT_DIS	0	Normal Operation
		1	Output Short Circuit Protection Disabled
10	TSD_DIS	0	Normal Operation
		1	Thermal Shutdown Disabled
11	PMC_TEST	0	Normal Operation
		1	PMC uses PLL Source Clock
12	SE_MOD	0	Normal Operation
		1	Single Edge Modulation Mode
31:13	UNUSED		

I²S PORT CONFIGURATION REGISTER (I²S PORT) (0x524h/0x525h)

BIT	NAME	VALUE	DESCRIPTION
0x524h			
0	STEREO	0	Mono Mode
		1	Stereo Mode
1	RX_ENABLE	0	Receive Mode Disabled
		1	Receive Mode Enabled
2	TX_ENABLE	0	Transmit Mode Disabled
		1	Transmit Mode Enabled
3	CLK_MS	0	I2S Clock Slave. Device requires an external SCLK for proper operation.
		1	I2S Clock Master. Device generates SCLK and transmits when either RX or TX mode are enabled.
4	SYNC_MS	0	I2S WS Slave. Device requires an external WS for proper operation.
		1	I2S WS Master. Device generates WS and transmits when either RX or TX mode are enabled.
5	CLOCK_PHASE	0	I2S Clock Phase. Transmit on falling edge, receive on rising edge.
		1	PCM Clock Phase. Transmit on rising edge, receive on falling edge.
6	STEREO_SYNC_PHASE	0	I2S Data Format: Left, Right
		1	I2S Data Format: Right, Left
7	SYNC_MODE	Mono	Rising edge indicates start of data word.
		0	SYNC low = Left, SYNC high = Right
		1	SYNC low = Right, SYNC high = left
13:8	HALF_CYCLE_DIVIDER		Configures the I2S port master clock half-cycle divider. Program the half-cycle divider by: (ReqDiv*2) 1
		000000	BYPASS
		000001	1
		000010	1.5
		000011	2
		-	-
		111101	31
		111110	31.5
111111	32		

BIT	NAME	VALUE	DESCRIPTION
15:14	UNUSED		
18:16	SYNTH_NUM		Sets the Clock Generator Numerator
		000	SYNTH_DENOM (1/)
		001	100/SYNTH_DENOM
		010	96/SYNTH_DENOM
		011	80/SYNTH_DENOM
		100	72/SYNTH_DENOM
		101	64/SYNTH_DENOM
		110	48/SYNTH_DENOM
19	SYNTH_DENOM	0	Clock Generator Denominator = 128
		1	Clock Generator Denominator = 125
23:20	UNUSED		
26:24	SYNC_RATE		Sets number of clock cycles before SYNC pattern repeats.
			MONO MODE
		000	8
		001	12
		010	16
		011	18
		100	20
		101	24
		110	25
		111	32
			STEREO MODE
		000	16
		01	24
		010	32
		011	36
		100	40
		101	48
		110	50
111	64		
29:27	MONO_SYNC_WIDTH		Sets SYNC symbol width in Mono Mode
		000	1
		001	2
		010	4
		011	7
		100	8
		101	11
		110	15
111	16		
31:30	UNUSED		
0x525h			

BIT	NAME	VALUE	DESCRIPTION
2:0	RX_WIDTH		Sets number of valid RECEIVE bits.
		000	24
		001	20
		010	18
		011	16
		100	14
		101	13
		110	12
5:3	TX_WIDTH		Sets number of TRANSMIT bits.
		000	24
		001	20
		010	18
		011	16
		100	14
		101	13
		110	12
7:6	TX_BIT		Sets number of pad bits after the valid Transmit bits.
		00	0
		01	1
		10	High-Z
8	RX_MODE	11	High-Z
		0	MSB Justified Receive Mode
		1	LSB Justified Receive Mode

BIT	NAME	VALUE	DESCRIPTION	
13:9	RX_MSB_POSITION		MSB location from the frame start (MSB Justified) or LSB location from the frame end (LSB Justified)	
		00000	0 (DSP/PCM LONG)	
		00001	1 (I2S/PCM SHORT)	
			00010	2
			00011	3
			00100	4
			00101	5
			00110	6
			00111	7
			01000	8
			01001	9
			01010	10
			01011	11
			01100	12
			01101	13
			01110	14
			01111	15
			10000	16
			10001	17
			10010	18
			10011	19
			10100	20
			10101	21
			10110	22
			10111	23
			11000	24
			11001	25
			11010	26
			11011	27
			11100	28
			11101	29
			11110	30
	11111	31		
14	RX_COMPAND	0	Normal Operation	
		1	Audio Data Companded	
15	RX_A/ μ LAW	0	μ Law Compand Mode	
		1	A-Law Compand Mode	
16	TX_MODE	0	MSB Justified Transmit Mode	
		1	LSB Justified Transmit Mode	

BIT	NAME	VALUE	DESCRIPTION		
21:17	TX_MSB_POSITION		MSB location from the frame start (MSB Justified) or LSB location from the frame end (LSB Justified)		
		00000	0 (DSP/PCM LONG)		
		00001	1 (I2S/PCM SHORT)		
				00010	2
				00011	3
				00100	4
				00101	5
				00110	6
				00111	7
				01000	8
				01001	9
				01010	10
				01011	11
				01100	12
				01101	13
				01110	14
				01111	15
				10000	16
				10001	17
				10010	18
				10011	19
				10100	20
				10101	21
				10110	22
				10111	23
				11000	24
				11001	25
				11010	26
				11011	27
				11100	28
				11101	29
		11110	30		
		11111	31		
22	TX_COMPAND	0	Normal Operation		
		1	Audio Data Companded		
23	TX_A/ μ LAW	0	μ Law Compand Mode		
		1	A-Law Compand Mode		
31:24	UNUSED				

ADC TRIM COEFFICIENT REGISTER (ADC_TRIM) (0x526h/0x527)
Table 14. ADC Trim Coefficient Register

BIT	NAME	VALUE	DESCRIPTION
0x526h			
15:0	ADC_COMP_COEFF_C0		Sets ADC Trim Coefficient C0
31:16	ADC_COMP_COEFF_C1		Sets ADC Trim Coefficient C1
0x527h			
15:0	ADC_COMP_COEFF_C2		Sets ADC Trim Coefficient C2

READBACK REGISTER (READBACK) (0x528h) READ-ONLY**Table 15. Readback Register**

BIT	NAME	VALUE	DESCRIPTION
0	ADCR_CLIP	1	Right Channel ADC Input Clipped
1	ADCL_CLIP	1	Left Channel ADC Input Clipped
2	ADCR_LVLCLIP	1	Right Channel ADC Output Clipped
3	ADCL_LVLCLIP	1	Left Channel ADC Output Clipped
4	I2SR_LVLCLIP	1	Right Channel I2S Output Clipped
5	I2SL_LVLCLIP	1	Left Channel I2S Output Clipped
7:6	UNUSED		
8	SHORT1	1	OUT1 Output Short Circuit
9	SHORT2	1	OUT2 Output Short Circuit
10	SHORT3	1	OUT3 Output Short Circuit
11	SHORT4	1	OUT4 Output Short Circuit
12	THERMAL	1	Thermal Shutdown Threshold Exceeded
23:13	SPARE		
31:24	UNUSED		

SYSTEM CONFIGURATION REGISTER (SYS_CONFIG) (0x530h)**Table 16. System Configuration Register**

BIT	NAME	VALUE	DESCRIPTION
6:0	DEVICE_ID		Sets LM48901 Device ID in slave mode
7	CONFIG_CLK_ENABLE	0	Configuration Loader Clock Disabled
		1	Configuration Loader Clock Enabled
14:8	ALT_DEVICE_ID		Sets Alternate Device ID in Slave Mode.
15	ALTID_ENABLE	0	Selects DEVICE_ID
		1	Selects ALT_DEVICE_ID
16	CL_REQ	0	Configuration Loader Access not Requested
		1	Configuration Loader Access Requested. I2C Master Transaction Enabled
17	CL_W	0	Configuration Loader Set to READ-ONLY
		1	Configuration Loader Set to WRITE
20:18	CL_PAGE		Sets I2C Page Mode Length
		00	Single Byte
		01	4 Bytes
		10	8 Bytes
22:21	UNUSED		
23	CL_ENABLE	0	Device Configured as I2C Slave
		1	Device Configured as I2C Master
24	MBIST0_ENABLE	0	Memory BIST Controller 0 Disabled
		1	Memory BIST Control 0 Enabled.
25	MBIST1_ENABLE	0	Memory BIST Controller 1 Disabled
		1	Memory BIST Control 1 Enabled.
31:26	UNUSED		

I²C MASTER CONFIGURATION LOADER REGISTER 0 (CL_REG0) (0x531h)
Table 17. Filter Debug Register 0

BIT	NAME	VALUE	DESCRIPTION
15:0	TRANS_LENGTH		Sets I2C Master Transaction Length
31:16	REG_START_ADDR		Starting Address of LM48901 Memory

I²C MASTER CONFIGURATION LOADER REGISTER 1 (CL_REG1) (0x532h)
Table 18. Filter Debug Register 1

BIT	NAME	VALUE	DESCRIPTION
15:0	E2_START_ADDR		Sets EEPROM Address. Indicates EEPROM start address where data is stored
31:16	UNUSED		

EEPROM ADDRESS OFFSET REGISTER (E2_OFFSET) (0x533h)
Table 19. EEPROM Address Offset Register

BIT	NAME	VALUE	DESCRIPTION
5:0	E2_OFFSET		EEPROM Address Offset Value.
31:6	UNUSED		

I²C EnXT REGISTER (I²CEnXT) (0x534h)
Table 20. I²C EnXT Register

BIT	NAME	VALUE	DESCRIPTION
5:0	E2NXT_OFFSET		Sets EEPROM Address Offset for Following LM48901 when devices are Daisy Chained.
6	UNUSED		
7	I2C_EnXT	0	Next Device in Daisy Chain Disabled. I2C_EX driven Low.
		1	Next Device in Daisy Chain Enabled. I2C_EX driven HIGH.
31:8	UNUSED		

READ-ONLY MBIST STATUS REGISTER (MBIST_STAT) (0x538h)
Table 21. MBIST Status Register

BIT	NAME	VALUE	DESCRIPTION
1:0	MBIST_DONE		Logic HIGH indicates memory test complete
3:2	BIST_GO		Logic Low indicates memory fault when MBIST_DONE is HIGH
5:4	MBIST_EN	0	MBIST Read-back Disabled
		1	MBIST Read-back Enabled
31:6	UNUSED		

DAISY CHAINING
I²C_EN/I²C_EX

The LM48901 supports daisy chaining up to 127 devices from a single I²C bus utilizing I²C_EN and I²C_EX in a chain enable scheme. I²C_EX is a push/pull logic output that drives the I²C_EN of the following device in the chain [Figure 14](#). At power up, I²C_EnXT (bit 8, I²C_EnXT Register [0x534h]) is set to 0, resulting in I²C_EN driven low, disabling the I²C interface of the following device. Once device configuration is complete, and I²C_EnXT is set to 1, I²C_EN is driven high, enabling the I²C interface of the following device. Driving I²C_EN high enables the device's I²C interface, driving I²C_EN low disables the device's I²C interface.

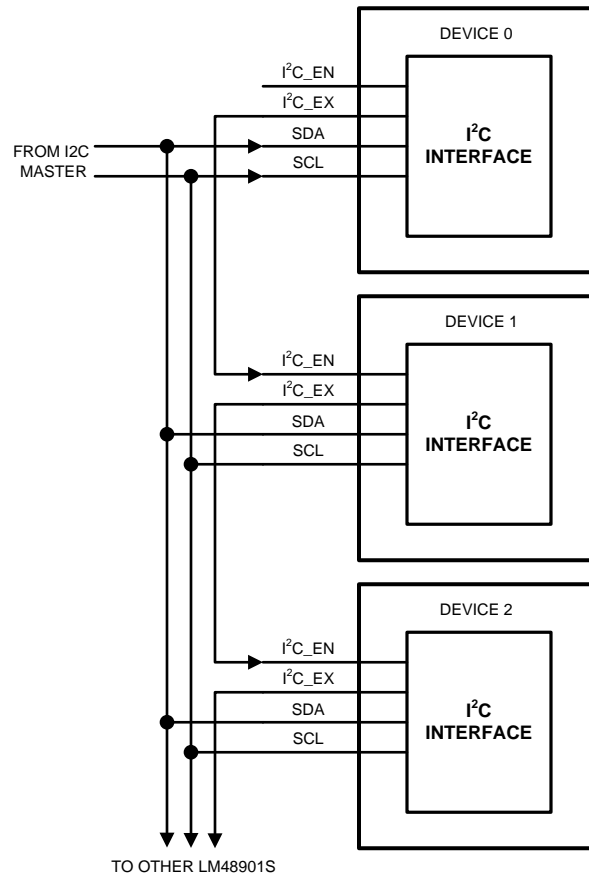

Figure 14. I²C_EN/I²C_EX Daisy Chaining Example

Device Address

The 0110000X is the default LM48901 I²C address hard coded into the device. Two alternate device addresses can be programmed, via the SYS CONFIG (0x530h) Register. Use the default address during initial device configuration.

GENERAL AMPLIFIER FUNCTION

Class D Amplifier

The LM48901 features four high-efficiency Class D audio power amplifiers that utilizes Texas Instruments' filterless modulation scheme external component count, conserving board space and reducing system cost. The Class D outputs transition from V_{DD} to GND with a 384kHz switching frequency. With no signal applied, the outputs switch with a 50% duty cycle, in phase, causing the two outputs to cancel. This cancellation results in no net voltage across the speaker, thus there is no current to the load in the idle state.

With the input signal applied, the duty cycle (pulse width) of the LM48901 outputs changes. For increasing output voltage, the duty cycle of OUT₊ increases while the duty cycle of OUT₋ decreases. For decreasing output voltages, the converse occurs. The difference between the two pulse widths yield the differential output voltage.

Edge Rate Control (ERC)

The LM48901 features Texas Instruments' advanced edge rate control (ERC) that reduces EMI, while maintaining high quality audio reproduction and efficiency. The LM48901 ERC greatly reduces the high frequency components of the output square waves by controlling the output rise and fall times, slowing the transitions to reduce RF emissions, while maximizing THD+N and efficiency performance. The overall result of the E²S system is a filterless Class D amplifier that passes FCC Class B radiated emissions standards with 24in of twisted pair cable, with excellent 0.06% THD+N and high 89% efficiency.

POWER DISSIPATION AND EFFICIENCY

The major benefit of a Class D amplifier is increased efficiency versus a Class AB. The efficiency of the LM48901 is attributed to the region of operation of the transistors in the output stage. The Class D output stage acts as current steering switches, consuming negligible amounts of power compared to their Class AB counterparts. Most of the power loss associated with the output stage is due to the IR loss of the MOSFET on-resistance, along with switching losses due to gate charge.

ANALOG INPUT

The LM48901 features a differential input, stereo ADC for analog systems. A differential amplifier amplifies the difference between the two input signals. Traditional audio power amplifiers have typically offered only single-ended inputs resulting in a 6dB reduction of SNR relative to differential inputs. The LM48901 also offers the possibility of DC input coupling which eliminates the input coupling capacitors. A major benefit of the fully differential amplifier is the improved common mode rejection ratio (CMRR) over single ended input amplifiers. The increased CMRR of the differential amplifier reduces sensitivity to ground offset related noise injection, especially important in noisy systems.

PARALLEL MODE

In Parallel mode, channels OUT2 and OUT3 are driven from the same audio source, allowing the two channels to be connected in parallel, increasing output power to 3.2W into 4Ω at 10% THD+N. Set bit 2 (PARALLEL) of the Analog Configuration Register (0x532h) = 1 to configured the device in Parallel mode. After the device is set to Parallel mode, make an external connection between OUT2+ and OUT3+, and a connection between OUT2- and OUT3- (Figure 2). In Parallel mode, the combined channels are driven from the OUT2 source. OUT1 and OUT4 are unaffected. Signal routing, mixing, filtering, and equalization are done through the Spatial Engine.

Make sure the device is configured in Parallel mode, before connecting OUT2 and OUT3 and enabling the outputs. Do not make a connection between OUT2 and OUT3 together while the outputs are enabled. Disable the outputs first, then make the connections between OUT2 and OUT3.

GAIN SETTING

The LM48901 has three gain stages, the ADC preamplifier, and two independent volume controls in the Digital Mixer, one for the ADC path and one for the I²S path. The ADC preamplifier has four gain settings (0dB, 2.4dB, 3.5dB, and 6dB). The preamplifier gain is set by bits 0 and 1 (ANA_LVL) of the Analog Configuration Register (0x523h). The Digital Mixer has two 64 step volume controls. The ADC path volume control is set by bits 5:0 (ADC_LVL) in the Digital Mixer Control Register (0x522h). The I²S path volume control is set by bits 13:8 (I²S_LVL) in the Digital Mixer Control Register (0x522h). Both volume controls have a range of -76.5dB to 18dB in 1.5dB increments.

MODULATOR POWER SUPPLY (AV_{DD1})

The AV_{DD1} (R_L package: bump C2, SQ package: pin 12) powers the class D modulators. For maximum output swing, set AV_{DD1} and PV_{DD} to the same voltage. [Table 22](#) shows the output voltage for different AV_{DD1} levels.

Table 22. Amplifier Output Voltage with Variable AV_{DD1} Voltage

AV _{DD1} (V)	V _{OUT} (V _{RMS}) @ PV _{DD} = 5V, THD+N = 1%	V _{OUT} (V _{RMS}) @ PV _{DD} = 3.6V, THD+N = 1%
5	3.3	-
4.5	3.1	-
4.2	2.9	-
4	2.7	-
3.6	2.5	2.4
3.3	2.3	2.2
3	2.1	2.1
2.8	2	1.9

CLOCK REQUIREMENTS

The LM48901 requires an external clock source for proper operation, regardless of input source or device configuration. The device derives the ADC, digital mixer, DSP, I²S port, and PWM clocks from the external clock. The clock can be derived from either MCLK or SCLK inputs. Set bit 11 (I²S_CLK) of the Enable and Clock configuration register (0x521h) to 0 to select MCLK, set I²S_CLK to 1 to select SCLK. The LM48901 accepts five different clock frequencies, 1.536, 3.072, 6.114, 12.288, and 24.576MHz. Set bits 10:8 (MCLK_RATE) of the Enable and Clock Configuration Register to the appropriate clock frequency. In systems where both MCLK and SCLK are available, choose the lower frequency clock for improved power consumption.

SHUTDOWN FUNCTION

There are two ways to shutdown the LM48901, hardware mode, and software mode. The default is hardware mode.

Set bit 1 (FORCE) of the Enable and Clock Configuration Register (0x521h) to 0 to enable hardware shutdown mode. In hardware mode, the device is enabled and disabled through SHDN. Connect SHDN to V_{DD} for normal operation. Connect SHDN to GND to disable the device. Hardware shutdown mode supports a one shot, or momentary switch SHDN input. When bit 2 (PULSE) of the Enable and Clock Configuration Register (0x521h) is set to 1, the LM48901 responds to a rising edge on SHDN to change the device state. When PULSE = 0, the device requires a stable logic level on SHDN.

Set FORCE = 1 to enable software shutdown mode. In software shutdown mode, the device is enabled and disabled through bit 0 (ENABLE) of the Enable and Clock Configuration Register (0x512h). Set ENABLE = 0 to disable the LM48901. Set ENABLE = 1 to enable the LM48901.

In either hardware or software mode, the content of the LM48901 memory registers is retained after the device is disabled, as long as power is still applied to the device. Minimize power consumption by disabling the PMC clock oscillator when the LM48901 is shutdown. Set bit 12 (PMC_CLK_SEL) and bit 14 (QSA_CLK_STOP) of the Enable and Clock configuration Register (0x521h) = 1 to disable the PMC clock oscillator.

EXTERNAL CAPACITOR SELECTION

Power Supply Bypassing and Filtering

Proper power supply bypassing is critical for low noise performance and high PSRR. Place the supply bypass capacitors as close to the device as possible. Typical applications employ a voltage regulator with 10μF and 0.1μF bypass capacitors that increase supply stability. These capacitors do not eliminate the need for bypassing of the LM48901 supply pins. A 1μF capacitor is recommended for IOV_{DD}, PLLV_{DD}, DV_{DD}, and AV_{DD}. A 2.2μF capacitor is recommended for PV_{DD}.

REF and BYPASS Capacitor Selection

For best performance, bypass REF with a 4.7μF ceramic capacitor.

INPUT CAPACITOR SELECTION

The LM48901 analog inputs require input coupling capacitors. Input capacitors block the DC component of the audio signal, eliminating any conflict between the DC component of the audio source and the bias voltage of the LM48901. The input capacitors create a high-pass filter with the input resistors R_{IN}. The -3dB point of the high pass filter is found using Equation (1) below.

$$f = 1 / 2\pi R_{IN} C_{IN} \quad (1)$$

Where the value of R_{IN} is 20kΩ.

The input capacitors can also be used to remove low frequency content from the audio signal. Small speakers cannot reproduce, and may even be damaged by low frequencies. High pass filtering the audio signal helps protect the speakers. When the LM48901 is using a single-ended source, power supply noise on the ground is seen as an input signal. Setting the high-pass filter point above the power supply noise frequencies, 217Hz in a GSM phone, for example, filters out the noise such that it is not amplified and heard on the output. Capacitors with a tolerance of 10% or better are recommended for impedance matching and improved CMRR and PSRR.

PCB LAYOUT GUIDELINES

As output power increases, interconnect resistance (PCB traces and wires) between the amplifier, load, and power supply create a voltage drop. The voltage loss due to the traces between the LM48901 and the load results in lower output power and decreased efficiency. Higher trace resistance between the supply and the LM48901 has the same effect as a poorly regulated supply, increasing ripple on the supply line, and reducing peak output power. The effects of residual trace resistance increases as output current increases due to higher output power, decreased load impedance or both. To maintain the highest output voltage swing and corresponding peak output power, the PCB traces that connect the output pins to the load and the supply pins to the power supply should be as wide as possible to minimize trace resistance.

The use of power and ground planes will give the best THD+N performance. In addition to reducing trace resistance, the use of power planes creates parasitic capacitors that help to filter the power supply line.

The inductive nature of the transducer load can also result in overshoot on one of both edges, clamped by the parasitic diodes to GND and V_{DD} in each case. From an EMI standpoint, this is an aggressive waveform that can radiate or conduct to other components in the system and cause interference. It is essential to keep the power and output traces short and well shielded if possible. Use of ground planes beads and micro-strip layout techniques are all useful in preventing unwanted interference.

As the distance from the LM48901 and the speaker increases, the amount of EMI radiation increases due to the output wires or traces acting as antennas become more efficient with length. Ferrite chip inductors placed close to the LM48901 outputs may be needed to reduce EMI radiation.

Revision History

Rev	Date	Description
1.0	10/31/11	Initial Web released.
1.01	12/02/11	Fixed a typo (LM488901 to LM48901) on page 45.
1.02	12/12/11	Added two sections "Modulator Power Supply" and Clock Requirements.
1.03	12/16/11	Changed National to Texas Instruments.

PACKAGING INFORMATION

Orderable Device	Status (1)	Package Type	Package Drawing	Pins	Package Qty	Eco Plan (2)	Lead/Ball Finish	MSL Peak Temp (3)	Op Temp (°C)	Top-Side Markings (4)	Samples
LM48901RL/NOPB	ACTIVE	DSBGA	YPG	36	250	Green (RoHS & no Sb/Br)	SNAG	Level-1-260C-UNLIM	-40 to 85	GO2	Samples
LM48901RLX/NOPB	ACTIVE	DSBGA	YPG	36	1000	Green (RoHS & no Sb/Br)	SNAG	Level-1-260C-UNLIM	-40 to 85	GO2	Samples
LM48901SQ/NOPB	ACTIVE	WQFN	RTV	32	1000	Green (RoHS & no Sb/Br)	CU SN	Level-1-260C-UNLIM	-40 to 85	L48901	Samples
LM48901SQE/NOPB	ACTIVE	WQFN	RTV	32	250	Green (RoHS & no Sb/Br)	CU SN	Level-1-260C-UNLIM	-40 to 85	L48901	Samples
LM48901SQX/NOPB	ACTIVE	WQFN	RTV	32	4500	Green (RoHS & no Sb/Br)	CU SN	Level-1-260C-UNLIM	-40 to 85	L48901	Samples

(1) The marketing status values are defined as follows:

ACTIVE: Product device recommended for new designs.

LIFEBUY: TI has announced that the device will be discontinued, and a lifetime-buy period is in effect.

NRND: Not recommended for new designs. Device is in production to support existing customers, but TI does not recommend using this part in a new design.

PREVIEW: Device has been announced but is not in production. Samples may or may not be available.

OBSELETE: TI has discontinued the production of the device.

(2) Eco Plan - The planned eco-friendly classification: Pb-Free (RoHS), Pb-Free (RoHS Exempt), or Green (RoHS & no Sb/Br) - please check <http://www.ti.com/productcontent> for the latest availability information and additional product content details.

TBD: The Pb-Free/Green conversion plan has not been defined.

Pb-Free (RoHS): TI's terms "Lead-Free" or "Pb-Free" mean semiconductor products that are compatible with the current RoHS requirements for all 6 substances, including the requirement that lead not exceed 0.1% by weight in homogeneous materials. Where designed to be soldered at high temperatures, TI Pb-Free products are suitable for use in specified lead-free processes.

Pb-Free (RoHS Exempt): This component has a RoHS exemption for either 1) lead-based flip-chip solder bumps used between the die and package, or 2) lead-based die adhesive used between the die and leadframe. The component is otherwise considered Pb-Free (RoHS compatible) as defined above.

Green (RoHS & no Sb/Br): TI defines "Green" to mean Pb-Free (RoHS compatible), and free of Bromine (Br) and Antimony (Sb) based flame retardants (Br or Sb do not exceed 0.1% by weight in homogeneous material)

(3) MSL, Peak Temp. -- The Moisture Sensitivity Level rating according to the JEDEC industry standard classifications, and peak solder temperature.

(4) Multiple Top-Side Markings will be inside parentheses. Only one Top-Side Marking contained in parentheses and separated by a "~" will appear on a device. If a line is indented then it is a continuation of the previous line and the two combined represent the entire Top-Side Marking for that device.

Important Information and Disclaimer: The information provided on this page represents TI's knowledge and belief as of the date that it is provided. TI bases its knowledge and belief on information provided by third parties, and makes no representation or warranty as to the accuracy of such information. Efforts are underway to better integrate information from third parties. TI has taken and continues to take reasonable steps to provide representative and accurate information but may not have conducted destructive testing or chemical analysis on incoming materials and chemicals. TI and TI suppliers consider certain information to be proprietary, and thus CAS numbers and other limited information may not be available for release.

In no event shall TI's liability arising out of such information exceed the total purchase price of the TI part(s) at issue in this document sold by TI to Customer on an annual basis.

TAPE AND REEL INFORMATION

QUADRANT ASSIGNMENTS FOR PIN 1 ORIENTATION IN TAPE

*All dimensions are nominal

Device	Package Type	Package Drawing	Pins	SPQ	Reel Diameter (mm)	Reel Width W1 (mm)	A0 (mm)	B0 (mm)	K0 (mm)	P1 (mm)	W (mm)	Pin1 Quadrant
LM48901RL/NOPB	DSBGA	YPG	36	250	178.0	12.4	3.43	3.59	0.76	8.0	12.0	Q1
LM48901RLX/NOPB	DSBGA	YPG	36	1000	178.0	12.4	3.43	3.59	0.76	8.0	12.0	Q1
LM48901SQ/NOPB	WQFN	RTV	32	1000	178.0	12.4	5.3	5.3	1.3	8.0	12.0	Q1
LM48901SQE/NOPB	WQFN	RTV	32	250	178.0	12.4	5.3	5.3	1.3	8.0	12.0	Q1
LM48901SQX/NOPB	WQFN	RTV	32	4500	330.0	12.4	5.3	5.3	1.3	8.0	12.0	Q1

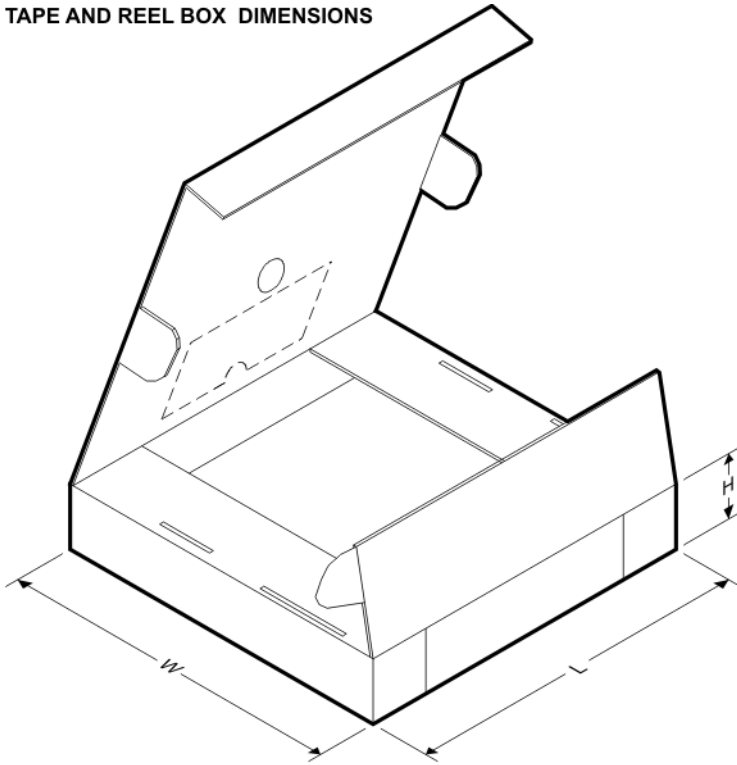
TAPE AND REEL BOX DIMENSIONS

*All dimensions are nominal

Device	Package Type	Package Drawing	Pins	SPQ	Length (mm)	Width (mm)	Height (mm)
LM48901RL/NOPB	DSBGA	YPG	36	250	210.0	185.0	35.0
LM48901RLX/NOPB	DSBGA	YPG	36	1000	210.0	185.0	35.0
LM48901SQ/NOPB	WQFN	RTV	32	1000	210.0	185.0	35.0
LM48901SQE/NOPB	WQFN	RTV	32	250	210.0	185.0	35.0
LM48901SQX/NOPB	WQFN	RTV	32	4500	367.0	367.0	35.0

RTV0032A

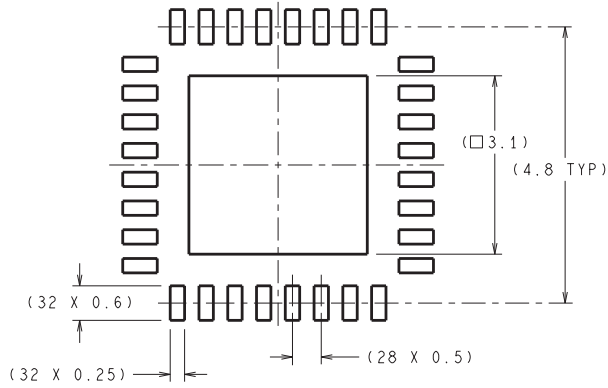

DIMENSIONS ARE IN MILLIMETERS
DIMENSIONS IN () FOR REFERENCE ONLY



RECOMMENDED LAND PATTERN

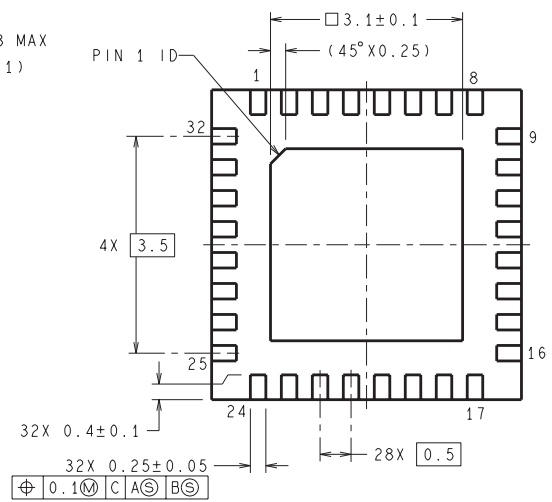
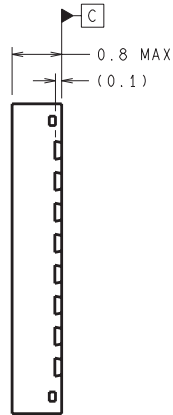
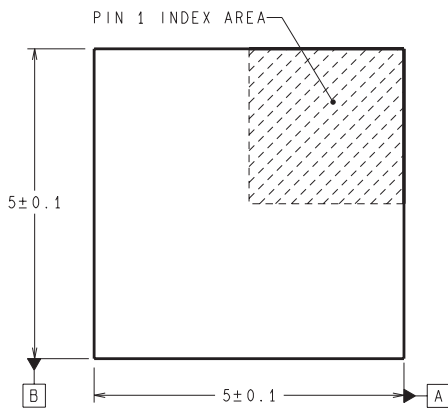

SQA32A (Rev B)

YPG0036

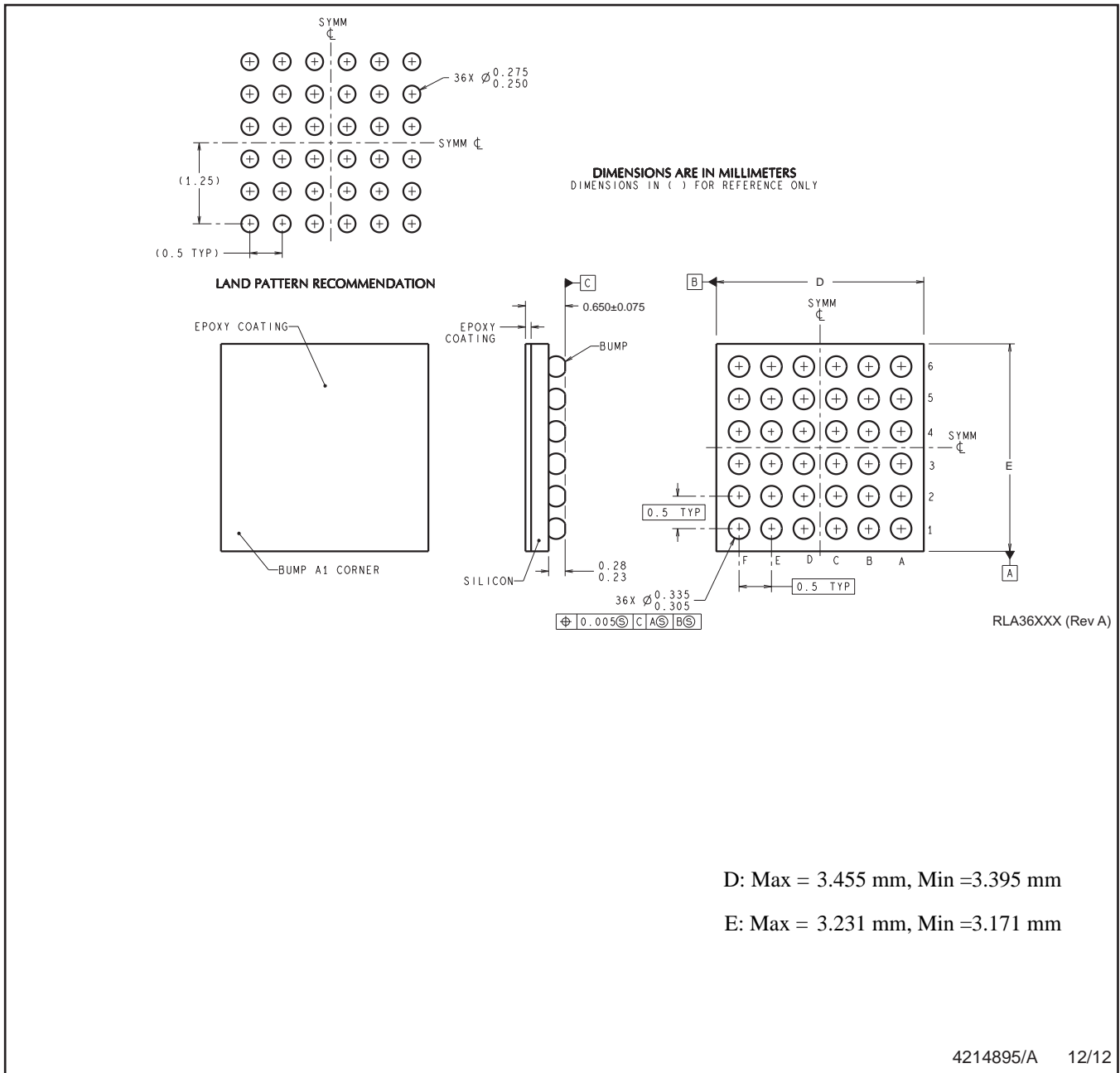

4214895/A 12/12

NOTES: A. All linear dimensions are in millimeters. Dimensioning and tolerancing per ASME Y14.5M-1994.
B. This drawing is subject to change without notice.

IMPORTANT NOTICE

Texas Instruments Incorporated and its subsidiaries (TI) reserve the right to make corrections, enhancements, improvements and other changes to its semiconductor products and services per JESD46, latest issue, and to discontinue any product or service per JESD48, latest issue. Buyers should obtain the latest relevant information before placing orders and should verify that such information is current and complete. All semiconductor products (also referred to herein as "components") are sold subject to TI's terms and conditions of sale supplied at the time of order acknowledgment.

TI warrants performance of its components to the specifications applicable at the time of sale, in accordance with the warranty in TI's terms and conditions of sale of semiconductor products. Testing and other quality control techniques are used to the extent TI deems necessary to support this warranty. Except where mandated by applicable law, testing of all parameters of each component is not necessarily performed.

TI assumes no liability for applications assistance or the design of Buyers' products. Buyers are responsible for their products and applications using TI components. To minimize the risks associated with Buyers' products and applications, Buyers should provide adequate design and operating safeguards.

TI does not warrant or represent that any license, either express or implied, is granted under any patent right, copyright, mask work right, or other intellectual property right relating to any combination, machine, or process in which TI components or services are used. Information published by TI regarding third-party products or services does not constitute a license to use such products or services or a warranty or endorsement thereof. Use of such information may require a license from a third party under the patents or other intellectual property of the third party, or a license from TI under the patents or other intellectual property of TI.

Reproduction of significant portions of TI information in TI data books or data sheets is permissible only if reproduction is without alteration and is accompanied by all associated warranties, conditions, limitations, and notices. TI is not responsible or liable for such altered documentation. Information of third parties may be subject to additional restrictions.

Resale of TI components or services with statements different from or beyond the parameters stated by TI for that component or service voids all express and any implied warranties for the associated TI component or service and is an unfair and deceptive business practice. TI is not responsible or liable for any such statements.

Buyer acknowledges and agrees that it is solely responsible for compliance with all legal, regulatory and safety-related requirements concerning its products, and any use of TI components in its applications, notwithstanding any applications-related information or support that may be provided by TI. Buyer represents and agrees that it has all the necessary expertise to create and implement safeguards which anticipate dangerous consequences of failures, monitor failures and their consequences, lessen the likelihood of failures that might cause harm and take appropriate remedial actions. Buyer will fully indemnify TI and its representatives against any damages arising out of the use of any TI components in safety-critical applications.

In some cases, TI components may be promoted specifically to facilitate safety-related applications. With such components, TI's goal is to help enable customers to design and create their own end-product solutions that meet applicable functional safety standards and requirements. Nonetheless, such components are subject to these terms.

No TI components are authorized for use in FDA Class III (or similar life-critical medical equipment) unless authorized officers of the parties have executed a special agreement specifically governing such use.

Only those TI components which TI has specifically designated as military grade or "enhanced plastic" are designed and intended for use in military/aerospace applications or environments. Buyer acknowledges and agrees that any military or aerospace use of TI components which have **not** been so designated is solely at the Buyer's risk, and that Buyer is solely responsible for compliance with all legal and regulatory requirements in connection with such use.

TI has specifically designated certain components as meeting ISO/TS16949 requirements, mainly for automotive use. In any case of use of non-designated products, TI will not be responsible for any failure to meet ISO/TS16949.

Products

Audio	www.ti.com/audio
Amplifiers	amplifier.ti.com
Data Converters	dataconverter.ti.com
DLP® Products	www.dlp.com
DSP	dsp.ti.com
Clocks and Timers	www.ti.com/clocks
Interface	interface.ti.com
Logic	logic.ti.com
Power Mgmt	power.ti.com
Microcontrollers	microcontroller.ti.com
RFID	www.ti-rfid.com
OMAP Applications Processors	www.ti.com/omap
Wireless Connectivity	www.ti.com/wirelessconnectivity

Applications

Automotive and Transportation	www.ti.com/automotive
Communications and Telecom	www.ti.com/communications
Computers and Peripherals	www.ti.com/computers
Consumer Electronics	www.ti.com/consumer-apps
Energy and Lighting	www.ti.com/energy
Industrial	www.ti.com/industrial
Medical	www.ti.com/medical
Security	www.ti.com/security
Space, Avionics and Defense	www.ti.com/space-avionics-defense
Video and Imaging	www.ti.com/video

TI E2E Community

e2e.ti.com

Looking for pricing, stock, or lifecycle information?

Click below to explore more details on WIN SOURCE:

 [View LM48901RL/NOPB on WIN SOURCE](#)

 [Texas Instruments](#) Information

Optimize Your Supply Chain with WIN SOURCE Solutions

-  Global Sourcing Solution
-  Obsolete Management
-  Cost Control Management
-  Shortage Management
-  Alternative Solution
-  Excess Inventory Management