



**THE DATASHEET OF
LM4860MX**



LM4860 Boomer® Audio Power Amplifier Series **Series 1W Audio Power Amplifier with Shutdown Mode**

Check for Samples: [LM4860](#)

FEATURES

- **No Output Coupling Capacitors, Bootstrap Capacitors, or Snubber Circuits are Necessary**
- **Small Outline (SO) Packaging**
- **Compatible with PC Power Supplies**
- **Thermal Shutdown Protection Circuitry**
- **Unity-Gain Stable**
- **External Gain Configuration Capability**
- **Two Headphone Control Inputs and Headphone Sensing Output**

APPLICATIONS

- **Personal Computers**
- **Portable Consumer Products**
- **Cellular Phones**
- **Self-Powered Speakers**
- **Toys and Games**

KEY SPECIFICATIONS

- **THD+N at 1W Continuous Average**
- **Output Power into 8Ω: 1% (Max)**
- **Instantaneous Peak Output Power: > 2 W**
- **Shutdown Current: 0.6 μA (typ)**

DESCRIPTION

The LM4860 is a bridge-connected audio power amplifier capable of delivering 1W of continuous average power to an 8Ω load with less than 1% THD+N over the audio spectrum from a 5V power supply.

Boomer audio power amplifiers were designed specifically to provide high quality output power with a minimal amount of external components using surface mount packaging. Since the LM4860 does not require output coupling capacitors, bootstrap capacitors or snubber networks, it is optimally suited for low-power portable systems.

The LM4860 features an externally controlled, low-power consumption shutdown mode, as well as an internal thermal shutdown protection mechanism. It also includes two headphone control inputs and a headphone sense output for external monitoring.

The unity-gain stable LM4860 can be configured by external gain setting resistors for differential gains of up to 10 without the use of external compensation components. Higher gains may be achieved with suitable compensation.



Please be aware that an important notice concerning availability, standard warranty, and use in critical applications of Texas Instruments semiconductor products and disclaimers thereto appears at the end of this data sheet.

All trademarks are the property of their respective owners.

Typical Application

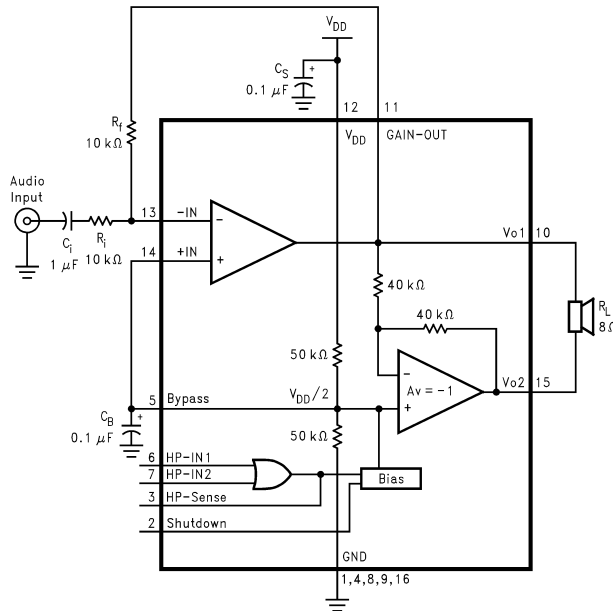

Figure 1. Typical Audio Amplifier Application Circuit

Connection Diagram

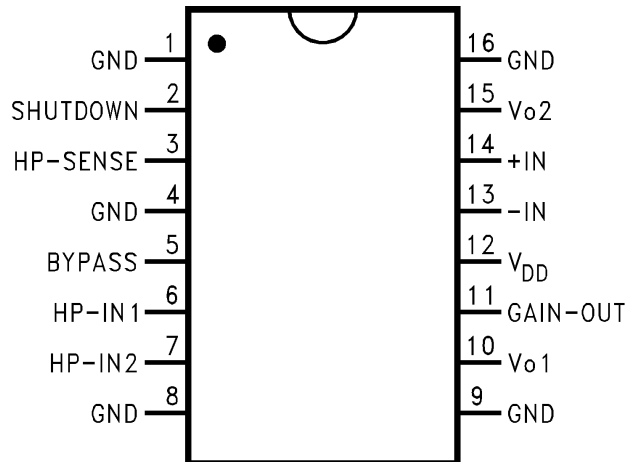

Figure 2. SOIC Package- Top View
See Package Number D0016A



These devices have limited built-in ESD protection. The leads should be shorted together or the device placed in conductive foam during storage or handling to prevent electrostatic damage to the MOS gates.

Absolute Maximum Ratings ⁽¹⁾⁽²⁾

Supply Voltage			6.0V
Storage Temperature			-65°C to +150°C
Input Voltage			-0.3V to $V_{DD} + 0.3V$
Power Dissipation			Internally limited
ESD Susceptibility ⁽³⁾			3000V
ESD Susceptibility ⁽⁴⁾			250V
Junction Temperature			150°C
Soldering Information	SOIC Package	Vapor Phase (60 sec.)	215°C
		Infrared (15 sec.)	220°C

- (1) Absolute Maximum Ratings indicate limits beyond which damage to the device may occur. Operating Ratings indicate conditions for which the device is functional, but do not ensure specific performance limits. Electrical Characteristics state DC and AC electrical specifications under particular test conditions which ensure specific performance limits. This assumes that the device is within the Operating Ratings. Specifications are not ensured for parameters where no limit is given, however, the typical value is a good indication of device performance.
- (2) If Military/Aerospace specified devices are required, please contact the Texas Instruments Sales Office/ Distributors for availability and specifications.
- (3) Human body model, 100 pF discharged through a 1.5 kΩ resistor.
- (4) Machine Model, 200 pF–240 pF discharged through all pins.

Operating Ratings

Temperature Range	$T_{MIN} \leq T_A \leq T_{MAX}$	$-20^\circ\text{C} \leq T_A \leq +85^\circ\text{C}$
Supply Voltage		$2.7V \leq V_{DD} \leq 5.5V$

Electrical Characteristics

The following specifications apply for $V_{DD} = 5V$, $R_L = 8\Omega$ unless otherwise specified. Limits apply for $T_A = 25^\circ\text{C}$. ⁽¹⁾⁽²⁾

Parameter		Test Conditions	LM4860		Units (Limits)
			Typ ⁽³⁾	Limit ⁽⁴⁾	
V_{DD}	Supply Voltage			2.7	V (min)
				5.5	V (max)
I_{DD}	Quiescent Power Supply Current	$V_O = 0V$, $I_O = 0A$ ⁽⁵⁾	7.0	15.0	mA (max)
I_{SD}	Shutdown Current	$V_{pin2} = V_{DD}$ ⁽⁶⁾	0.6		μA
V_{OS}	Output Offset Voltage	$V_{IN} = 0V$	5.0	50.0	mV (max)
P_O	Output Power	THD+N = 1% (max); $f = 1\text{ kHz}$	1.15	1.0	W (min)
THD+N	Total Harmonic Distortion + Noise	$P_O = 1\text{ Wrms}$; $20\text{ Hz} \leq f \leq 20\text{ kHz}$	0.72		%
PSRR	Power Supply Rejection Ratio	$V_{DD} = 4.9V$ to $5.1V$	65		dB
V_{od}	Output Dropout Voltage	$V_{IN} = 0V$ to $5V$, $V_{od} = (V_{o1} - V_{o2})$	0.6	1.0	V (max)
V_{IH}	HP-IN High Input Voltage	HP-SENSE = $0V$ to $4V$	2.5		V
V_{IL}	HP-IN Low Input Voltage	HP-SENSE = $4V$ to $0V$	2.5		V
V_{OH}	HP-SENSE High Output Voltage	$I_O = 500\ \mu A$	2.8	2.5	V (min)
V_{OL}	HP-SENSE Low Output Voltage	$I_O = -500\ \mu A$	0.2	0.8	V (max)

- (1) All voltages are measured with respect to the ground pins, unless otherwise specified.
- (2) Absolute Maximum Ratings indicate limits beyond which damage to the device may occur. Operating Ratings indicate conditions for which the device is functional, but do not ensure specific performance limits. Electrical Characteristics state DC and AC electrical specifications under particular test conditions which ensure specific performance limits. This assumes that the device is within the Operating Ratings. Specifications are not ensured for parameters where no limit is given, however, the typical value is a good indication of device performance.
- (3) Typicals are measured at 25°C and represent the parametric norm.
- (4) Limits are specified to Texas Instrument's AOQL (Average Outgoing Quality Level).
- (5) The quiescent power supply current depends on the offset voltage when a practical load is connected to the amplifier.
- (6) Shutdown current has a wide distribution. For Power Management sensitive designs, contact your local Texas Instruments Sales Office.

High Gain Application Circuit

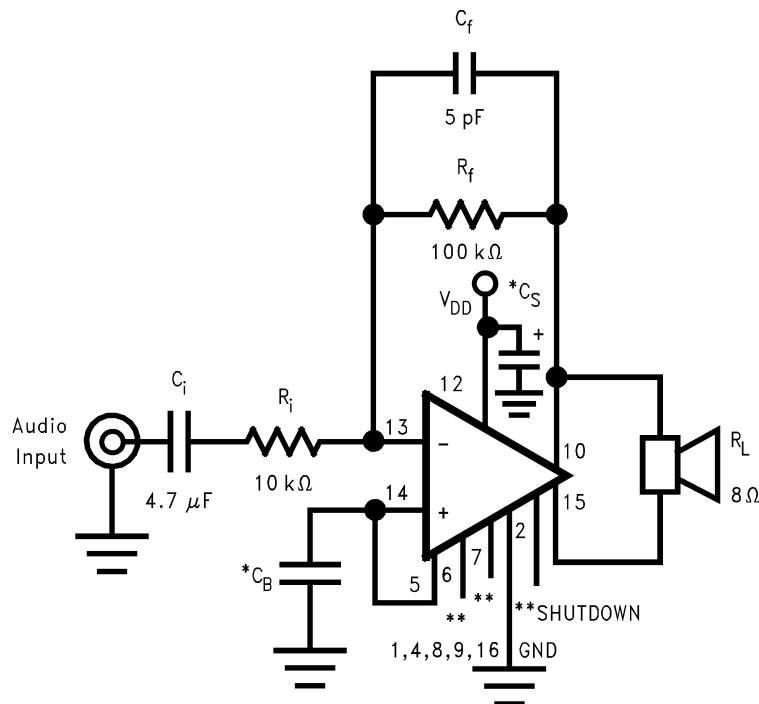
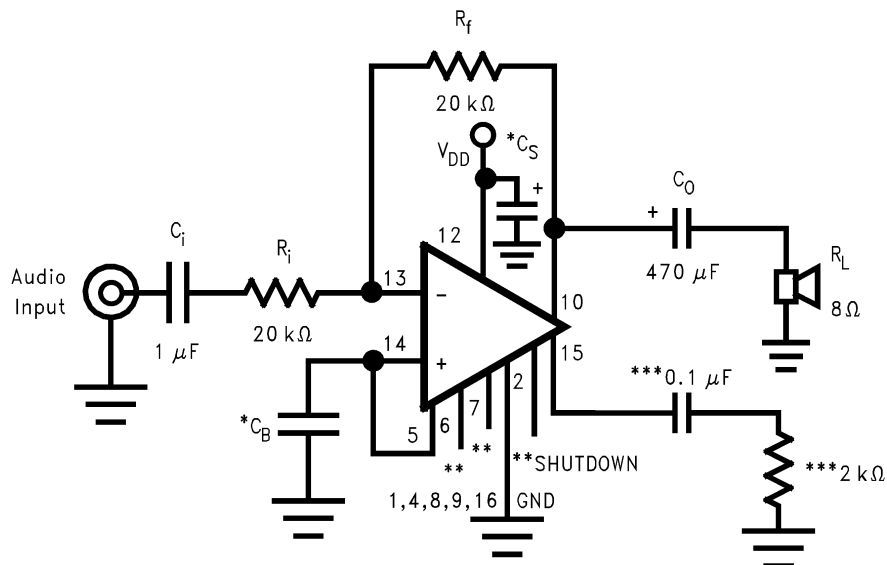

Figure 3. Stereo Amplifier with $A_{VD} = 20$

Single Ended Application Circuit



* C_S and C_B size depend on specific application requirements and constraints. Typical values of C_S and C_B are $0.1 \mu\text{F}$.

**Pin 2, 6, or 7 should be connected to V_{DD} to disable the amplifier or to GND to enable the amplifier. These pins should not be left floating.

***These components create a “dummy” load for pin 8 for stability purposes.

Figure 4. Single-Ended Amplifier with $A_V = -1$

External Components Description

(See [Figure 1](#) and [Figure 3](#))

Components		Functional Description
1.	R_i	Inverting input resistance which sets the closed-loop gain in conjunction with R_f . This resistor also forms a high pass filter with C_i at $f_C = 1/(2\pi R_i C_i)$.
2.	C_i	Input coupling capacitor which blocks DC voltage at the amplifier's input terminals. Also creates a high pass filter with R_i at $f_C = 1/(2\pi R_i C_i)$.
3.	R_f	Feedback resistance which sets closed-loop gain in conjunction with R_i .
4.	C_S	Supply bypass capacitor which provides power supply filtering. Refer to Application Information for proper placement and selection of supply bypass capacitor.
5.	C_B	Bypass pin capacitor which provides half supply filtering. Refer to Application Information for proper placement and selection of bypass capacitor.
6.	$C_f^{(1)}$	Used when a differential gain of over 10 is desired. C_f in conjunction with R_f creates a low-pass filter which bandwidth limits the amplifier and prevents high frequency oscillation bursts. $f_C = 1/(2\pi R_f C_f)$

(1) Optional component dependent upon specific design requirements. Refer to [Application Information](#) for more in formation.

Typical Performance Characteristics

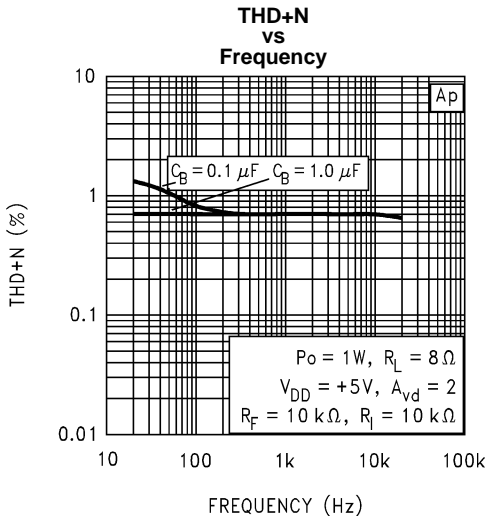

Figure 5.

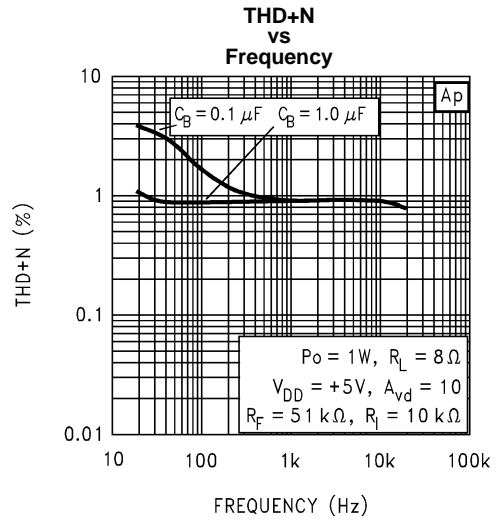

Figure 6.

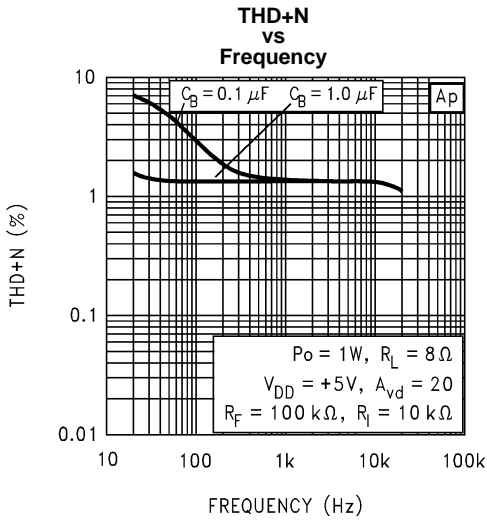

Figure 7.

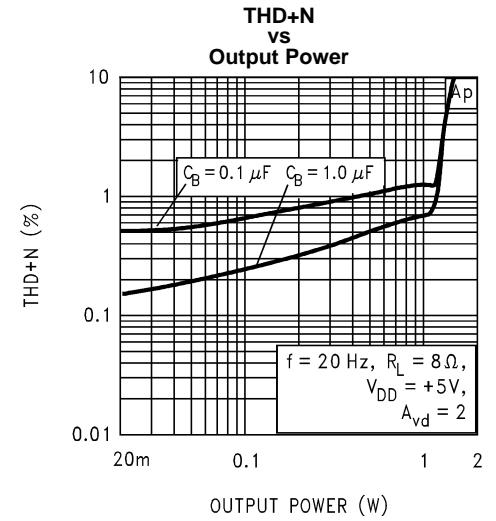

Figure 8.

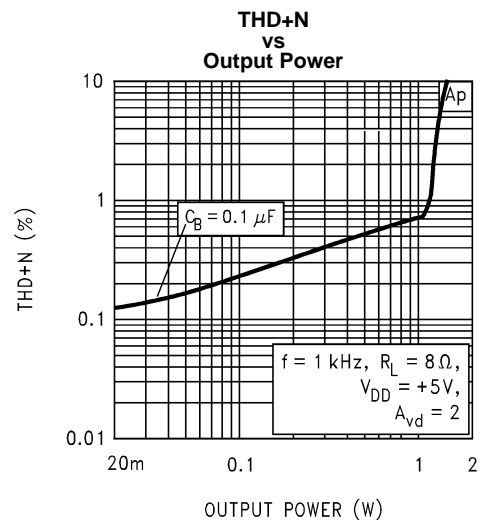

Figure 9.

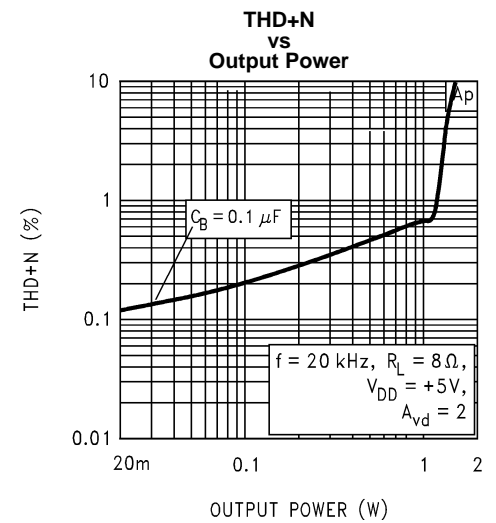

Figure 10.

Typical Performance Characteristics (continued)

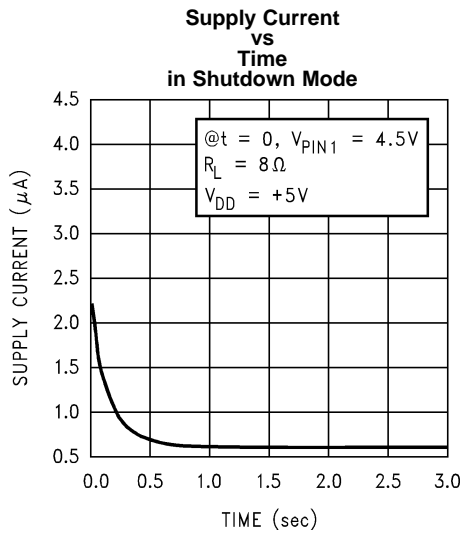

Figure 11.

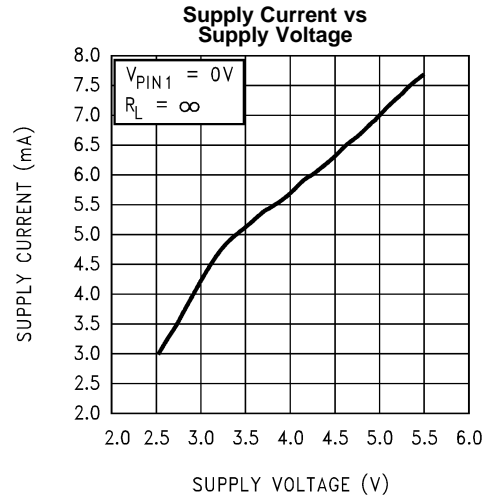

Figure 12.

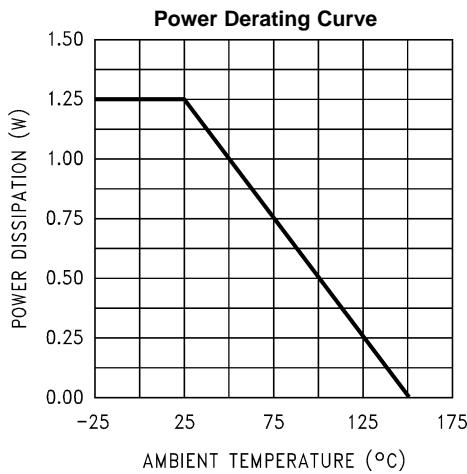

Figure 13.

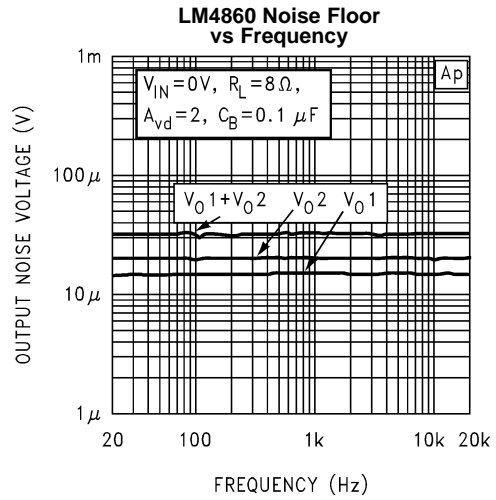

Figure 14.

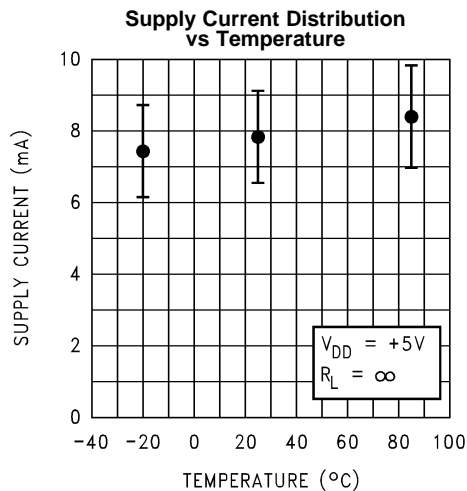

Figure 15.

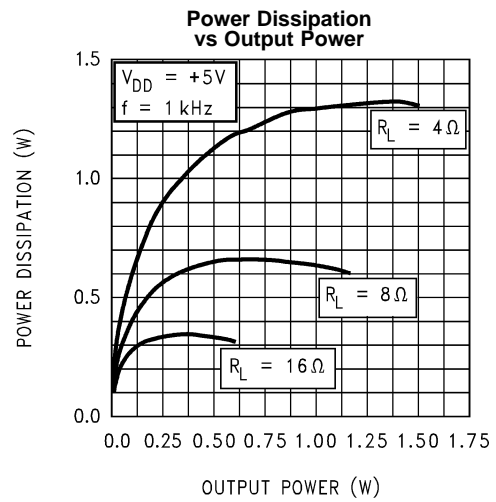

Figure 16.

Typical Performance Characteristics (continued)

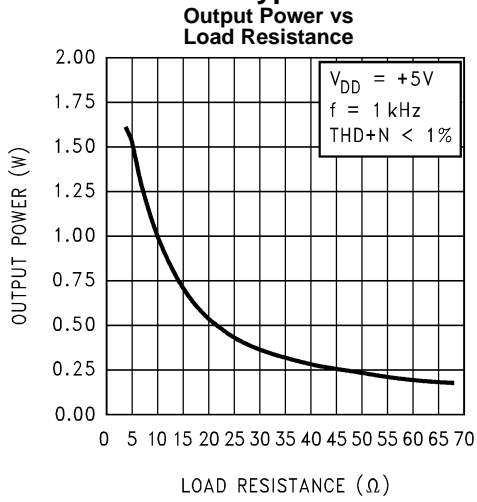

Figure 17.

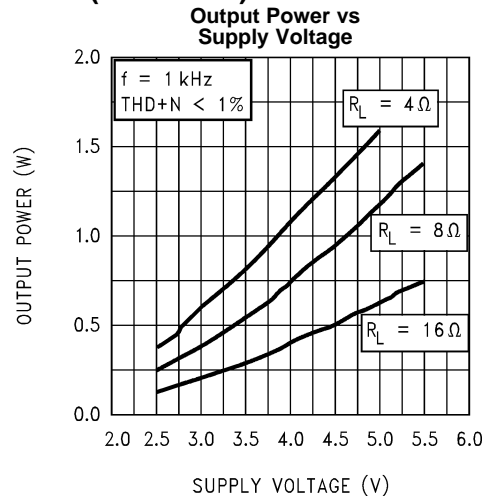

Figure 18.

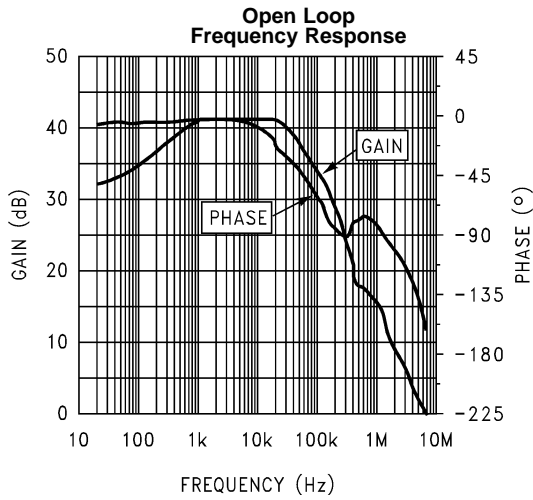

Figure 19.

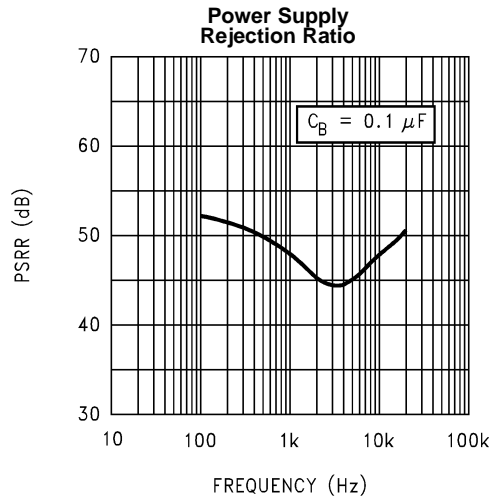

Figure 20.

APPLICATION INFORMATION

BRIDGE CONFIGURATION EXPLANATION

As shown in [Figure 1](#), the LM4860 has two operational amplifiers internally, allowing for a few different amplifier configurations. The first amplifier's gain is externally configurable, while the second amplifier is internally fixed in a unity-gain, inverting configuration. The closed-loop gain of the first amplifier is set by selecting the ratio of R_f to R_i while the second amplifier's gain is fixed by the two internal 40 k Ω resistors. [Figure 1](#) shows that the output of amplifier one serves as the input to amplifier two which results in both amplifiers producing signals identical in magnitude, but out of phase 180°. Consequently, the differential gain for the IC is:

$$A_{vd} = 2 * (R_f/R_i) \quad (1)$$

By driving the load differentially through outputs V_{O1} and V_{O2} , an amplifier configuration commonly referred to as "bridged mode" is established. Bridged mode operation is different from the classical single-ended amplifier configuration where one side of its load is connected to ground.

A bridge amplifier design has a few distinct advantages over the single-ended configuration, as it provides differential drive to the load, thus doubling output swing for a specified supply voltage. Consequently, four times the output power is possible as compared to a single-ended amplifier under the same conditions. This increase in attainable output power assumes that the amplifier is not current limited or clipped. In order to choose an amplifier's closed-loop gain without causing excessive clipping which will damage high frequency transducers used in loudspeaker systems, please refer to [AUDIO POWER AMPLIFIER DESIGN](#).

A bridge configuration, such as the one used in Boomer Audio Power Amplifiers, also creates a second advantage over single-ended amplifiers. Since the differential outputs, V_{O1} and V_{O2} , are biased at half-supply, no net DC voltage exists across the load. This eliminates the need for an output coupling capacitor which is required in a single supply, single-ended amplifier configuration. Without an output coupling capacitor in a single supply single-ended amplifier, the half-supply bias across the load would result in both increased internal IC power dissipation and also permanent loudspeaker damage. An output coupling capacitor forms a high pass filter with the load requiring that a large value such as 470 μ F be used with an 8 Ω load to preserve low frequency response. This combination does not produce a flat response down to 20 Hz, but does offer a compromise between printed circuit board size and system cost, versus low frequency response.

POWER DISSIPATION

Power dissipation is a major concern when designing a successful amplifier, whether the amplifier is bridged or single-ended. A direct consequence of the increased power delivered to the load by a bridge amplifier is an increase in internal power dissipation. [Equation 2](#) states the maximum power dissipation point for a bridge amplifier operating at a given supply voltage and driving a specified output load.

$$P_{DMAX} = 4 * (V_{DD})^2 / (2\pi^2 R_L) \quad (2)$$

Since the LM4860 has two operational amplifiers in one package, the maximum internal power dissipation is 4 times that of a single-ended amplifier. Even with this substantial increase in power dissipation, the LM4860 does not require heatsinking. From [Equation 2](#), assuming a 5V power supply and an 8 Ω load, the maximum power dissipation point is 625 mW. The maximum power dissipation point obtained from [Equation 2](#) must not be greater than the power dissipation that results from [Equation 3](#):

$$P_{DMAX} = (T_{JMAX} - T_A) / \theta_{JA} \quad (3)$$

For the LM4860 surface mount package, $\theta_{JA} = 100^\circ\text{C/W}$ and $T_{JMAX} = 150^\circ\text{C}$. Depending on the ambient temperature, T_A , of the system surroundings, [Equation 3](#) can be used to find the maximum internal power dissipation supported by the IC packaging. If the result of [Equation 2](#) is greater than that of [Equation 3](#), then either the supply voltage must be decreased or the load impedance increased. For the typical application of a 5V power supply, with an 8 Ω load, the maximum ambient temperature possible without violating the maximum junction temperature is approximately 88°C, provided that device operation is around the maximum power dissipation point. Power dissipation is a function of output power and thus, if typical operation is not around the maximum power dissipation point, the ambient temperature can be increased. Refer to [Typical Performance Characteristics](#) for power dissipation information for lower output powers.

POWER SUPPLY BYPASSING

As with any power amplifier, proper supply bypassing is critical for low noise performance and high power supply rejection. The capacitor location on both the bypass and power supply pins should be as close to the device as possible. As displayed in [Typical Performance Characteristics](#), the effect of a larger half-supply bypass capacitor is improved low frequency THD+N due to increased half-supply stability. Typical applications employ a 5V regulator with 10 μF and a 0.1 μF bypass capacitors which aid in supply stability, but do not eliminate the need for bypassing the supply nodes of the LM4860. The selection of bypass capacitors, especially C_B , is thus dependant upon desired low frequency THD+N, system cost, and size constraints.

SHUTDOWN FUNCTION

In order to reduce power consumption while not in use, the LM4860 contains a shutdown pin to externally turn off the amplifier's bias circuitry. The shutdown feature turns the amplifier off when a logic high is placed on the shutdown pin. Upon going into shutdown, the output is immediately disconnected from the speaker. There is a built-in threshold which produces a drop in quiescent current to 500 μA typically. For a 5V power supply, this threshold occurs when 2V–3V is applied to the shutdown pin. A typical quiescent current of 0.6 μA results when the supply voltage is applied to the shutdown pin. In many applications, a microcontroller or microprocessor output is used to control the shutdown circuitry which provides a quick, smooth transition into shutdown. Another solution is to use a single-pole, single-throw switch that when closed, is connected to ground and enables the amplifier. If the switch is open, then a soft pull-up resistor of 47 k Ω will disable the LM4860. There are no soft pull-down resistors inside the LM4860, so a definite shutdown pin voltage must be applied externally, or the internal logic gate will be left floating which could disable the amplifier unexpectedly.

HEADPHONE CONTROL INPUTS

The LM4860 possesses two headphone control inputs that disable the amplifier and reduce I_{DD} to less than 1 mA when either one or both of these inputs have a logic-high voltage placed on their pins.

Unlike the shutdown function, the headphone control function does not provide the level of current conservation that is required for battery powered systems. Since the quiescent current resulting from the headphone control function is 1000 times more than the shutdown function, the residual currents in the device may create a pop at the output when coming out of the headphone control mode. The pop effect may be eliminated by connecting the headphone sensing output to the shutdown pin input as shown in [Figure 21](#). This solution will not only eliminate the output pop, but will also utilize the full current conservation of the shutdown function by reducing I_{DD} to 0.6 μA . The amplifier will then be fully shutdown. This configuration also allows the designer to use the control inputs as either two headphone control pins or a headphone control pin and a shutdown pin where the lowest level of current consumption is obtained from either function.

[Figure 22](#) shows the implementation of the LM4860's headphone control function using a single-supply headphone amplifier. The voltage divider of R1 and R2 sets the voltage at the HP-IN1 pin to be approximately 50 mV when there are no headphones plugged into the system. This logic-low voltage at the HP-IN1 pin enables the LM4860 to amplify AC signals. Resistor R3 limits the amount of current flowing out of the HP-IN1 pin when the voltage at that pin goes below ground resulting from the music coming from the headphone amplifier. The output coupling cap protects the headphones by blocking the amplifier's half-supply DC voltage. The capacitor also protects the headphone amplifier from the low voltage set up by resistors R1 and R2 when there aren't any headphones plugged into the system. The tricky point to this setup is that the AC output voltage of the headphone amplifier cannot exceed the 2.0V HP-IN1 voltage threshold when there aren't any headphones plugged into the system, assuming that R1 and R2 are 100k and 1k, respectively. The LM4860 may not be fully shutdown when this level is exceeded momentarily, due to the discharging time constant of the bias-pin voltage. This time constant is established by the two 50k resistors (in parallel) with the series bypass capacitor value.

When a set of headphones are plugged into the system, the contact pin of the headphone jack is disconnected from the signal pin, interrupting the voltage divider set up by resistors R1 and R2. Resistor R1 then pulls up the HP-IN1 pin, enabling the headphone function and disabling the LM4860 amplifier. The headphone amplifier then drives the headphones, whose impedance is in parallel with resistor R2. Since the typical impedance of headphones are 32 Ω , resistor R2 has negligible effect on the output drive capability. Also shown in [Figure 22](#) are the electrical connections for the headphone jack and plug. A 3-wire plug consists of a Tip, Ring, and Sleeve, where the Tip and Ring are signal carrying conductors and the Sleeve is the common ground return. One control pin contact for each headphone jack is sufficient to indicate to control inputs that the user has inserted a plug into a jack and that another mode of operation is desired.

HIGHER GAIN AUDIO AMPLIFIER

The LM4860 is unity-gain stable and requires no external components besides gain-setting resistors, an input coupling capacitor, and proper supply bypassing in the typical application. However if a closed-loop differential gain of greater than 10 is required, then a feedback capacitor is needed, as shown in [Figure 3](#), to bandwidth limit the amplifier. The feedback capacitor creates a low pass filter that eliminates unwanted high frequency oscillations. Care should be taken when calculating the -3 dB frequency in that an incorrect combination of R_f and C_f will cause rolloff before 20 kHz. A typical combination of feedback resistor and capacitor that will not produce audio band high frequency rolloff is $R_f = 100$ k Ω and $C_f = 5$ pF. These components result in a -3 dB point of approximately 320 kHz. Once the differential gain of the amplifier has been calculated, a choice of R_f will result, and C_f can then be calculated from the formula stated in [External Components Description](#).

VOICE-BAND AUDIO AMPLIFIER

Many applications, such as telephony, only require a voice-band frequency response. Such an application usually requires a flat frequency response from 300 Hz to 3.5 kHz. By adjusting the component values of [Figure 3](#), this common application requirement can be implemented. The combination of R_i and C_i form a highpass filter while R_f and C_f form a lowpass filter. Using the typical voice-band frequency range, with a passband differential gain of approximately 100, the following values of R_i , C_i , R_f , and C_f follow from the equations stated in [External Components Description](#).

$$R_i = 10 \text{ k}\Omega, R_f = 510 \text{ k}\Omega, C_i = 0.22 \text{ }\mu\text{F}, \text{ and } C_f = 15 \text{ pF} \quad (4)$$

Five times away from a -3 dB point is 0.17 dB down from the flatband response. With this selection of components, the resulting -3 dB points, f_L and f_H , are 72 Hz and 20 kHz, respectively, resulting in a flatband frequency response of better than ± 0.25 dB with a rolloff of 6 dB/octave outside of the passband. If a steeper rolloff is required, other common bandpass filtering techniques can be used to achieve higher order filters.

SINGLE-ENDED AUDIO AMPLIFIER

Although the typical application for the LM4860 is a bridged monoaural amp, it can also be used to drive a load single-endedly in applications, such as PC cards, which require that one side of the load is tied to ground. [Figure 4](#) shows a common single-ended application, where V_{O1} is used to drive the speaker. This output is coupled through a 470 μF capacitor, which blocks the half-supply DC bias that exists in all single-supply amplifier configurations. This capacitor, designated C_O in [Figure 4](#), in conjunction with R_L , forms a highpass filter. The -3 dB point of this highpass filter is $1/(2\pi R_L C_O)$, so care should be taken to make sure that the product of R_L and C_O is large enough to pass low frequencies to the load. When driving an 8 Ω load, and if a full audio spectrum reproduction is required, C_O should be at least 470 μF . V_{O2} , the output that is not used, is connected through a 0.1 μF capacitor to a 2 k Ω load to prevent instability. While such an instability will not affect the waveform of V_{O1} , it is good design practice to load the second output.

AUDIO POWER AMPLIFIER DESIGN

Design a 500 mW/8 Ω Audio Amplifier

Given:

Power Output: 500 mW_{rms}

Load Impedance: 8 Ω

Input Level: 1 V_{rms}(max)

Input Impedance: 20 k Ω

Bandwidth: 20 Hz-20 kHz ± 0.25 dB

A designer must first determine the needed supply rail to obtain the specified output power. Calculating the required supply rail involves knowing two parameters, V_{opeak} and also the dropout voltage. The latter is typically 0.7V. V_{opeak} can be determined from [Equation 5](#).

$$V_{\text{opeak}} = \sqrt{2 R_L P_O} \quad (5)$$

For 500 mW of output power into an 8Ω load, the required V_{opeak} is 2.83V. A minimum supply rail of 3.53V results from adding V_{opeak} and V_{od} . But 3.53V is not a standard voltage that exists in many applications and for this reason, a supply rail of 5V is designated. Extra supply voltage creates dynamic headroom that allows the LM4860 to reproduce peaks in excess of 500 mW without clipping the signal. At this time, the designer must make sure that the power supply choice along with the output impedance does not violate the conditions explained in [POWER DISSIPATION](#).

Once the power dissipation equations have been addressed, the required differential gain can be determined from [Equation 6](#).

$$A_{\text{vd}} \geq 2 * \sqrt{(P_{\text{O}} R_{\text{L}})} / (V_{\text{IN}}) = V_{\text{orms}} / V_{\text{inrms}} \quad (6)$$

From [Equation 6](#), the minimum A_{vd} is: $A_{\text{vd}} = 2$

Since the desired input impedance was 20 kΩ, and with an A_{vd} of 2, a ratio of 1:1 of R_{f} to R_{i} results in an allocation of $R_{\text{i}} = R_{\text{f}} = 20 \text{ k}\Omega$. Since the A_{vd} was less than 10, a feedback capacitor is not needed. The final design step is to address the bandwidth requirements which must be stated as a pair of -3 dB frequency points. Five times away from a -3 dB point is 0.17 dB down from passband response which is better than the required ±0.25 dB specified. This fact results in a low and high frequency pole of 4 Hz and 100 kHz respectively. As stated in [External Components Description](#), R_{i} in conjunction with C_{i} create a highpass filter.

$$C_{\text{i}} \geq 1/(2\pi * 20 \text{ k}\Omega * 4 \text{ Hz}) = 1.98 \mu\text{F}; \text{ use } 2.2 \mu\text{F}. \quad (7)$$

The high frequency pole is determined by the product of the desired high frequency pole, f_{H} , and the differential gain, A_{vd} . With a $A_{\text{vd}} = 2$ and $f_{\text{H}} = 100 \text{ kHz}$, the resulting GBWP = 100 kHz which is much smaller than the LM4860 GBWP of 7 MHz. This figure displays that if a designer has a need to design an amplifier with a higher differential gain, the LM4860 can still be used without running into bandwidth problems.

REVISION HISTORY

Changes from Revision B (May 2013) to Revision C	Page
• Changed layout of National Data Sheet to TI format	13

PACKAGING INFORMATION

Orderable Device	Status (1)	Package Type	Package Drawing	Pins	Package Qty	Eco Plan (2)	Lead/Ball Finish (6)	MSL Peak Temp (3)	Op Temp (°C)	Device Marking (4/5)	Samples
LM4860M	ACTIVE	SOIC	D	16	48	TBD	Call TI	Call TI	-20 to 85	LM4860M	Samples
LM4860M/NOPB	ACTIVE	SOIC	D	16	48	Green (RoHS & no Sb/Br)	CU SN	Level-1-260C-UNLIM	-20 to 85	LM4860M	Samples
LM4860MX/NOPB	ACTIVE	SOIC	D	16	2500	Green (RoHS & no Sb/Br)	CU SN	Level-1-260C-UNLIM	-20 to 85	LM4860M	Samples

(1) The marketing status values are defined as follows:

ACTIVE: Product device recommended for new designs.

LIFEBUY: TI has announced that the device will be discontinued, and a lifetime-buy period is in effect.

NRND: Not recommended for new designs. Device is in production to support existing customers, but TI does not recommend using this part in a new design.

PREVIEW: Device has been announced but is not in production. Samples may or may not be available.

OBSELETE: TI has discontinued the production of the device.

(2) **RoHS:** TI defines "RoHS" to mean semiconductor products that are compliant with the current EU RoHS requirements for all 10 RoHS substances, including the requirement that RoHS substance do not exceed 0.1% by weight in homogeneous materials. Where designed to be soldered at high temperatures, "RoHS" products are suitable for use in specified lead-free processes. TI may reference these types of products as "Pb-Free".

RoHS Exempt: TI defines "RoHS Exempt" to mean products that contain lead but are compliant with EU RoHS pursuant to a specific EU RoHS exemption.

Green: TI defines "Green" to mean the content of Chlorine (Cl) and Bromine (Br) based flame retardants meet JS709B low halogen requirements of <=1000ppm threshold. Antimony trioxide based flame retardants must also meet the <=1000ppm threshold requirement.

(3) MSL, Peak Temp. - The Moisture Sensitivity Level rating according to the JEDEC industry standard classifications, and peak solder temperature.

(4) There may be additional marking, which relates to the logo, the lot trace code information, or the environmental category on the device.

(5) Multiple Device Markings will be inside parentheses. Only one Device Marking contained in parentheses and separated by a "~" will appear on a device. If a line is indented then it is a continuation of the previous line and the two combined represent the entire Device Marking for that device.

(6) Lead/Ball Finish - Orderable Devices may have multiple material finish options. Finish options are separated by a vertical ruled line. Lead/Ball Finish values may wrap to two lines if the finish value exceeds the maximum column width.

Important Information and Disclaimer:The information provided on this page represents TI's knowledge and belief as of the date that it is provided. TI bases its knowledge and belief on information provided by third parties, and makes no representation or warranty as to the accuracy of such information. Efforts are underway to better integrate information from third parties. TI has taken and continues to take reasonable steps to provide representative and accurate information but may not have conducted destructive testing or chemical analysis on incoming materials and chemicals. TI and TI suppliers consider certain information to be proprietary, and thus CAS numbers and other limited information may not be available for release.

In no event shall TI's liability arising out of such information exceed the total purchase price of the TI part(s) at issue in this document sold by TI to Customer on an annual basis.

TAPE AND REEL INFORMATION



QUADRANT ASSIGNMENTS FOR PIN 1 ORIENTATION IN TAPE



*All dimensions are nominal

Device	Package Type	Package Drawing	Pins	SPQ	Reel Diameter (mm)	Reel Width W1 (mm)	A0 (mm)	B0 (mm)	K0 (mm)	P1 (mm)	W (mm)	Pin1 Quadrant
LM4860MX/NOPB	SOIC	D	16	2500	330.0	16.4	6.5	10.3	2.3	8.0	16.0	Q1

TAPE AND REEL BOX DIMENSIONS

*All dimensions are nominal

Device	Package Type	Package Drawing	Pins	SPQ	Length (mm)	Width (mm)	Height (mm)
LM4860MX/NOPB	SOIC	D	16	2500	367.0	367.0	35.0

D (R-PDSO-G16)

PLASTIC SMALL OUTLINE



4040047-6/M 06/11

- NOTES:
- A. All linear dimensions are in inches (millimeters).
 - B. This drawing is subject to change without notice.
 -  C. Body length does not include mold flash, protrusions, or gate burrs. Mold flash, protrusions, or gate burrs shall not exceed 0.006 (0,15) each side.
 -  D. Body width does not include interlead flash. Interlead flash shall not exceed 0.017 (0,43) each side.
 - E. Reference JEDEC MS-012 variation AC.

IMPORTANT NOTICE

Texas Instruments Incorporated (TI) reserves the right to make corrections, enhancements, improvements and other changes to its semiconductor products and services per JESD46, latest issue, and to discontinue any product or service per JESD48, latest issue. Buyers should obtain the latest relevant information before placing orders and should verify that such information is current and complete.

TI's published terms of sale for semiconductor products (<http://www.ti.com/sc/docs/stdterms.htm>) apply to the sale of packaged integrated circuit products that TI has qualified and released to market. Additional terms may apply to the use or sale of other types of TI products and services.

Reproduction of significant portions of TI information in TI data sheets is permissible only if reproduction is without alteration and is accompanied by all associated warranties, conditions, limitations, and notices. TI is not responsible or liable for such reproduced documentation. Information of third parties may be subject to additional restrictions. Resale of TI products or services with statements different from or beyond the parameters stated by TI for that product or service voids all express and any implied warranties for the associated TI product or service and is an unfair and deceptive business practice. TI is not responsible or liable for any such statements.

Buyers and others who are developing systems that incorporate TI products (collectively, "Designers") understand and agree that Designers remain responsible for using their independent analysis, evaluation and judgment in designing their applications and that Designers have full and exclusive responsibility to assure the safety of Designers' applications and compliance of their applications (and of all TI products used in or for Designers' applications) with all applicable regulations, laws and other applicable requirements. Designer represents that, with respect to their applications, Designer has all the necessary expertise to create and implement safeguards that (1) anticipate dangerous consequences of failures, (2) monitor failures and their consequences, and (3) lessen the likelihood of failures that might cause harm and take appropriate actions. Designer agrees that prior to using or distributing any applications that include TI products, Designer will thoroughly test such applications and the functionality of such TI products as used in such applications.

TI's provision of technical, application or other design advice, quality characterization, reliability data or other services or information, including, but not limited to, reference designs and materials relating to evaluation modules, (collectively, "TI Resources") are intended to assist designers who are developing applications that incorporate TI products; by downloading, accessing or using TI Resources in any way, Designer (individually or, if Designer is acting on behalf of a company, Designer's company) agrees to use any particular TI Resource solely for this purpose and subject to the terms of this Notice.

TI's provision of TI Resources does not expand or otherwise alter TI's applicable published warranties or warranty disclaimers for TI products, and no additional obligations or liabilities arise from TI providing such TI Resources. TI reserves the right to make corrections, enhancements, improvements and other changes to its TI Resources. TI has not conducted any testing other than that specifically described in the published documentation for a particular TI Resource.

Designer is authorized to use, copy and modify any individual TI Resource only in connection with the development of applications that include the TI product(s) identified in such TI Resource. NO OTHER LICENSE, EXPRESS OR IMPLIED, BY ESTOPPEL OR OTHERWISE TO ANY OTHER TI INTELLECTUAL PROPERTY RIGHT, AND NO LICENSE TO ANY TECHNOLOGY OR INTELLECTUAL PROPERTY RIGHT OF TI OR ANY THIRD PARTY IS GRANTED HEREIN, including but not limited to any patent right, copyright, mask work right, or other intellectual property right relating to any combination, machine, or process in which TI products or services are used. Information regarding or referencing third-party products or services does not constitute a license to use such products or services, or a warranty or endorsement thereof. Use of TI Resources may require a license from a third party under the patents or other intellectual property of the third party, or a license from TI under the patents or other intellectual property of TI.

TI RESOURCES ARE PROVIDED "AS IS" AND WITH ALL FAULTS. TI DISCLAIMS ALL OTHER WARRANTIES OR REPRESENTATIONS, EXPRESS OR IMPLIED, REGARDING RESOURCES OR USE THEREOF, INCLUDING BUT NOT LIMITED TO ACCURACY OR COMPLETENESS, TITLE, ANY EPIDEMIC FAILURE WARRANTY AND ANY IMPLIED WARRANTIES OF MERCHANTABILITY, FITNESS FOR A PARTICULAR PURPOSE, AND NON-INFRINGEMENT OF ANY THIRD PARTY INTELLECTUAL PROPERTY RIGHTS. TI SHALL NOT BE LIABLE FOR AND SHALL NOT DEFEND OR INDEMNIFY DESIGNER AGAINST ANY CLAIM, INCLUDING BUT NOT LIMITED TO ANY INFRINGEMENT CLAIM THAT RELATES TO OR IS BASED ON ANY COMBINATION OF PRODUCTS EVEN IF DESCRIBED IN TI RESOURCES OR OTHERWISE. IN NO EVENT SHALL TI BE LIABLE FOR ANY ACTUAL, DIRECT, SPECIAL, COLLATERAL, INDIRECT, PUNITIVE, INCIDENTAL, CONSEQUENTIAL OR EXEMPLARY DAMAGES IN CONNECTION WITH OR ARISING OUT OF TI RESOURCES OR USE THEREOF, AND REGARDLESS OF WHETHER TI HAS BEEN ADVISED OF THE POSSIBILITY OF SUCH DAMAGES.

Unless TI has explicitly designated an individual product as meeting the requirements of a particular industry standard (e.g., ISO/TS 16949 and ISO 26262), TI is not responsible for any failure to meet such industry standard requirements.



Where TI specifically promotes products as facilitating functional safety or as compliant with industry functional safety standards, such products are intended to help enable customers to design and create their own applications that meet applicable functional safety standards and requirements. Using products in an application does not by itself establish any safety features in the application. Designers must ensure compliance with safety-related requirements and standards applicable to their applications. Designer may not use any TI products in life-critical medical equipment unless authorized officers of the parties have executed a special contract specifically governing such use. Life-critical medical equipment is medical equipment where failure of such equipment would cause serious bodily injury or death (e.g., life support, pacemakers, defibrillators, heart pumps, neurostimulators, and implantables). Such equipment includes, without limitation, all medical devices identified by the U.S. Food and Drug Administration as Class III devices and equivalent classifications outside the U.S.

TI may expressly designate certain products as completing a particular qualification (e.g., Q100, Military Grade, or Enhanced Product). Designers agree that it has the necessary expertise to select the product with the appropriate qualification designation for their applications and that proper product selection is at Designers' own risk. Designers are solely responsible for compliance with all legal and regulatory requirements in connection with such selection.

Designer will fully indemnify TI and its representatives against any damages, costs, losses, and/or liabilities arising out of Designer's non-compliance with the terms and provisions of this Notice.

Looking for pricing, stock, or lifecycle information?

Click below to explore more details on WIN SOURCE:

-  [View LM4860MX](#) on WIN SOURCE
-  [Texas Instruments](#) Information

Optimize Your Supply Chain with WIN SOURCE Solutions

-  Global Sourcing Solution
-  Obsolete Management
-  Cost Control Management
-  Shortage Management
-  Alternative Solution
-  Excess Inventory Management