



THE DATASHEET OF LM4851ITLX



LM4851 Boomer® Audio Power Amplifier Series Integrated Audio Amplifier System

Check for Samples: [LM4851](#)

FEATURES

- Mono 1.1W (typ) and Stereo 115mW (typ) Output
- SPI Programmable 32 Step Digital Volume Control (-40.5dB to +6dB)
- Eight Distinct SPI Programmable Output Modes
- Micro-SMD and LLP Surface Mount Packaging
- “Click and pop” Suppression Circuitry
- Thermal Shutdown Protection
- Low Shutdown Current (0.1µA, typ)

APPLICATIONS

- Mobile Phones
- PDAs

KEY SPECIFICATIONS

- THD+N at 1kHz, 1.5W into 4Ω BTL (LQ): 1% (typ)
- THD+N at 1kHz, 1.1W into 8Ω BTL: 1% (typ)
- THD+N at 1kHz, 115mW into 32Ω BTL: 0.5% (typ)
- Single Supply Operation: 2.6 to 5.0V

DESCRIPTION

The LM4851 is an audio power amplifier system capable of delivering 1.1W (typ) of continuous average power into a mono 8Ω bridged-tied load (BTL) with 1% THD+N and 115mW (typ) per channel of continuous average power into stereo 32Ω BTL loads with 0.5% THD+N, using a 5V power supply.

The LM4851 features a 32 step digital volume control and eight distinct output modes. The digital volume control and output modes are programmed through a three-wire SPI serial control interface, that allows flexibility in routing and mixing audio channels. The LM4851 has 3 inputs: one pair for a two-channel stereo signal and the third for a single-channel mono input.

The LM4851 is designed for cellular phone, PDA, and other portable handheld applications. It delivers high quality output power from a surface-mount package and requires only five external components.

The industry leading micro SMD package utilizes only 2mm x 2.3mm of PCB space, making the LM4851 the most space efficient audio sub system available today.



Please be aware that an important notice concerning availability, standard warranty, and use in critical applications of Texas Instruments semiconductor products and disclaimers thereto appears at the end of this data sheet.

All trademarks are the property of their respective owners.

Typical Application

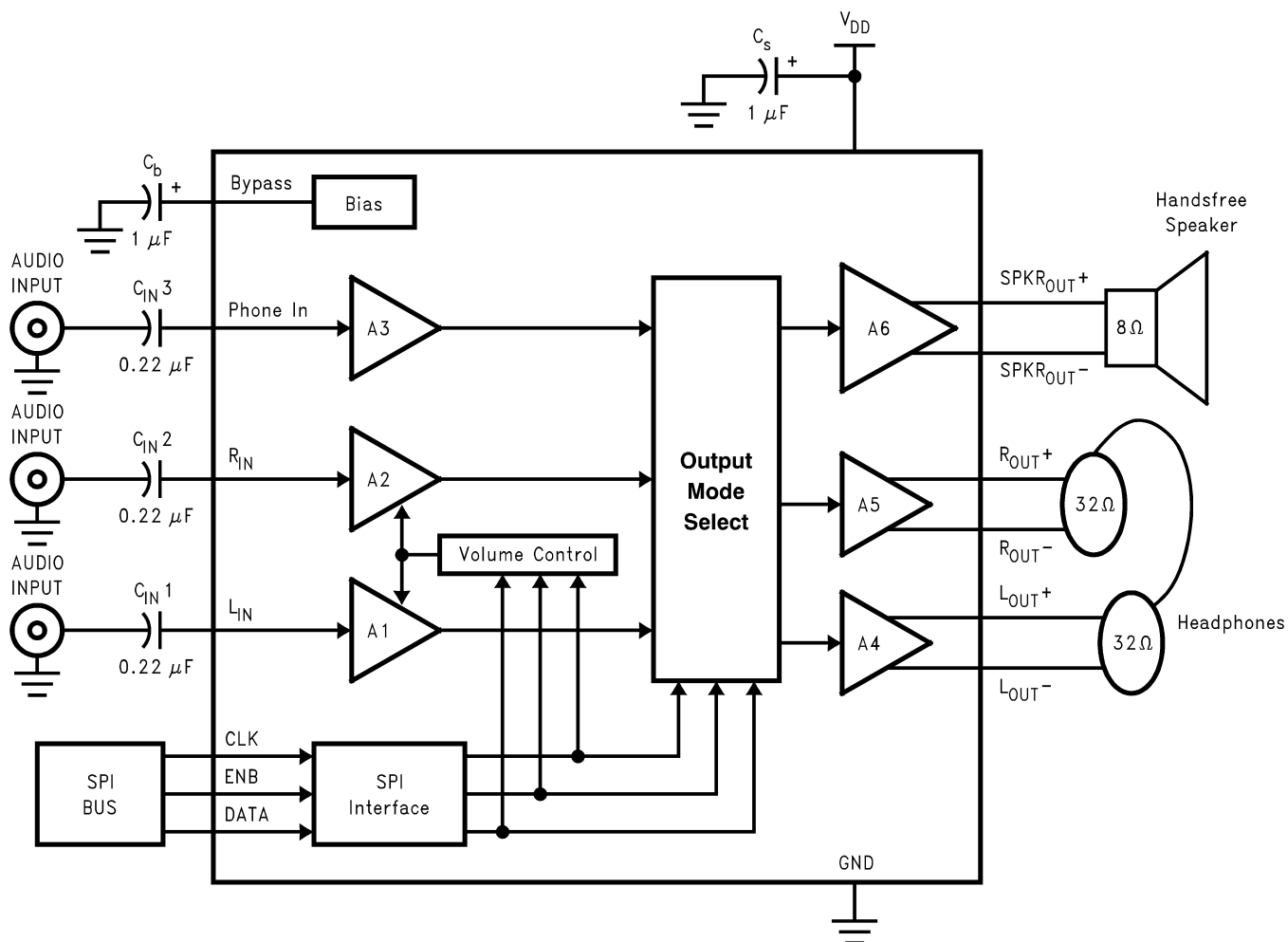
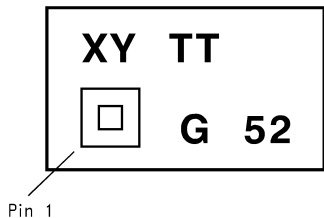
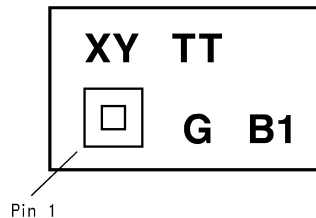

Figure 1. Typical Audio Amplifier Application Circuit

Connection Diagrams



**Figure 2. 18-Bump micro SMD Marking (IBL)
(Top View)**
XY- Date Code
TT - Die Traceability
G - Boomer Family
52 - LM4851IBL-1



**Figure 3. 18-Bump micro SMD Marking (ITL)
(Top View)**
XY- Date Code
TT - Die Traceability
G - Boomer Family
B1 - LM4851ITL

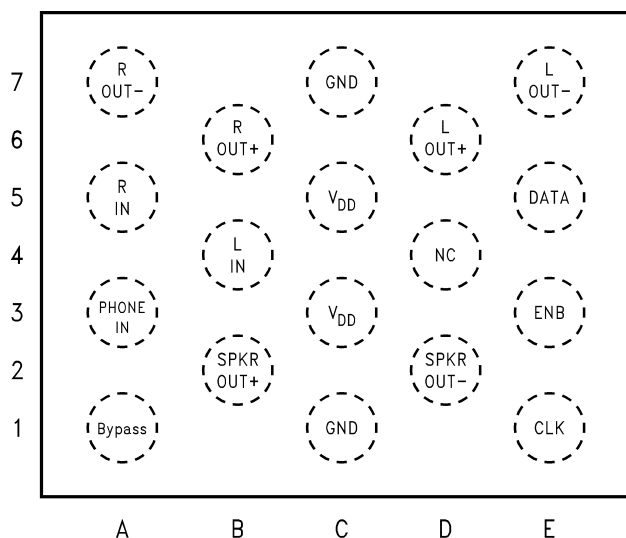

**Figure 4. NC = NO CONNECT
Top View (Bump-side down)**
See Package Number TLA18AAA, BLA18AAB

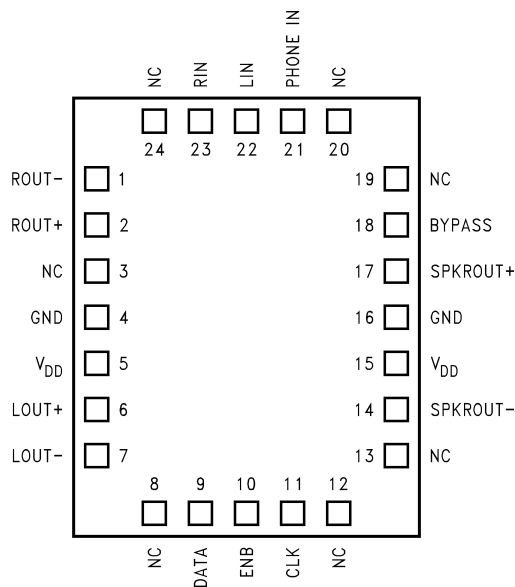

**Figure 5. Top View
See Package Number LQA24A
for Exposed-DAP LLP**



These devices have limited built-in ESD protection. The leads should be shorted together or the device placed in conductive foam during storage or handling to prevent electrostatic damage to the MOS gates.

Absolute Maximum Ratings⁽¹⁾⁽²⁾

Supply Voltage		6.0V
Storage Temperature		-65°C to +150°C
ESD Susceptibility ⁽³⁾		2.0kV
ESD Machine model ⁽⁴⁾		200V
Junction Temperature (T _J)		150°C
Solder Information	Vapor Phase (60 sec.)	215°C
	Infrared (15 sec.)	220°C
Thermal Resistance	θ _{JA} (typ) - LQA24A	42°C/W
	θ _{JC} (typ) - LQA24A	3.0°C/W
	θ _{JA} (typ) - BLA18AAB	48°C/W ⁽⁵⁾
	θ _{JC} (typ) - BLA18AAB	23°C/W ⁽⁵⁾
	θ _{JA} (typ) - TLA18AAA	48°C/W ⁽⁵⁾
	θ _{JC} (typ) - TLA18AAA	23°C/W ⁽⁵⁾

- (1) Absolute Maximum Rating indicate limits beyond which damage to the device may occur.
- (2) If Military/Aerospace specified devices are required, please contact the TI Sales Office/ Distributors for availability and specifications.
- (3) Human body model, 100pF discharged through a 1.5kΩ resistor.
- (4) Machine Model ESD test is covered by specification EIAJ IC-121-1981. A 200pF cap is charged to the specified voltage, then discharged directly into the IC with no external series resistor (resistance of discharge path must be under 50Ω).
- (5) The given θ_{JA} and θ_{JC} is for an LM4851 mounted on a demonstration board with a 4 in² area of 1oz printed circuit board copper ground plane.

Operating Ratings⁽¹⁾

Temperature Range	-40°C to 85°C
Supply Voltage V _{DD}	2.6V ≤ V _{DD} ≤ 5.0V

- (1) Operating Ratings indicate conditions for which the device is functional, but do not ensure specific performance limits. For ensured specifications and test conditions, see the [Electrical Characteristics](#). The ensured specifications apply only for the test conditions listed. Some performance characteristics may degrade when the device is not operated under the listed test conditions.

Electrical Characteristics⁽¹⁾⁽²⁾

The following specifications apply for V_{DD} = 5.0V, T_A = 25°C unless otherwise specified.

Symbol	Parameter	Conditions	LM4851		Units (Limits)
			Typical ⁽³⁾	Limit ⁽⁴⁾	
I _{DD}	Supply Current	Output mode 7 V _{IN} = 0V; I _O = 0A	7.5	14	mA (max)
		Output modes 1, 2, 3, 4, 5, 6 V _{IN} = 0V; I _O = 0A	5.0	9.0	mA (max)
I _{DD}	Shutdown Current	Output mode 0	0.1	2	μA (max)
V _{OS}	Output Offset Voltage	V _{IN} = 0V	5.0	50	mV (max)
P _O	Output Power	SPKR _{OUT} ; R _L = 4Ω THD+N = 1%; f = 1kHz LM4851LQ	1.5		W
		SPKR _{OUT} ; R _L = 8Ω THD+N = 1%; f = 1kHz	1.1	0.8	W (min)
		R _{OUT} and L _{OUT} ; R _L = 32Ω THD+N = 0.5%; f = 1kHz	115	80	mW (min)

- (1) Absolute Maximum Rating indicate limits beyond which damage to the device may occur.
- (2) All voltages are measured with respect to the ground pin, unless otherwise specified.
- (3) Typical specifications are specified at +25°C and represent the most likely parametric norm.
- (4) Datasheet min/max specification limits are ensured by design, test, or statistical analysis.

Electrical Characteristics⁽¹⁾⁽²⁾ (continued)

The following specifications apply for $V_{DD} = 5.0V$, $T_A = 25^\circ C$ unless otherwise specified.

Symbol	Parameter	Conditions	LM4851		Units (Limits)
			Typical ⁽³⁾	Limit ⁽⁴⁾	
THD+N	Total Harmonic Distortion Plus Noise	R_{OUT} and L_{OUT} ; $f = 1kHz$ $P_{OUT} = 80mW$; $R_L = 32\Omega$		0.5	% (max)
		SPKR _{OUT} ; $f = 1kHz$ $P_{OUT} = 800mW$; $R_L = 8\Omega$		1.0	% (max)
		R_{OUT} and L_{OUT} ; $f = 20Hz$ to $20kHz$ $P_{OUT} = 100mW$; $R_L = 32\Omega$	0.3		%
		SPKR _{OUT} ; $f = 20Hz$ to $20kHz$ $P_{OUT} = 1W$; $R_L = 4\Omega$ LM4851LQ	0.3		%
		SPKR _{OUT} ; $f = 20Hz$ to $20kHz$ $P_{OUT} = 800mW$; $R_L = 8\Omega$	0.3		%
N_{OUT}	Output Noise	A-weighted ⁽⁵⁾	29		μV
PSRR	Power Supply Rejection Ratio	$V_{RIPPLE} = 200mV_{PP}$; $f = 217Hz$ Input floating; Input referred	70		dB
		$V_{RIPPLE} = 200mV_{PP}$; $f = 217Hz$ Input terminated into 50Ω ; Output referred	62		dB
V_{IH}	Logic High Input Voltage			1.4 5.0	V (min) V (max)
V_{IL}	Logic Low Input Voltage			0.4	V (max)
	Digital Volume Range (R_{IN} and L_{IN})	Input referred minimum gain Input referred maximum gain	-40.5 +6		dB
	Digital Volume Stepsize		1.5		dB
	Stepsize Error		± 0.5		dB
	Phone In Volume	BTL gain from Phone In to SPKR _{OUT}	6		dB
	Phone In Volume	BTL gain from Phone In to R_{OUT} , L_{OUT}	0		dB
	Phone In Input Impedance		20	15 25	k Ω (min) k Ω (max)
	R_{IN} and L_{IN}		50	37.5 62.5	k Ω (min) k Ω (max)
t_{ES}	Enable Setup Time (ENB)			20	ns (min)
t_{EH}	Enable Hold Time (ENB)			20	ns (min)
t_{EL}	Enable Low Time (ENB)			30	ns (min)
t_{DS}	Data Setup Time (DATA)			20	ns (min)
t_{DH}	Data Hold Time (DATA)			20	ns (min)
t_{CS}	Clock Setup Time (CLK)			20	ns (min)
t_{CH}	Clock Logic High Time (CLK)			50	ns (min)
t_{CL}	Clock Logic Low Time (CLK)			50	ns (min)
t_{CLK}	Clock Frequency			DC 10	(min) MHz (max)

(5) Please refer to the [Output Noise vs Output Mode](#) table in the [Typical Performance Characteristics](#) section for more details.

Electrical Characteristics⁽¹⁾⁽²⁾

The following specifications apply for $V_{DD} = 3.0V$, $T_A = 25^\circ C$ unless otherwise specified.

Symbol	Parameter	Conditions	LM4851		Units (Limits)
			Typical ⁽³⁾	Limit ⁽⁴⁾	
I_{DD}	Supply Current	Output mode 7 $V_{IN} = 0V$; $I_O = 0A$	6.2	11	mA (max)
		Output modes 1, 2, 3, 4, 5, 6 $V_{IN} = 0V$; $I_O = 0A$	4.0	7.0	mA (max)
I_{DD}	Shutdown Current	Output mode 0	0.1	2	μA (max)
V_{OS}	Output Offset Voltage	$V_{IN} = 0V$	5.0	50	mV (max)
P_O	Output Power	SPKR _{OUT} ; $R_L = 4\Omega$ THD+N = 1%; $f = 1kHz$ LM4851LQ	430		mW
		SPKR _{OUT} ; $R_L = 8\Omega$ THD+N = 1%; $f = 1kHz$	340	300	mW (min)
		R_{OUT} and L_{OUT} ; $R_L = 32\Omega$ THD+N = 0.5%; $f = 1kHz$	25	20	mW (min)
THD+N	Total Harmonic Distortion Plus Noise	R_{OUT} and L_{OUT} ; $f = 1kHz$ $P_{OUT} = 20mW$; $R_L = 32\Omega$		0.5	% (max)
		SPKR _{OUT} ; $f = 1kHz$ $P_{OUT} = 300mW$; $R_L = 8\Omega$		1.0	% (max)
		R_{OUT} and L_{OUT} ; $f = 20Hz$ to $20kHz$ $P_{OUT} = 20mW$; $R_L = 32\Omega$	0.4		%
		SPKR _{OUT} ; $f = 20Hz$ to $20kHz$ $P_{OUT} = 300mW$; $R_L = 4\Omega$ LM4851LQ	0.3		%
		SPKR _{OUT} ; $f = 20Hz$ to $20kHz$ $P_{OUT} = 250mW$; $R_L = 8\Omega$	0.3		%
N_{OUT}	Output Noise	A-weighted ⁽⁵⁾	29		μV
PSRR	Power Supply Rejection Ratio	$V_{RIPPLE} = 200mV_{PP}$; $f = 217Hz$ Input floating; Input referred	70		dB
		$V_{RIPPLE} = 200mV_{PP}$; $f = 217Hz$ Input terminated into 50Ω ; Output referred	62		dB
V_{IH}	Logic High Input Voltage			1.4 3.0	V (min) V (max)
V_{IL}	Logic Low Input Voltage			0.4	V (max)
	Digital Volume Range (R_{IN} and L_{IN})	Input referred minimum gain Input referred maximum gain	-40.5 +6		dB
	Digital Volume Stepsize		1.5		dB
	Stepsize Error		± 0.5		dB
	Phone In Volume	BTL gain from Phone In to SPKR _{OUT}	6		dB
	Phone In Volume	BTL gain from Phone In to R_{OUT}, L_{OUT}	0		dB
	Phone In Input Impedance		20	15 25	k Ω (min) k Ω (max)
	R_{IN} and L_{IN}		50	37.5 62.5	k Ω (min) k Ω (max)
t_{ES}	Enable Setup Time (ENB)			20	ns (min)
t_{EH}	Enable Hold Time (ENB)			20	ns (min)
t_{EL}	Enable Low Time (ENB)			30	ns (min)
t_{DS}	Data Setup Time (DATA)			20	ns (min)
t_{DH}	Data Hold Time (DATA)			20	ns (min)

(1) Absolute Maximum Rating indicate limits beyond which damage to the device may occur.

(2) All voltages are measured with respect to the ground pin, unless otherwise specified.

(3) Typical specifications are specified at $+25^\circ C$ and represent the most likely parametric norm.

(4) Datasheet min/max specification limits are ensured by design, test, or statistical analysis.

(5) Please refer to the [Output Noise vs Output Mode](#) table in the [Typical Performance Characteristics](#) section for more details.

Electrical Characteristics⁽¹⁾⁽²⁾ (continued)

 The following specifications apply for $V_{DD} = 3.0V$, $T_A = 25^\circ C$ unless otherwise specified.

Symbol	Parameter	Conditions	LM4851		Units (Limits)
			Typical ⁽³⁾	Limit ⁽⁴⁾	
t_{CS}	Clock Setup Time (CLK)			20	ns (min)
t_{CH}	Clock Logic High Time (CLK)			50	ns (min)
t_{CL}	Clock Logic Low Time (CLK)			50	ns (min)
t_{CLK}	Clock Frequency			DC 10	(min) MHz (max)

Table 1. External Components Description⁽¹⁾

Components		Functional Description
1.	C_{in}	This is the input coupling capacitor. It blocks the DC voltage at, and couples the the input signal to, the amplifier's input terminals. C_i , also creates a highpass filter with the internal resistor R_i at $f_c = 1/(2\pi R_i C_i)$.
2.	C_s	This is the supply bypass capacitor. It provides power supply filtering.
3.	C_B	This is the BYPASS pin capacitor. It provides half-supply filtering.

 (1) (see [Figure 1](#))

Typical Performance Characteristics

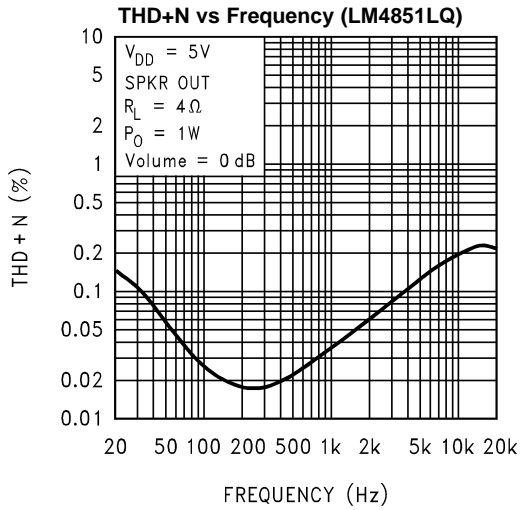

Figure 6.

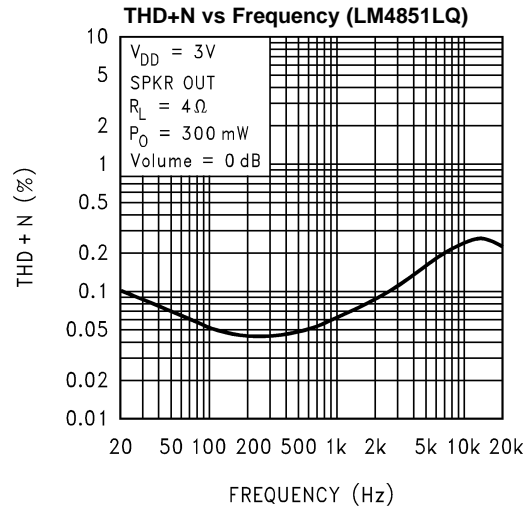

Figure 7.

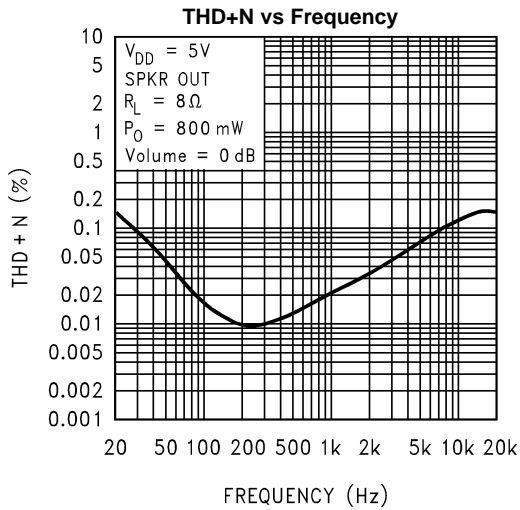

Figure 8.

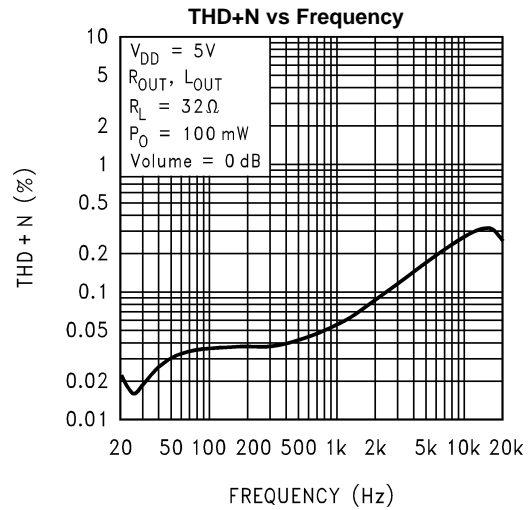

Figure 9.

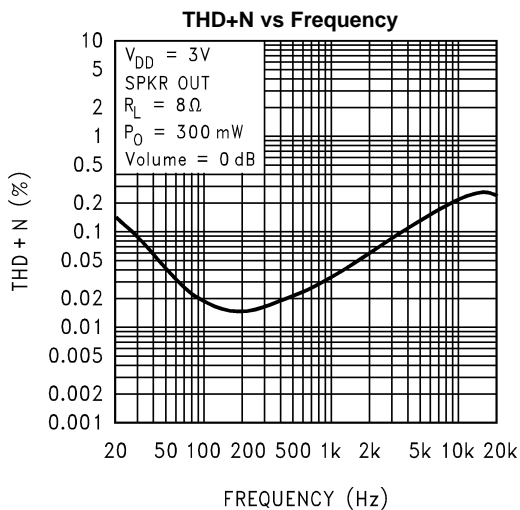

Figure 10.

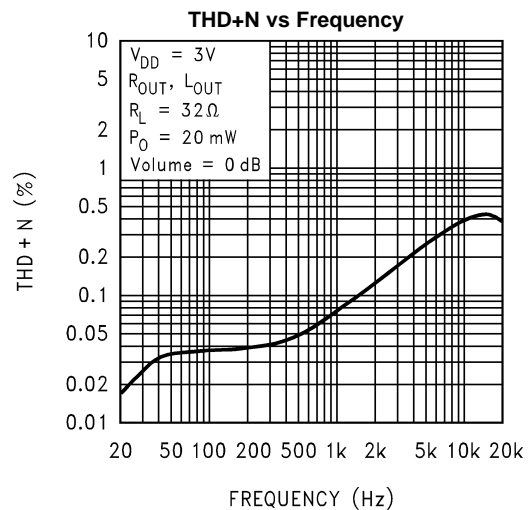

Figure 11.

Typical Performance Characteristics (continued)

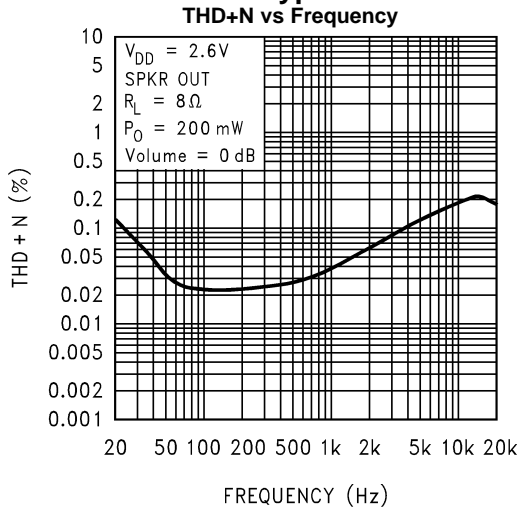

Figure 12.

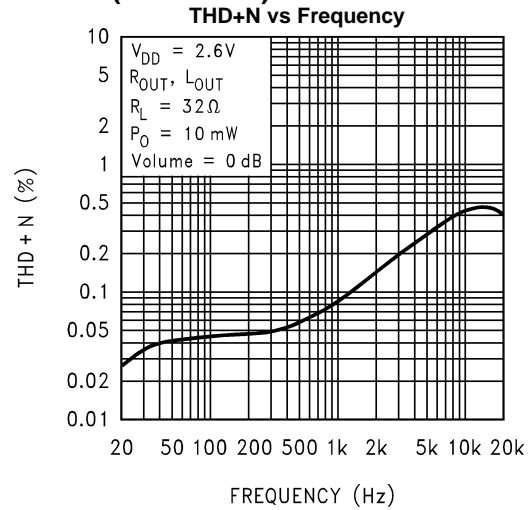

Figure 13.

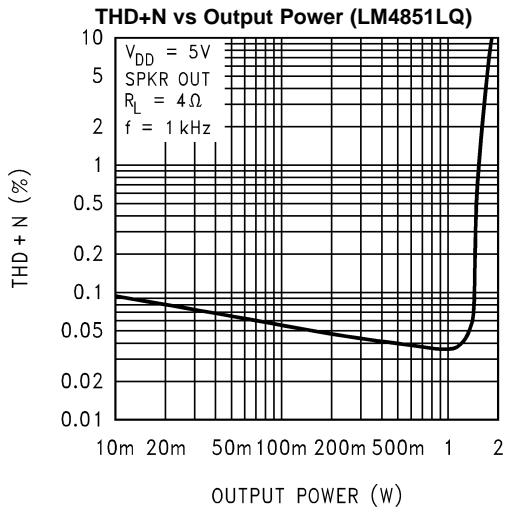

Figure 14.

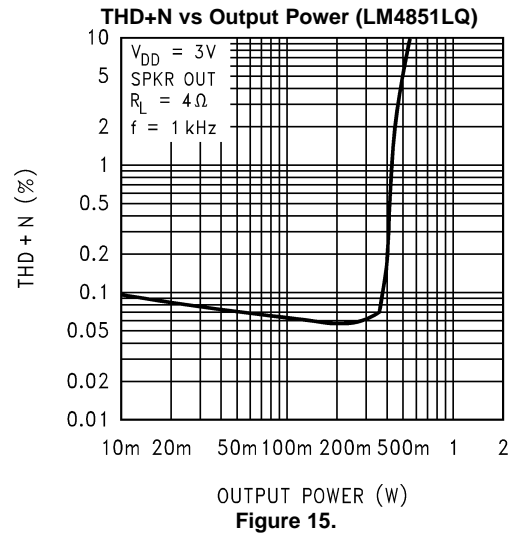

Figure 15.

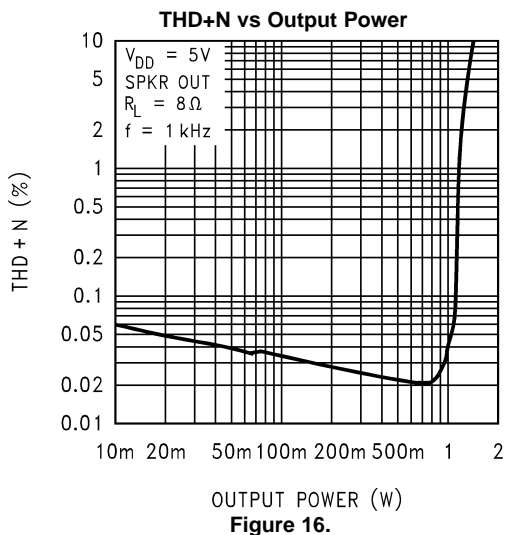

Figure 16.

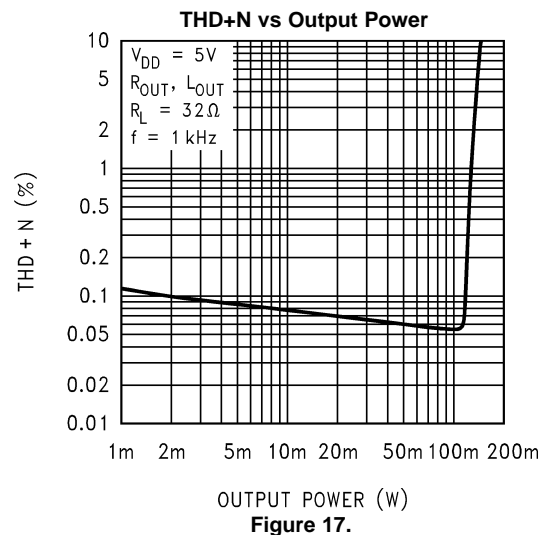

Figure 17.

Typical Performance Characteristics (continued)

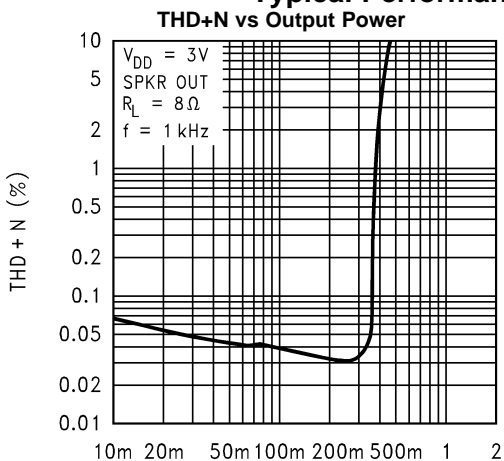

Figure 18.

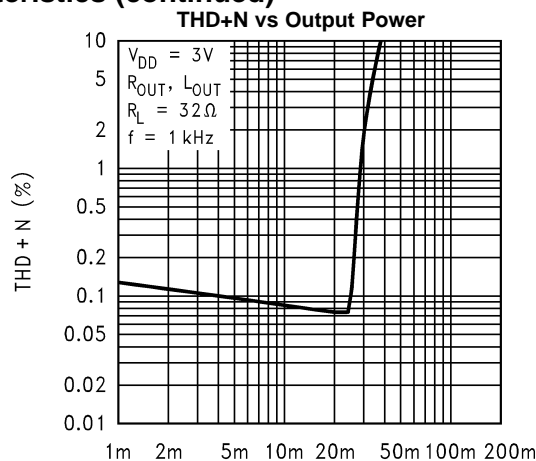

Figure 19.

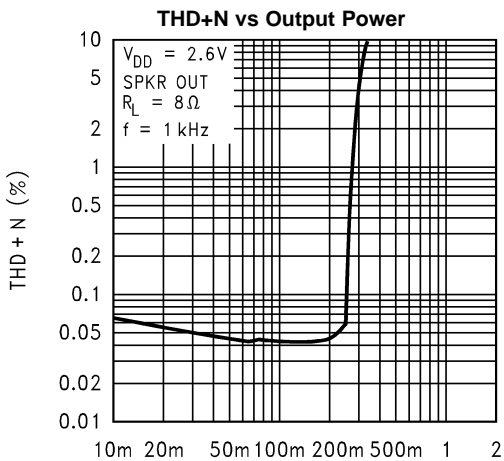

Figure 20.

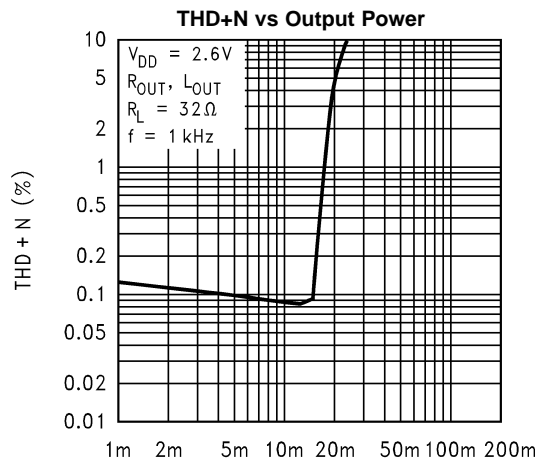

Figure 21.

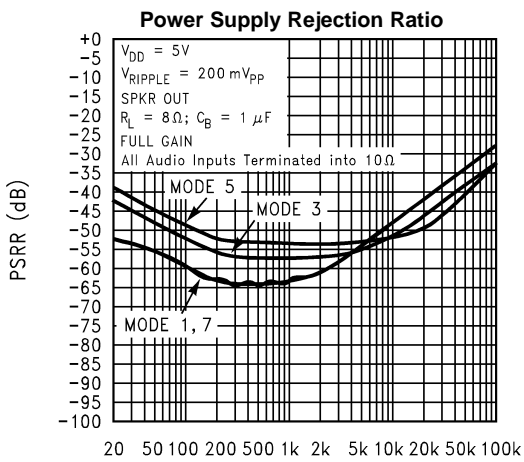

Figure 22.

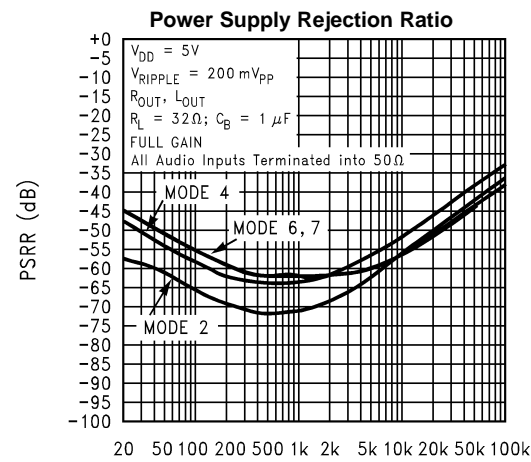

Figure 23.

Typical Performance Characteristics (continued)

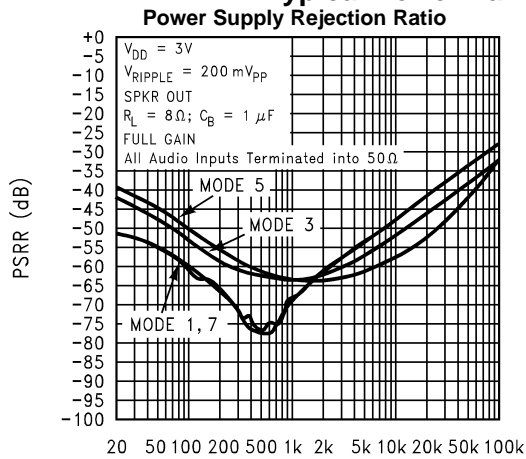

Figure 24.

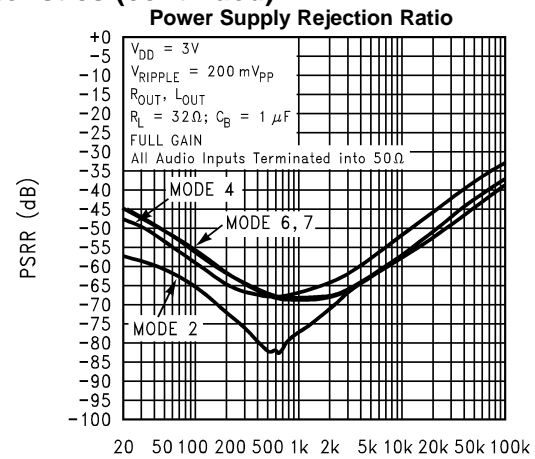

Figure 25.

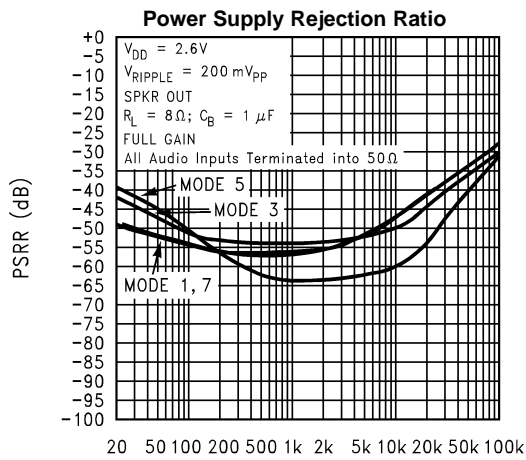

Figure 26.

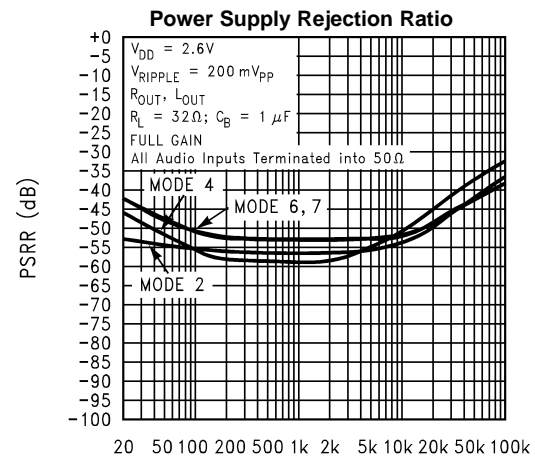

Figure 27.

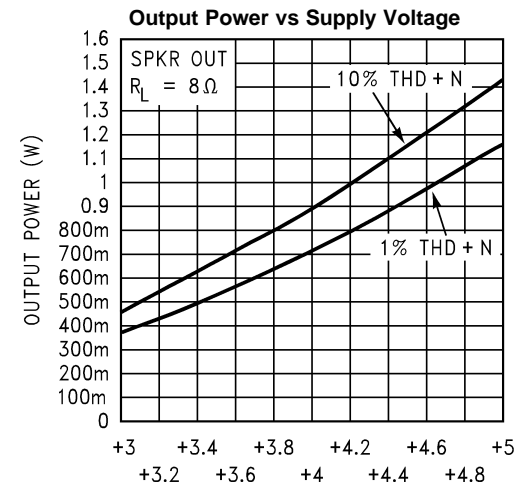

Figure 28.

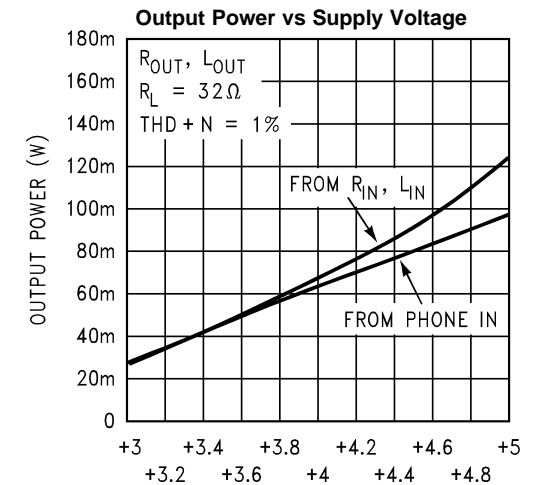

Figure 29.

Typical Performance Characteristics (continued)

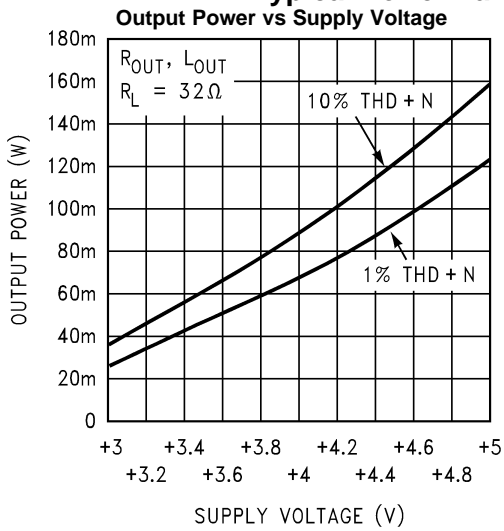

Figure 30.

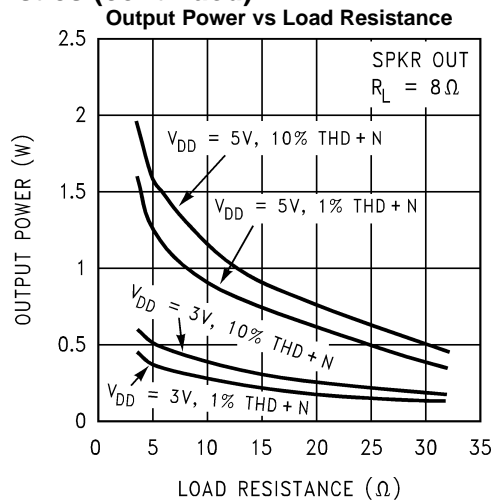

Figure 31.

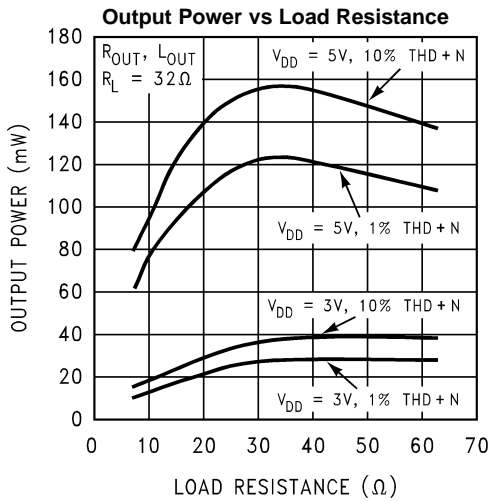

Figure 32.

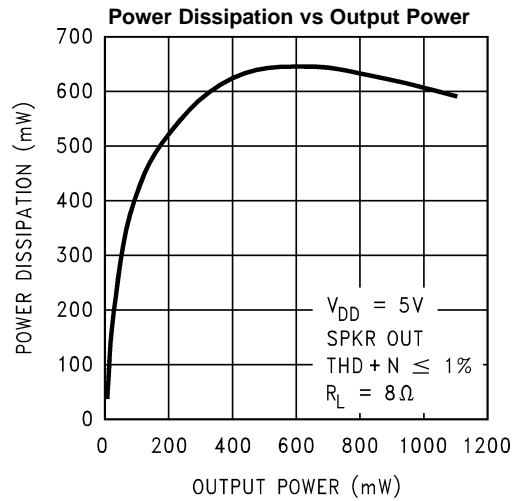

Figure 33.

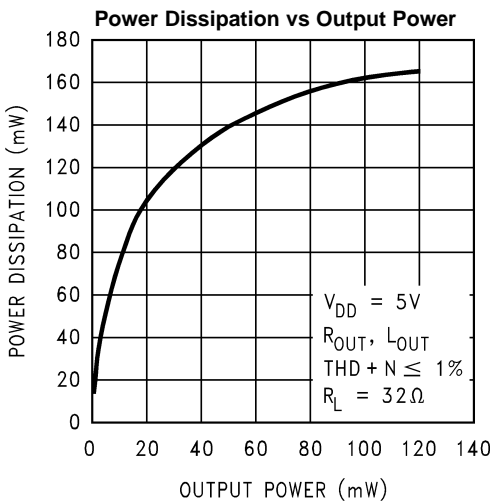

Figure 34.

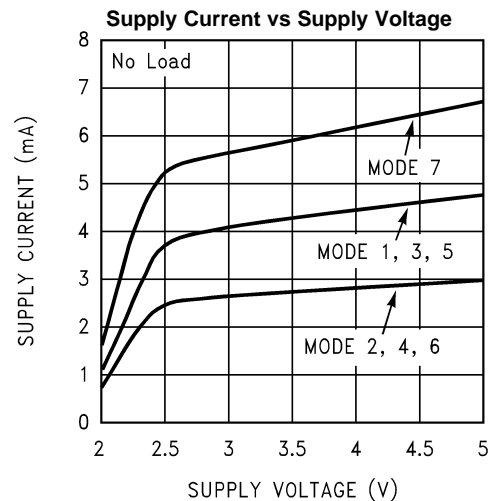

Figure 35.

Typical Performance Characteristics (continued)

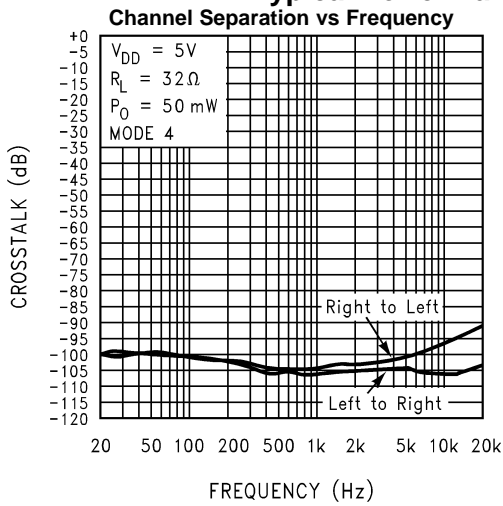

Figure 36.

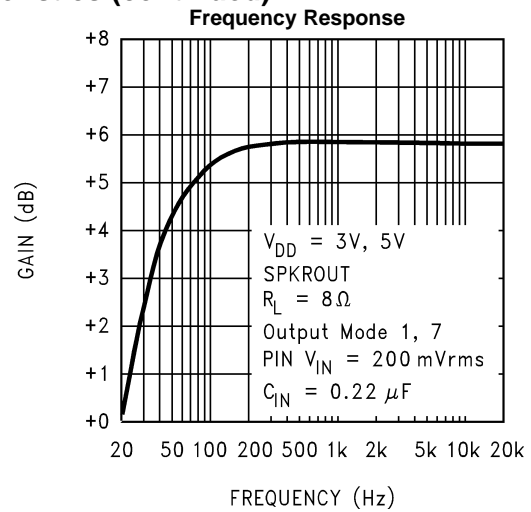

Figure 37.

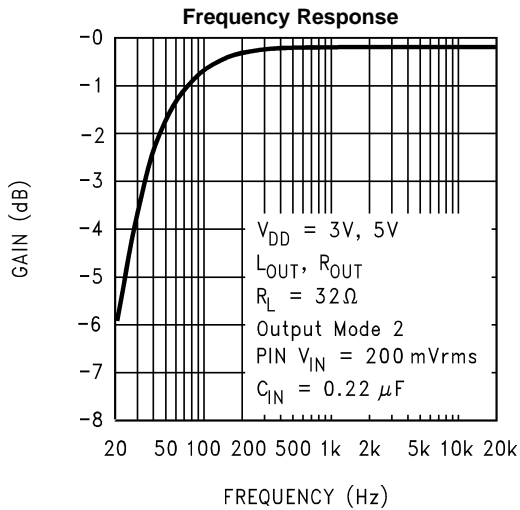

Figure 38.

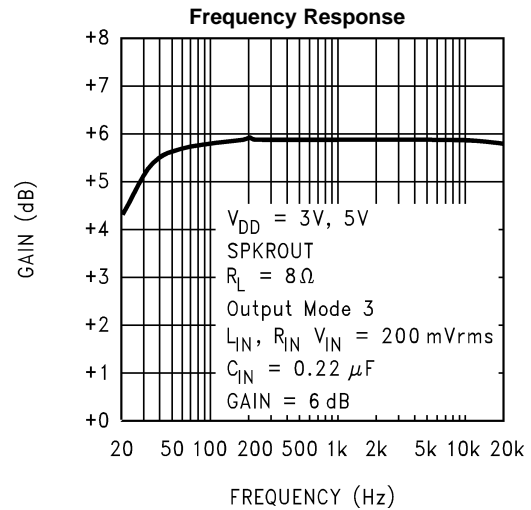

Figure 39.

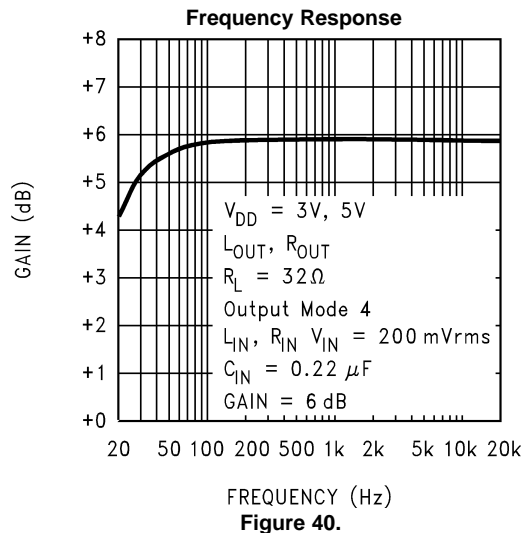

Figure 40.

Typical Performance Characteristics (continued)
Table 2. Output Noise vs Output Mode ($V_{DD} = 3V, 5V$; A-weighted)⁽¹⁾

Output Mode	SPKROUT Output Noise (μV)	LOUT/ROUT Output Noise (μV)
1	29	X
2	X	21
3	37 (G = 0dB) 42 (G = 6dB)	X
4	X	29 (G = 0dB) 32 (G = 6dB)
5	48 (G = 0dB) 53 (G = 6dB)	X
6	X	34 (G = 0dB) 37 (G = 6dB)
7	29	34 (G = 0dB) 37 (G = 6dB)

(1) G = Volume Control Gain
X = Not Applicable

APPLICATION INFORMATION

SPI PIN DESCRIPTION

DATA: This is the serial data input pin.

CLK: This is the clock input pin.

ENB: This is the SPI enable pin and is active-high.

SPI OPERATION DESCRIPTION

The serial data bits are organized into a field which contains 8 bits of data defined by [Table 3](#). The Data 0 to Data 2 bits determine the output mode of the LM4851 as shown in [Table 4](#). The Data 3 to Data 7 bits determine the volume level setting as illustrated by [Table 5](#). For each SPI transfer, the data bits are written to the DATA pin with the least significant bit (LSB) first. All serial data are sampled at the rising edge of the CLK signal. Once all the data bits have been sampled, ENB transitions from logic-high to logic-low to complete the SPI sequence. All 8 bits must be received before any data latch can occur. Any excess CLK and DATA transitions will be ignored after the eighth rising clock edge has occurred. For any data sequence longer than 8 bits, only the first 8 bits will get loaded into the shift register and the rest of the bits will be disregarded.

Table 3. Bit Allocation

Data 0	Mode 1
Data 1	Mode 2
Data 2	Mode 3
Data 3	Volume 1
Data 4	Volume 2
Data 5	Volume 3
Data 6	Volume 4
Data 7	Volume 5

Table 4. Output Mode Selection⁽¹⁾

Output Mode #	Data 2	Data 1	Data 0	SPKR _{OUT}	R _{OUT}	L _{OUT}
0	0	0	0	SD	SD	SD
1	0	0	1	6dB x P	SD	SD
2	0	1	0	SD	P	P
3	0	1	1	G(R+L)	SD	SD
4	1	0	0	SD	G x R	G x L
5	1	0	1	G(R+L) + 6dB x P	SD	SD
6	1	1	0	SD	(G x R) + P	(G x L) + P
7	1	1	1	6dB x P	(G x R) + P	(G x L) + P

- (1) P = Phone In
 R = Rin
 L = Lin
 SD = Shutdown
 G = Gain of volume control
 Default Mode upon device power-up is Output Mode 0

Table 5. Volume Control Settings

Gain (dB)	Data 7	Data 6	Data 5	Data 4	Data 3
-40.5	0	0	0	0	0
-39.0	0	0	0	0	1
-37.5	0	0	0	1	0
-36.0	0	0	0	1	1
-34.5	0	0	1	0	0
-33.0	0	0	1	0	1
-31.5	0	0	1	1	0
-30.0	0	0	1	1	1
-28.5	0	1	0	0	0
-27.0	0	1	0	0	1
-25.5	0	1	0	1	0
-24.0	0	1	0	1	1
-22.5	0	1	1	0	0
-21.0	0	1	1	0	1
-19.5	0	1	1	1	0
-18.0	0	1	1	1	1
-16.5	1	0	0	0	0
-15.0	1	0	0	0	1
-13.5	1	0	0	1	0
-12.0	1	0	0	1	1
-10.5	1	0	1	0	0
-9.0	1	0	1	0	1
-7.5	1	0	1	1	0
-6.0	1	0	1	1	1
-4.5	1	1	0	0	0
-3.0	1	1	0	0	1
-1.5	1	1	0	1	0
0.0	1	1	0	1	1
1.5	1	1	1	0	0
3.0	1	1	1	0	1
4.5	1	1	1	1	0
6.0	1	1	1	1	1

SPI OPERATIONAL REQUIREMENTS

1. The data bits are transmitted with the LSB first.
2. The maximum clock rate is 10MHz for the CLK pin.
3. CLK must remain logic-high for at least 50ns (t_{CH}) after the rising edge of CLK, and CLK must remain logic-low for at least 50ns (t_{CL}) after the falling edge of CLK.
4. The serial data bits are sampled at the rising edge of CLK. Any transition on DATA must occur at least 20ns (t_{DS}) before the rising edge of CLK. Also, any transition on DATA must occur at least 20ns (t_{DH}) after the rising edge of CLK and stabilize before the next rising edge of CLK.
5. ENB should be logic-high only during serial data transmission.
6. ENB must be logic-high at least 20ns (t_{ES}) before the first rising edge of CLK, and ENB has to remain logic-high at least 20ns (t_{EH}) after the eighth rising edge of CLK.
7. If ENB remains logic-low for more than 10ns before all 8 bits are transmitted then the data latch will be aborted.
8. If ENB is logic-high for more than 8 CLK pulses then only the first 8 data bits will be latched and activated when ENB transitions to logic-low.
9. ENB must remain logic-low for at least 30ns (t_{EL}) after all 8 bits are transmitted to latch in the data.
10. Coincidental rising or falling edges of CLK and ENB are not allowed. If CLK is to be held logic-high after the data transmission, the falling edge of CLK must occur at least 20ns (t_{CS}) before ENB transitions to logic-high for the next set of data.

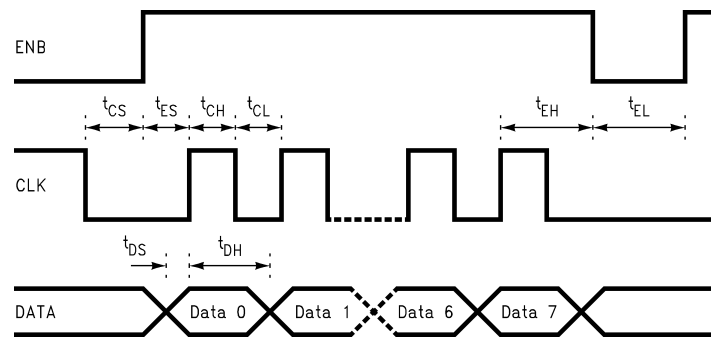

Figure 41. SPI Timing Diagram

EXPOSED-DAP MOUNTING CONSIDERATIONS

The LM4851's exposed-DAP (die attach paddle) package (LQ) provides a low thermal resistance between the die and the PCB to which the part is mounted and soldered. This allows rapid heat transfer from the die to the surrounding PCB copper area heatsink, copper traces, ground plane, and finally, surrounding air. The result is a low voltage audio power amplifier that produces 1.1W dissipation in an 8Ω load at ≤ 1% THD+N. This high power is achieved through careful consideration of necessary thermal design. Failing to optimize thermal design may compromise the LM4851's high power performance and activate unwanted, though necessary, thermal shutdown protection.

The LQ package must have its DAP soldered to a copper pad on the PCB. The DAP's PCB copper pad is then, ideally, connected to a large plane of continuous unbroken copper. This plane forms a thermal mass, heat sink, and radiation area. Place the heat sink area on either outside plane in the case of a two-sided or multi-layer PCB. (The heat sink area can also be placed on an inner layer of a multi-layer board. The thermal resistance, however, will be higher.) Connect the DAP copper pad to the inner layer or backside copper heat sink area with 6 (3 X 2) (LQ) vias. The via diameter should be 0.012in - 0.013in with a 1.27mm pitch. Ensure efficient thermal conductivity by plugging and tenting the vias with plating and solder mask, respectively.

Best thermal performance is achieved with the largest practical copper heat sink area. If the heatsink and amplifier share the same PCB layer, a nominal 2.5in^2 (min) area is necessary for 5V operation with a 4Ω load. Heatsink areas not placed on the same PCB layer as the LM4851 should be 5in^2 (min) for the same supply voltage and load resistance. The last two area recommendations apply for 25°C ambient temperature. Increase the area to compensate for ambient temperatures above 25°C . In all circumstances and under all conditions, the junction temperature must be held below 150°C to prevent activating the LM4851's thermal shutdown protection. Further detailed and specific information concerning PCB layout and fabrication and mounting an LQ (LLP) is found in TI's AN-1187 (literature number [SNOA401](#)).

PCB LAYOUT AND SUPPLY REGULATION CONSIDERATIONS FOR DRIVING 3Ω AND 4Ω LOADS

Power dissipated by a load is a function of the voltage swing across the load and the load's impedance. As load impedance decreases, load dissipation becomes increasingly dependent on the interconnect (PCB trace and wire) resistance between the amplifier output pins and the load's connections. Residual trace resistance causes a voltage drop, which results in power dissipated in the trace and not in the load as desired. For example, 0.1Ω trace resistance reduces the output power dissipated by a 4Ω load from 1.7W to 1.6W . The problem of decreased load dissipation is exacerbated as load impedance decreases. Therefore, to maintain the highest load dissipation and widest output voltage swing, PCB traces that connect the output pins to a load must be as wide as possible.

Poor power supply regulation adversely affects maximum output power. A poorly regulated supply's output voltage decreases with increasing load current. Reduced supply voltage causes decreased headroom, output signal clipping, and reduced output power. Even with tightly regulated supplies, trace resistance creates the same effects as poor supply regulation. Therefore, making the power supply traces as wide as possible helps maintain full output voltage swing.

BRIDGE CONFIGURATION EXPLANATION

As shown in [Figure 1](#), the LM4851 consists of three pairs of output amplifier blocks (A4-A6). A4, A5, and A6 consist of bridged-tied amplifier pairs that drive LOUT, ROUT, and SPKROUT respectively. The LM4851 drives a load, such as a speaker, connected between outputs, SPKROUT+ and SPKROUT-. In the amplifier block A6, the output of the amplifier that drives SPKROUT- serves as the input to the unity gain inverting amplifier that drives SPKROUT+.

This results in both amplifiers producing signals identical in magnitude, but 180° out of phase. Taking advantage of this phase difference, a load is placed between SPKROUT- and SPKROUT+ and driven differentially (commonly referred to as 'bridge mode'). Assuming $R_F = R_i$, this results in a differential or BTL gain of:

$$A_{VD} = 2(R_F/R_i) = 2 \quad (1)$$

Bridge mode amplifiers are different from single-ended amplifiers that drive loads connected between a single amplifier's output and ground. For a given supply voltage, bridge mode has a distinct advantage over the single-ended configuration: its differential output doubles the voltage swing across the load. Theoretically, this produces four times the output power when compared to a single-ended amplifier under the same conditions. This increase in attainable output power assumes that the amplifier is not current limited and that the output signal is not clipped.

Another advantage of the differential bridge output is no net DC voltage across the load. This is accomplished by biasing SPKROUT- and SPKROUT+ outputs at half-supply. This eliminates the coupling capacitor that single supply, single-ended amplifiers require. Eliminating an output coupling capacitor in a typical single-ended configuration forces a single-supply amplifier's half-supply bias voltage across the load. This increases internal IC power dissipation and may permanently damage loads such as speakers.

POWER DISSIPATION

Power dissipation is a major concern when designing a successful single-ended or bridged amplifier.

A direct consequence of the increased power delivered to the load by a bridge amplifier is higher internal power dissipation. The LM4851 has a pair of bridged-tied amplifiers driving a handsfree speaker, SPKROUT. The maximum internal power dissipation operating in the bridge mode is twice that of a single-ended amplifier. From [Equation \(2\)](#), assuming a 5V power supply and an 8Ω load, the maximum SPKROUT power dissipation is 634mW.

$$P_{\text{DMAX-SPKROUT}} = 4(V_{\text{DD}})^2 / (2\pi^2 R_L): \text{ Bridge Mode} \quad (2)$$

The LM4851 also has 2 pairs of bridged-tied amplifiers driving stereo headphones, ROUT and LOUT. The maximum internal power dissipation for ROUT and LOUT is given by [Equation \(3\)](#) and [Equation \(4\)](#). From [Equation \(3\)](#) and [Equation \(4\)](#), assuming a 5V power supply and a 32Ω load, the maximum power dissipation for LOUT and ROUT is 158mW, or 316mW total.

$$P_{\text{DMAX-LOUT}} = 4(V_{\text{DD}})^2 / (2\pi^2 R_L): \text{ Bridge Mode} \quad (3)$$

$$P_{\text{DMAX-ROUT}} = 4(V_{\text{DD}})^2 / (2\pi^2 R_L): \text{ Bridge Mode} \quad (4)$$

The maximum internal power dissipation of the LM4851 occurs when all 3 amplifiers pairs are simultaneously on; and is given by [Equation \(5\)](#).

$$P_{\text{DMAX-TOTAL}} = P_{\text{DMAX-SPKROUT}} + P_{\text{DMAX-LOUT}} + P_{\text{DMAX-ROUT}} \quad (5)$$

The maximum power dissipation point given by [Equation \(5\)](#) must not exceed the power dissipation given by [Equation \(6\)](#):

$$P_{\text{DMAX}'} = (T_{\text{JMAX}} - T_A) / \theta_{\text{JA}} \quad (6)$$

The LM4851's $T_{\text{JMAX}} = 150^\circ\text{C}$. In the IBL and ITL packages, the LM4851's θ_{JA} is 48°C/W. In the LQ package soldered to a DAP pad that expands to a copper area of 2.5in² on a PCB, the LM4851's θ_{JA} is 42°C/W. At any given ambient temperature T_A , use [Equation \(6\)](#) to find the maximum internal power dissipation supported by the IC packaging. Rearranging [Equation \(6\)](#) and substituting $P_{\text{DMAX-TOTAL}}$ for $P_{\text{DMAX}'}$ results in [Equation \(7\)](#). This equation gives the maximum ambient temperature that still allows maximum stereo power dissipation without violating the LM4851's maximum junction temperature.

$$T_A = T_{\text{JMAX}} - P_{\text{DMAX-TOTAL}} \theta_{\text{JA}} \quad (7)$$

For a typical application with a 5V power supply and an 8Ω load, the maximum ambient temperature that allows maximum stereo power dissipation without exceeding the maximum junction temperature is approximately 104°C for the IBL package.

$$T_{\text{JMAX}} = P_{\text{DMAX-TOTAL}} \theta_{\text{JA}} + T_A \quad (8)$$

[Equation \(8\)](#) gives the maximum junction temperature T_{JMAX} . If the result violates the LM4851's 150°C, reduce the maximum junction temperature by reducing the power supply voltage or increasing the load resistance. Further allowance should be made for increased ambient temperatures.

The above examples assume that a device is a surface mount part operating around the maximum power dissipation point. Since internal power dissipation is a function of output power, higher ambient temperatures are allowed as output power or duty cycle decreases. If the result of [Equation \(5\)](#) is greater than that of [Equation \(6\)](#), then decrease the supply voltage, increase the load impedance, or reduce the ambient temperature. If these measures are insufficient, a heat sink can be added to reduce θ_{JA} . The heat sink can be created using additional copper area around the package, with connections to the ground pin(s), supply pin and amplifier output pins. External, solder attached SMT heatsinks such as the Thermalloy 7106D can also improve power dissipation. When adding a heat sink, the θ_{JA} is the sum of θ_{JC} , θ_{CS} , and θ_{SA} . (θ_{JC} is the junction-to-case thermal impedance, θ_{CS} is the case-to-sink thermal impedance, and θ_{SA} is the sink-to-ambient thermal impedance.) Refer to the [Typical Performance Characteristics](#) curves for power dissipation information at lower output power levels.

POWER SUPPLY BYPASSING

As with any power amplifier, proper supply bypassing is critical for low noise performance and high power supply rejection. Applications that employ a 5V regulator typically use a 10 μ F in parallel with a 0.1 μ F filter capacitors to stabilize the regulator's output, reduce noise on the supply line, and improve the supply's transient response. However, their presence does not eliminate the need for a local 1.0 μ F tantalum bypass capacitance connected between the LM4851's supply pins and ground. Keep the length of leads and traces that connect capacitors between the LM4851's power supply pin and ground as short as possible. Connecting a 1 μ F capacitor, C_B , between the BYPASS pin and ground improves the internal bias voltage's stability and improves the amplifier's PSRR. The PSRR improvements increase as the bypass pin capacitor value increases. Too large, however, increases turn-on time and can compromise the amplifier's click and pop performance. The selection of bypass capacitor values, especially C_B , depends on desired PSRR requirements, click and pop performance (as explained in the section [Proper Selection of External Components](#)), system cost, and size constraints.

SELECTING EXTERNAL COMPONENTS

Input Capacitor Value Selection

Amplifying the lowest audio frequencies requires high value input coupling capacitor (C_i in [Figure 1](#)). A high value capacitor can be expensive and may compromise space efficiency in portable designs. In many cases, however, the speakers used in portable systems, whether internal or external, have little ability to reproduce signals below 150Hz. Applications using speakers with this limited frequency response reap little improvement by using large input capacitor.

The internal input resistor (R_i) and the input capacitor (C_i) produce a high pass filter cutoff frequency that is found using [Equation \(9\)](#).

$$f_c = 1 / (2\pi R_i C_i) \quad (9)$$

As an example when using a speaker with a low frequency limit of 150Hz, C_i , using [Equation \(9\)](#) is 0.063 μ F. The 0.22 μ F C_i shown in [Figure 1](#) allows the LM4851 to drive high efficiency, full range speaker whose response extends below 40Hz.

Bypass Capacitor Value Selection

Besides minimizing the input capacitor size, careful consideration should be paid to value of C_B , the capacitor connected to the BYPASS pin. Since C_B determines how fast the LM4851 settles to quiescent operation, its value is critical when minimizing turn-on pops. The slower the LM4851's outputs ramp to their quiescent DC voltage (nominally $V_{DD}/2$), the smaller the turn-on pop. Choosing C_B equal to 1.0 μ F along with a small value of C_i (in the range of 0.1 μ F to 0.39 μ F), produces a click-less and pop-less shutdown function. As discussed above, choosing C_i no larger than necessary for the desired bandwidth helps minimize clicks and pops. C_B 's value should be in the range of 5 times to 7 times the value of C_i . This ensures that output transients are eliminated when power is first applied or the LM4851 resumes operation after shutdown.

Demonstration Board Layout

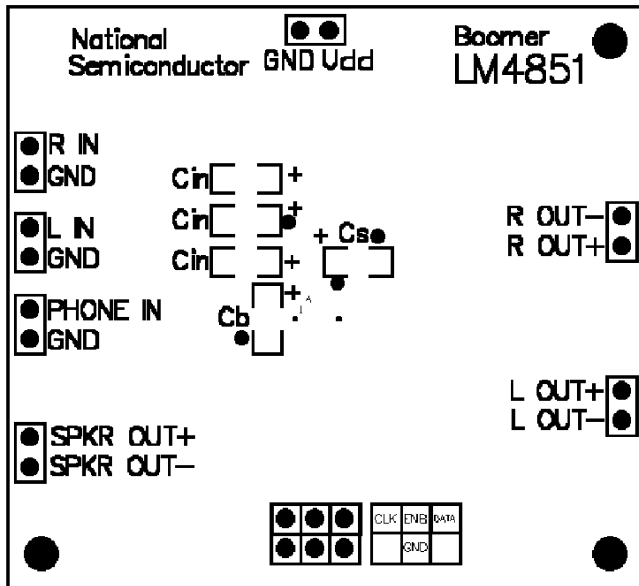

Figure 42. Recommended IBL, ITL PC Board Layout: Top Silkscreen

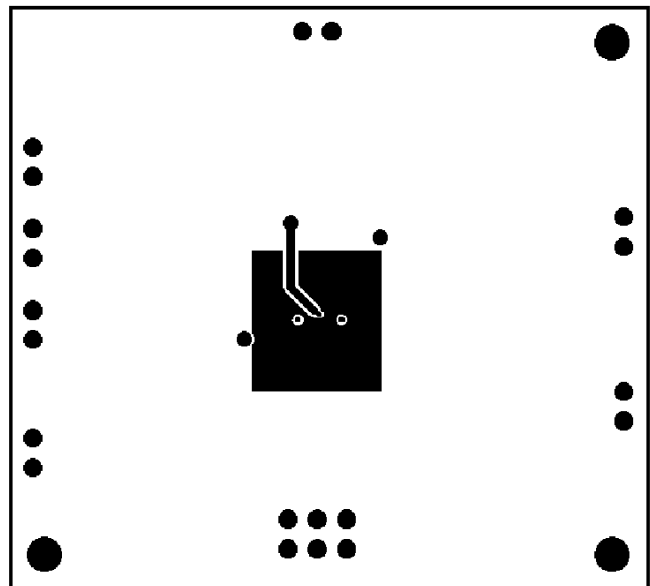

Figure 43. Recommended IBL, ITL PC Board Layout: Inner Layer

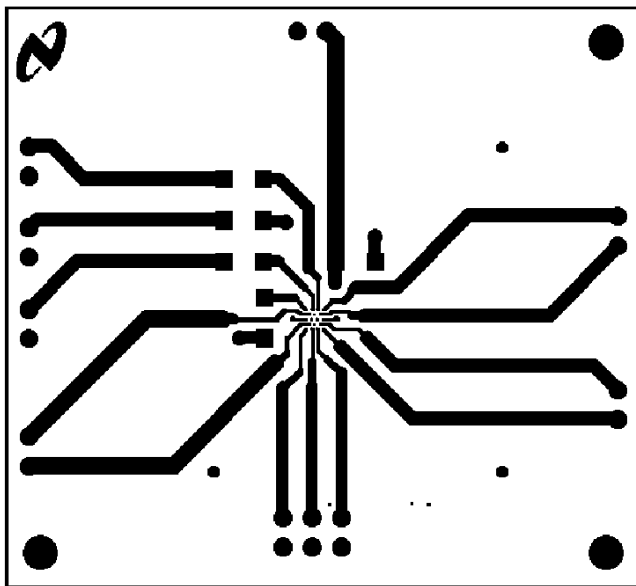

Figure 44. Recommended IBL, ITL PC Board Layout: Top Layer

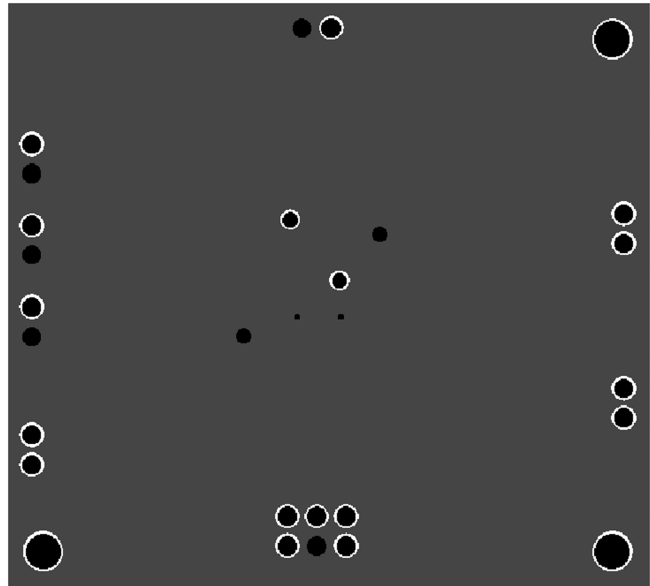

Figure 45. Recommended IBL, ITL PC Board Layout: Bottom Layer

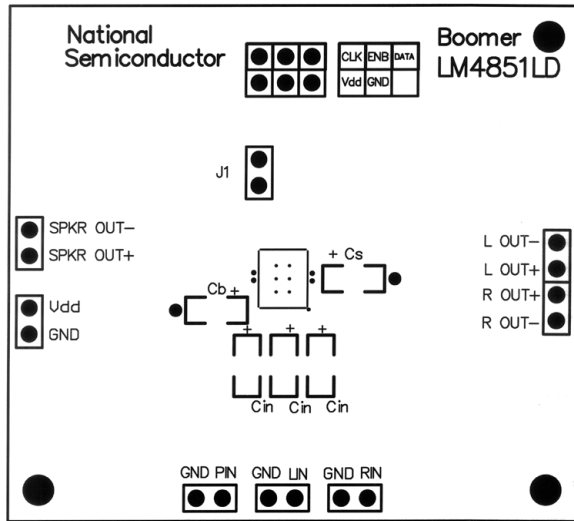

Figure 46. Recommended LQ PC Board Layout: Top Silkscreen Layer

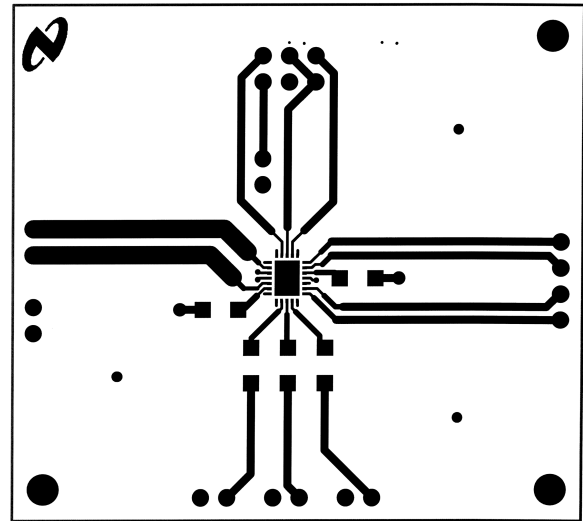

Figure 47. Recommended LQ PC Board Layout: Top Layer

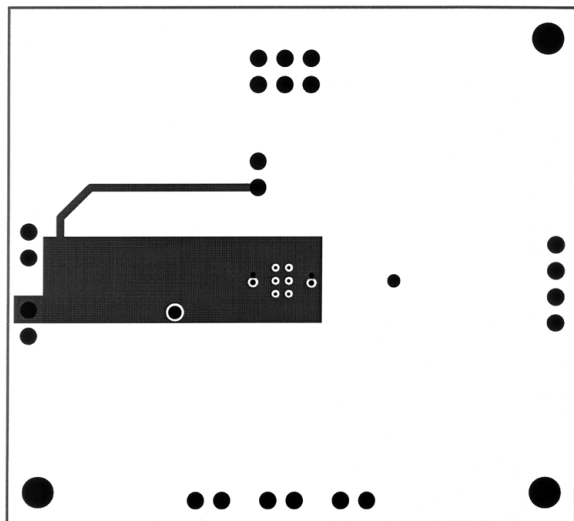

Figure 48. Recommended LQ PC Board Layout: Inner Layer 1

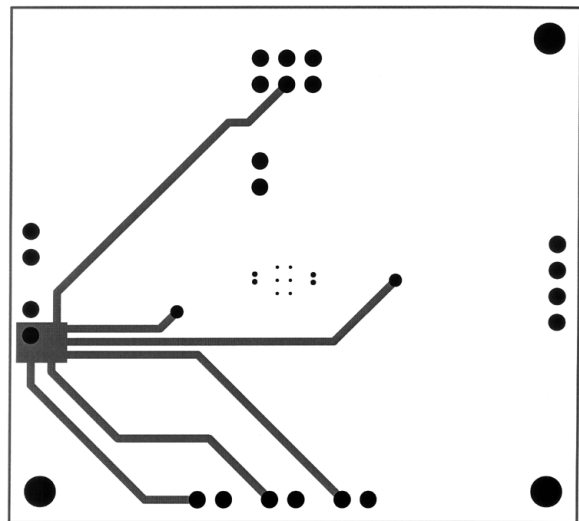

Figure 49. Recommended LQ PC Board Layout: Inner Layer 2

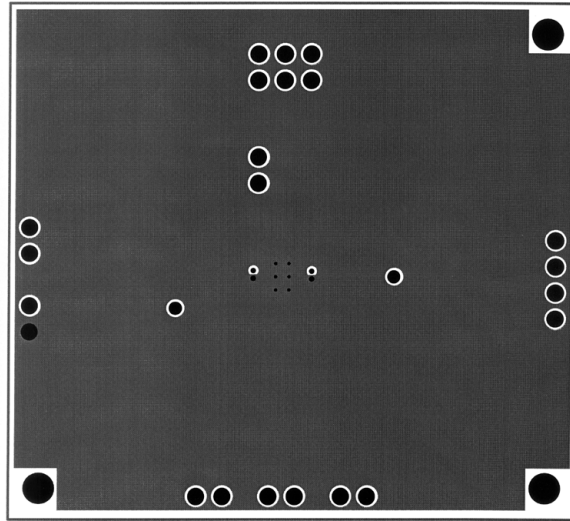

Figure 50. Recommended LQ PC Board Layout:
Bottom Layer

IMPORTANT NOTICE

Texas Instruments Incorporated and its subsidiaries (TI) reserve the right to make corrections, enhancements, improvements and other changes to its semiconductor products and services per JESD46, latest issue, and to discontinue any product or service per JESD48, latest issue. Buyers should obtain the latest relevant information before placing orders and should verify that such information is current and complete. All semiconductor products (also referred to herein as "components") are sold subject to TI's terms and conditions of sale supplied at the time of order acknowledgment.

TI warrants performance of its components to the specifications applicable at the time of sale, in accordance with the warranty in TI's terms and conditions of sale of semiconductor products. Testing and other quality control techniques are used to the extent TI deems necessary to support this warranty. Except where mandated by applicable law, testing of all parameters of each component is not necessarily performed.

TI assumes no liability for applications assistance or the design of Buyers' products. Buyers are responsible for their products and applications using TI components. To minimize the risks associated with Buyers' products and applications, Buyers should provide adequate design and operating safeguards.

TI does not warrant or represent that any license, either express or implied, is granted under any patent right, copyright, mask work right, or other intellectual property right relating to any combination, machine, or process in which TI components or services are used. Information published by TI regarding third-party products or services does not constitute a license to use such products or services or a warranty or endorsement thereof. Use of such information may require a license from a third party under the patents or other intellectual property of the third party, or a license from TI under the patents or other intellectual property of TI.

Reproduction of significant portions of TI information in TI data books or data sheets is permissible only if reproduction is without alteration and is accompanied by all associated warranties, conditions, limitations, and notices. TI is not responsible or liable for such altered documentation. Information of third parties may be subject to additional restrictions.

Resale of TI components or services with statements different from or beyond the parameters stated by TI for that component or service voids all express and any implied warranties for the associated TI component or service and is an unfair and deceptive business practice. TI is not responsible or liable for any such statements.

Buyer acknowledges and agrees that it is solely responsible for compliance with all legal, regulatory and safety-related requirements concerning its products, and any use of TI components in its applications, notwithstanding any applications-related information or support that may be provided by TI. Buyer represents and agrees that it has all the necessary expertise to create and implement safeguards which anticipate dangerous consequences of failures, monitor failures and their consequences, lessen the likelihood of failures that might cause harm and take appropriate remedial actions. Buyer will fully indemnify TI and its representatives against any damages arising out of the use of any TI components in safety-critical applications.

In some cases, TI components may be promoted specifically to facilitate safety-related applications. With such components, TI's goal is to help enable customers to design and create their own end-product solutions that meet applicable functional safety standards and requirements. Nonetheless, such components are subject to these terms.

No TI components are authorized for use in FDA Class III (or similar life-critical medical equipment) unless authorized officers of the parties have executed a special agreement specifically governing such use.

Only those TI components which TI has specifically designated as military grade or "enhanced plastic" are designed and intended for use in military/aerospace applications or environments. Buyer acknowledges and agrees that any military or aerospace use of TI components which have **not** been so designated is solely at the Buyer's risk, and that Buyer is solely responsible for compliance with all legal and regulatory requirements in connection with such use.

TI has specifically designated certain components as meeting ISO/TS16949 requirements, mainly for automotive use. In any case of use of non-designated products, TI will not be responsible for any failure to meet ISO/TS16949.

Products

Audio	www.ti.com/audio
Amplifiers	amplifier.ti.com
Data Converters	dataconverter.ti.com
DLP® Products	www.dlp.com
DSP	dsp.ti.com
Clocks and Timers	www.ti.com/clocks
Interface	interface.ti.com
Logic	logic.ti.com
Power Mgmt	power.ti.com
Microcontrollers	microcontroller.ti.com
RFID	www.ti-rfid.com
OMAP Applications Processors	www.ti.com/omap
Wireless Connectivity	www.ti.com/wirelessconnectivity

Applications

Automotive and Transportation	www.ti.com/automotive
Communications and Telecom	www.ti.com/communications
Computers and Peripherals	www.ti.com/computers
Consumer Electronics	www.ti.com/consumer-apps
Energy and Lighting	www.ti.com/energy
Industrial	www.ti.com/industrial
Medical	www.ti.com/medical
Security	www.ti.com/security
Space, Avionics and Defense	www.ti.com/space-avionics-defense
Video and Imaging	www.ti.com/video

TI E2E Community

e2e.ti.com

Looking for pricing, stock, or lifecycle information?

Click below to explore more details on WIN SOURCE:

 [View LM4851ITLX](#) on WIN SOURCE

 [Texas Instruments](#) Information

Optimize Your Supply Chain with WIN SOURCE Solutions

-  Global Sourcing Solution
-  Obsolete Management
-  Cost Control Management
-  Shortage Management
-  Alternative Solution
-  Excess Inventory Management