



# THE DATASHEET OF LM4809LDX



# LM4809 Boomer<sup>®</sup> Audio Power Amplifier Series **Dual 105mW Headphone Amplifier with Active-Low Shutdown Mode**

Check for Samples: [LM4809](#), [LM4809LQBD](#)

## FEATURES

- **Active-Low Shutdown Mode**
- **"Click and Pop" Reduction Circuitry**
- **Low Shutdown Current**
- **WSON, MSOP, and SOIC Surface Mount Packaging**
- **No Bootstrap Capacitors Required**
- **Unity-Gain Stable**

## APPLICATIONS

- **Headphone Amplifier**
- **Personal Computers**
- **Microphone Preamplifier**
- **PDA's**

## KEY SPECIFICATIONS

- **THD+N at 1kHz at 105mW Continuous Average Power into 16Ω 0.1% (typ)**
- **THD+N at 1kHz at 70mW Continuous Average Power into 32Ω 0.1% (typ)**
- **Shutdown Current 0.4μA (typ)**

## DESCRIPTION

The LM4809 is a dual audio power amplifier capable of delivering 105mW per channel of continuous average power into a 16Ω load with 0.1% (THD+N) from a 5V power supply.

Boomer audio power amplifiers were designed specifically to provide high quality output power with a minimal amount of external components. Since the LM4809 does not require bootstrap capacitors or snubber networks, it is optimally suited for low-power portable systems.

The unity-gain stable LM4809 can be configured by external gain-setting resistors.

The LM4809 features an externally controlled, active-low, micropower consumption shutdown mode, as well as an internal thermal shutdown protection mechanism.



Please be aware that an important notice concerning availability, standard warranty, and use in critical applications of Texas Instruments semiconductor products and disclaimers thereto appears at the end of this data sheet.

All trademarks are the property of their respective owners.

Typical Application

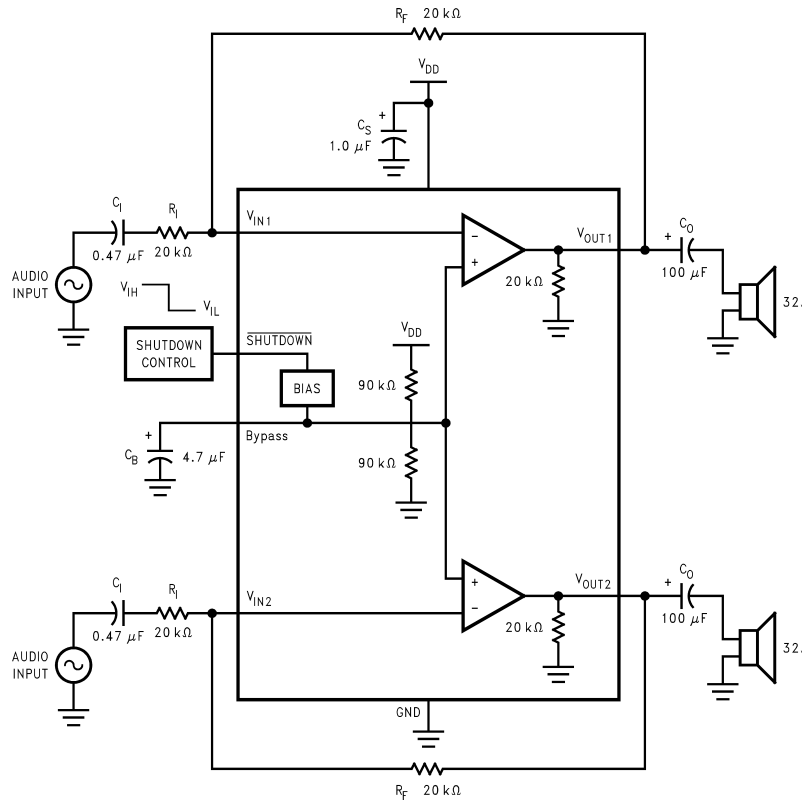

\*Refer to [Application Information](#) for information concerning proper selection of the input and output coupling capacitors.

Figure 1. Typical Audio Amplifier Application Circuit

Connection Diagrams

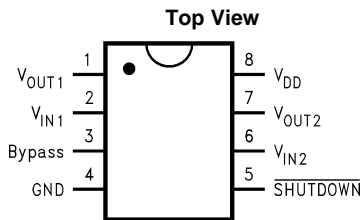

Figure 2. VSSOP Package  
See Package Number DGK0008A

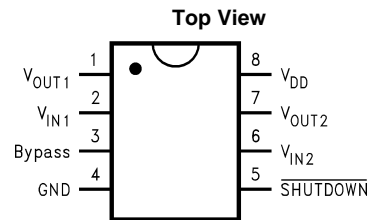
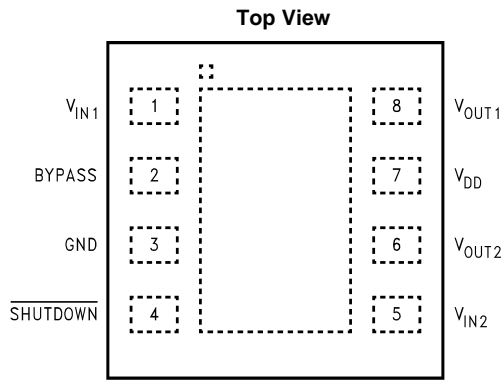
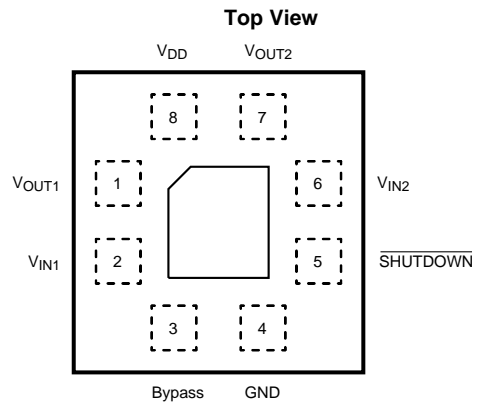

Figure 3. SOIC Package  
See Package Number D0008A



**Figure 4. WSON Package**  
See Package Number NGL0008B



**Figure 5. WSON Package**  
See Package Number NGP0008A



These devices have limited built-in ESD protection. The leads should be shorted together or the device placed in conductive foam during storage or handling to prevent electrostatic damage to the MOS gates.

### Absolute Maximum Ratings <sup>(1)(2)</sup>

Supply Voltage		6.0V	
Storage Temperature		-65°C to +150°C	
ESD Susceptibility <sup>(3)</sup>		3.5kV	
ESD Machine model <sup>(4)</sup>		250V	
Junction Temperature (T <sub>J</sub> )		150°C	
Soldering Information	SOIC Package	Vapor Phase (60 sec.)	215°C
		Infrared (15 sec.)	220°C
Thermal Resistance		θ <sub>JA</sub> (SOIC)	170°C/W
		θ <sub>JC</sub> (SOIC)	35°C/W
		θ <sub>JA</sub> (MSOP)	210°C/W
		θ <sub>JC</sub> (MSOP)	56°C/W
		θ <sub>JA</sub> (WSON)	117°C/W <sup>(5)</sup>
		θ <sub>JA</sub> (WSON)	150°C/W <sup>(6)</sup>
		θ <sub>JC</sub> (WSON)	15°C/W

- (1) *Absolute Maximum Ratings* indicate limits beyond which damage to the device may occur.
- (2) If Military/Aerospace specified devices are required, please contact the Texas Instruments Sales Office/ Distributors for availability and specifications.
- (3) Human body model, 100pF discharged through a 1.5kΩ resistor.
- (4) Machine Model ESD test is covered by specification EIAJ IC-121-1981. A 200pF cap is charged to the specified voltage, then discharged directly into the IC with no external series resistor (resistance of discharge path must be under 50Ω).
- (5) The given θ<sub>JA</sub> is for an LM4809 packaged in an NGL0008B with the Exposed-Dap soldered to a printed circuit board copper pad with an area equivalent to that of the Exposed-Dap itself.
- (6) The given θ<sub>JA</sub> is for an LM4809 packaged in an NGL0008B with the Exposed-Dap not soldered to any printed circuit board copper.

### Operating Ratings

Temperature Range	T <sub>MIN</sub> ≤ T <sub>A</sub> ≤ T <sub>MAX</sub>	-40°C ≤ T <sub>A</sub> ≤ 85°C
Supply Voltage (V <sub>CC</sub> )		2.0V ≤ V <sub>CC</sub> ≤ 5.5V

### Electrical Characteristics V<sub>DD</sub> = 5V <sup>(1)(2)</sup>

The following specifications apply for V<sub>DD</sub> = 5V unless otherwise specified, limits apply to T<sub>A</sub> = 25°C.

Parameter	Test Conditions	LM4809		Units (Limits)	
		Typ <sup>(3)</sup>	Limit <sup>(4)</sup>		
V <sub>DD</sub>	Supply Voltage		2.0	V (min)	
			5.5	V (max)	
I <sub>DD</sub>	Supply Current	V <sub>IN</sub> = 0V, I <sub>O</sub> = 0A	1.4	3	mA (max)
I <sub>SD</sub>	Shutdown Current	V <sub>IN</sub> = 0V, V <sub>SHUTDOWN</sub> = GND	0.4	2	μA(max)
V <sub>OS</sub>	Output Offset Voltage	V <sub>IN</sub> = 0V	4.0	50	mV(max)
P <sub>O</sub>	Output Power	THD+N = 0.1%, f = 1kHz			
		R <sub>L</sub> = 16Ω	105		mW
		R <sub>L</sub> = 32Ω	70	65	mW (min)
THD+N	Total Harmonic Distortion	P <sub>O</sub> = 50mW, R <sub>L</sub> = 32Ω f = 20Hz to 20kHz	0.3		%
Crosstalk	Channel Separation	R <sub>L</sub> = 32Ω; P <sub>O</sub> = 70mW	70		dB
PSRR	Power Supply Rejection Ratio	C <sub>B</sub> = 1.0μF; V <sub>RIPPLE</sub> = 200mV <sub>PP</sub> , f = 1kHz; Input terminated into 50Ω	70		dB

- (1) *Absolute Maximum Ratings* indicate limits beyond which damage to the device may occur.
- (2) All voltages are measured with respect to the ground pin, unless otherwise specified.
- (3) Typical specifications are specified at +25°C and represent the most likely parametric norm.
- (4) Datasheet min/max specification limits are ensured by design, test, or statistical analysis.

### Electrical Characteristics $V_{DD} = 5V$ <sup>(1)(2)</sup> (continued)

The following specifications apply for  $V_{DD} = 5V$  unless otherwise specified, limits apply to  $T_A = 25^\circ C$ .

Parameter		Test Conditions	LM4809		Units (Limits)
			Typ <sup>(3)</sup>	Limit <sup>(4)</sup>	
$V_{SDIH}$	Shutdown Voltage Input High			$0.8 \times V_{DD}$	V (min)
$V_{SDIL}$	Shutdown Voltage Input Low			$0.2 \times V_{DD}$	V (max)

### Electrical Characteristics $V_{DD} = 3.3V$ <sup>(1)(2)</sup>

The following specifications apply for  $V_{DD} = 3.3V$  unless otherwise specified, limits apply to  $T_A = 25^\circ C$ .

Parameter		Test Conditions	LM4809		Units (Limits)
			Typ <sup>(3)</sup>	Limit <sup>(4)</sup>	
$I_{DD}$	Supply Current	$V_{IN} = 0V, I_O = 0A$	1.1		mA
$I_{SD}$	Shutdown Current	$V_{IN} = 0V, V_{SHUTDOWN} = GND$	0.4		$\mu A$
$V_{OS}$	Output Offset Voltage	$V_{IN} = 0V$	4.0		mV
$P_O$	Output Power	THD+N = 0.1%, f = 1kHz			
		$R_L = 16\Omega$	40		mW
		$R_L = 32\Omega$	28		mW
THD+N	Total Harmonic Distortion	$P_O = 25mW, R_L = 32\Omega$ f = 20Hz to 20kHz	0.4		%
Crosstalk	Channel Separation	$R_L = 32\Omega; P_O = 25mW$	70		dB
PSRR	Power Supply Rejection Ratio	$C_B = 1.0\mu F; V_{RIPPLE} = 200mV_{PP}$ , f = 1kHz; Input terminated into $50\Omega$	70		dB
$V_{SDIH}$	Shutdown Voltage Input High			$0.8 \times V_{DD}$	V (min)
$V_{SDIL}$	Shutdown Voltage Input Low			$0.2 \times V_{DD}$	V (max)

- (1) *Absolute Maximum Ratings* indicate limits beyond which damage to the device may occur.
- (2) All voltages are measured with respect to the ground pin, unless otherwise specified.
- (3) Typical specifications are specified at +25°C and represent the most likely parametric norm.
- (4) Datasheet min/max specification limits are ensured by design, test, or statistical analysis.

### Electrical Characteristics $V_{DD} = 2.6V$ <sup>(1)(2)</sup>

The following specifications apply for  $V_{DD} = 2.6V$  unless otherwise specified, limits apply to  $T_A = 25^\circ C$ .

Parameter		Test Conditions	LM4809		Units (Limits)
			Typ <sup>(3)</sup>	Limit <sup>(4)</sup>	
$I_{DD}$	Supply Current	$V_{IN} = 0V, I_O = 0A$	0.9		mA
$I_{SD}$	Shutdown Current	$V_{IN} = 0V, V_{SHUTDOWN} = GND$	0.2		$\mu A$
$V_{OS}$	Output Offset Voltage	$V_{IN} = 0V$	4.0		mV
$P_O$	Output Power	THD+N = 0.1%, f = 1kHz			
		$R_L = 16\Omega$	20		mW
		$R_L = 32\Omega$	16		mW
THD+N	Total Harmonic Distortion	$P_O = 15mW, R_L = 32\Omega$ f = 20Hz to 20kHz	0.6		%
Crosstalk	Channel Separation	$R_L = 32\Omega; P_O = 15mW$	70		dB
PSRR	Power Supply Rejection Ratio	$C_B = 1.0\mu F; V_{RIPPLE} = 200mV_{PP}$ , f = 1kHz; Input terminated into $50\Omega$	70		dB
$V_{SDIH}$	Shutdown Voltage Input High			$0.8 \times V_{DD}$	V (min)
$V_{SDIL}$	Shutdown Voltage Input Low			$0.2 \times V_{DD}$	V (max)

- (1) *Absolute Maximum Ratings* indicate limits beyond which damage to the device may occur.
- (2) All voltages are measured with respect to the ground pin, unless otherwise specified.
- (3) Typical specifications are specified at +25°C and represent the most likely parametric norm.
- (4) Datasheet min/max specification limits are ensured by design, test, or statistical analysis.

## External Components Description

Components	Functional Description (See <a href="#">Figure 1</a> )
1. $R_i$	The inverting input resistance, along with $R_f$ , set the closed-loop gain. $R_i$ , along with $C_i$ , form a high pass filter with $f_c = 1/(2\pi R_i C_i)$ .
2. $C_i$	The input coupling capacitor blocks DC voltage at the amplifier's input terminals. $C_i$ , along with $R_i$ , create a highpass filter with $f_c = 1/(2\pi R_i C_i)$ . Refer to the section, <a href="#">Selecting Proper External Components</a> , for an explanation of determining the value of $C_i$ .
3. $R_f$	The feedback resistance, along with $R_i$ , set closed-loop gain.
4. $C_S$	This is the supply bypass capacitor. It provides power supply filtering. Refer to the <a href="#">Application Information</a> section for proper placement and selection of the supply bypass capacitor.
5. $C_B$	This is the BYPASS pin capacitor. It provides half-supply filtering. Refer to the section, <a href="#">Selecting Proper External Components</a> , for information concerning proper placement and selection of $C_B$ .
6. $C_O$	This is the output coupling capacitor. It blocks the DC voltage at the amplifier's output and forms a high pass filter with $R_L$ at $f_o = 1/(2\pi R_L C_O)$

Typical Performance Characteristics

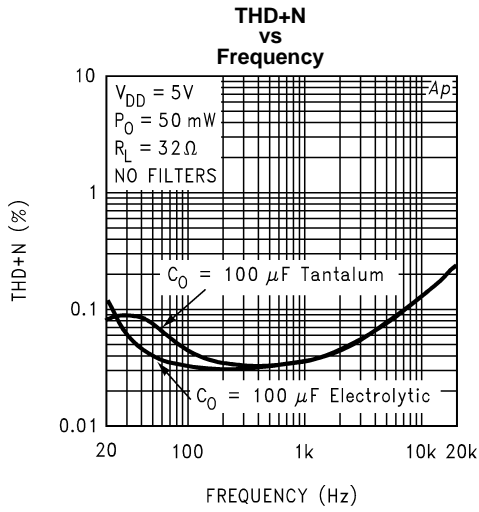

Figure 6.

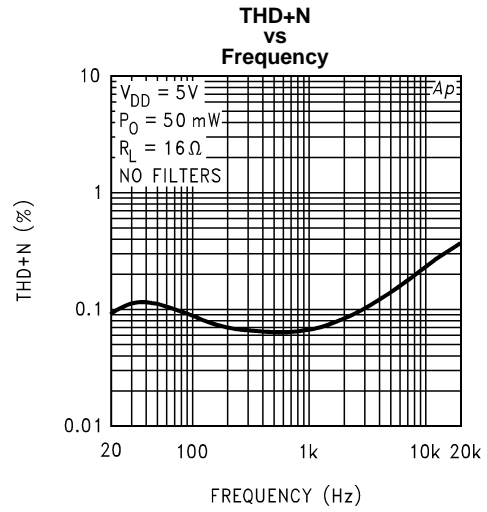

Figure 7.

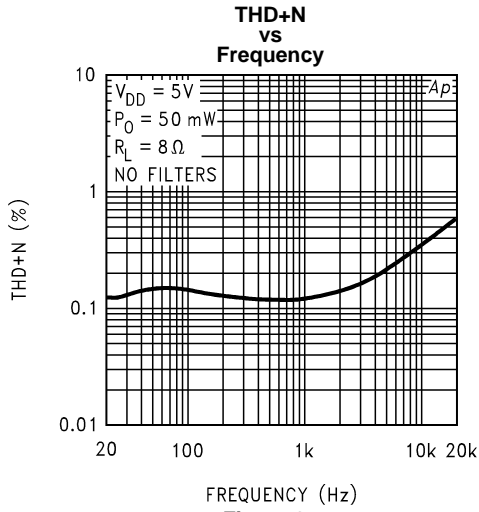

Figure 8.

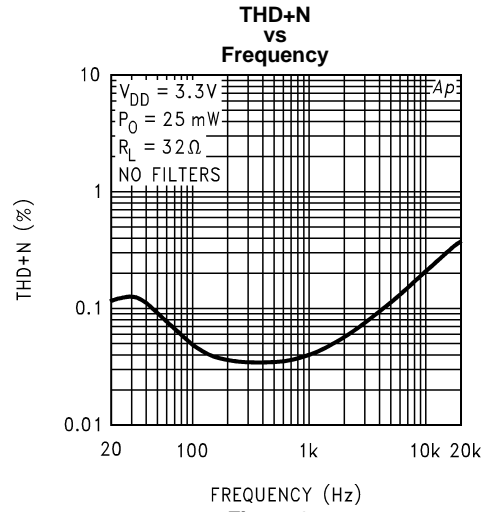

Figure 9.

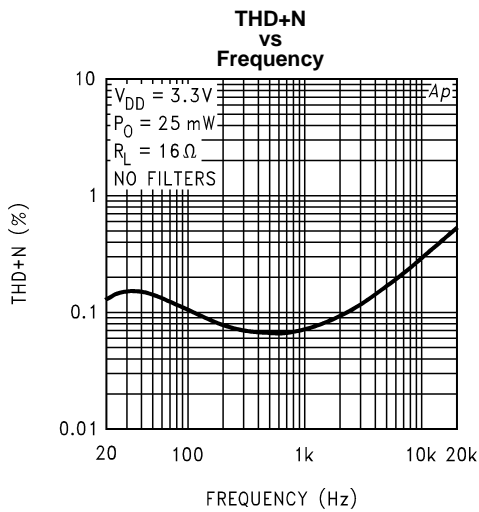

Figure 10.

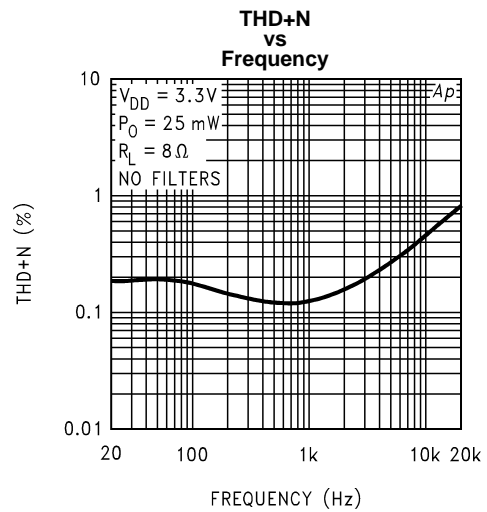

Figure 11.

**Typical Performance Characteristics (continued)**

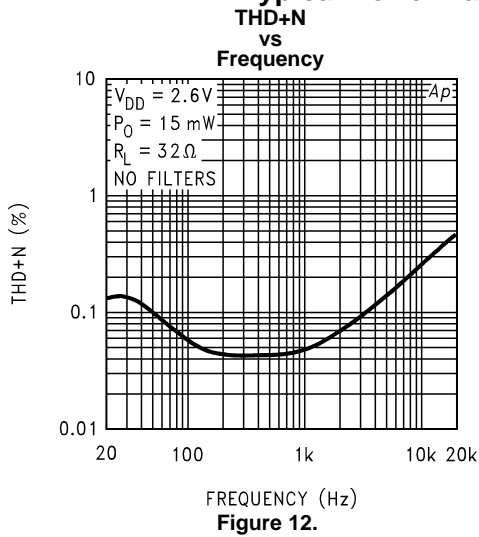

Figure 12.

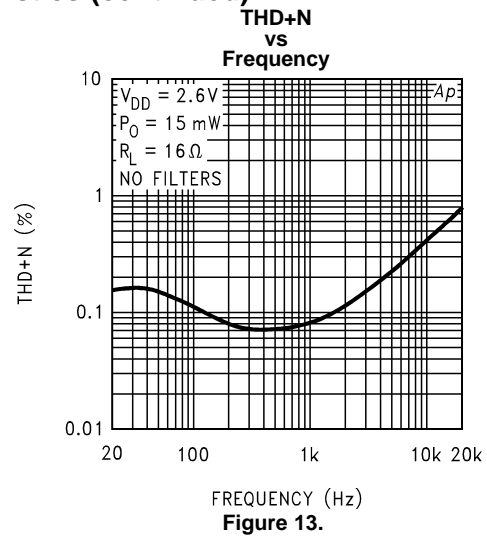

Figure 13.

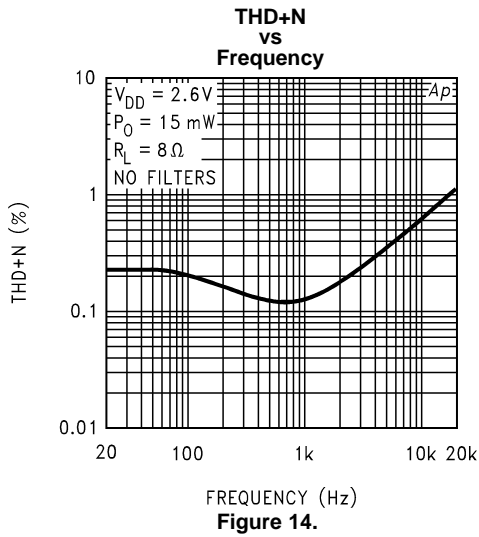

Figure 14.

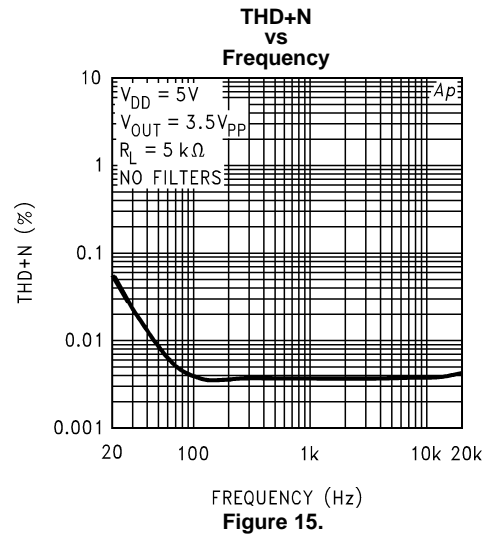

Figure 15.

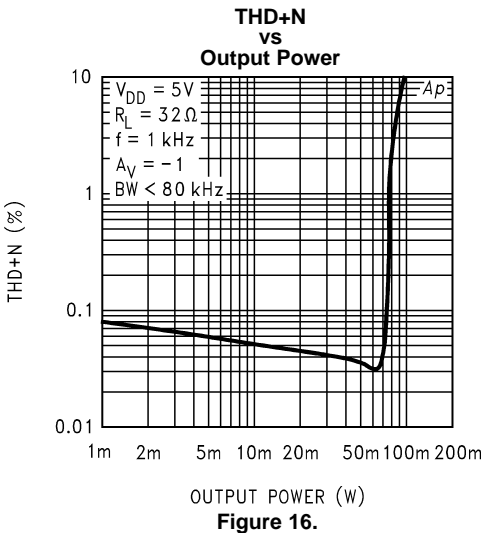

Figure 16.

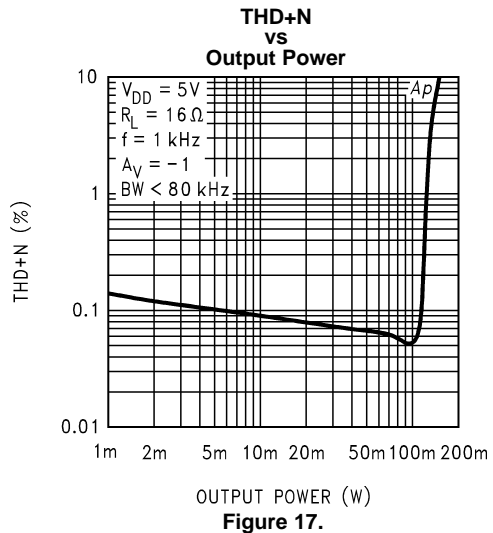

Figure 17.

Typical Performance Characteristics (continued)

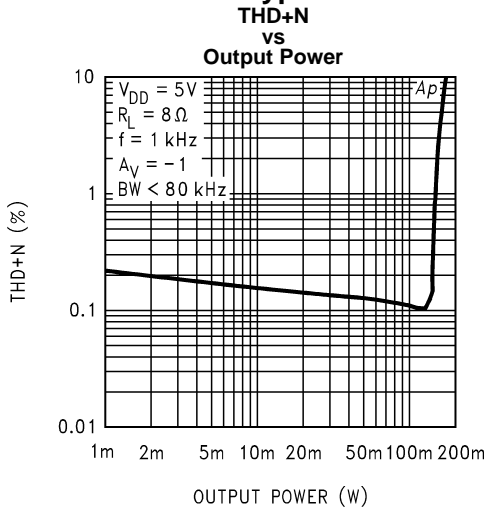

Figure 18.

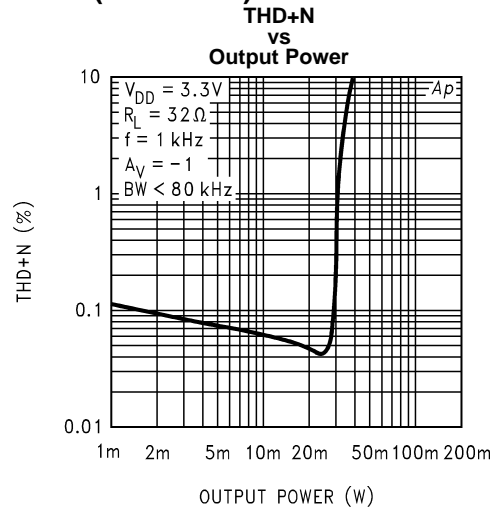

Figure 19.

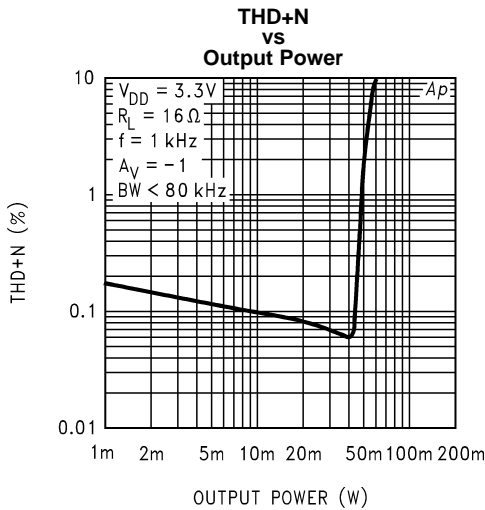

Figure 20.

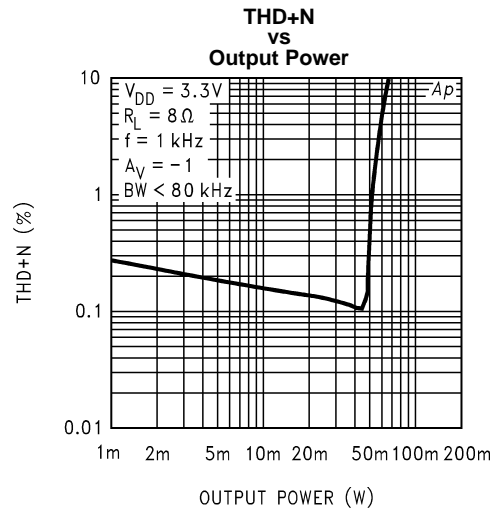

Figure 21.

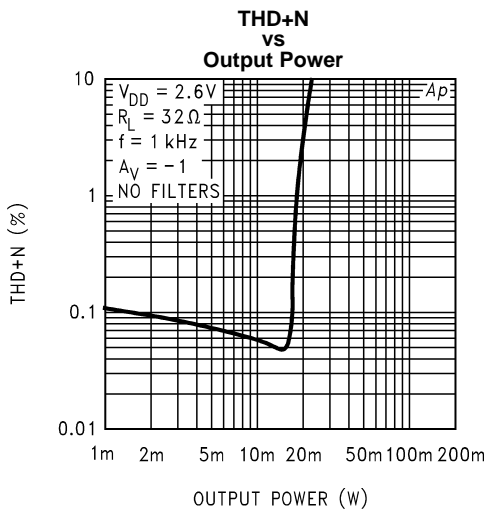

Figure 22.

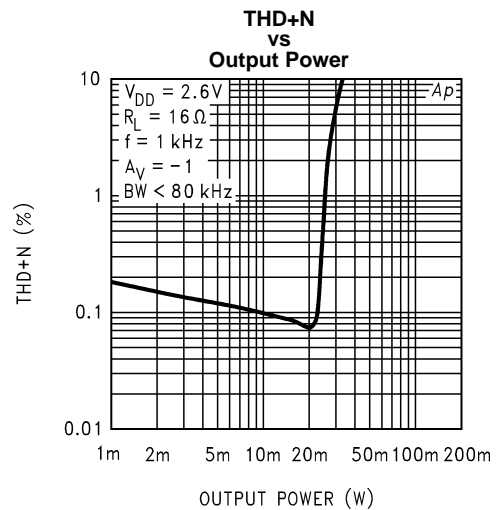
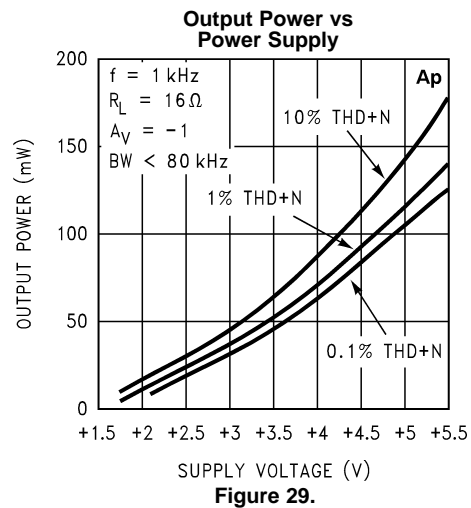
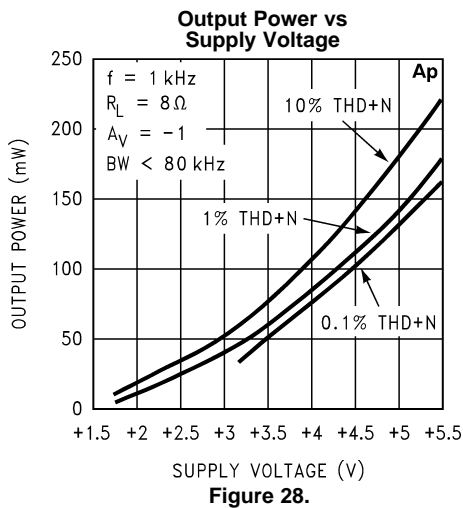
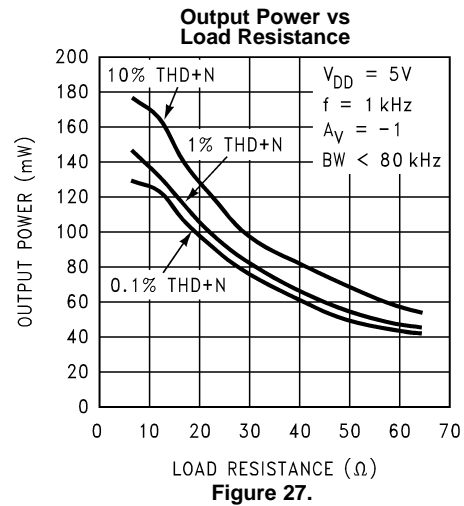
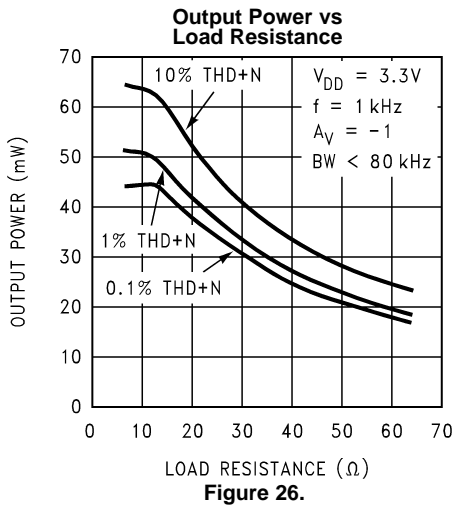
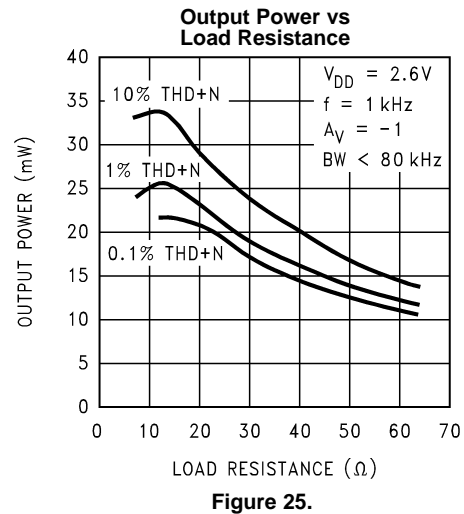
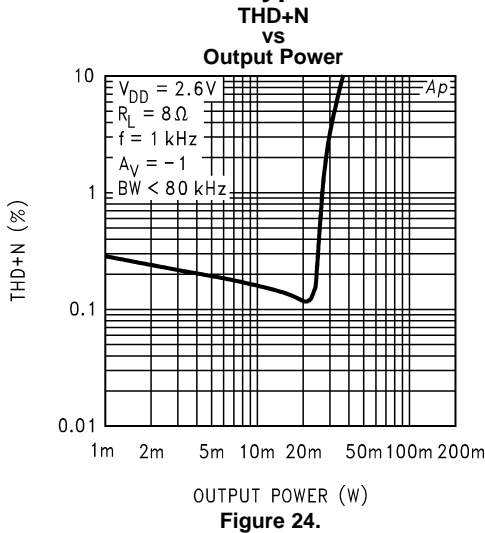

Figure 23.

**Typical Performance Characteristics (continued)**



Typical Performance Characteristics (continued)

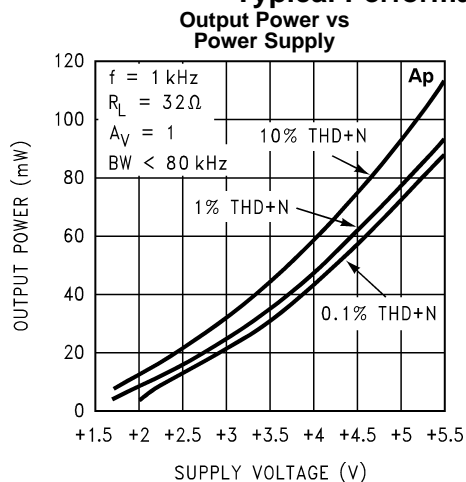

Figure 30.

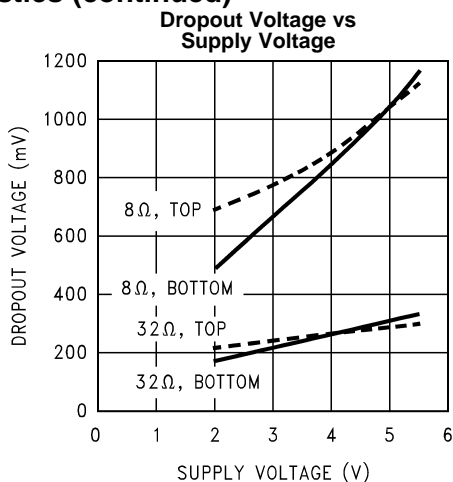

Figure 31.

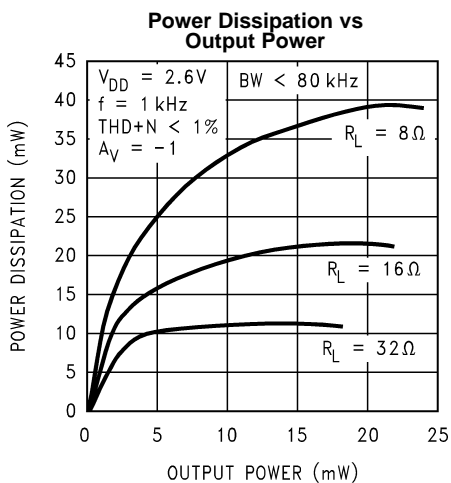

Figure 32.

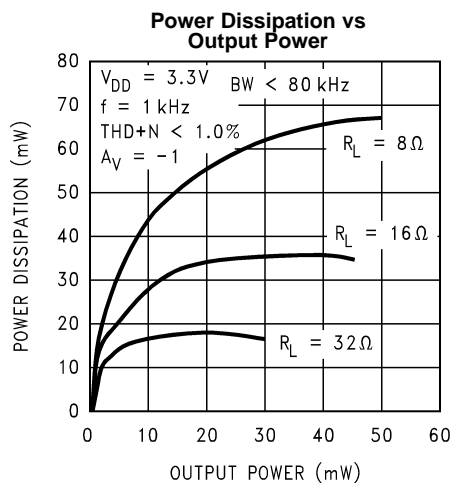

Figure 33.

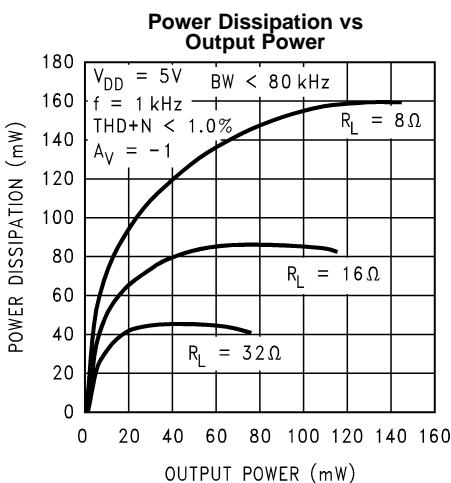

Figure 34.

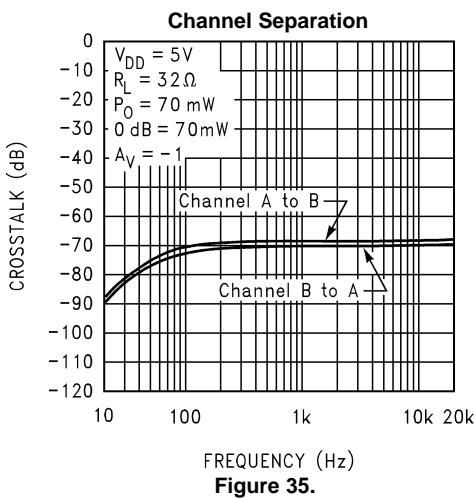

Figure 35.

Typical Performance Characteristics (continued)

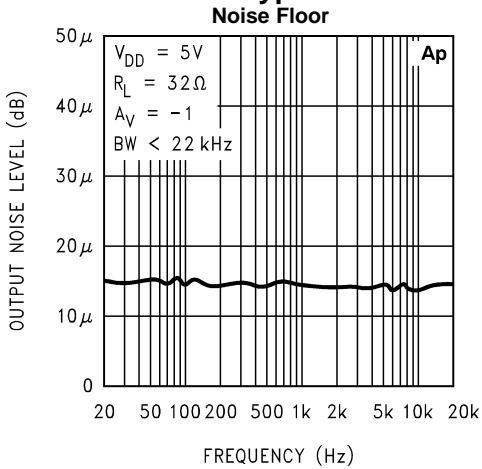

Figure 36.

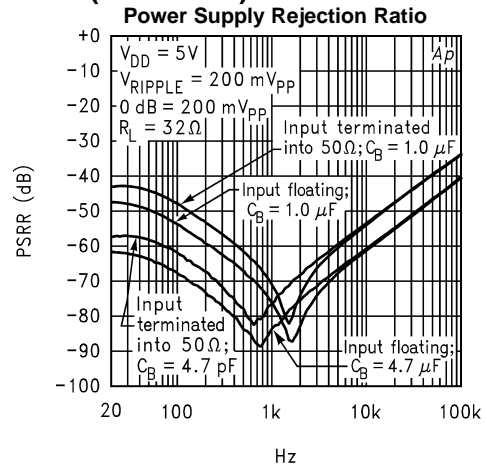

Figure 37.

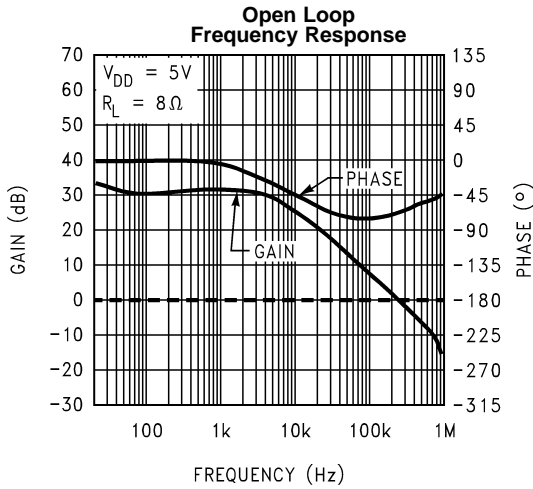

Figure 38.

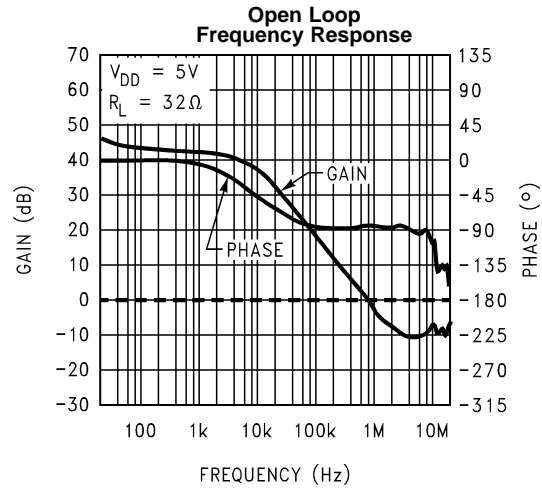

Figure 39.

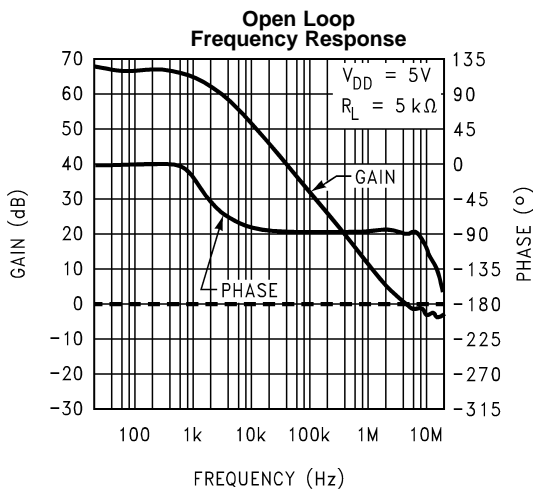

Figure 40.

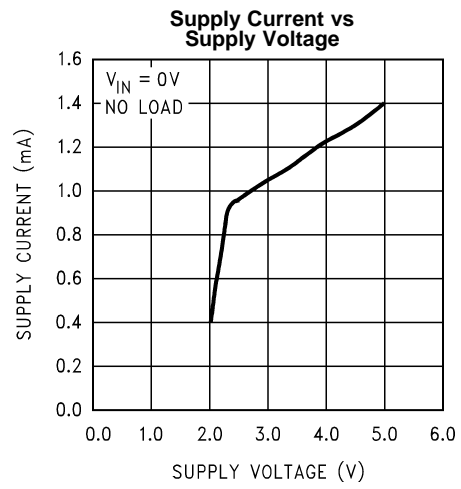

Figure 41.

## APPLICATION INFORMATION

### MICRO-POWER SHUTDOWN

The voltage applied to the SHUTDOWN pin controls the LM4809's shutdown function. Activate micro-power shutdown by applying a logic low voltage to the SHUTDOWN pin. The logic threshold is typically  $V_{DD}/2$ . When active, the LM4809's micro-power shutdown feature turns off the amplifier's bias circuitry, reducing the supply current. The low 0.4 $\mu$ A typical shutdown current is achieved by applying a voltage that is as near as GND as possible to the SHUTDOWN pin. A voltage that is above GND may increase the shutdown current.

There are a few ways to control the micro-power shutdown. These include using a single-pole, single-throw switch, a microprocessor, or a microcontroller. When using a switch, connect an external 100k $\Omega$  pull-down resistor between the SHUTDOWN pin and GND. Connect the switch between the SHUTDOWN pin and  $V_{DD}$ . Select normal amplifier operation by closing the switch. Opening the switch connects the SHUTDOWN pin to GND through the pull-down resistor, activating micro-power shutdown. The switch and resistor ensure that the SHUTDOWN pin will not float. This prevents unwanted state changes. In a system with a microprocessor or a microcontroller, use a digital output to apply the control voltage to the SHUTDOWN pin. Driving the SHUTDOWN pin with active circuitry eliminates the pull-down resistor.

### EXPOSED-DAP PACKAGE PCB MOUNTING CONSIDERATION

The LM4809's exposed-Dap (die attach paddle) package (LD or LQ) provides a low thermal resistance between the die and the PCB to which the part is mounted and soldered. This allows rapid heat transfer from the die to the surrounding PCB copper traces, ground plane, and surrounding air.

The LD or LQ package should have its DAP soldered to a copper pad on the PCB. The DAP's PCB copper pad may be connected to a large plane of continuous unbroken copper. This plane forms a thermal mass, heat sink, and radiation area.

However, since the LM4809 is designed for headphone applications, connecting a copper plane to the DAP's PCB copper pad is not required. [Figure 34](#) in [Typical Performance Characteristics](#) shows that the maximum power dissipated is just 45mW per amplifier with a 5V power supply and a 32 $\Omega$  load.

Further detailed and specific information concerning PCB layout, fabrication, and mounting an NGL0008B or NGP0008A package is available from Texas Instruments' Package Engineering Group under application note AN1187.

### POWER DISSIPATION

Power dissipation is a major concern when using any power amplifier and must be thoroughly understood to ensure a successful design. [Equation 1](#) states the maximum power dissipation point for a single-ended amplifier operating at a given supply voltage and driving a specified output load.

$$P_{DMAX} = (V_{DD})^2 / (2\pi^2 R_L) \quad (1)$$

Since the LM4809 has two operational amplifiers in one package, the maximum internal power dissipation point is twice that of the number which results from [Equation 1](#). Even with the large internal power dissipation, the LM4809 does not require heat sinking over a large range of ambient temperature. From [Equation 1](#), assuming a 5V power supply and a 32 $\Omega$  load, the maximum power dissipation point is 40mW per amplifier. Thus the maximum package dissipation point is 80mW. The maximum power dissipation point obtained must not be greater than the power dissipation that results from [Equation 2](#):

$$P_{DMAX} = (T_{JMAX} - T_A) / \theta_{JA} \quad (2)$$

For package MUA08A,  $\theta_{JA} = 210^{\circ}\text{C/W}$ .  $T_{JMAX} = 150^{\circ}\text{C}$  for the LM4809. Depending on the ambient temperature,  $T_A$ , of the system surroundings, [Equation 2](#) can be used to find the maximum internal power dissipation supported by the IC packaging. If the result of [Equation 1](#) is greater than that of [Equation 2](#), then either the supply voltage must be decreased, the load impedance increased or  $T_A$  reduced. For the typical application of a 5V power supply, with a  $32\Omega$  load, the maximum ambient temperature possible without violating the maximum junction temperature is approximately  $133.2^{\circ}\text{C}$  provided that device operation is around the maximum power dissipation point. Power dissipation is a function of output power and thus, if typical operation is not around the maximum power dissipation point, the ambient temperature may be increased accordingly. Refer to the [Typical Performance Characteristics](#) curves for power dissipation information for lower output powers.

## POWER SUPPLY BYPASSING

As with any power amplifier, proper supply bypassing is critical for low noise performance and high power supply rejection. Applications that employ a 5V regulator typically use a  $10\mu\text{F}$  in parallel with a  $0.1\mu\text{F}$  filter capacitors to stabilize the regulator's output, reduce noise on the supply line, and improve the supply's transient response. However, their presence does not eliminate the need for a local  $1.0\mu\text{F}$  tantalum bypass capacitance connected between the LM4809's supply pins and ground. Keep the length of leads and traces that connect capacitors between the LM4809's power supply pin and ground as short as possible. Connecting a  $4.7\mu\text{F}$  capacitor,  $C_B$ , between the BYPASS pin and ground improves the internal bias voltage's stability and improves the amplifier's PSRR. The PSRR improvements increase as the bypass pin capacitor value increases. Too large, however, increases the amplifier's turn-on time. The selection of bypass capacitor values, especially  $C_B$ , depends on desired PSRR requirements, click and pop performance (as explained in the section, [Selecting Proper External Components](#)), system cost, and size constraints.

## SELECTING PROPER EXTERNAL COMPONENTS

Optimizing the LM4809's performance requires properly selecting external components. Though the LM4809 operates well when using external components with wide tolerances, best performance is achieved by optimizing component values.

The LM4809 is unity-gain stable, giving a designer maximum design flexibility. The gain should be set to no more than a given application requires. This allows the amplifier to achieve minimum THD+N and maximum signal-to-noise ratio. These parameters are compromised as the closed-loop gain increases. However, low gain demands input signals with greater voltage swings to achieve maximum output power. Fortunately, many signal sources such as audio CODECs have outputs of  $1V_{RMS}$  ( $2.83V_{P-P}$ ). Please refer to the [Audio Power Amplifier Design](#) section for more information on selecting the proper gain.

### Input and Output Capacitor Value Selection

Amplifying the lowest audio frequencies requires high value input and output coupling capacitors ( $C_I$  and  $C_O$  in [Figure 1](#)). A high value capacitor can be expensive and may compromise space efficiency in portable designs. In many cases, however, the speakers used in portable systems, whether internal or external, have little ability to reproduce signals below 150Hz. Applications using speakers with this limited frequency response reap little improvement by using high value input and output capacitors.

Besides affecting system cost and size,  $C_I$  has an effect on the LM4809's click and pop performance. The magnitude of the pop is directly proportional to the input capacitor's size. Thus, pops can be minimized by selecting an input capacitor value that is no higher than necessary to meet the desired  $-3\text{dB}$  frequency. Please refer to the [Optimizing Click and Pop Reduction Performance](#) section for a more detailed discussion on click and pop performance.

As shown in [Figure 1](#), the input resistor,  $R_I$  and the input capacitor,  $C_I$ , produce a  $-3\text{dB}$  high pass filter cutoff frequency that is found using [Equation 3](#). In addition, the output load  $R_L$ , and the output capacitor  $C_O$ , produce a  $-3\text{dB}$  high pass filter cutoff frequency defined by [Equation 4](#).

$$f_{i-3db} = 1/2\pi R_I C_I \quad (3)$$

$$f_{o-3db} = 1/2\pi R_L C_O \quad (4)$$

Also, careful consideration must be taken in selecting a certain type of capacitor to be used in the system. Different types of capacitors (tantalum, electrolytic, ceramic) have unique performance characteristics and may affect overall system performance.

### Bypass Capacitor Value Selection

Besides minimizing the input capacitor size, careful consideration should be paid to the value of  $C_B$ , the capacitor connected to the BYPASS pin. Since  $C_B$  determines how fast the LM4809 settles to quiescent operation, its value is critical when minimizing turn-on pops. The slower the LM4809's outputs ramp to their quiescent DC voltage (nominally  $1/2 V_{DD}$ ), the smaller the turn-on pop. Choosing  $C_B$  equal to  $4.7\mu\text{F}$  along with a small value of  $C_i$  (in the range of  $0.1\mu\text{F}$  to  $0.47\mu\text{F}$ ), produces a click-less and pop-less shutdown function. As discussed above, choosing  $C_i$  no larger than necessary for the desired bandwidth helps minimize clicks and pops.

### OPTIMIZING CLICK AND POP REDUCTION PERFORMANCE

The LM4809 contains circuitry that minimizes turn-on and shutdown transients or “clicks and pop”. For this discussion, turn-on refers to either applying the power supply voltage or when the shutdown mode is deactivated. During turn-on, the LM4809's internal amplifiers are configured as unity gain buffers. An internal current source charges up the capacitor on the BYPASS pin in a controlled, linear manner. The gain of the internal amplifiers remains unity until the voltage on the BYPASS pin reaches  $1/2 V_{DD}$ . As soon as the voltage on the BYPASS pin is stable, the device becomes fully operational. During device turn-on, a transient (pop) is created from a voltage difference between the input and output of the amplifier as the voltage on the BYPASS pin reaches  $1/2 V_{DD}$ . For this discussion, the input of the amplifier refers to the node between  $R_i$  and  $C_i$ . Ideally, the input and output track the voltage applied to the BYPASS pin. During turn-on, the buffer-configured amplifier output charges the input capacitor,  $C_i$ , through the input resistor,  $R_i$ . This input resistor delays the charging time of  $C_i$  thereby causing the voltage difference between the input and output that results in a transient (pop). Higher value capacitors need more time to reach a quiescent DC voltage (usually  $1/2 V_{DD}$ ) when charged with a fixed current. Decreasing the value of  $C_i$  and  $R_i$  will minimize turn-on pops at the expense of the desired -3dB frequency.

Although the BYPASS pin current cannot be modified, changing the size of  $C_B$  alters the device's turn-on time and the magnitude of “clicks and pops”. Increasing the value of  $C_B$  reduces the magnitude of turn-on pops. However, this presents a tradeoff: as the size of  $C_B$  increases, the turn-on time increases. There is a linear relationship between the size of  $C_B$  and the turn-on time. Here are some typical turn-on times for various values of  $C_B$ :

$C_B$	$T_{ON}$
0.1 $\mu\text{F}$	80ms
0.22 $\mu\text{F}$	170ms
0.33 $\mu\text{F}$	270ms
0.47 $\mu\text{F}$	370ms
0.68 $\mu\text{F}$	490ms
1.0 $\mu\text{F}$	920ms
2.2 $\mu\text{F}$	1.8sec
3.3 $\mu\text{F}$	2.8sec
4.7 $\mu\text{F}$	3.4sec
10 $\mu\text{F}$	7.7sec

In order eliminate “clicks and pops”, all capacitors must be discharged before turn-on. Rapidly switching  $V_{DD}$  may not allow the capacitors to fully discharge, which may cause “clicks and pops”. In a single-ended configuration, the output is coupled to the load by  $C_O$ . This capacitor usually has a high value.  $C_O$  discharges through internal 20k $\Omega$  resistors. Depending on the size of  $C_O$ , the discharge time constant can be relatively large. To reduce transients in single-ended mode, an external 1k $\Omega$ –5k $\Omega$  resistor can be placed in parallel with the internal 20k $\Omega$  resistor. The tradeoff for using this resistor is increased quiescent current.

## AUDIO POWER AMPLIFIER DESIGN

### Design a Dual 70mW/32Ω Audio Amplifier

Given:	
Power Output	70 mW
Load Impedance	32Ω
Input Level	1 V <sub>rms</sub> (max)
Input Impedance	20kΩ
Bandwidth	100 Hz–20 kHz ± 0.50dB

The design begins by specifying the minimum supply voltage necessary to obtain the specified output power. One way to find the minimum supply voltage is to use [Figure 28](#) in the [Typical Performance Characteristics](#) section. Another way, using [Equation 5](#), is to calculate the peak output voltage necessary to achieve the desired output power for a given load impedance. To account for the amplifier's dropout voltage, two additional voltages, based on [Figure 31](#) in [Typical Performance Characteristics](#), must be added to the result obtained by [Equation 5](#). For a single-ended application, the result is [Equation 6](#).

$$V_{\text{opeak}} = \sqrt{2R_L P_O} \quad (5)$$

$$V_{DD} \geq (2V_{\text{OPEAK}} + (V_{\text{ODTOP}} + V_{\text{ODBOT}})) \quad (6)$$

[Figure 28](#) for a 32Ω load indicates a minimum supply voltage of 4.8V. This is easily met by the commonly used 5V supply voltage. The additional voltage creates the benefit of headroom, allowing the LM4809 to produce peak output power in excess of 70mW without clipping or other audible distortion. The choice of supply voltage must also not create a situation that violates maximum power dissipation as explained above in the [Power Dissipation](#) section. Remember that the maximum power dissipation point from [Equation 1](#) must be multiplied by two since there are two independent amplifiers inside the package. Once the power dissipation equations have been addressed, the required gain can be determined from [Equation 7](#).

$$A_V \geq \sqrt{P_O R_L} / (V_{IN}) = V_{\text{orms}} / V_{\text{inrms}} \quad (7)$$

Thus, a minimum gain of 1.497 allows the LM4809 to reach full output swing and maintain low noise and THD+N performance. For this example, let  $A_V=1.5$ .

The amplifiers overall gain is set using the input ( $R_i$ ) and feedback ( $R_f$ ) resistors. With the desired input impedance set at 20kΩ, the feedback resistor is found using [Equation 8](#).

$$A_V = R_f / R_i \quad (8)$$

The value of  $R_f$  is 30kΩ.

The last step in this design is setting the amplifier's -3db frequency bandwidth. To achieve the desired  $\pm 0.25\text{dB}$  pass band magnitude variation limit, the low frequency response must extend to at least one-fifth the lower bandwidth limit and the high frequency response must extend to at least five times the upper bandwidth limit. The gain variation for both response limits is 0.17dB, well within the  $\pm 0.25\text{dB}$  desired limit. The results are an

$$f_L = 100\text{Hz}/5 = 20\text{Hz} \quad (9)$$

and a

$$f_H = 20\text{kHz} \cdot 5 = 100\text{kHz} \quad (10)$$

As stated in the [Selecting Proper External Components](#) section, both  $R_i$  in conjunction with  $C_i$ , and  $C_o$  with  $R_L$ , create first order highpass filters. Thus to obtain the desired low frequency response of 100Hz within  $\pm 0.5\text{dB}$ , both poles must be taken into consideration. The combination of two single order filters at the same frequency forms a second order response. This results in a signal which is down 0.34dB at five times away from the single order filter -3dB point. Thus, a frequency of 20Hz is used in the following equations to ensure that the response is better than 0.5dB down at 100Hz.

$$C_i \geq 1 / (2\pi \cdot 20\text{k}\Omega \cdot 20\text{Hz}) = 0.397\mu\text{F}; \text{ use } 0.39\mu\text{F}. \quad (11)$$

$$C_o \geq 1 / (2\pi \cdot 32\Omega \cdot 20\text{Hz}) = 249\mu\text{F}; \text{ use } 330\mu\text{F}. \quad (12)$$

The high frequency pole is determined by the product of the desired high frequency pole,  $f_H$ , and the closed-loop gain,  $A_V$ . With a closed-loop gain of 1.5 and  $f_H = 100\text{kHz}$ , the resulting GBWP = 150kHz which is much smaller than the LM4809's GBWP of 900kHz. This figure displays that if a designer has a need to design an amplifier with a higher gain, the LM4809 can still be used without running into bandwidth limitations.

Demonstration Board Schematic

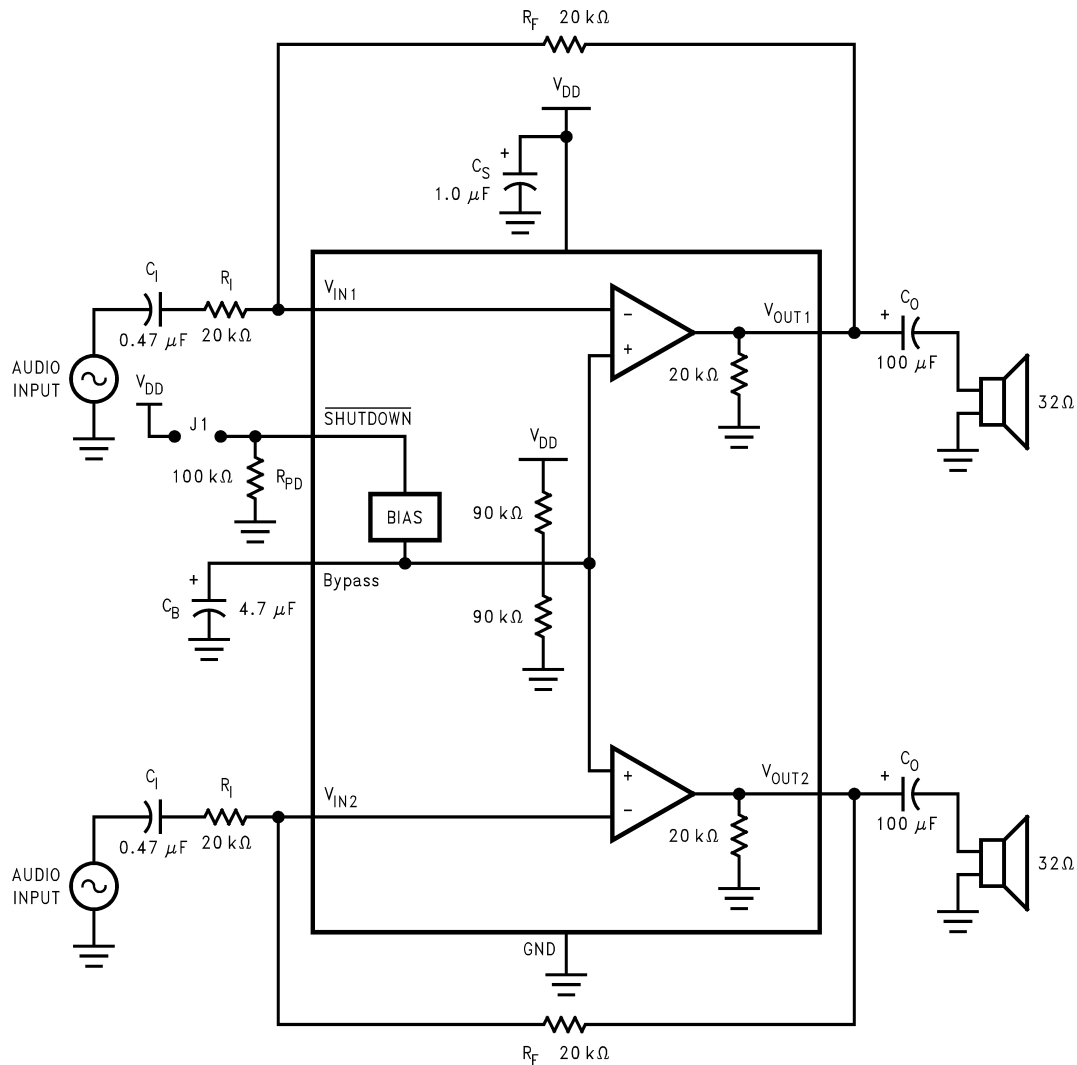

Figure 42. LM4809 Demonstration Board Schematic

Demonstration Board Layout

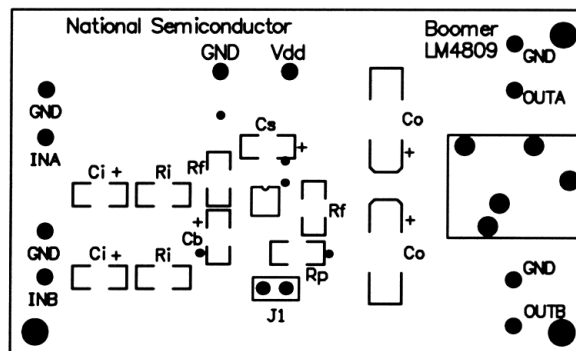

Figure 43. Recommended DGK008A PC Board Layout Component-Side Silkscreen

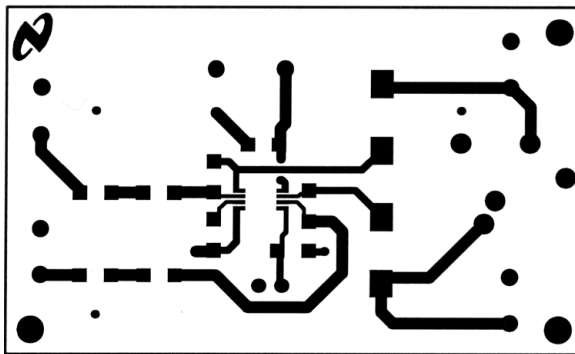

Figure 44. Recommended DGK0008A PC Board Layout Component-Side Layout

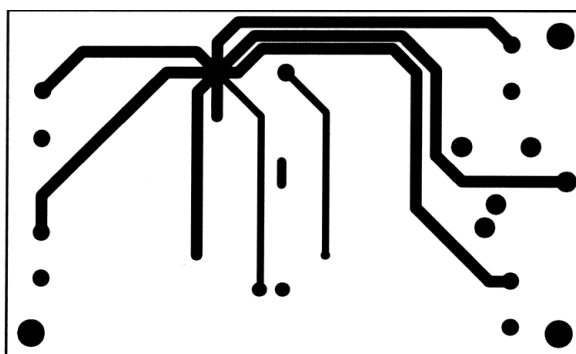

Figure 45. Recommended DGK0008A PC Board Layout Bottom-Side Layout

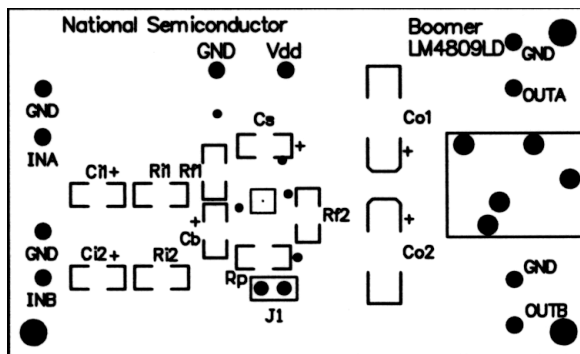

Figure 46. Recommended NGL0008B PC Board Layout Component-Side Silkscreen

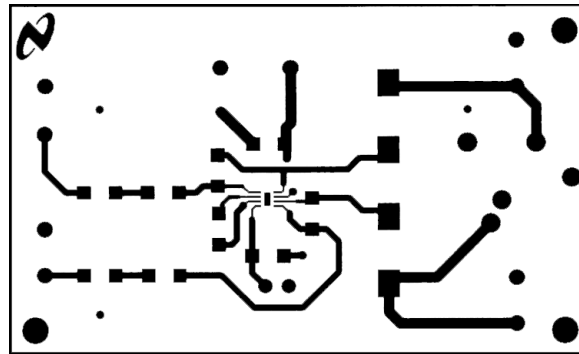

Figure 47. Recommended NGL0008B PC Board Layout Component-Side Layout

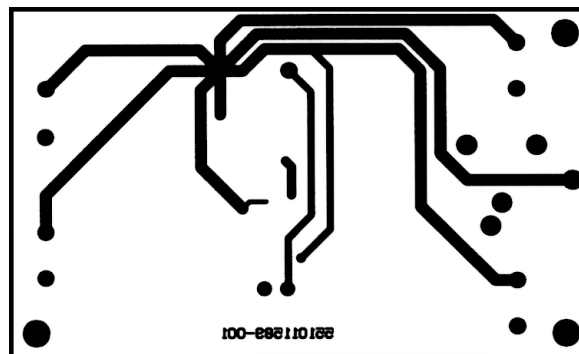

Figure 48. Recommended NGL0008B PC Board Layout Bottom-Side Layout

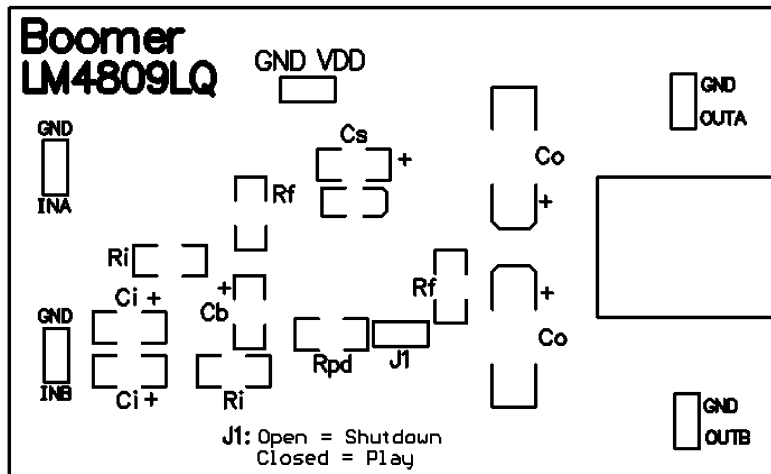

Figure 49. Recommended NGP0008A PC Board Layout Component-Side Silkscreen

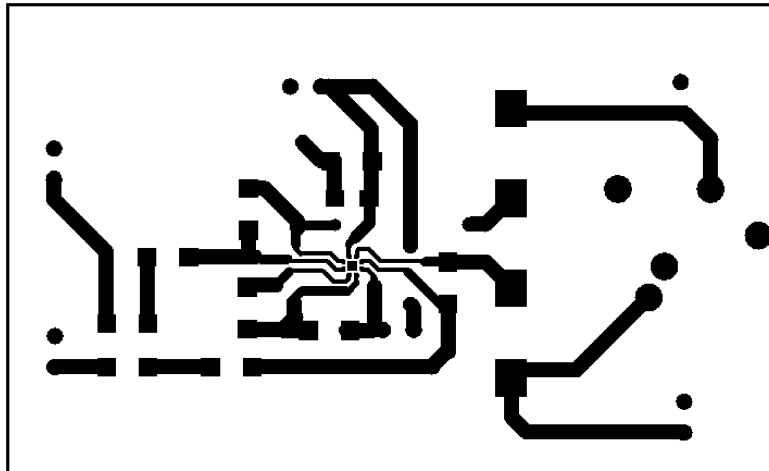

Figure 50. Recommended NGP008A PC Board Layout  
Component-Side Layout

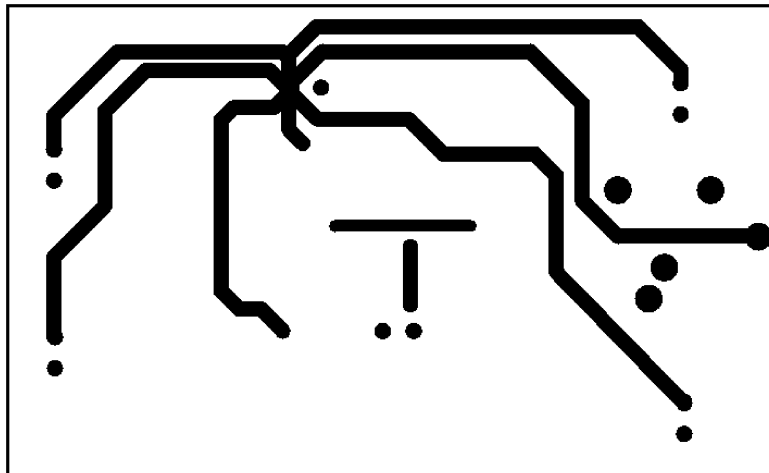

Figure 51. Recommended NGP008A PC Board Layout  
Bottom-Side Layout

## REVISION HISTORY

Changes from Revision E (April 2013) to Revision F	Page
• Changed layout of National Data Sheet to TI format .....	<a href="#">21</a>

**PACKAGING INFORMATION**

Orderable Device	Status (1)	Package Type	Package Drawing	Pins	Package Qty	Eco Plan (2)	Lead/Ball Finish	MSL Peak Temp (3)	Op Temp (°C)	Device Marking (4/5)	Samples
LM4809LDX/NOPB	ACTIVE	WSO8	NGL	8	4500	Green (RoHS & no Sb/Br)	CU SN	Level-3-260C-168 HR	-40 to 85	G09	<a href="#">Samples</a>
LM4809MM/NOPB	ACTIVE	VSSOP	DGK	8	1000	Green (RoHS & no Sb/Br)	CU SN	Level-1-260C-UNLIM	-40 to 85	G09	<a href="#">Samples</a>
LM4809MMX/NOPB	ACTIVE	VSSOP	DGK	8	3500	Green (RoHS & no Sb/Br)	CU SN	Level-1-260C-UNLIM	-40 to 85	G09	<a href="#">Samples</a>

(1) The marketing status values are defined as follows:

**ACTIVE:** Product device recommended for new designs.

**LIFEBUY:** TI has announced that the device will be discontinued, and a lifetime-buy period is in effect.

**NRND:** Not recommended for new designs. Device is in production to support existing customers, but TI does not recommend using this part in a new design.

**PREVIEW:** Device has been announced but is not in production. Samples may or may not be available.

**OBSELETE:** TI has discontinued the production of the device.

(2) Eco Plan - The planned eco-friendly classification: Pb-Free (RoHS), Pb-Free (RoHS Exempt), or Green (RoHS & no Sb/Br) - please check <http://www.ti.com/productcontent> for the latest availability information and additional product content details.

**TBD:** The Pb-Free/Green conversion plan has not been defined.

**Pb-Free (RoHS):** TI's terms "Lead-Free" or "Pb-Free" mean semiconductor products that are compatible with the current RoHS requirements for all 6 substances, including the requirement that lead not exceed 0.1% by weight in homogeneous materials. Where designed to be soldered at high temperatures, TI Pb-Free products are suitable for use in specified lead-free processes.

**Pb-Free (RoHS Exempt):** This component has a RoHS exemption for either 1) lead-based flip-chip solder bumps used between the die and package, or 2) lead-based die adhesive used between the die and leadframe. The component is otherwise considered Pb-Free (RoHS compatible) as defined above.

**Green (RoHS & no Sb/Br):** TI defines "Green" to mean Pb-Free (RoHS compatible), and free of Bromine (Br) and Antimony (Sb) based flame retardants (Br or Sb do not exceed 0.1% by weight in homogeneous material)

(3) MSL, Peak Temp. -- The Moisture Sensitivity Level rating according to the JEDEC industry standard classifications, and peak solder temperature.

(4) There may be additional marking, which relates to the logo, the lot trace code information, or the environmental category on the device.

(5) Multiple Device Markings will be inside parentheses. Only one Device Marking contained in parentheses and separated by a "~" will appear on a device. If a line is indented then it is a continuation of the previous line and the two combined represent the entire Device Marking for that device.

**Important Information and Disclaimer:**The information provided on this page represents TI's knowledge and belief as of the date that it is provided. TI bases its knowledge and belief on information provided by third parties, and makes no representation or warranty as to the accuracy of such information. Efforts are underway to better integrate information from third parties. TI has taken and continues to take reasonable steps to provide representative and accurate information but may not have conducted destructive testing or chemical analysis on incoming materials and chemicals. TI and TI suppliers consider certain information to be proprietary, and thus CAS numbers and other limited information may not be available for release.

In no event shall TI's liability arising out of such information exceed the total purchase price of the TI part(s) at issue in this document sold by TI to Customer on an annual basis.

## TAPE AND REEL INFORMATION



### QUADRANT ASSIGNMENTS FOR PIN 1 ORIENTATION IN TAPE



\*All dimensions are nominal

Device	Package Type	Package Drawing	Pins	SPQ	Reel Diameter (mm)	Reel Width W1 (mm)	A0 (mm)	B0 (mm)	K0 (mm)	P1 (mm)	W (mm)	Pin1 Quadrant
LM4809LDX/NOPB	WSON	NGL	8	4500	330.0	12.4	2.8	2.8	1.0	8.0	12.0	Q1
LM4809MM/NOPB	VSSOP	DGK	8	1000	178.0	12.4	5.3	3.4	1.4	8.0	12.0	Q1
LM4809MMX/NOPB	VSSOP	DGK	8	3500	330.0	12.4	5.3	3.4	1.4	8.0	12.0	Q1

**TAPE AND REEL BOX DIMENSIONS**



\*All dimensions are nominal

Device	Package Type	Package Drawing	Pins	SPQ	Length (mm)	Width (mm)	Height (mm)
LM4809LDX/NOPB	WSON	NGL	8	4500	367.0	367.0	35.0
LM4809MM/NOPB	VSSOP	DGK	8	1000	210.0	185.0	35.0
LM4809MMX/NOPB	VSSOP	DGK	8	3500	367.0	367.0	35.0

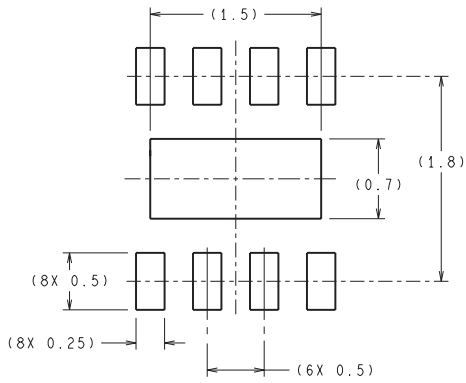
NGL0008B

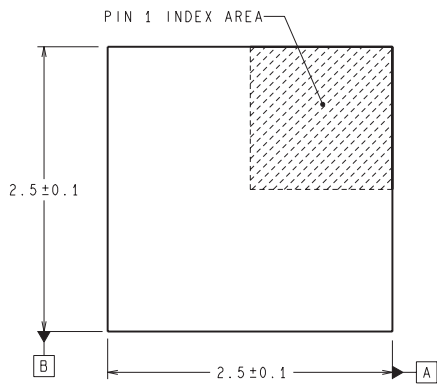

**RECOMMENDED LAND PATTERN**  
1:1 RATIO WITH PKG SOLDER PADS



**DIMENSIONS ARE IN MILLIMETERS**  
DIMENSIONS IN ( ) FOR REFERENCE ONLY

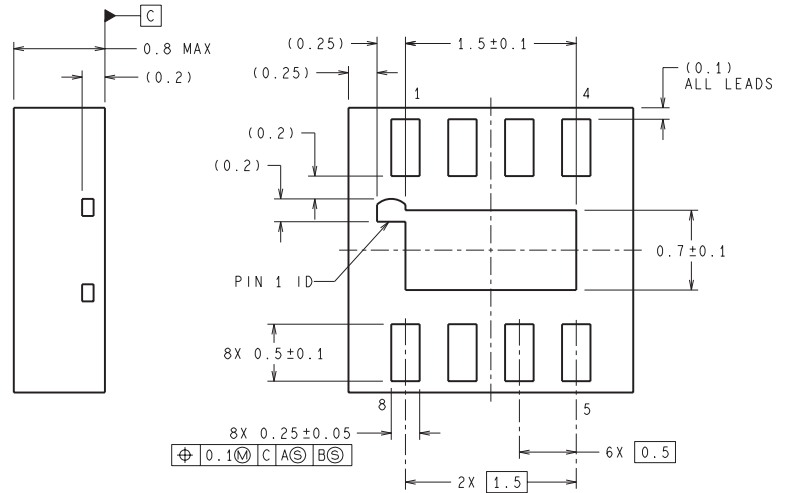

LDA08B (Rev B)

DGK (S-PDSO-G8)

PLASTIC SMALL-OUTLINE PACKAGE

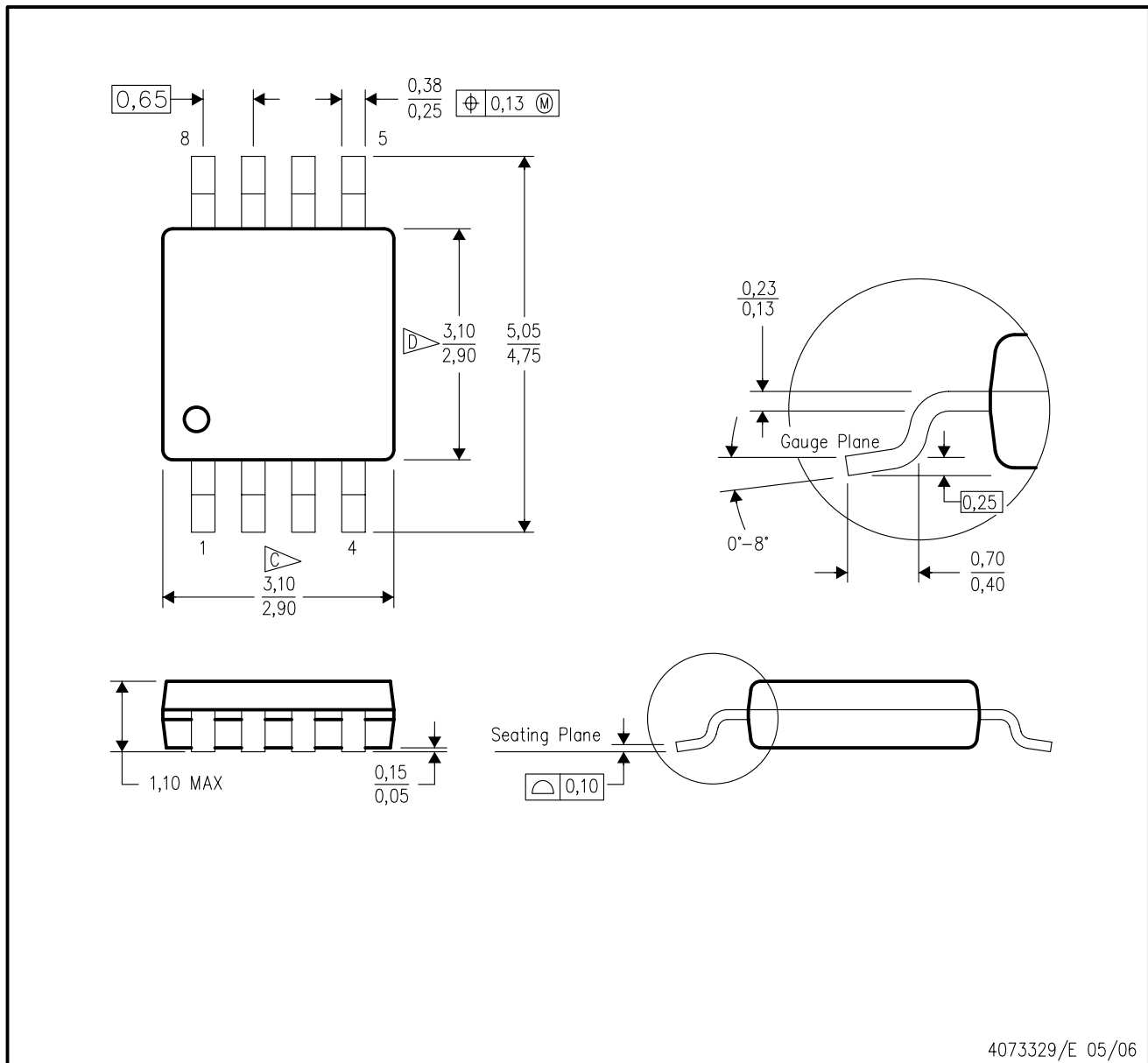

- NOTES:
- A. All linear dimensions are in millimeters.
  - B. This drawing is subject to change without notice.
  - C. Body length does not include mold flash, protrusions, or gate burrs. Mold flash, protrusions, or gate burrs shall not exceed 0.15 per end.
  - D. Body width does not include interlead flash. Interlead flash shall not exceed 0.50 per side.
  - E. Falls within JEDEC MO-187 variation AA, except interlead flash.



- NOTES:
- A. All linear dimensions are in millimeters.
  - B. This drawing is subject to change without notice.
  - C. Publication IPC-7351 is recommended for alternate designs.
  - D. Laser cutting apertures with trapezoidal walls and also rounding corners will offer better paste release. Customers should contact their board assembly site for stencil design recommendations. Refer to IPC-7525 for other stencil recommendations.
  - E. Customers should contact their board fabrication site for solder mask tolerances between and around signal pads.

## IMPORTANT NOTICE

Texas Instruments Incorporated (TI) reserves the right to make corrections, enhancements, improvements and other changes to its semiconductor products and services per JESD46, latest issue, and to discontinue any product or service per JESD48, latest issue. Buyers should obtain the latest relevant information before placing orders and should verify that such information is current and complete.

TI's published terms of sale for semiconductor products (<http://www.ti.com/sc/docs/stdterms.htm>) apply to the sale of packaged integrated circuit products that TI has qualified and released to market. Additional terms may apply to the use or sale of other types of TI products and services.

Reproduction of significant portions of TI information in TI data sheets is permissible only if reproduction is without alteration and is accompanied by all associated warranties, conditions, limitations, and notices. TI is not responsible or liable for such reproduced documentation. Information of third parties may be subject to additional restrictions. Resale of TI products or services with statements different from or beyond the parameters stated by TI for that product or service voids all express and any implied warranties for the associated TI product or service and is an unfair and deceptive business practice. TI is not responsible or liable for any such statements.

Buyers and others who are developing systems that incorporate TI products (collectively, "Designers") understand and agree that Designers remain responsible for using their independent analysis, evaluation and judgment in designing their applications and that Designers have full and exclusive responsibility to assure the safety of Designers' applications and compliance of their applications (and of all TI products used in or for Designers' applications) with all applicable regulations, laws and other applicable requirements. Designer represents that, with respect to their applications, Designer has all the necessary expertise to create and implement safeguards that (1) anticipate dangerous consequences of failures, (2) monitor failures and their consequences, and (3) lessen the likelihood of failures that might cause harm and take appropriate actions. Designer agrees that prior to using or distributing any applications that include TI products, Designer will thoroughly test such applications and the functionality of such TI products as used in such applications.

TI's provision of technical, application or other design advice, quality characterization, reliability data or other services or information, including, but not limited to, reference designs and materials relating to evaluation modules, (collectively, "TI Resources") are intended to assist designers who are developing applications that incorporate TI products; by downloading, accessing or using TI Resources in any way, Designer (individually or, if Designer is acting on behalf of a company, Designer's company) agrees to use any particular TI Resource solely for this purpose and subject to the terms of this Notice.

TI's provision of TI Resources does not expand or otherwise alter TI's applicable published warranties or warranty disclaimers for TI products, and no additional obligations or liabilities arise from TI providing such TI Resources. TI reserves the right to make corrections, enhancements, improvements and other changes to its TI Resources. TI has not conducted any testing other than that specifically described in the published documentation for a particular TI Resource.

Designer is authorized to use, copy and modify any individual TI Resource only in connection with the development of applications that include the TI product(s) identified in such TI Resource. NO OTHER LICENSE, EXPRESS OR IMPLIED, BY ESTOPPEL OR OTHERWISE TO ANY OTHER TI INTELLECTUAL PROPERTY RIGHT, AND NO LICENSE TO ANY TECHNOLOGY OR INTELLECTUAL PROPERTY RIGHT OF TI OR ANY THIRD PARTY IS GRANTED HEREIN, including but not limited to any patent right, copyright, mask work right, or other intellectual property right relating to any combination, machine, or process in which TI products or services are used. Information regarding or referencing third-party products or services does not constitute a license to use such products or services, or a warranty or endorsement thereof. Use of TI Resources may require a license from a third party under the patents or other intellectual property of the third party, or a license from TI under the patents or other intellectual property of TI.

TI RESOURCES ARE PROVIDED "AS IS" AND WITH ALL FAULTS. TI DISCLAIMS ALL OTHER WARRANTIES OR REPRESENTATIONS, EXPRESS OR IMPLIED, REGARDING RESOURCES OR USE THEREOF, INCLUDING BUT NOT LIMITED TO ACCURACY OR COMPLETENESS, TITLE, ANY EPIDEMIC FAILURE WARRANTY AND ANY IMPLIED WARRANTIES OF MERCHANTABILITY, FITNESS FOR A PARTICULAR PURPOSE, AND NON-INFRINGEMENT OF ANY THIRD PARTY INTELLECTUAL PROPERTY RIGHTS. TI SHALL NOT BE LIABLE FOR AND SHALL NOT DEFEND OR INDEMNIFY DESIGNER AGAINST ANY CLAIM, INCLUDING BUT NOT LIMITED TO ANY INFRINGEMENT CLAIM THAT RELATES TO OR IS BASED ON ANY COMBINATION OF PRODUCTS EVEN IF DESCRIBED IN TI RESOURCES OR OTHERWISE. IN NO EVENT SHALL TI BE LIABLE FOR ANY ACTUAL, DIRECT, SPECIAL, COLLATERAL, INDIRECT, PUNITIVE, INCIDENTAL, CONSEQUENTIAL OR EXEMPLARY DAMAGES IN CONNECTION WITH OR ARISING OUT OF TI RESOURCES OR USE THEREOF, AND REGARDLESS OF WHETHER TI HAS BEEN ADVISED OF THE POSSIBILITY OF SUCH DAMAGES.

Unless TI has explicitly designated an individual product as meeting the requirements of a particular industry standard (e.g., ISO/TS 16949 and ISO 26262), TI is not responsible for any failure to meet such industry standard requirements.

Where TI specifically promotes products as facilitating functional safety or as compliant with industry functional safety standards, such products are intended to help enable customers to design and create their own applications that meet applicable functional safety standards and requirements. Using products in an application does not by itself establish any safety features in the application. Designers must ensure compliance with safety-related requirements and standards applicable to their applications. Designer may not use any TI products in life-critical medical equipment unless authorized officers of the parties have executed a special contract specifically governing such use. Life-critical medical equipment is medical equipment where failure of such equipment would cause serious bodily injury or death (e.g., life support, pacemakers, defibrillators, heart pumps, neurostimulators, and implantables). Such equipment includes, without limitation, all medical devices identified by the U.S. Food and Drug Administration as Class III devices and equivalent classifications outside the U.S.

TI may expressly designate certain products as completing a particular qualification (e.g., Q100, Military Grade, or Enhanced Product). Designers agree that it has the necessary expertise to select the product with the appropriate qualification designation for their applications and that proper product selection is at Designers' own risk. Designers are solely responsible for compliance with all legal and regulatory requirements in connection with such selection.

Designer will fully indemnify TI and its representatives against any damages, costs, losses, and/or liabilities arising out of Designer's non-compliance with the terms and provisions of this Notice.

## Looking for pricing, stock, or lifecycle information?

Click below to explore more details on WIN SOURCE:

 [View LM4809LDX](#) on WIN SOURCE

 [Texas Instruments](#) Information

## Optimize Your Supply Chain with WIN SOURCE Solutions

-  Global Sourcing Solution
-  Obsolete Management
-  Cost Control Management
-  Shortage Management
-  Alternative Solution
-  Excess Inventory Management