



**THE DATASHEET OF  
LM4755TSX/NOPB**



## LM4755 Stereo 11W Audio Power Amplifier with Mute

Check for Samples: [LM4755](#)

### FEATURES

- Drives 4Ω and 8Ω Loads
- Integrated Mute Function
- Internal Gain Resistors
- Minimal External Components Needed
- Single Supply Operation
- Internal Current Limiting and Thermal Protection
- Compact 9-lead TO-220 Package
- Wide Supply Range 9V - 40V

### APPLICATIONS

- Stereos TVs
- Compact Stereos
- Mini Component Stereos

### KEY SPECIFICATIONS

- Output Power at 10% THD with 1kHz into 4Ω at  $V_{CC} = 24V$  11 W (typ)
- Output Power at 10% THD with 1kHz into 8Ω at  $V_{CC} = 24V$  7 W (typ)
- Closed Loop Gain 34 dB (typ)
- $P_O$  at 10% THD+N @ 1kHz into 4Ω Single-Ended DDPAK Package at  $V_{CC}=12V$  2.5 W (typ)
- $P_O$  at 10% THD+N @ 1kHz into 8Ω Bridged DDPAK Package at  $V_{CC}=12V$  5 W (typ)

### DESCRIPTION

The LM4755 is a stereo audio amplifier capable of delivering 11W per channel of continuous average output power to a 4Ω load or 7W per channel into 8Ω using a single 24V supply at 10% THD+N. The internal mute circuit and pre-set gain resistors provide for a very economical design solution.

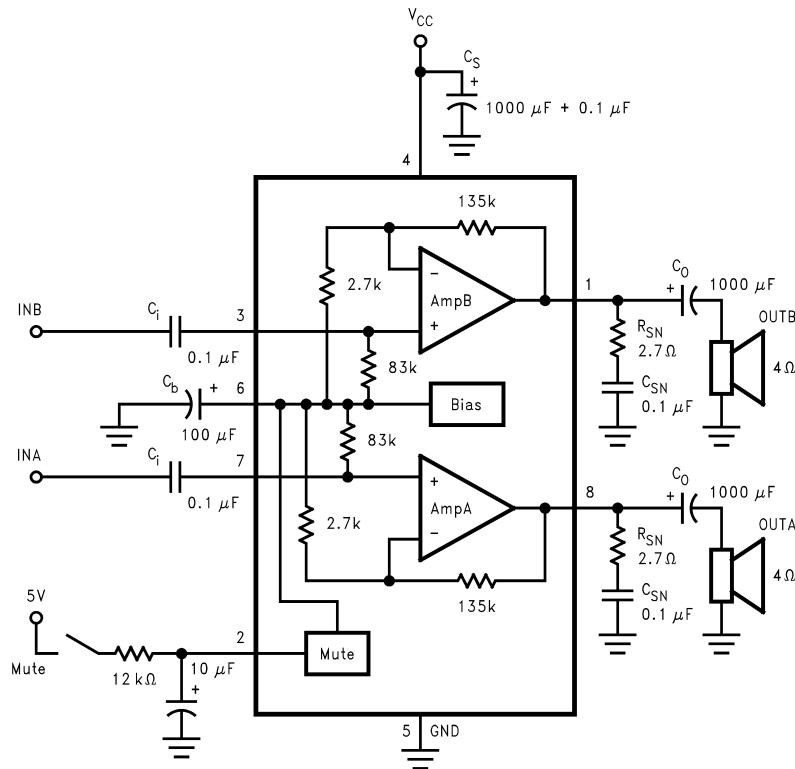
Output power specifications at both 20V and 24V supplies and low external component count offer high value to consumer electronic manufacturers for stereo TV and compact stereo applications. The LM4755 is specifically designed for single supply operation.



Please be aware that an important notice concerning availability, standard warranty, and use in critical applications of Texas Instruments semiconductor products and disclaimers thereto appears at the end of this data sheet.

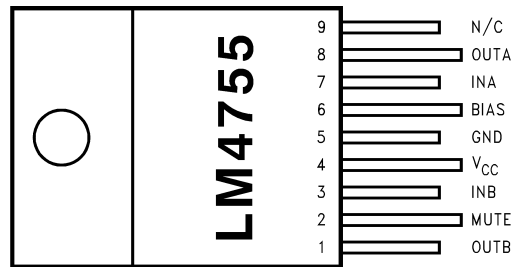
All trademarks are the property of their respective owners.

**TYPICAL APPLICATION**

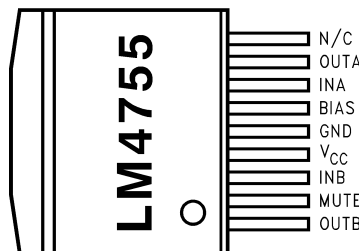


**Figure 1. Typical Audio Amplifier Application Circuit**

**Connection Diagram**



**9 Pin TO-220  
Plastic Package (Top View)  
See Package Number NEC**



**9 Pin DDPACK  
Plastic Package (Top View)  
See Package Number KTW**



These devices have limited built-in ESD protection. The leads should be shorted together or the device placed in conductive foam during storage or handling to prevent electrostatic damage to the MOS gates.

## ABSOLUTE MAXIMUM RATINGS<sup>(1)(2)(3)(4)</sup>

Supply Voltage		40V
Input Voltage		±0.7V
Input Voltage at Output Pins <sup>(5)</sup>		GND -0.4V
Output Current		Internally Limited
Power Dissipation <sup>(6)</sup>		62.5W
ESD Susceptibility <sup>(7)</sup>		2 kV
Junction Temperature		150°C
Soldering Information	NEC Package (10 seconds)	250°C
Storage Temperature		-40°C to 150°C

- (1) Absolute Maximum Ratings indicate limits beyond which damage to the device may occur. Operating Ratings indicate conditions for which the device is functional, but do not ensure specific performance limits. Electrical Characteristics state DC and AC electrical specifications under particular test conditions which ensure specific performance limits. This assumes that the device is within the Operating Ratings. Specifications are not ensured for parameters where no limit is given, however, the typical value is a good indication of device performance.
- (2) If Military/Aerospace specified devices are required, please contact the Texas Instruments Sales Office/Distributors for availability and specifications.
- (3) The TO-263 Package is not recommended for  $V_S > 16V$  due to impractical heatsinking limitations.
- (4) All voltages are measured with respect to the GND pin (5), unless otherwise specified.
- (5) The outputs of the LM4755 cannot be driven externally in any mode with a voltage lower than -0.4V below GND or permanent damage to the LM4755 will result.
- (6) For operating at case temperatures above 25°C, the device must be derated based on a 150°C maximum junction temperature and a thermal resistance of  $\theta_{JC} = 2^\circ\text{C/W}$  (junction to case). Refer to the section [DETERMINING MAXIMUM POWER DISSIPATION](#) in the [APPLICATION INFORMATION](#) section for more information.
- (7) Human body model, 100 pF discharged through a 1.5 kΩ resistor.

## OPERATING RATINGS

Temperature Range $T_{MIN} \leq T_A \leq T_{MAX}$	-40°C ≤ $T_A$ ≤ +85°C
Supply Voltage	9V to 32V
$\theta_{JC}$	2°C/W
$\theta_{JA}$	76°C/W

## ELECTRICAL CHARACTERISTICS

The following specifications apply to each channel with  $V_{CC} = 24V$ ,  $T_A = 25^\circ\text{C}$  unless otherwise specified.

Symbol	Parameter	Conditions	LM4755		Units (Limits)
			Typical <sup>(1)</sup>	Limit	
$I_{TOTAL}$	Total Quiescent Power Supply Current	Mute Off	10	15	mA(max)
		Mute On	7	7	mA(min)
$P_O$	Output Power (Continuous Average per Channel)	$f = 1 \text{ kHz}$ , THD+N = 10%, $R_L = 8\Omega$	7	10	W
		$f = 1 \text{ kHz}$ , THD+N = 10%, $R_L = 4\Omega$	11		W(min)
		$V_S = 20V$ , $R_L = 8\Omega$	4	W	
		$V_S = 20V$ , $R_L = 4\Omega$	7	W	
		$f = 1 \text{ kHz}$ , THD+N = 10%, $R_L = 4\Omega$ $V_S = 12V$ , DDPK Pkg.	2.5	W	
THD	Total Harmonic Distortion	$f = 1 \text{ kHz}$ , $P_O = 1 \text{ W/ch}$ , $R_L = 8\Omega$	0.08		%
$V_{OSW}$	Output Swing	$P_O = 10W$ , $R_L = 8\Omega$	15		V
		$P_O = 10W$ , $R_L = 4\Omega$	14		V
$X_{TALK}$	Channel Separation	See Apps. Circuit ( <a href="#">Figure 1</a> ) $f = 1 \text{ kHz}$ , $V_O = 4 \text{ Vrms}$	55		dB

- (1) Typicals are measured at 25°C and represent the parametric norm.

## ELECTRICAL CHARACTERISTICS (continued)

The following specifications apply to each channel with  $V_{CC} = 24V$ ,  $T_A = 25^\circ C$  unless otherwise specified.

Symbol	Parameter	Conditions	LM4755		Units (Limits)
			Typical <sup>(1)</sup>	Limit	
PSRR	Power Supply Rejection Ratio	See Apps. Circuit (Figure 1) $f = 120 \text{ Hz}$ , $V_O = 1 \text{ mVrms}$	50		dB
$V_{ODV}$	Differential DC Output Offset Voltage	$V_{IN} = 0V$	0.09	0.4	V(max)
SR	Slew Rate		2		V/ $\mu s$
$R_{IN}$	Input Impedance		83		k $\Omega$
PBW	Power Bandwidth	3 dB BW at $P_O = 2.5W$ , $R_L = 8\Omega$	65		kHz
$A_{VCL}$	Closed Loop Gain (Internally Set)	$R_L = 8\Omega$	34	33 35	dB(min) dB(max)
$\epsilon_{IN}$	Noise	IHF-A Weighting Filter, $R_L = 8\Omega$ Output Referred	0.2		mVrms
$I_O$	Output Short Circuit Limit	$V_{IN} = 0.5V$ , $R_L = 2\Omega$		2	A(min)
Mute Pin $V_{IL}$	Mute Low Input Voltage	Not in Mute Mode		0.8	V(max)
$V_{IH}$	Mute High Input Voltage	In Mute Mode	2.0	2.5	V(min)
$A_M$	Mute Attenuation	$V_{MUTE} = 5.0V$	80		dB

## EQUIVALENT SCHEMATIC

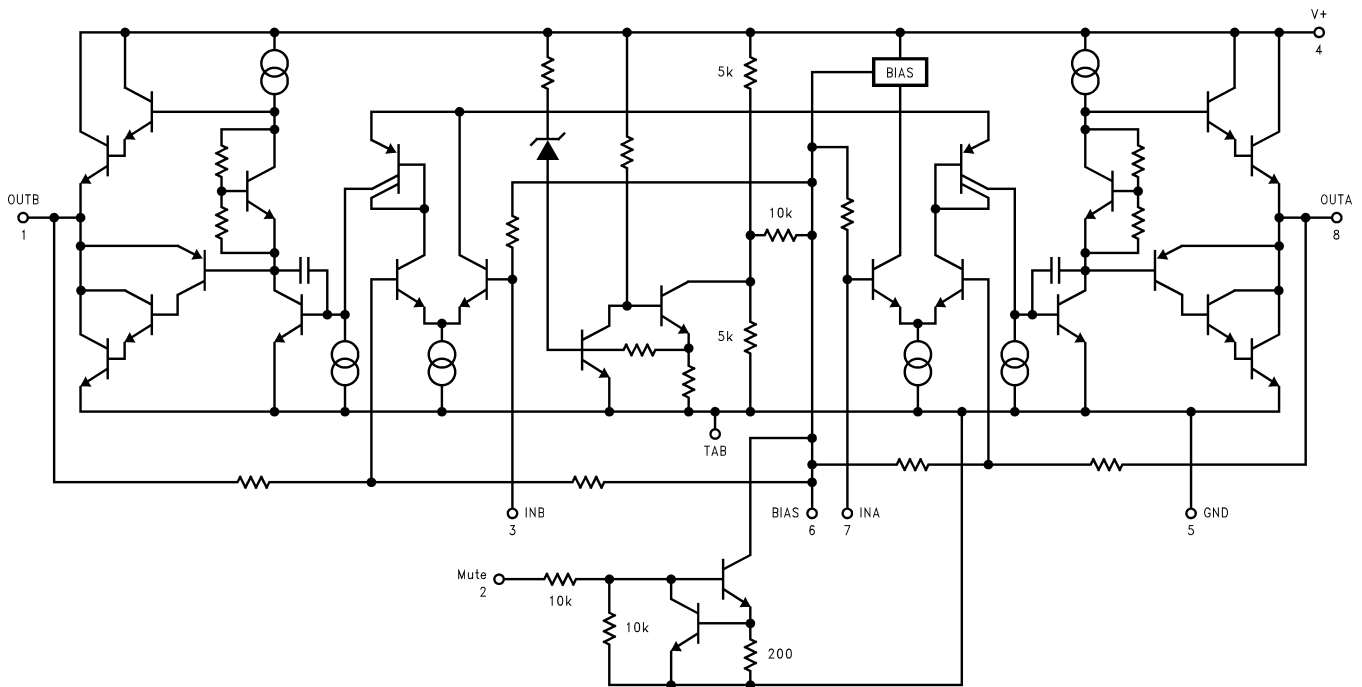


Figure 2.

TEST CIRCUIT

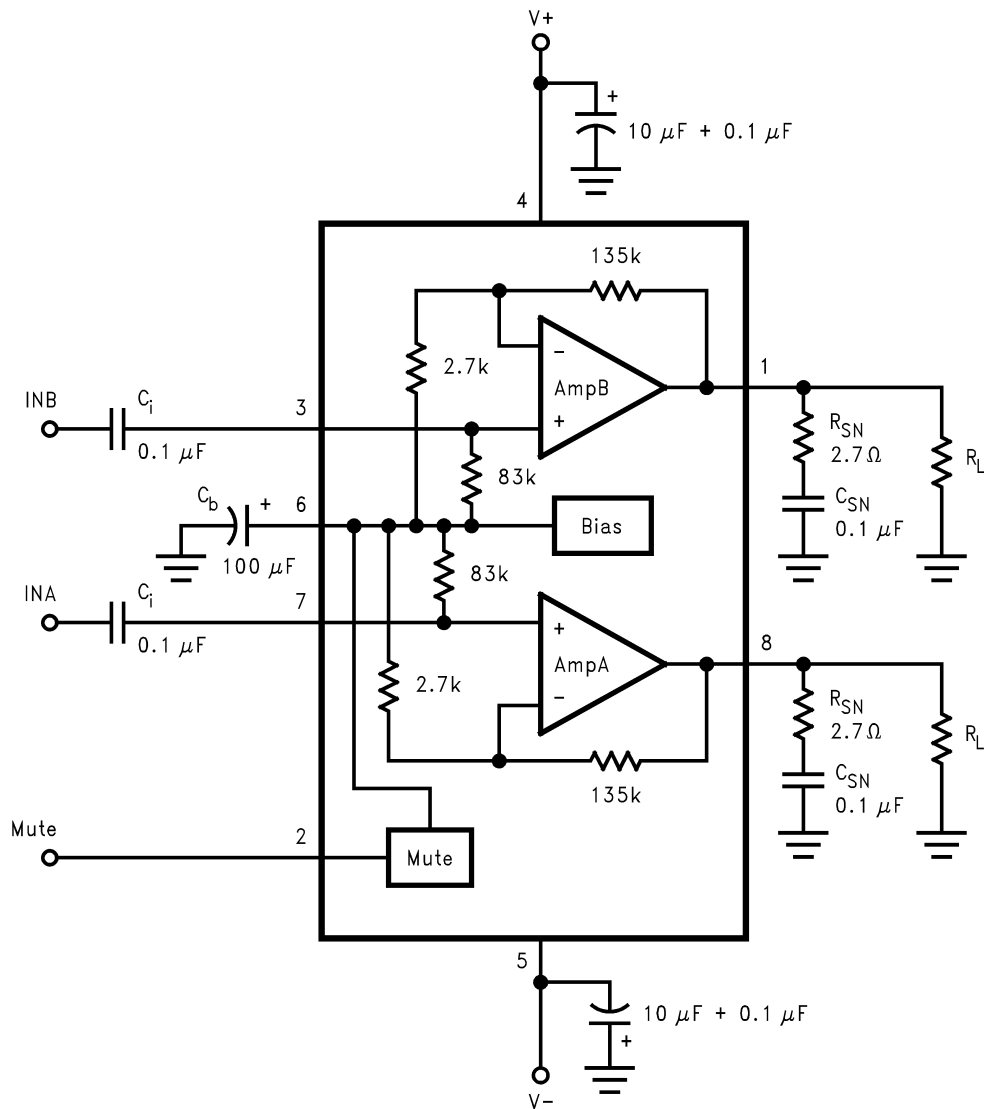


Figure 3. Test Circuit

## SYSTEM APPLICATION CIRCUIT

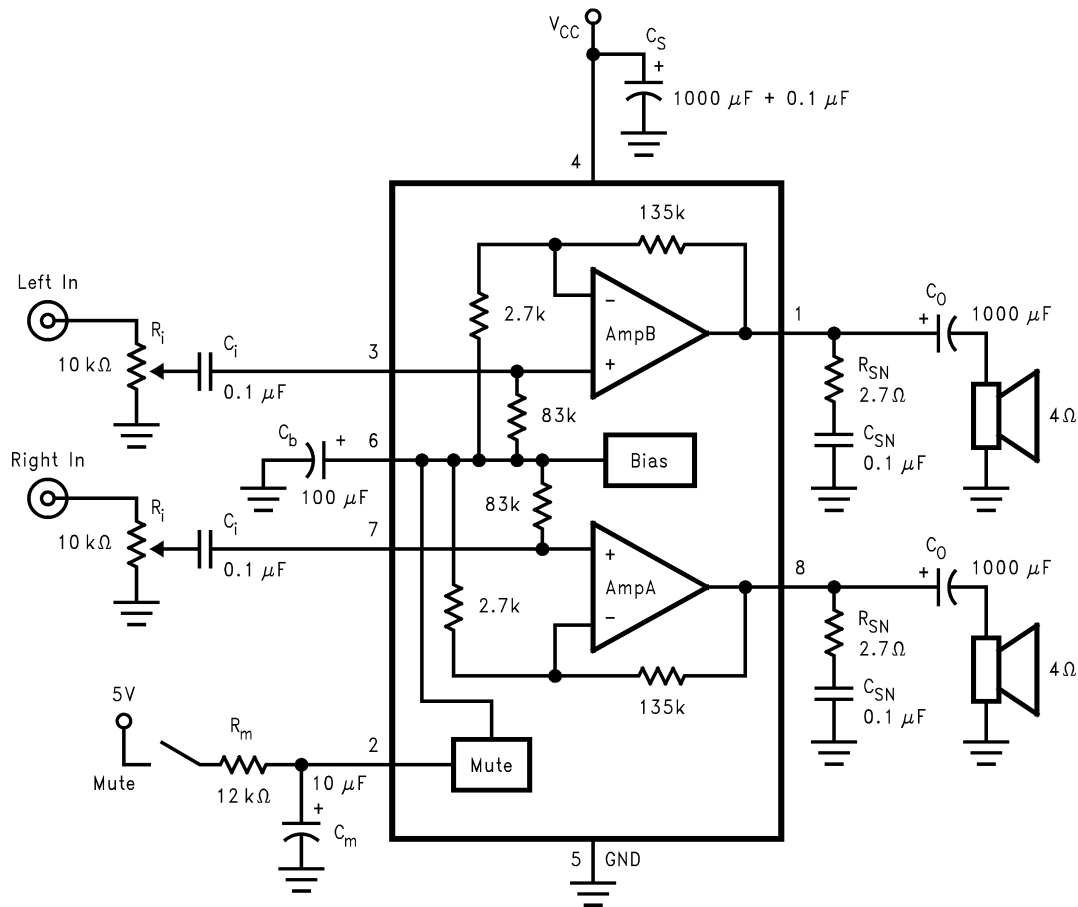


Figure 4. Circuit for External Components Description

## EXTERNAL COMPONENTS DESCRIPTION

Components	Function Description	
1, 2	$C_S$	Provides power supply filtering and bypassing.
3, 4	$R_{SN}$	Works with $C_{SN}$ to stabilize the output stage from high frequency oscillations.
5, 6	$C_{SN}$	Works with $R_{SN}$ to stabilize the output stage from high frequency oscillations.
7	$C_b$	Provides filtering for the internally generated half-supply bias generator.
8, 9	$C_i$	Input AC coupling capacitor which blocks DC voltage at the amplifier's input terminals. Also creates a high pass filter with $f_c=1/(2 \cdot \pi \cdot R_{in} \cdot C_{in})$ .
10, 11	$C_o$	Output AC coupling capacitor which blocks DC voltage at the amplifier's output terminal. Creates a high pass filter with $f_c=1/(2 \cdot \pi \cdot R_{out} \cdot C_{out})$ .
12, 13	$R_i$	Voltage control - limits the voltage level allowed to the amplifier's input terminals.
14	$R_m$	Works with $C_m$ to provide mute function timing.
15	$C_m$	Works with $R_m$ to provide mute function timing.

### TYPICAL PERFORMANCE CHARACTERISTICS

Typicals are measured at 25°C and represent the parametric norm.

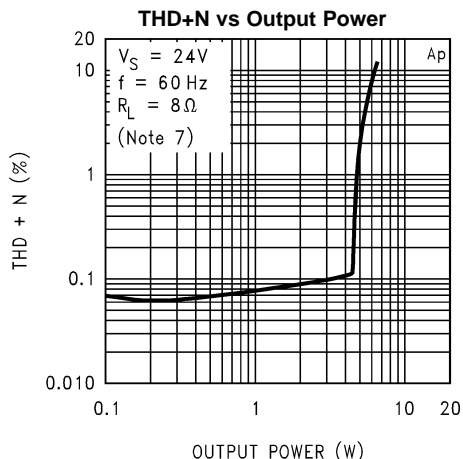


Figure 5.

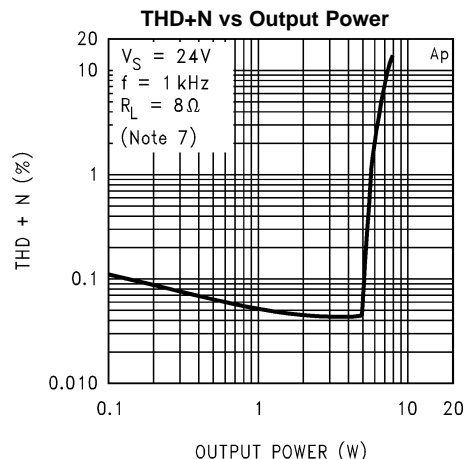


Figure 6.

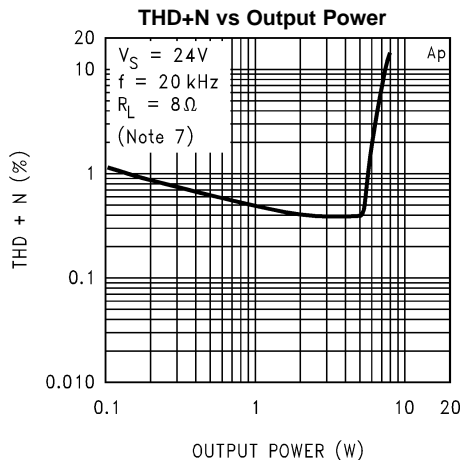


Figure 7.

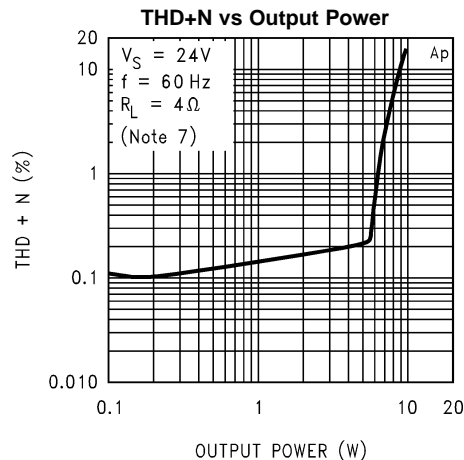


Figure 8.

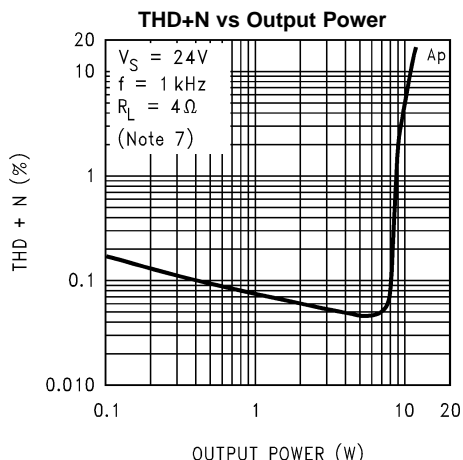


Figure 9.

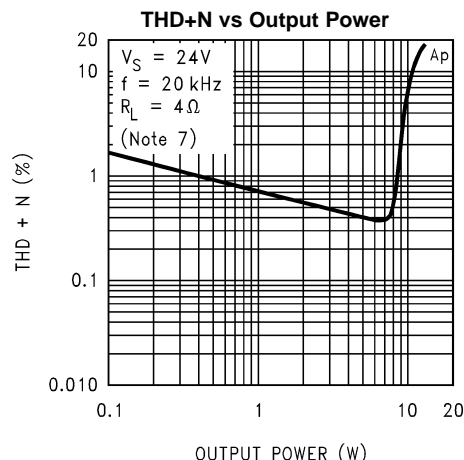


Figure 10.

**TYPICAL PERFORMANCE CHARACTERISTICS (continued)**

Typicals are measured at 25°C and represent the parametric norm.

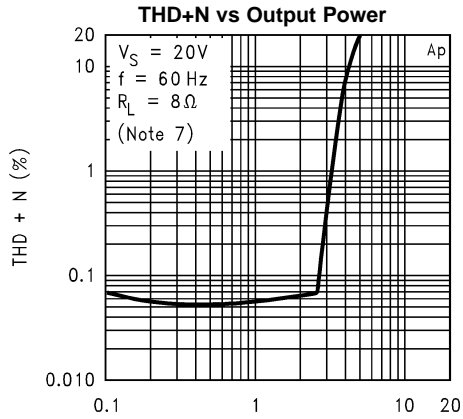


Figure 11.

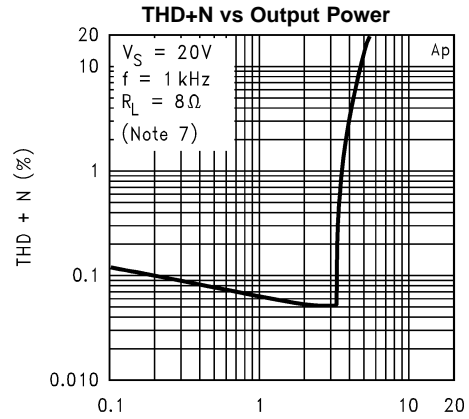


Figure 12.

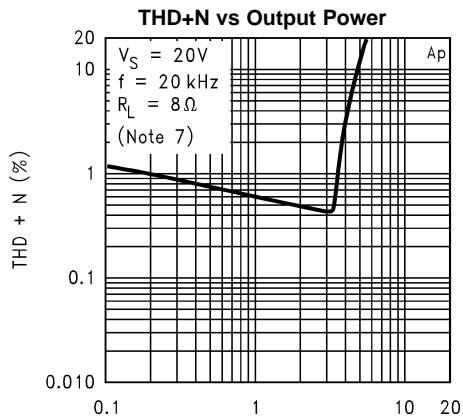


Figure 13.

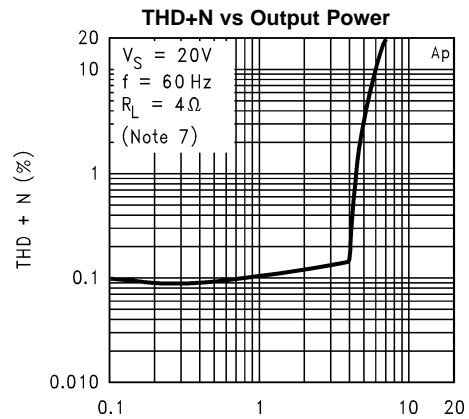


Figure 14.

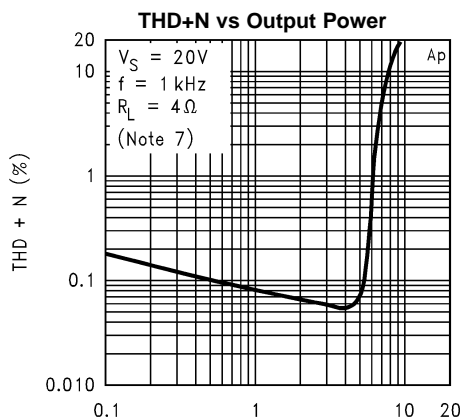


Figure 15.

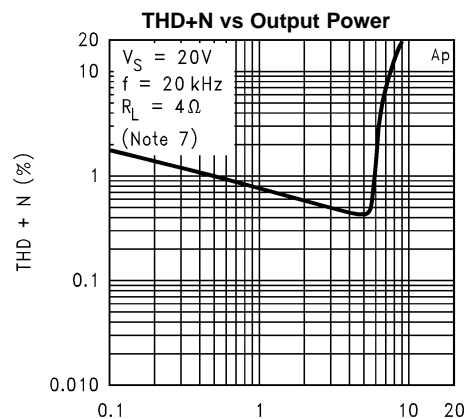


Figure 16.

**TYPICAL PERFORMANCE CHARACTERISTICS (continued)**

Typicals are measured at 25°C and represent the parametric norm.

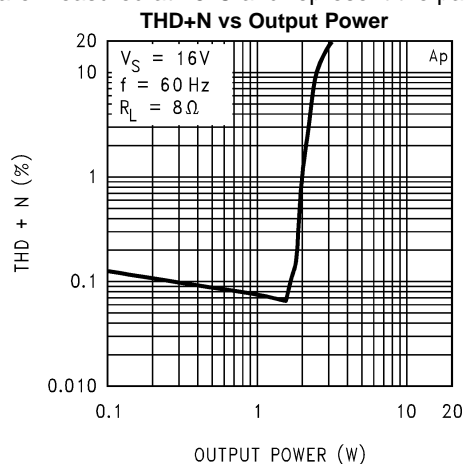


Figure 17.

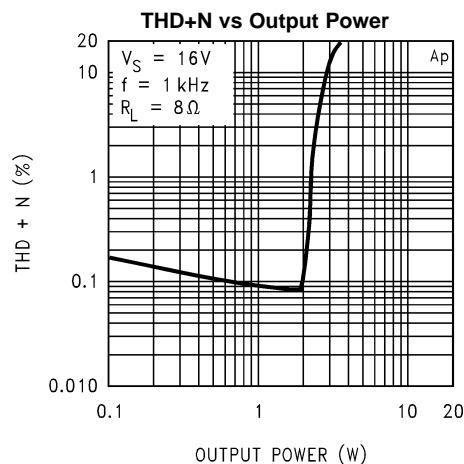


Figure 18.

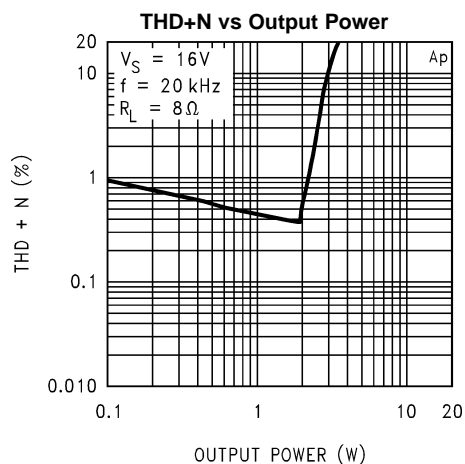


Figure 19.

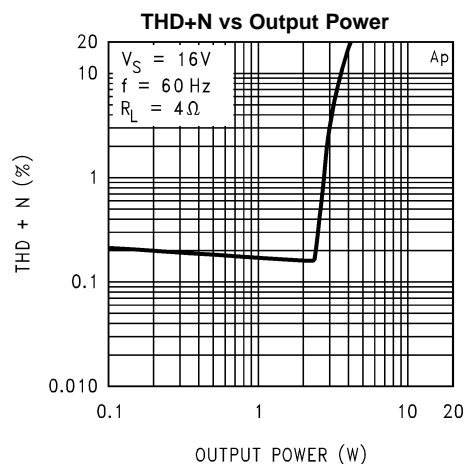


Figure 20.

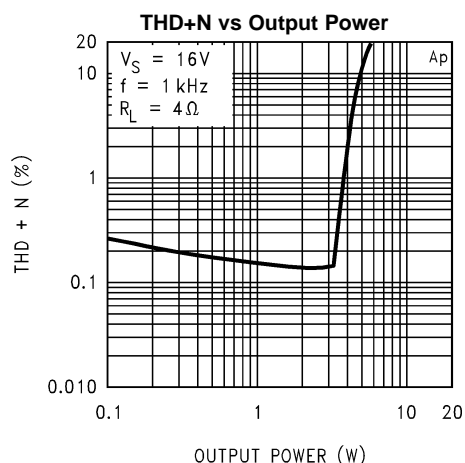


Figure 21.

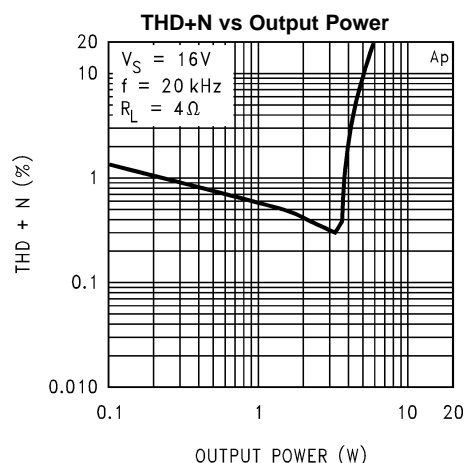


Figure 22.

**TYPICAL PERFORMANCE CHARACTERISTICS (continued)**

Typicals are measured at 25°C and represent the parametric norm.

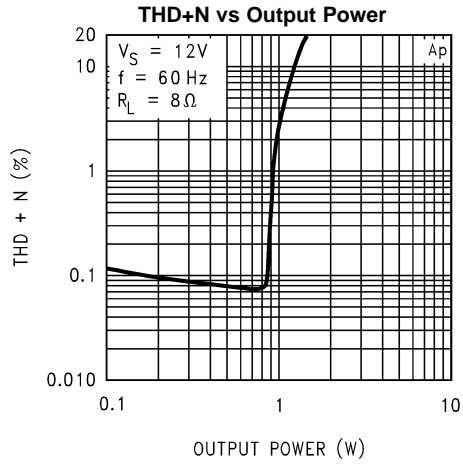


Figure 23.

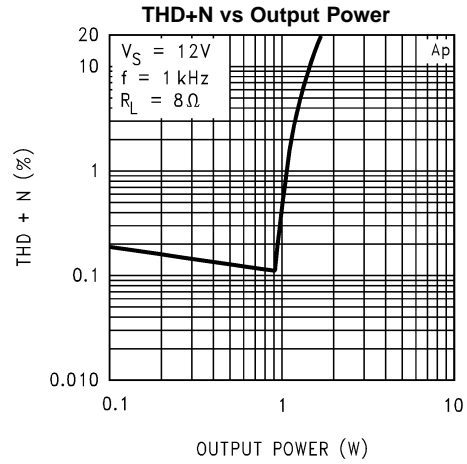


Figure 24.

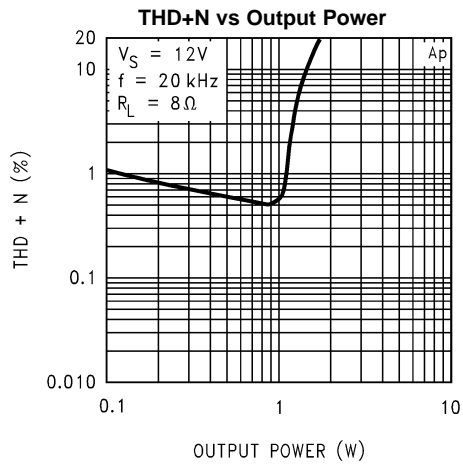


Figure 25.

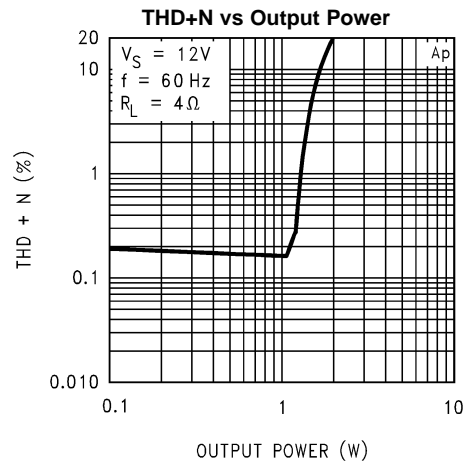


Figure 26.

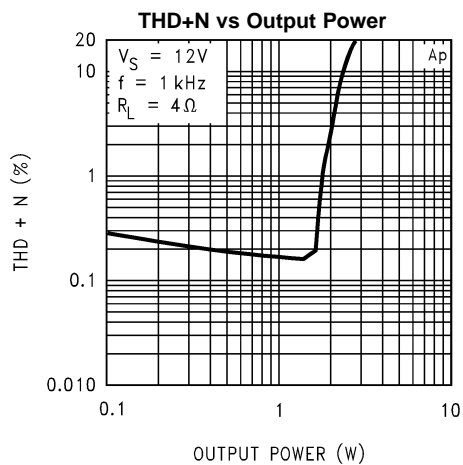


Figure 27.

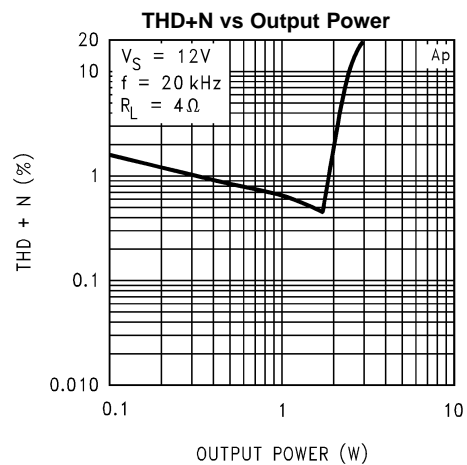


Figure 28.

**TYPICAL PERFORMANCE CHARACTERISTICS (continued)**

Typicals are measured at 25°C and represent the parametric norm.

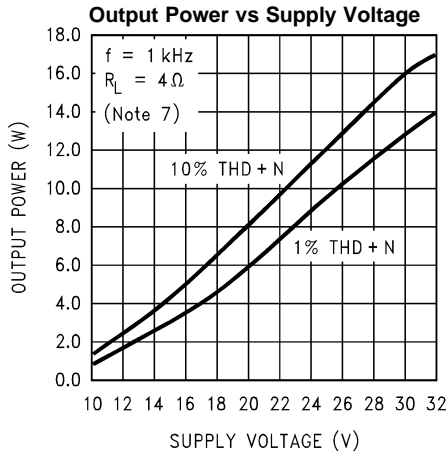


Figure 29.

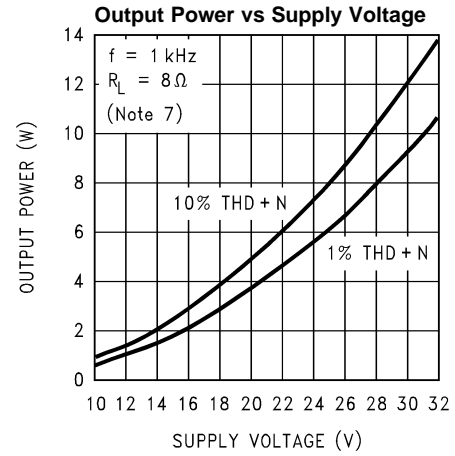


Figure 30.

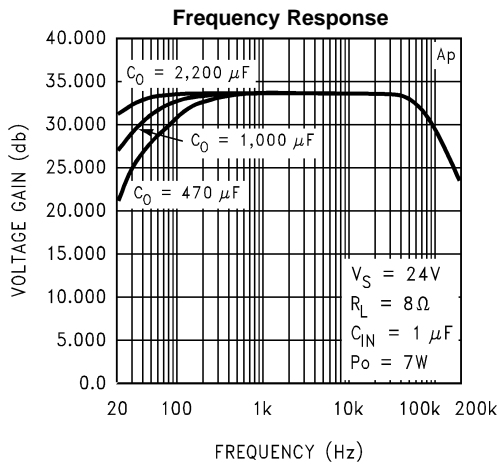


Figure 31.

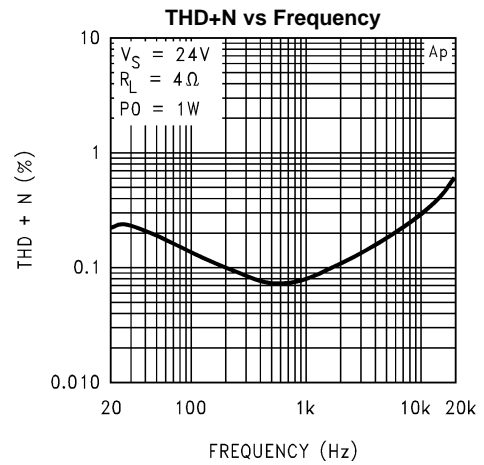


Figure 32.

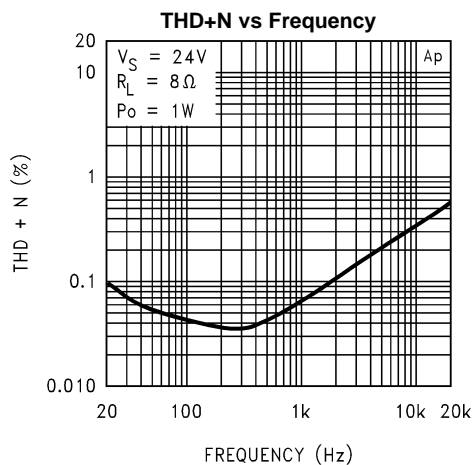


Figure 33.

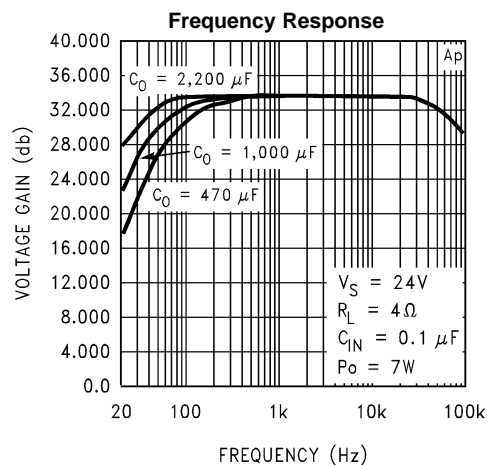


Figure 34.

**TYPICAL PERFORMANCE CHARACTERISTICS (continued)**

Typicals are measured at 25°C and represent the parametric norm.

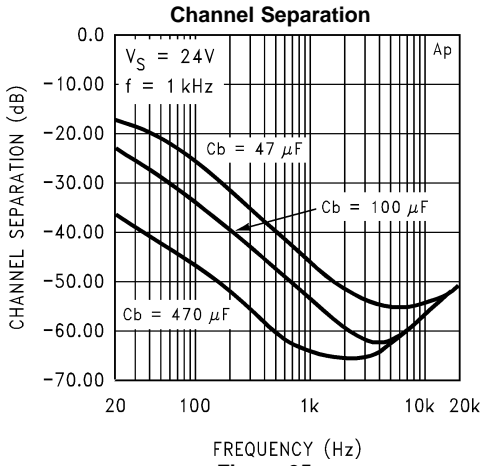


Figure 35.

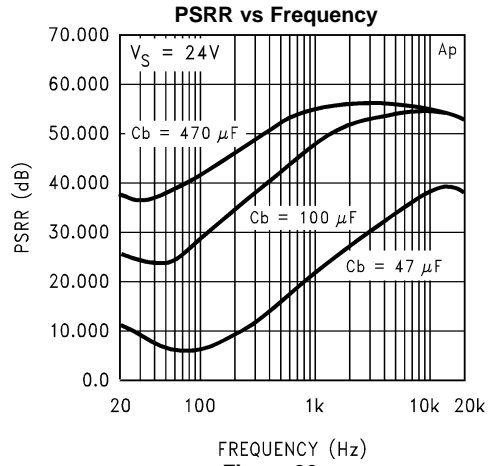


Figure 36.

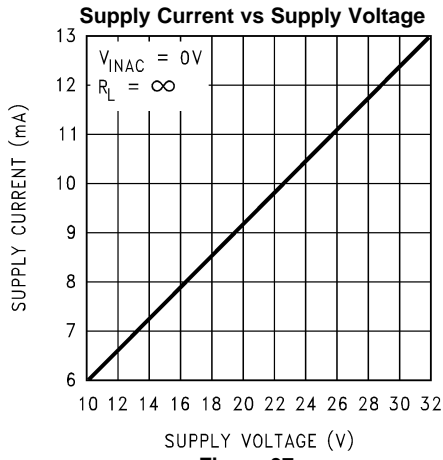


Figure 37.

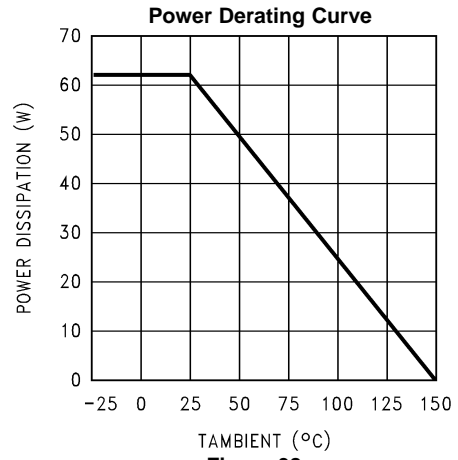


Figure 38.

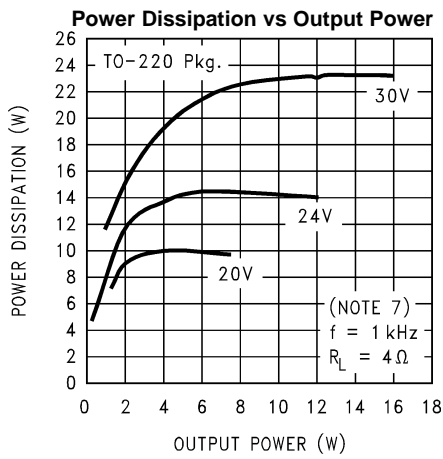


Figure 39.

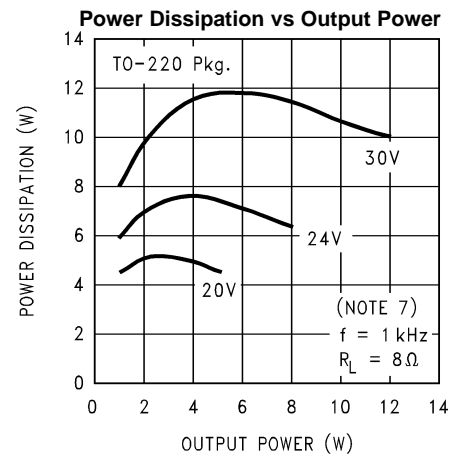
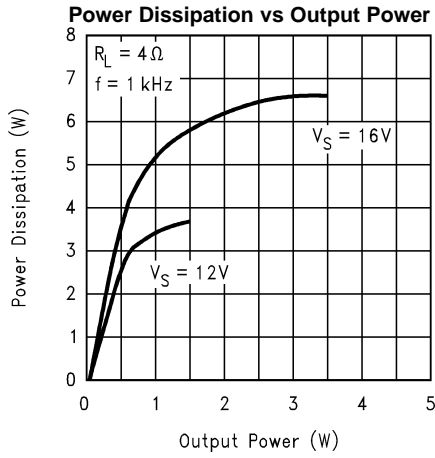


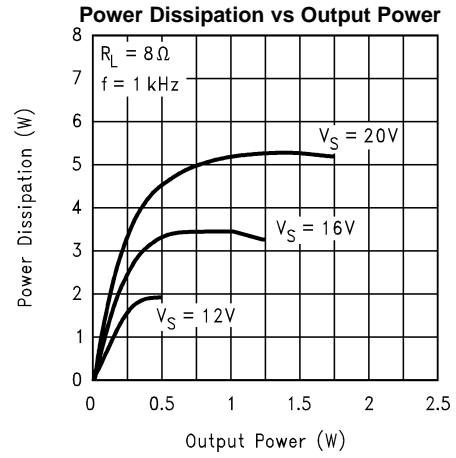
Figure 40.

**TYPICAL PERFORMANCE CHARACTERISTICS (continued)**

Typicals are measured at 25°C and represent the parametric norm.



**Figure 41.**



**Figure 42.**

## APPLICATION INFORMATION

The LM4755 contains circuitry to pull down the bias line internally, effectively shutting down the input stage. An external R-C should be used to adjust the timing of the pull-down. If the bias line is pulled down too quickly, currents induced in the internal bias resistors will cause a momentary DC voltage to appear across the inputs of each amplifier's internal differential pair, resulting in an output DC shift towards  $V_{supply}$ . An R-C timing circuit should be used to limit the pull-down time such that output "pops" and signal feedthroughs will be minimized. The pull-down timing is a function of a number of factors, including the internal mute circuitry, the voltage used to activate the mute, the bias capacitor, the half-supply voltage, and internal resistances used in the half-supply generator. [Table 1](#) shows a list of recommended values for the external R-C.

**Table 1. RECOMMENDED VALUES FOR MUTE CIRCUIT**

$V_{MUTE}$	$V_{CC}$	$R_m$	$C_m$
5V	12V	18 k $\Omega$	10 $\mu$ F
5V	15V	18 k $\Omega$	10 $\mu$ F
5V	20V	12 k $\Omega$	10 $\mu$ F
5V	24V	12 k $\Omega$	10 $\mu$ F
5V	28V	8.2 k $\Omega$	10 $\mu$ F
5V	30V	8.2 k $\Omega$	10 $\mu$ F

### CAPACITOR SELECTION AND FREQUENCY RESPONSE

With the LM4755, as in all single supply amplifiers, AC coupling capacitors are used to isolate the DC voltage present at the inputs (pins 3, 7) and outputs (pins 1, 8). As mentioned earlier in the [EXTERNAL COMPONENTS DESCRIPTION](#) section these capacitors create high-pass filters with their corresponding input/output impedances. The Typical Application Circuit shown in [Figure 1](#) shows input and output capacitors of 0.1  $\mu$ F and 1,000  $\mu$ F respectively. At the input, with an 83 k $\Omega$  typical input resistance, the result is a high pass 3 dB point occurring at 19 Hz. There is another high pass filter at 39.8 Hz created with the output load resistance of 4 $\Omega$ . Careful selection of these components is necessary to ensure that the desired frequency response is obtained. The Frequency Response curves in the [TYPICAL PERFORMANCE CHARACTERISTICS](#) section show how different output coupling capacitors affect the low frequency roll-off.

### OPERATING IN BRIDGE-MODE

Though designed for use as a single-ended amplifier, the LM4755 can be used to drive a load differentially (bridge-mode). Due to the low pin count of the package, only the non-inverting inputs are available. An inverted signal must be provided to one of the inputs. This can easily be done with the use of an inexpensive op-amp configured as a standard inverting amplifier. An LF353 is a good low-cost choice. Care must be taken, however, for a bridge-mode amplifier must theoretically dissipate four times the power of a single-ended type. The load seen by each amplifier is effectively half that of the actual load being used, thus an amplifier designed to drive a 4 $\Omega$  load in single-ended mode should drive an 8 $\Omega$  load when operating in bridge-mode.

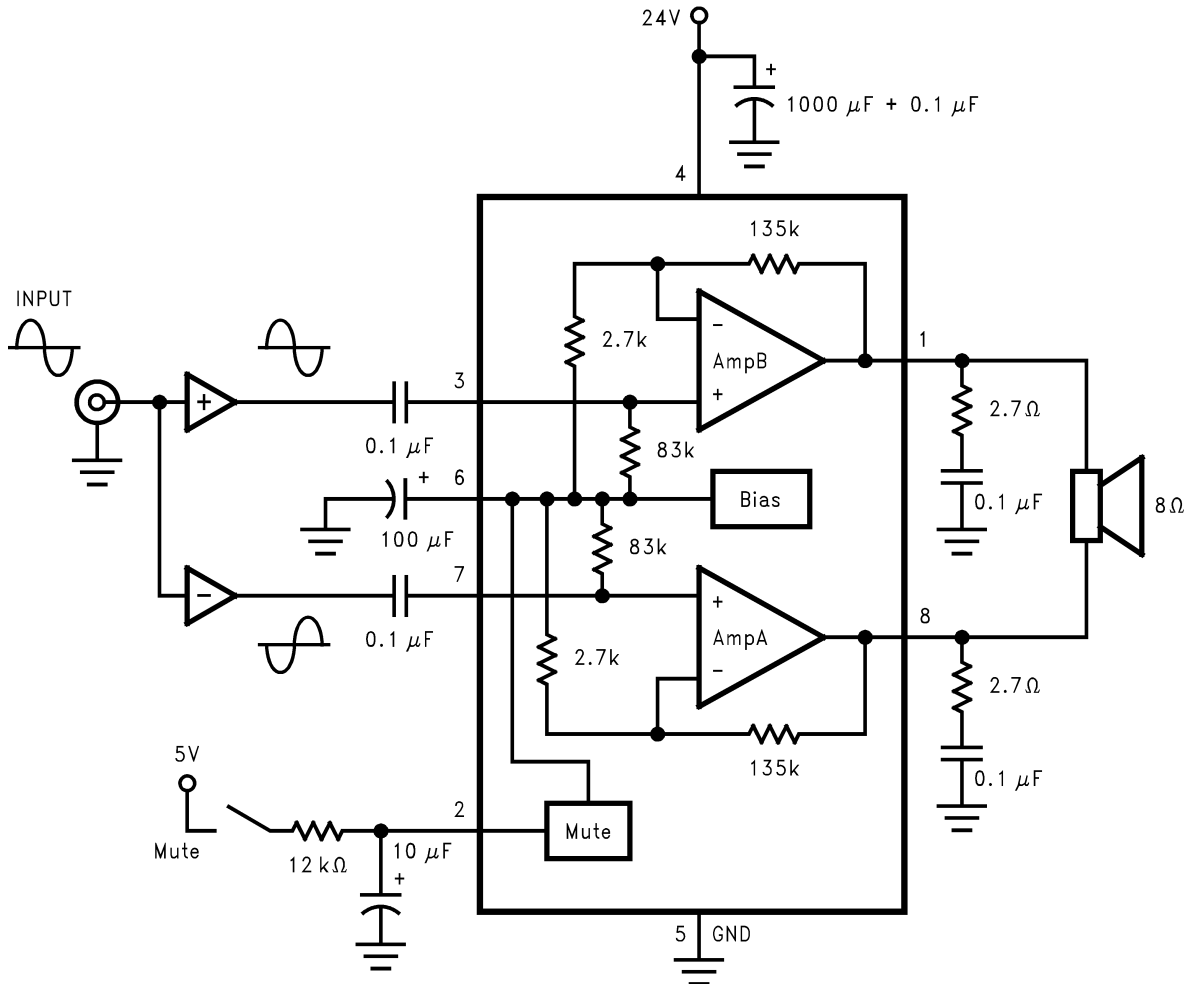


Figure 43. Bridge-Mode Application

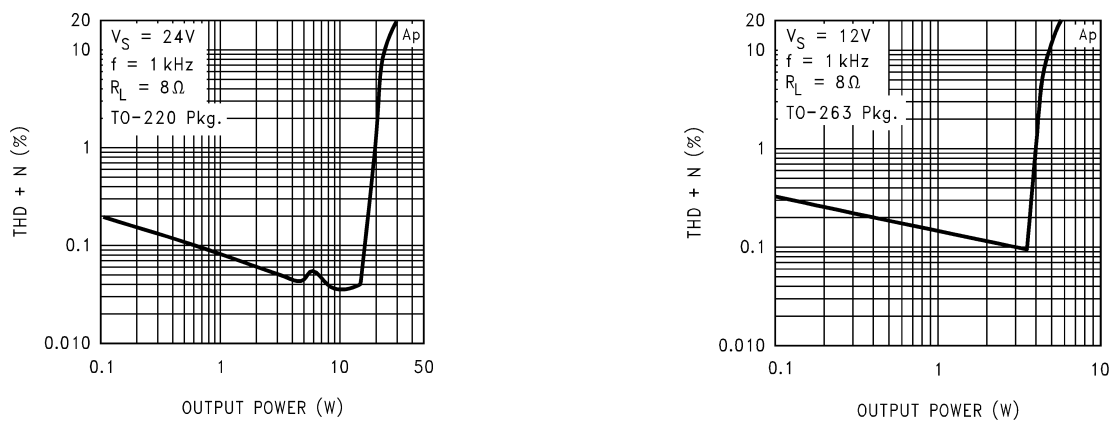


Figure 44. THD+N vs P<sub>OUT</sub> for Bridge-Mode Application

## PREVENTING OSCILLATIONS

With the integration of the feedback and bias resistors on-chip, the LM4755 fits into a very compact package. However, due to the close proximity of the non-inverting input pins to the corresponding output pins, the inputs should be AC terminated at all times. If the inputs are left floating, the amplifier will have a positive feedback path through high impedance coupling, resulting in a high frequency oscillation. In most applications, this termination is typically provided by the previous stage's source impedance. If the application will require an external signal, the inputs should be terminated to ground with a resistance of 50 kΩ or less on the AC side of the input coupling capacitors.

## UNDERVOLTAGE SHUTDOWN

If the power supply voltage drops below the minimum operating supply voltage, the internal under-voltage detection circuitry pulls down the half-supply bias line, shutting down the preamp section of the LM4755. Due to the wide operating supply range of the LM4755, the threshold is set to just under 9V. There may be certain applications where a higher threshold voltage is desired. One example is a design requiring a high operating supply voltage, with large supply and bias capacitors, and there is little or no other circuitry connected to the main power supply rail. In this circuit, when the power is disconnected, the supply and bias capacitors will discharge at a slower rate, possibly resulting in audible output distortion as the decaying voltage begins to clip the output signal. An external circuit may be used to sense for the desired threshold, and pull the bias line (pin 6) to ground to disable the input preamp. Figure 45 shows an example of such a circuit. When the voltage across the zener diode drops below its threshold, current flow into the base of Q1 is interrupted. Q2 then turns on, discharging the bias capacitor. This discharge rate is governed by several factors, including the bias capacitor value, the bias voltage, and the resistor at the emitter of Q2. An equation for approximating the value of the emitter discharge resistor, R, is given below:

$$R = (0.7V) / (Cb \cdot (V_{CC}/2) / 0.1s) \quad (1)$$

Note that this is only a linearized approximation based on a discharge time of 0.1s. The circuit should be evaluated and adjusted for each application.

As mentioned earlier in the [Built-in Mute Circuit](#) section, when using an external circuit to pull down the bias line, the rate of discharge will have an effect on the turn-off induced distortions. Please refer to the [Table 1](#) section for more information.

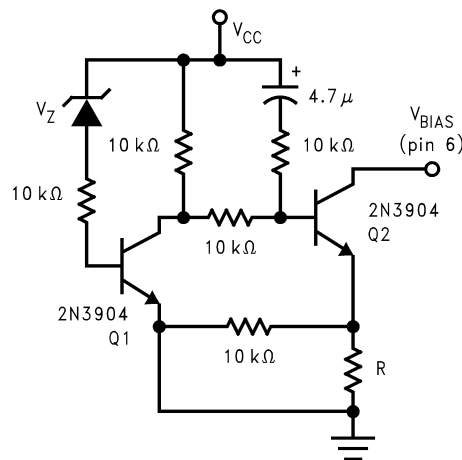


Figure 45. External Undervoltage Pull-Down

## THERMAL CONSIDERATIONS

### Heat Sinking

Proper heatsinking is necessary to ensure that the amplifier will function correctly under all operating conditions. A heatsink that is too small will cause the die to heat excessively and will result in a degraded output signal as the thermal protection circuitry begins to operate.

The choice of a heatsink for a given application is dictated by several factors: the maximum power the IC needs to dissipate, the worst-case ambient temperature of the circuit, the junction-to-case thermal resistance, and the maximum junction temperature of the IC. The heat flow approximation equation used in determining the correct heatsink maximum thermal resistance is given below:

$$T_J - T_A = P_{DMAX} \cdot (\theta_{JC} + \theta_{CS} + \theta_{SA})$$

where

- $P_{DMAX}$  = maximum power dissipation of the IC
- $T_J(^{\circ}\text{C})$  = junction temperature of the IC
- $T_A(^{\circ}\text{C})$  = ambient temperature
- $\theta_{JC}(^{\circ}\text{C}/\text{W})$  = junction-to-case thermal resistance of the IC
- $\theta_{CS}(^{\circ}\text{C}/\text{W})$  = case-to-heatsink thermal resistance (typically 0.2 to 0.5  $^{\circ}\text{C}/\text{W}$ )
- $\theta_{SA}(^{\circ}\text{C}/\text{W})$  = thermal resistance of heatsink (2)

When determining the proper heatsink, the above equation should be re-written as:

$$\theta_{SA} \leq [(T_J - T_A) / P_{DMAX}] - \theta_{JC} - \theta_{CS} \quad (3)$$

### DDPAK HEATSINKING

Surface mount applications will be limited by the thermal dissipation properties of printed circuit board area. The DDPACK package is not recommended for surface mount applications with  $V_S > 16\text{V}$  due to limited printed circuit board area. There are DDPACK package enhancements, such as clip-on heatsinks and heatsinks with adhesives, that can be used to improve performance.

Standard FR-4 single-sided copper clad will have an approximate Thermal resistance ( $\theta_{SA}$ ) ranging from:

1.5 × 1.5 in. sq.	20–27 $^{\circ}\text{C}/\text{W}$	( $T_A=28^{\circ}\text{C}$ , Sine wave testing, 1 oz. Copper)
2 × 2 in. sq.	16–23 $^{\circ}\text{C}/\text{W}$	

The above values for  $\theta_{SA}$  vary widely due to dimensional proportions (i.e. variations in width and length will vary  $\theta_{SA}$ ).

For audio applications, where peak power levels are short in duration, this part will perform satisfactory with less heatsinking/copper clad area. As with any high power design proper bench testing should be undertaken to assure the design can dissipate the required power. Proper bench testing requires attention to worst case ambient temperature and air flow. At high power dissipation levels the part will show a tendency to increase saturation voltages, thus limiting the undistorted power levels.

### DETERMINING MAXIMUM POWER DISSIPATION

For a single-ended class AB power amplifier, the theoretical maximum power dissipation point is a function of the supply voltage,  $V_S$ , and the load resistance,  $R_L$  and is given by the following equation:

(single channel)

$$P_{DMAX} (W) = [V_S^2 / (2 \cdot \pi^2 \cdot R_L)]$$

The above equation is for a single channel class-AB power amplifier. For dual amplifiers such as the LM4755, the equation for calculating the total maximum power dissipated is:

(dual channel)

$$P_{DMAX} (W) = 2 \cdot [V_S^2 / (2 \cdot \pi^2 \cdot R_L)]$$

or

$$V_S^2 / (\pi^2 \cdot R_L)$$

(Bridged Outputs)

$$P_{DMAX} (W) = 4[V_S^2 / (2\pi^2 \cdot R_L)]$$

## HEATSINK DESIGN EXAMPLE

Determine the system parameters:

$V_S = 24V$	Operating Supply Voltage
$R_L = 4\Omega$	Minimum Load Impedance
$T_A = 55^\circ C$	Worst Case Ambient Temperature

Device parameters from the datasheet:

$T_J = 150^\circ C$	Maximum Junction Temperature
$\theta_{JC} = 2^\circ C/W$	Junction-to-Case Thermal Resistance

Calculations:

$$2 \cdot P_{D_{MAX}} = 2 \cdot [V_S^2 / 2 \cdot \pi^2 \cdot R_L] = (24V)^2 / (2 \cdot \pi^2 \cdot 4\Omega) = 14.6W$$

$$\theta_{SA} \leq [(T_J - T_A) / P_{D_{MAX}}] - \theta_{JC} - \theta_{CS} = [(150^\circ C - 55^\circ C) / 14.6W] - 2^\circ C/W - 0.2^\circ C/W = 4.3^\circ C/W$$

Conclusion: Choose a heatsink with  $\theta_{SA} \leq 4.3^\circ C/W$ .

## DDPAK HEATSINK DESIGN EXAMPLES

### Example 1: (Stereo Single-Ended Output)

**Given:**  $T_A = 30^\circ C$

$$T_J = 150^\circ C$$

$$R_L = 4\Omega$$

$$V_S = 12V$$

$$\theta_{JC} = 2^\circ C/W$$

$P_{D_{MAX}}$  from  $P_D$  vs  $P_O$  Graph:

$$P_{D_{MAX}} \approx 3.7W \quad (4)$$

Calculating  $P_{D_{MAX}}$ :

$$P_{D_{MAX}} = V_{CC}^2 / (\pi^2 R_L) = (12V)^2 / \pi^2 (4\Omega) = 3.65W \quad (5)$$

Calculating Heatsink Thermal Resistance:

$$\theta_{SA} < T_J - T_A / P_{D_{MAX}} - \theta_{JC} - \theta_{CS} \quad (6)$$

$$\theta_{SA} < 120^\circ C / 3.7W - 2.0^\circ C/W - 0.2^\circ C/W = 30.2^\circ C/W \quad (7)$$

Therefore the recommendation is to use 1.5 × 1.5 square inch of single-sided copper clad.

### Example 2: (Stereo Single-Ended Output)

**Given:**  $T_A = 50^\circ C$

$$T_J = 150^\circ C$$

$$R_L = 4\Omega$$

$$V_S = 12V$$

$$\theta_{JC} = 2^\circ C/W$$

$P_{D_{MAX}}$  from  $P_D$  vs  $P_O$  Graph:

$$P_{D_{MAX}} \approx 3.7W \quad (8)$$

Calculating  $P_{D_{MAX}}$ :

$$P_{D_{MAX}} = V_{CC}^2 / (\pi^2 R_L) = (12V)^2 / \pi^2 (4\Omega) = 3.65W \quad (9)$$

Calculating Heatsink Thermal Resistance:

$$\theta_{SA} < [(T_J - T_A) / P_{D_{MAX}}] - \theta_{JC} - \theta_{CS} \quad (10)$$

$$\theta_{SA} < 100^{\circ}\text{C}/3.7\text{W} - 2.0^{\circ}\text{C}/\text{W} - 0.2^{\circ}\text{C}/\text{W} = 24.8^{\circ}\text{C}/\text{W} \quad (11)$$

Therefore the recommendation is to use 2.0 × 2.0 square inch of single-sided copper clad.

**Example 3:** (Bridged Output)

**Given:**  $T_A=50^{\circ}\text{C}$

$$T_J=150^{\circ}\text{C}$$

$$R_L=8\Omega$$

$$V_S=12\text{V}$$

$$\theta_{JC}=2^{\circ}\text{C}/\text{W}$$

Calculating  $P_{D\text{MAX}}$ :

$$P_{D\text{MAX}} = 4[V_{CC}^2/(2\pi^2R_L)] = 4(12\text{V})^2/(2\pi^2(8\Omega)) = 3.65\text{W} \quad (12)$$

Calculating Heatsink Thermal Resistance:

$$\theta_{SA} < [(T_J - T_A) / P_{D\text{MAX}}] - \theta_{JC} - \theta_{CS} \quad (13)$$

$$\theta_{SA} < 100^{\circ}\text{C} / 3.7\text{W} - 2.0^{\circ}\text{C}/\text{W} - 0.2^{\circ}\text{C}/\text{W} = 24.8^{\circ}\text{C}/\text{W} \quad (14)$$

Therefore the recommendation is to use 2.0 × 2.0 square inch of single-sided copper clad.

**LAYOUT AND GROUND RETURNS**

Proper PC board layout is essential for good circuit performance. When laying out a PC board for an audio power amplifier, particular attention must be paid to the routing of the output signal ground returns relative to the input signal and bias capacitor grounds. To prevent any ground loops, the ground returns for the output signals should be routed separately and brought together at the supply ground. The input signal grounds and the bias capacitor ground line should also be routed separately. The 0.1 μF high frequency supply bypass capacitor should be placed as close as possible to the IC.

PC BOARD LAYOUT-COMPOSITE

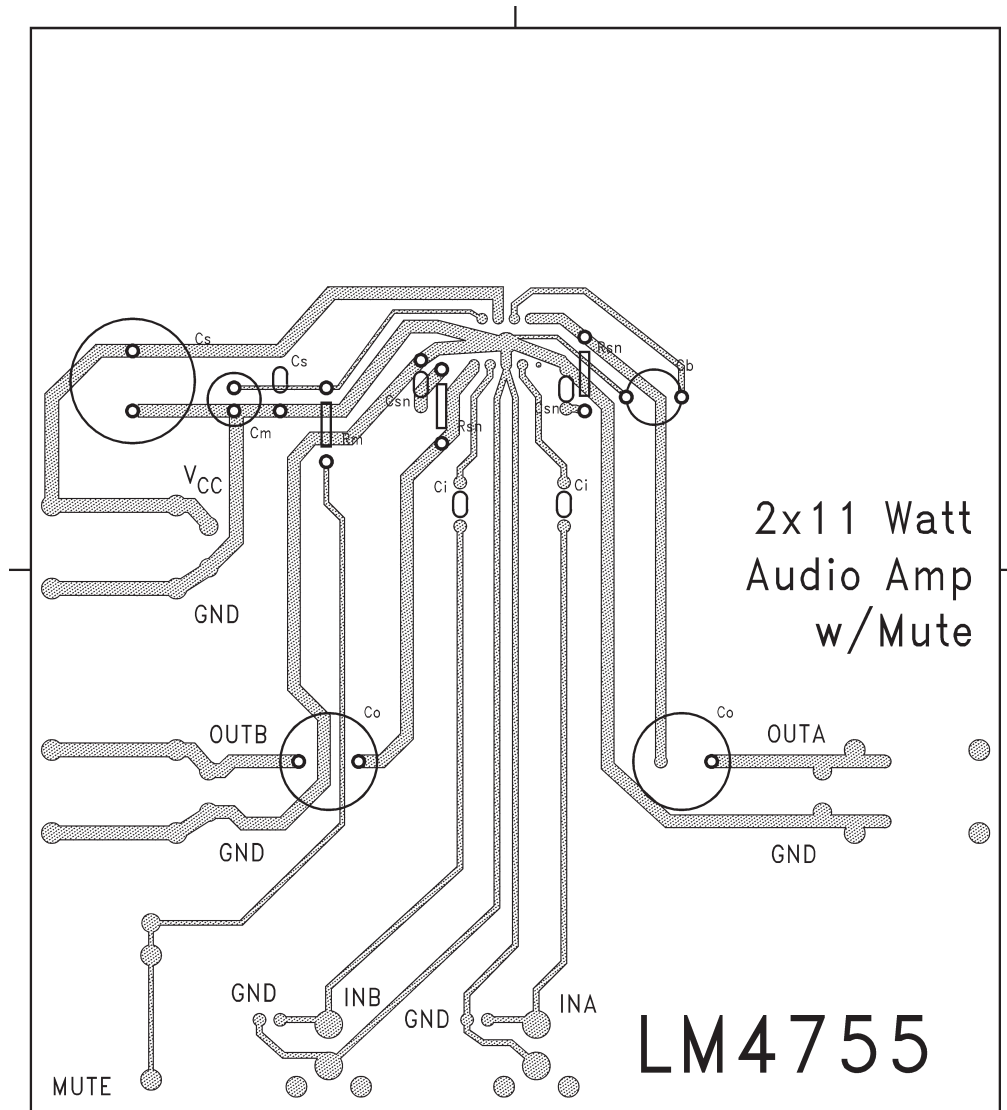


Figure 46.

PC BOARD LAYOUT-SILK SCREEN

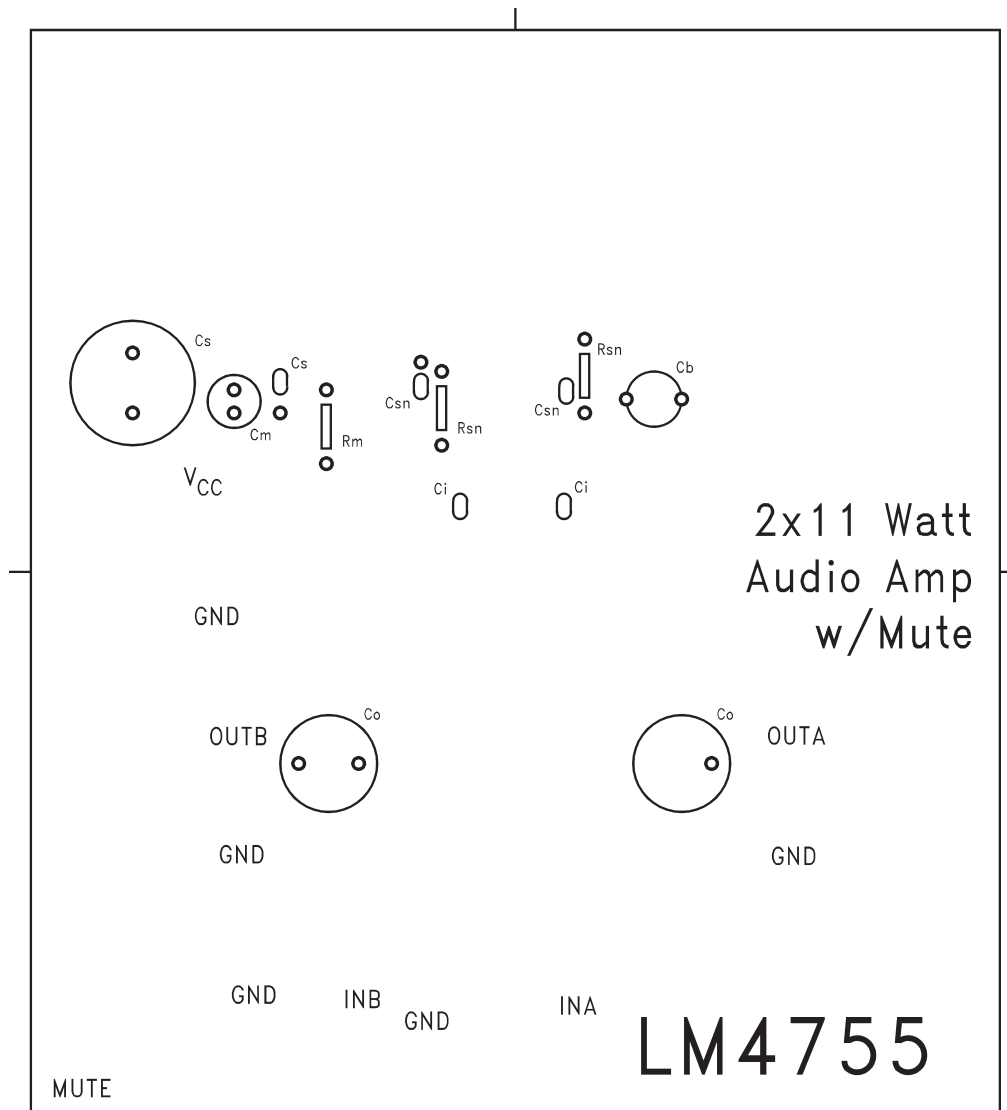


Figure 47.

PC BOARD LAYOUT-SOLDER SIDE

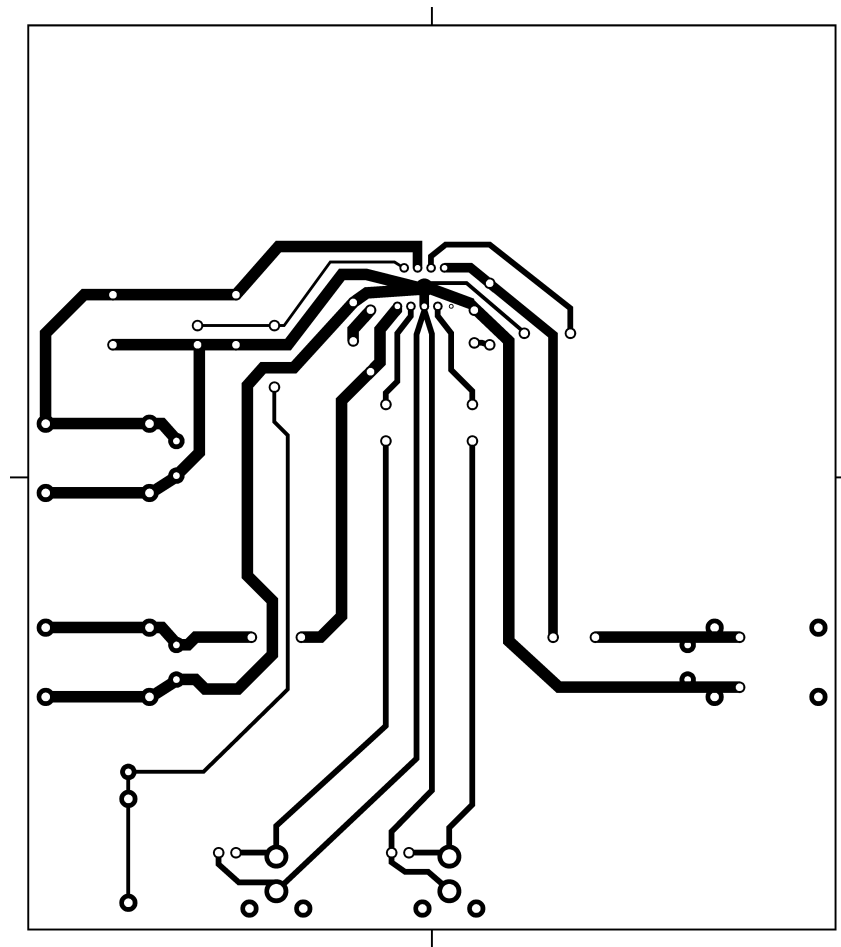


Figure 48.

---

**REVISION HISTORY**

<b>Changes from Revision D (April 2013) to Revision E</b>	<b>Page</b>
<hr/> <ul style="list-style-type: none"><li>• Changed layout of National Data Sheet to TI format .....</li></ul>	<hr/> <a href="#">22</a>

**PACKAGING INFORMATION**

Orderable Device	Status (1)	Package Type	Package Drawing	Pins	Package Qty	Eco Plan (2)	Lead/Ball Finish (6)	MSL Peak Temp (3)	Op Temp (°C)	Device Marking (4/5)	Samples
LM4755TSX/NOPB	ACTIVE	DDPAK/ TO-263	KTW	9	500	Pb-Free (RoHS Exempt)	CU SN	Level-3-245C-168 HR	-20 to 80	LM4755TS	Samples

(1) The marketing status values are defined as follows:

**ACTIVE:** Product device recommended for new designs.

**LIFEBUY:** TI has announced that the device will be discontinued, and a lifetime-buy period is in effect.

**NRND:** Not recommended for new designs. Device is in production to support existing customers, but TI does not recommend using this part in a new design.

**PREVIEW:** Device has been announced but is not in production. Samples may or may not be available.

**OBSELETE:** TI has discontinued the production of the device.

(2) Eco Plan - The planned eco-friendly classification: Pb-Free (RoHS), Pb-Free (RoHS Exempt), or Green (RoHS & no Sb/Br) - please check <http://www.ti.com/productcontent> for the latest availability information and additional product content details.

**TBD:** The Pb-Free/Green conversion plan has not been defined.

**Pb-Free (RoHS):** TI's terms "Lead-Free" or "Pb-Free" mean semiconductor products that are compatible with the current RoHS requirements for all 6 substances, including the requirement that lead not exceed 0.1% by weight in homogeneous materials. Where designed to be soldered at high temperatures, TI Pb-Free products are suitable for use in specified lead-free processes.

**Pb-Free (RoHS Exempt):** This component has a RoHS exemption for either 1) lead-based flip-chip solder bumps used between the die and package, or 2) lead-based die adhesive used between the die and leadframe. The component is otherwise considered Pb-Free (RoHS compatible) as defined above.

**Green (RoHS & no Sb/Br):** TI defines "Green" to mean Pb-Free (RoHS compatible), and free of Bromine (Br) and Antimony (Sb) based flame retardants (Br or Sb do not exceed 0.1% by weight in homogeneous material)

(3) MSL, Peak Temp. - The Moisture Sensitivity Level rating according to the JEDEC industry standard classifications, and peak solder temperature.

(4) There may be additional marking, which relates to the logo, the lot trace code information, or the environmental category on the device.

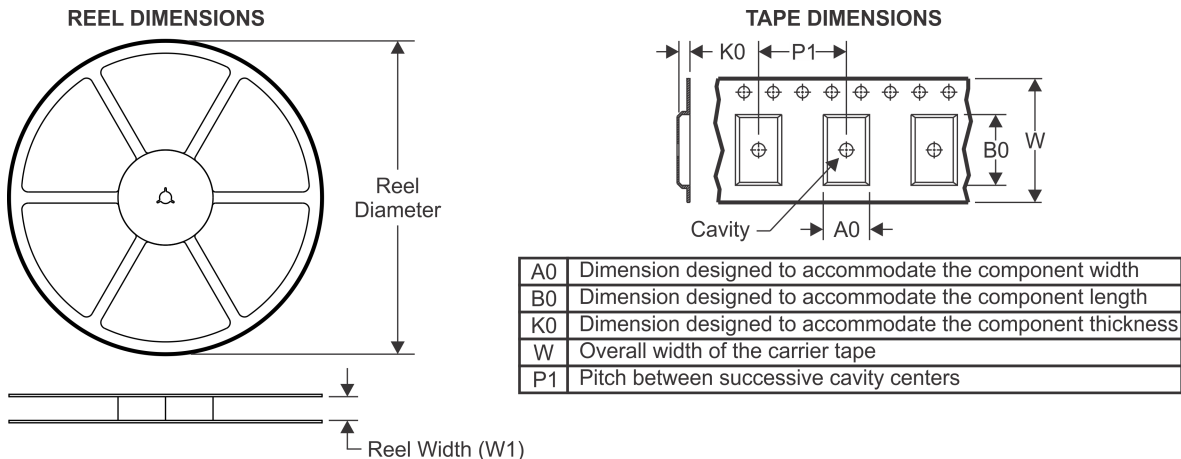
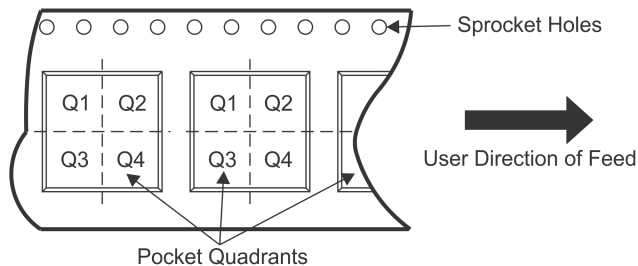
(5) Multiple Device Markings will be inside parentheses. Only one Device Marking contained in parentheses and separated by a "-" will appear on a device. If a line is indented then it is a continuation of the previous line and the two combined represent the entire Device Marking for that device.

(6) Lead/Ball Finish - Orderable Devices may have multiple material finish options. Finish options are separated by a vertical ruled line. Lead/Ball Finish values may wrap to two lines if the finish value exceeds the maximum column width.

**Important Information and Disclaimer:** The information provided on this page represents TI's knowledge and belief as of the date that it is provided. TI bases its knowledge and belief on information provided by third parties, and makes no representation or warranty as to the accuracy of such information. Efforts are underway to better integrate information from third parties. TI has taken and continues to take reasonable steps to provide representative and accurate information but may not have conducted destructive testing or chemical analysis on incoming materials and chemicals. TI and TI suppliers consider certain information to be proprietary, and thus CAS numbers and other limited information may not be available for release.

In no event shall TI's liability arising out of such information exceed the total purchase price of the TI part(s) at issue in this document sold by TI to Customer on an annual basis.



**TAPE AND REEL INFORMATION**

**QUADRANT ASSIGNMENTS FOR PIN 1 ORIENTATION IN TAPE**


\*All dimensions are nominal

Device	Package Type	Package Drawing	Pins	SPQ	Reel Diameter (mm)	Reel Width W1 (mm)	A0 (mm)	B0 (mm)	K0 (mm)	P1 (mm)	W (mm)	Pin1 Quadrant
LM4755TSX/NOPB	DDPAK/TO-263	KTW	9	500	330.0	24.4	10.75	14.85	5.0	16.0	24.0	Q2

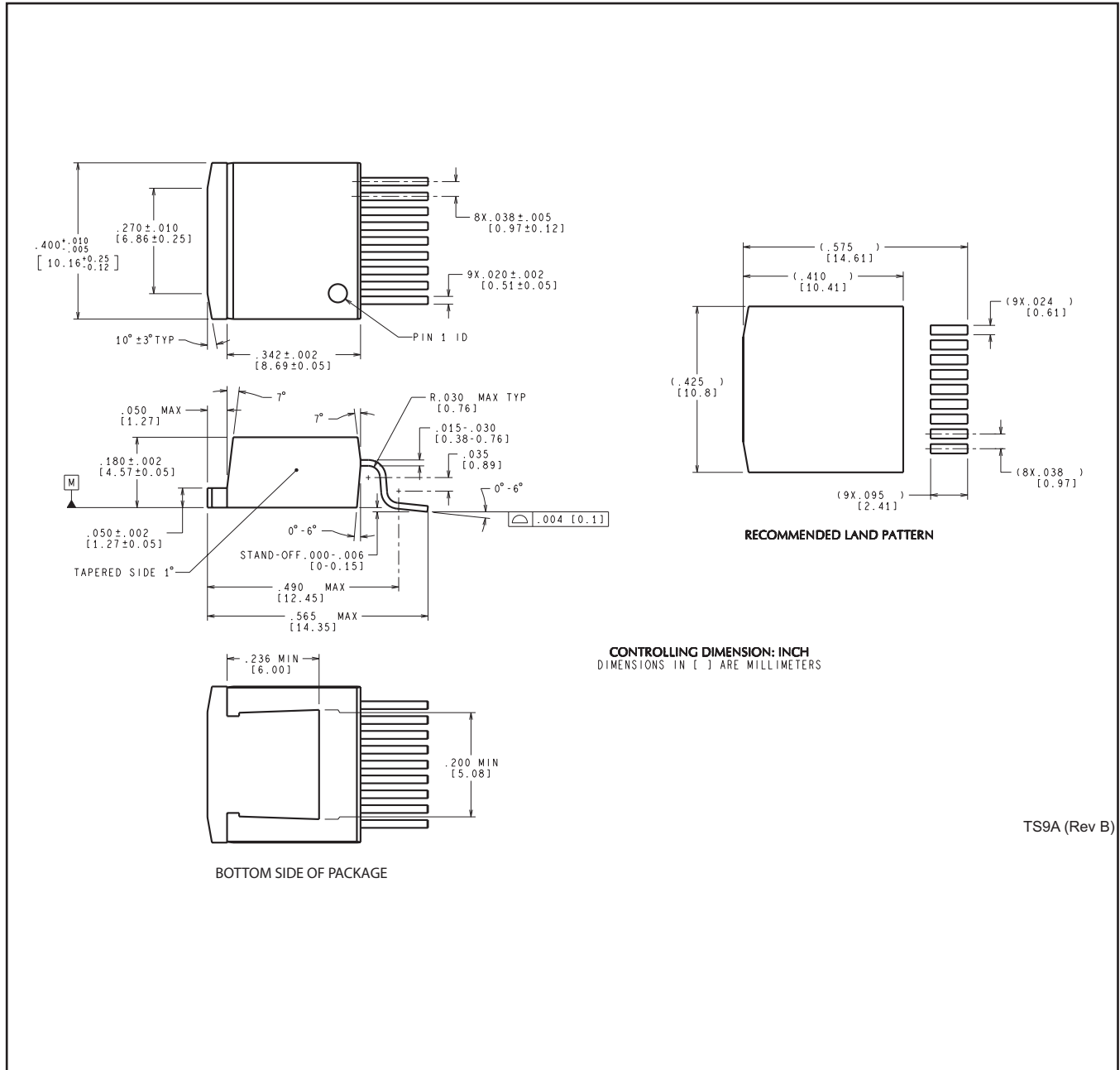
TAPE AND REEL BOX DIMENSIONS



\*All dimensions are nominal

Device	Package Type	Package Drawing	Pins	SPQ	Length (mm)	Width (mm)	Height (mm)
LM4755TSX/NOPB	DDPAK/TO-263	KTW	9	500	367.0	367.0	45.0

KTW0009A



CONTROLLING DIMENSION: INCH  
DIMENSIONS IN ( ) ARE MILLIMETERS

TS9A (Rev B)

## IMPORTANT NOTICE

Texas Instruments Incorporated and its subsidiaries (TI) reserve the right to make corrections, enhancements, improvements and other changes to its semiconductor products and services per JESD46, latest issue, and to discontinue any product or service per JESD48, latest issue. Buyers should obtain the latest relevant information before placing orders and should verify that such information is current and complete. All semiconductor products (also referred to herein as "components") are sold subject to TI's terms and conditions of sale supplied at the time of order acknowledgment.

TI warrants performance of its components to the specifications applicable at the time of sale, in accordance with the warranty in TI's terms and conditions of sale of semiconductor products. Testing and other quality control techniques are used to the extent TI deems necessary to support this warranty. Except where mandated by applicable law, testing of all parameters of each component is not necessarily performed.

TI assumes no liability for applications assistance or the design of Buyers' products. Buyers are responsible for their products and applications using TI components. To minimize the risks associated with Buyers' products and applications, Buyers should provide adequate design and operating safeguards.

TI does not warrant or represent that any license, either express or implied, is granted under any patent right, copyright, mask work right, or other intellectual property right relating to any combination, machine, or process in which TI components or services are used. Information published by TI regarding third-party products or services does not constitute a license to use such products or services or a warranty or endorsement thereof. Use of such information may require a license from a third party under the patents or other intellectual property of the third party, or a license from TI under the patents or other intellectual property of TI.

Reproduction of significant portions of TI information in TI data books or data sheets is permissible only if reproduction is without alteration and is accompanied by all associated warranties, conditions, limitations, and notices. TI is not responsible or liable for such altered documentation. Information of third parties may be subject to additional restrictions.

Resale of TI components or services with statements different from or beyond the parameters stated by TI for that component or service voids all express and any implied warranties for the associated TI component or service and is an unfair and deceptive business practice. TI is not responsible or liable for any such statements.

Buyer acknowledges and agrees that it is solely responsible for compliance with all legal, regulatory and safety-related requirements concerning its products, and any use of TI components in its applications, notwithstanding any applications-related information or support that may be provided by TI. Buyer represents and agrees that it has all the necessary expertise to create and implement safeguards which anticipate dangerous consequences of failures, monitor failures and their consequences, lessen the likelihood of failures that might cause harm and take appropriate remedial actions. Buyer will fully indemnify TI and its representatives against any damages arising out of the use of any TI components in safety-critical applications.

In some cases, TI components may be promoted specifically to facilitate safety-related applications. With such components, TI's goal is to help enable customers to design and create their own end-product solutions that meet applicable functional safety standards and requirements. Nonetheless, such components are subject to these terms.

No TI components are authorized for use in FDA Class III (or similar life-critical medical equipment) unless authorized officers of the parties have executed a special agreement specifically governing such use.

Only those TI components which TI has specifically designated as military grade or "enhanced plastic" are designed and intended for use in military/aerospace applications or environments. Buyer acknowledges and agrees that any military or aerospace use of TI components which have **not** been so designated is solely at the Buyer's risk, and that Buyer is solely responsible for compliance with all legal and regulatory requirements in connection with such use.

TI has specifically designated certain components as meeting ISO/TS16949 requirements, mainly for automotive use. In any case of use of non-designated products, TI will not be responsible for any failure to meet ISO/TS16949.

### Products

Audio	<a href="http://www.ti.com/audio">www.ti.com/audio</a>
Amplifiers	<a href="http://amplifier.ti.com">amplifier.ti.com</a>
Data Converters	<a href="http://dataconverter.ti.com">dataconverter.ti.com</a>
DLP® Products	<a href="http://www.dlp.com">www.dlp.com</a>
DSP	<a href="http://dsp.ti.com">dsp.ti.com</a>
Clocks and Timers	<a href="http://www.ti.com/clocks">www.ti.com/clocks</a>
Interface	<a href="http://interface.ti.com">interface.ti.com</a>
Logic	<a href="http://logic.ti.com">logic.ti.com</a>
Power Mgmt	<a href="http://power.ti.com">power.ti.com</a>
Microcontrollers	<a href="http://microcontroller.ti.com">microcontroller.ti.com</a>
RFID	<a href="http://www.ti-rfid.com">www.ti-rfid.com</a>
OMAP Applications Processors	<a href="http://www.ti.com/omap">www.ti.com/omap</a>
Wireless Connectivity	<a href="http://www.ti.com/wirelessconnectivity">www.ti.com/wirelessconnectivity</a>

### Applications



Automotive and Transportation	<a href="http://www.ti.com/automotive">www.ti.com/automotive</a>
Communications and Telecom	<a href="http://www.ti.com/communications">www.ti.com/communications</a>
Computers and Peripherals	<a href="http://www.ti.com/computers">www.ti.com/computers</a>
Consumer Electronics	<a href="http://www.ti.com/consumer-apps">www.ti.com/consumer-apps</a>
Energy and Lighting	<a href="http://www.ti.com/energy">www.ti.com/energy</a>
Industrial	<a href="http://www.ti.com/industrial">www.ti.com/industrial</a>
Medical	<a href="http://www.ti.com/medical">www.ti.com/medical</a>
Security	<a href="http://www.ti.com/security">www.ti.com/security</a>
Space, Avionics and Defense	<a href="http://www.ti.com/space-avionics-defense">www.ti.com/space-avionics-defense</a>
Video and Imaging	<a href="http://www.ti.com/video">www.ti.com/video</a>

### TI E2E Community

[e2e.ti.com](http://e2e.ti.com)

## Looking for pricing, stock, or lifecycle information?

Click below to explore more details on WIN SOURCE:

-  [View LM4755TSX/NOPB on WIN SOURCE](#)
-  [Texas Instruments](#) Information

## Optimize Your Supply Chain with WIN SOURCE Solutions

-  Global Sourcing Solution
-  Obsolete Management
-  Cost Control Management
-  Shortage Management
-  Alternative Solution
-  Excess Inventory Management