



**THE DATASHEET OF
LM4680SD/NOPB**



LM4680 Boomer® Audio Power Amplifier Series 10W High-Efficiency Mono BTL Audio Power Amplifier

Check for Samples: [LM4680](#)

FEATURES

- Soft-Start Circuitry Eliminates Noise During Turn-On Transition
- Low Current Shutdown Mode
- Low Quiescent Current
- 6W BTL Output, $R_L = 8\Omega$, THD+N = 1%
- Short Circuit Protection
- Fixed, Internally Set Gain of 30dB
- Internal Clamp Diodes Protect Amplifier Outputs

KEY SPECIFICATIONS

- Power Output BTL ($V_{DD} = 14V$, $f_{IN} = 1kHz$, THD+N = 10%, $R_L = 8\Omega$): 10W (typ)
- Quiescent Power Supply Current: 25mA (typ)
- Efficiency ($V_{DD} = 12V$, $f_{IN} = 1kHz$, $R_L = 8\Omega$, $P_{OUT} = 6W$): 81% (typ)
- Shutdown Current: 0.1mA (typ)
- Fixed Gain: 30dB (typ)

APPLICATIONS

- Flat Panel Monitors
- Flat Panel TVs
- Computer Sound Cards

DESCRIPTION

The LM4680 is a high efficiency switching audio power amplifier primarily designed for demanding applications in flat panel monitors and TV's. It is capable of delivering 10W to an 8Ω mono BTL load with less than 10% distortion (THD+N) when powered from a $14V_{DC}$ power supply.

Boomer audio power amplifiers were designed specifically to provide high quality output power with a minimal amount of external components. The LM4680 features a micro-power, active-low shutdown mode, an internal thermal shutdown protection mechanism, output fault detect, and short circuit protection.

The LM4680 contains advanced transient (“pop and click”) suppression circuitry that eliminates noises that would otherwise occur during turn-on and turn-off transitions.

Connection Diagram

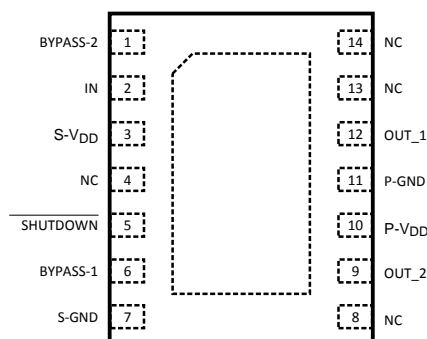

**Figure 1. Top View
14-Pin VSSOP
See NHM0014A Package**



Please be aware that an important notice concerning availability, standard warranty, and use in critical applications of Texas Instruments semiconductor products and disclaimers thereto appears at the end of this data sheet.

All trademarks are the property of their respective owners.

Typical Application

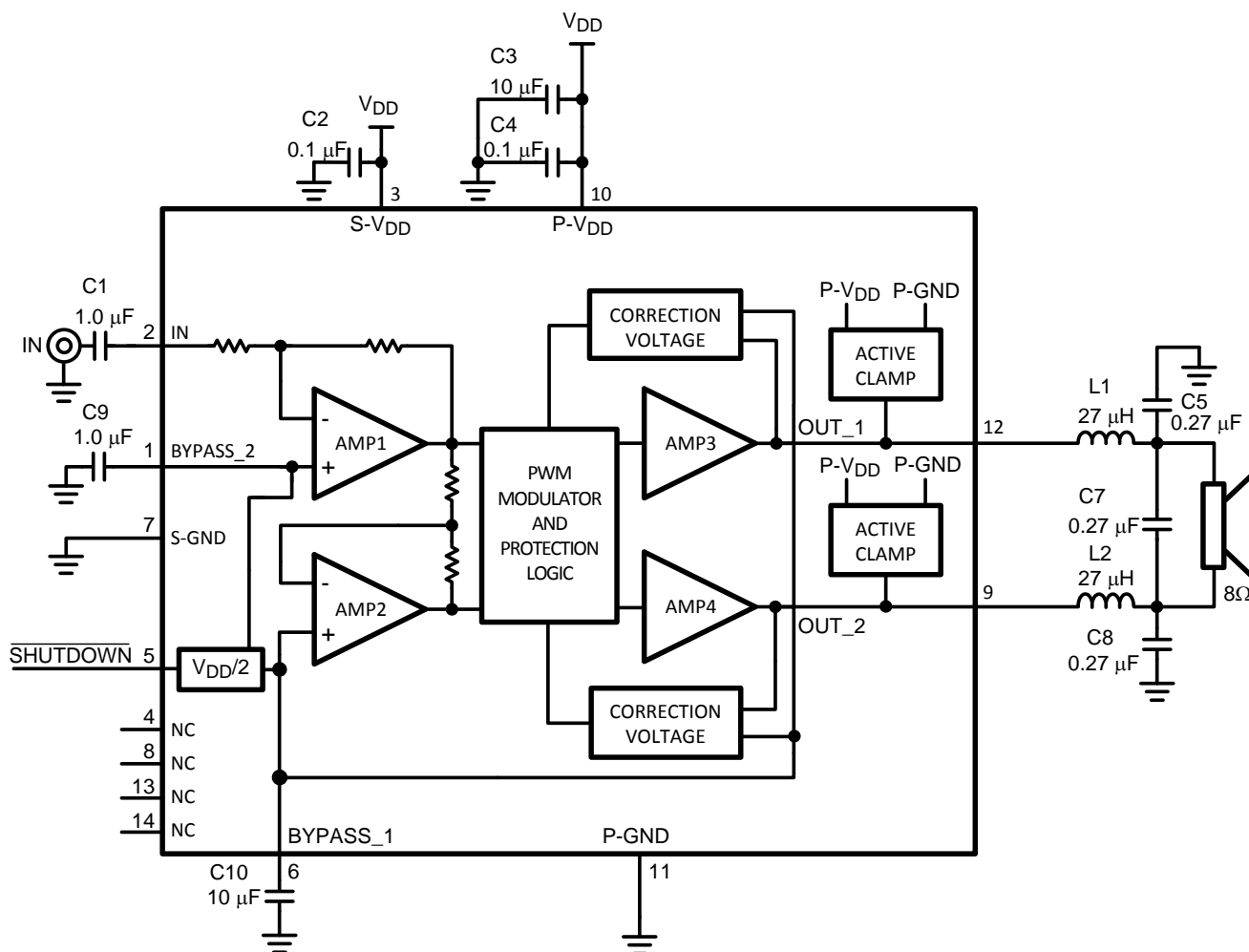

Figure 2. Typical Audio Amplifier Application Circuit

LM4680SD Demo Board Bill of Material

Item	Part Description	Package Size	Qty	Ref Designator	Remark	Supplier
1	LM4680SD Audio Amplifier	LLP14	1	U1		
2	Cer Cap 0.1μF 16V 10%	0805	1	C4	PCC1812CT-ND	Digi - Key
3	Cer Cap 0.27μF 16V 10%	0805	3	C5, C7, C8	PCC1916CT-ND	Digi - Key
4	Cer Cap 1.0μF 25V 10%	0805	2	C1 - C2	PCC2319CT-ND	Digi - Key
5	Tant Cap 1.0μF 16V 10%	Size = A (3216)	2	C9	399-1583-2-ND	Digi - Key
6	Tant Cap 10.0μF 16V 10%	Size = A (3216)	2	C10	478-1655-2-ND	Digi - Key
7	Tant Cap 10.0μF 16V 10%	Size = A (3216)	1	C3	478-1655-2-ND	Digi - Key
8	Inductor 4922 Series 27μH SMT		2	L1, L2	DN2218CT-ND	Digi - Key



These devices have limited built-in ESD protection. The leads should be shorted together or the device placed in conductive foam during storage or handling to prevent electrostatic damage to the MOS gates.

Absolute Maximum Ratings⁽¹⁾⁽²⁾

Supply Voltage		16V
Storage Temperature		-65°C to +150°C
Input Voltage		-0.3V to $V_{DD} + 0.3V$
Power Dissipation ⁽³⁾		Internally limited
ESD Susceptibility ⁽⁴⁾		2000V
ESD Susceptibility ⁽⁵⁾		200V
Junction Temperature		150°C
Thermal Resistance	θ_{JC}	2°C/W
	θ_{JA}	40°C/W

- (1) All voltages are measured with respect to the GND pin unless otherwise specified.
- (2) Absolute Maximum Ratings indicate limits beyond which damage to the device may occur. Operating Ratings indicate conditions for which the device is functional, but do not ensure specific performance limits. Electrical Characteristics state DC and AC electrical specifications under particular test conditions which specify performance limits. This assumes that the device is within the Operating Ratings. Specifications are not ensured for parameters where no limit is given, however, the typical value is a good indication of device performance.
- (3) The maximum power dissipation must be derated at elevated temperatures and is dictated by T_{JMAX} , θ_{JA} , and the ambient temperature T_A . The maximum allowable power dissipation is $P_{DMAX} = (T_{JMAX} - T_A)/\theta_{JA}$ or the number given in [Absolute Maximum Ratings](#), whichever is lower. For the LM4680 typical application (shown in [Figure 2](#)) with $V_{DD} = 12V$, $R_L = 8\Omega$ stereo operation, the total power dissipation is 900mW. $\theta_{JA} = 40^\circ C/W$
- (4) Human body model, 100pF discharged through a 1.5k Ω resistor.
- (5) Machine model, 220pF – 240pF discharged through all pins.

Operating Ratings

Temperature Range		
$T_{MIN} \leq T_A \leq T_{MAX}$		-40°C $\leq T_A \leq$ 85°C
Supply Voltage ⁽¹⁾		9.0V $\leq V_{DD} \leq$ 14V

- (1) Please refer to [Under Voltage Protection](#) under [General Features](#).

Electrical Characteristics for the LM4680⁽¹⁾

The following specifications apply for the circuit shown in [Figure 2](#) operating with $V_{DD} = 12V$, $R_L = 8\Omega$, and $f_{IN} = 1kHz$, unless otherwise specified. Limits apply for $T_A = 25^\circ C$.

Symbol	Parameter	Conditions	LM4680		Units (Limits)
			Typical ⁽²⁾	Limit ⁽³⁾⁽⁴⁾	
I_{DD}	Quiescent Power Supply Current	$V_{IN} = 0V$, $I_O = 0A$, $R_L = 8\Omega$	28	52	mA
I_{SD}	Shutdown Current	$V_{SHUTDOWN} = GND^{(5)}$	0.1		mA
A_V	Amplifier Gain	BTL output voltage with respect to input voltage	30		dB
P_O	Output Power	THD+N = 1% (max) THD+N = 10%, $V_{DD} = 14V$	6 10	5	W
THD+N	Total Harmonic Distortion + Noise	$P_{OUT} = 1W_{RMS}$	0.2		%
f_{BW}	Frequency Response Bandwidth	$P_{OUT} = 6W$, post filter, -3dB relative to 1kHz	20 20000		Hz Hz
η	Efficiency	$P_{OUT} = 6W$	81		%
ϵ_N	Output Noise	A-Weighted Filter, $V_{IN} = 0V$, Input Referred	10		μV
SNR	Signal-to-Noise Ratio	A-Weighted Filter, $P_{OUT} = 6W$ Input Referred	116		dB
PSRR	Power Supply Rejection Ratio	$V_{RIPPLE} = 200mV_{p-p}$, $C_{BYPASS_1} = 10\mu F$, Input Referred $f = 50Hz$ $f = 60Hz$ $f = 100Hz$ $f = 120Hz$ $f = 1kHz$	99 101 102 102 104		dB
t_{WU}	Wake-Up time	$C_{BYPASS} = 10\mu F$	600		ms
T_{SD}	Thermal Shutdown Temperature		170		$^\circ C$ $^\circ C$
V_{SDIH}	Shutdown Voltage Input High			4	V (min)
V_{SDIL}	Shutdown Voltage Input Low			1.5	V (max)

- (1) All voltages are measured with respect to the GND pin unless otherwise specified.
- (2) Typicals are measured at $25^\circ C$ and represent the parametric norm.
- (3) Limits are ensured to AOQL (Average Outgoing Quality Level).
- (4) Data sheets min and max specification limits are specified by design, test, or statistical analysis.
- (5) Shutdown current is measured in a normal room environment. The SHUTDOWN pin should be driven as close as possible to GND for minimum shutdown current.

Typical Performance Characteristics

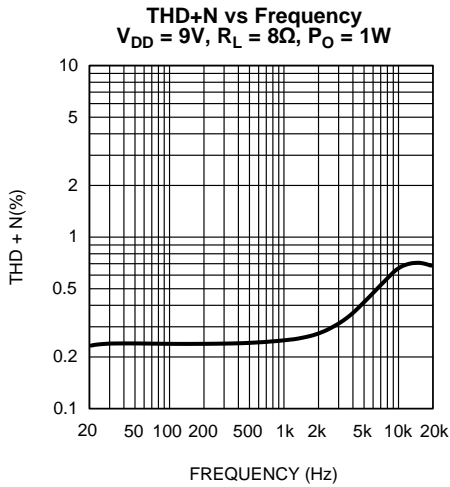

Figure 3.

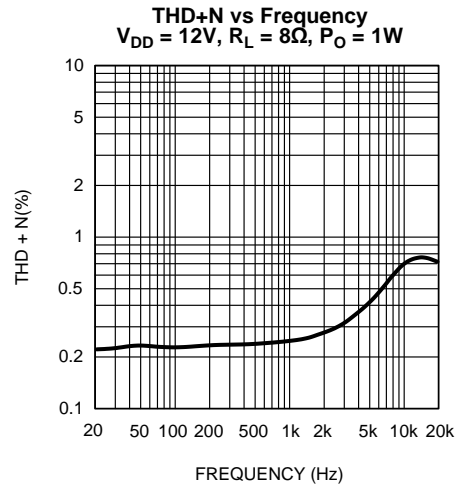

Figure 4.

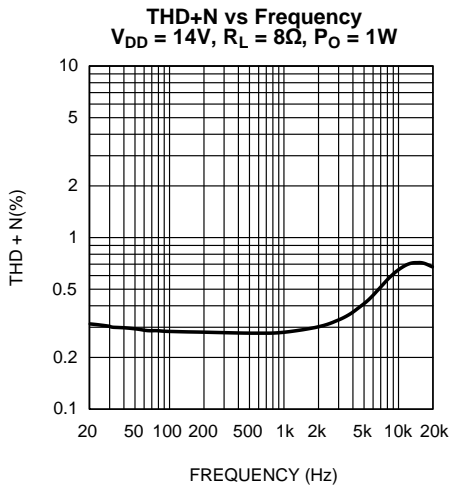

Figure 5.

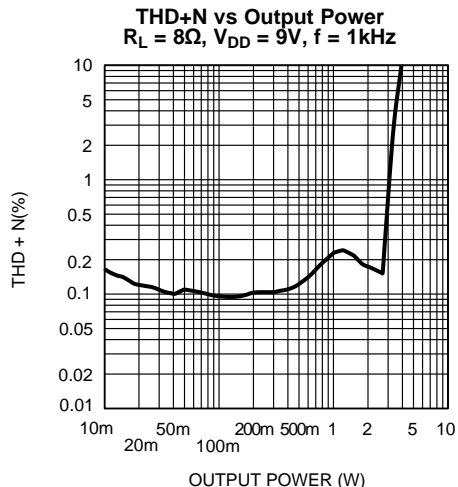

Figure 6.

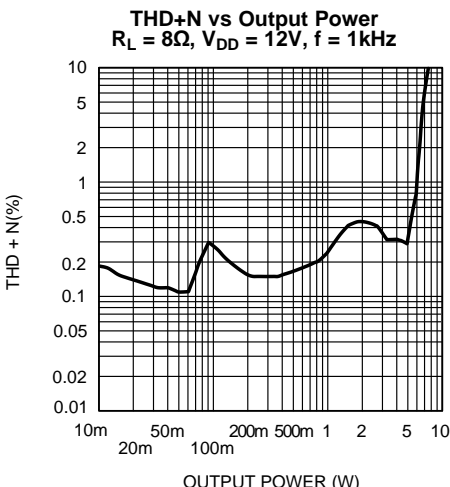

Figure 7.

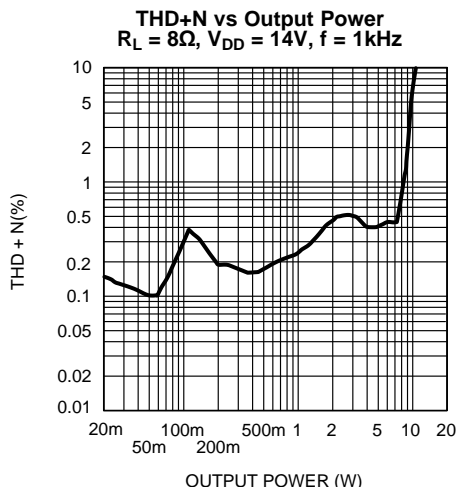

Figure 8.

Typical Performance Characteristics (continued)

Amplifier Output Power vs Power Supply Voltage
 $R_L = 8\Omega, f = 1\text{kHz}$

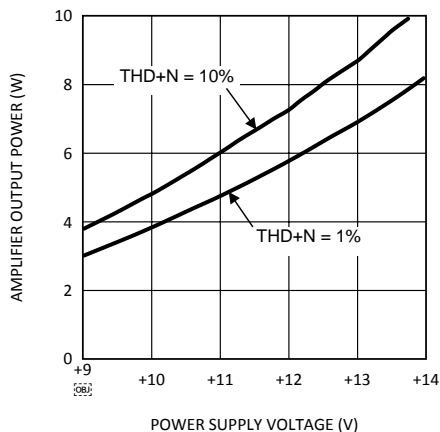

Figure 9.

Amplifier Output Magnitude vs Frequency
 $R_L = 8\Omega, V_{DD} = 12\text{V}$

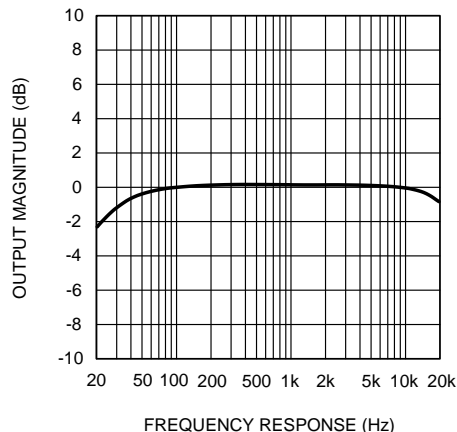

Figure 10.

Power Rejection Ratio vs Frequency
 $V_{DD} = 9\text{V}, R_L = 8\Omega, \text{Input Referred}$

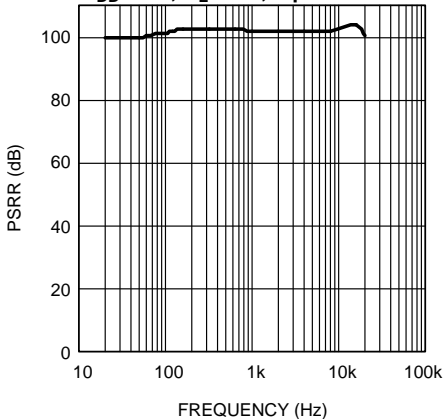

Figure 11.

Power Rejection Ratio vs Frequency
 $V_{DD} = 12\text{V}, R_L = 8\Omega, \text{Input Referred}$

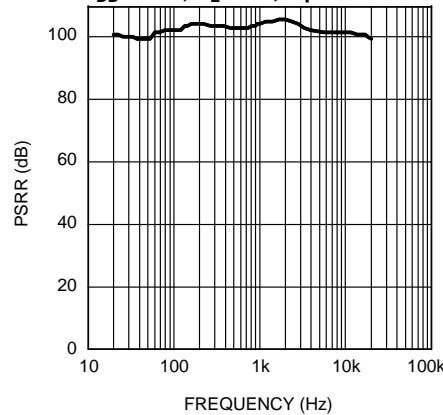

Figure 12.

Power Rejection Ratio vs Frequency
 $V_{DD} = 14\text{V}, R_L = 8\Omega, \text{Input Referred}$

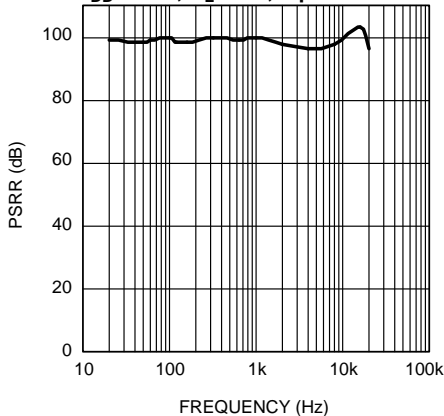

Figure 13.

Amplifier Power Dissipation vs Amplifier Load Dissipation
 $V_{DD} = 14\text{V}, R_L = 8\Omega, f = 1\text{kHz}$

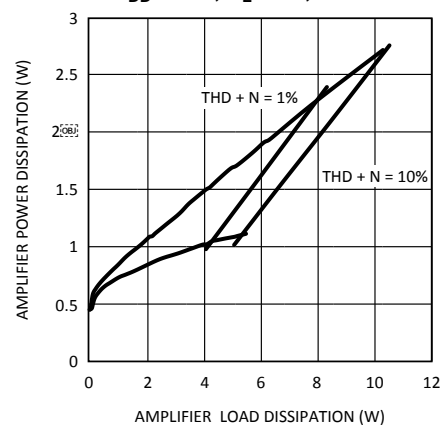

Figure 14.

Typical Performance Characteristics (continued)

Amplifier Power Dissipation vs Load Power Dissipation
 $V_{DD} = 12V, R_L = 8\Omega, f = 1kHz$

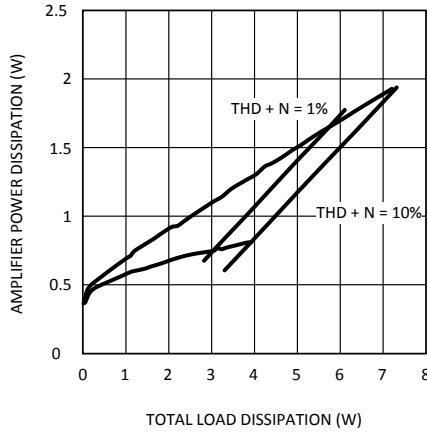

Figure 15.

Amplifier Power Dissipation vs Total Load Power Dissipation
 $V_{DD} = 9V, R_L = 8\Omega, f = 1kHz$

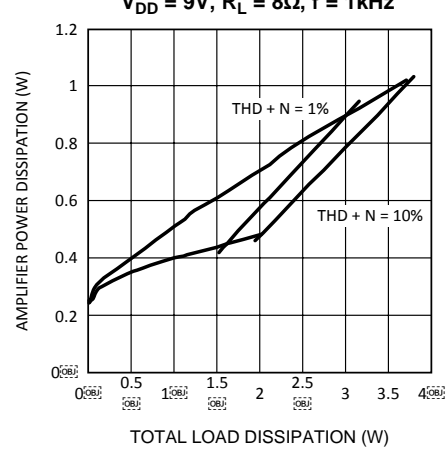

Figure 16.

Output Power vs Load Resistance
 $V_{DD} = 14V, f = 1kHz$

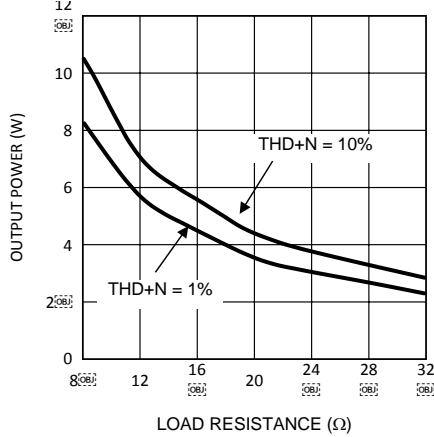

Figure 17.

Output Power vs Load Resistance
 $V_{DD} = 12V, f = 1kHz$

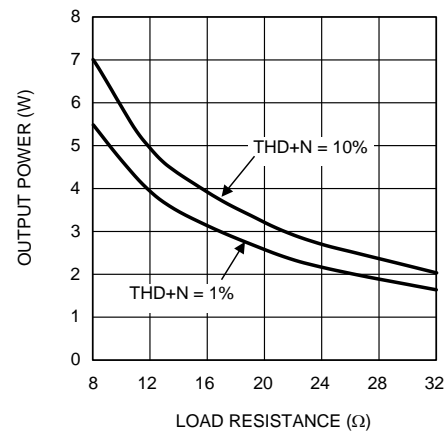

Figure 18.

Output Power vs Load Resistance
 $V_{DD} = 9V, f = 1kHz$

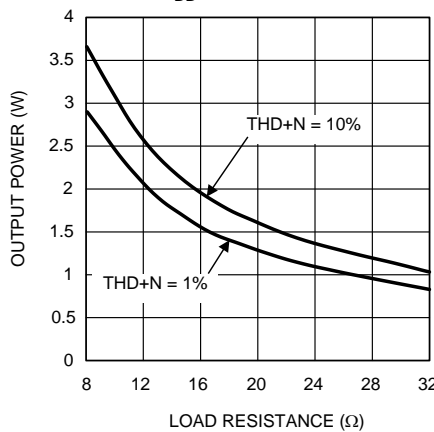

Figure 19.

Power Supply Current vs Power Supply Voltage
 $V_{IN} = 0V, R_L = 8\Omega$

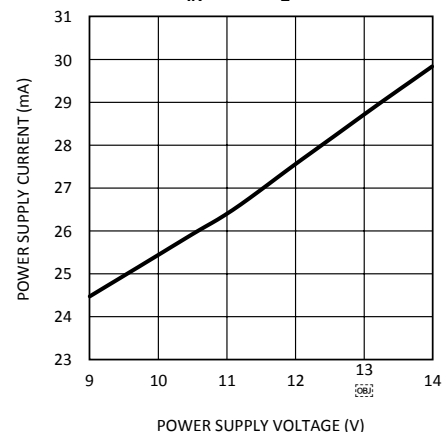

Figure 20.

Typical Performance Characteristics (continued) Power Dissipation vs Ambient Temperature

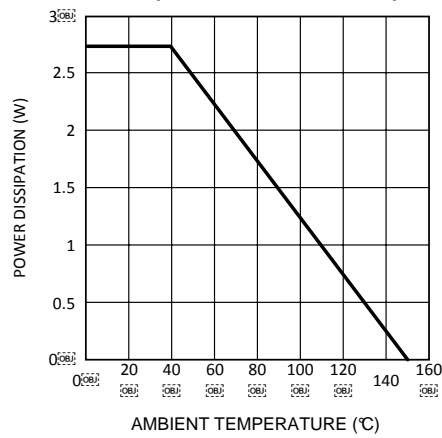

Figure 21.

GENERAL FEATURES

SYSTEM FUNCTIONAL INFORMATION

Modulation Technique

Unlike typical Class D amplifiers that use single-ended comparators to generate a pulse-width modulated switching waveform and RC timing circuits to set the switching frequency, the LM4680 uses a balanced differential floating modulator. Oscillation is a result of injecting complimentary currents onto the respective plates of a floating, on-die capacitor. The value of the floating capacitor and value of the components in the modulator's feedback network and sets the nominal switching frequency at 450kHz. Modulation results from imbalances in the injected currents. The amount of current imbalance is directly proportional to the applied input signal's magnitude and frequency.

Using a balanced, floating modulator produces a Class D amplifier that is immune to common mode noise sources such as substrate noise. This noise occurs because of the high frequency, high current switching in the amplifier's output stage. The LM4680 is immune to this type of noise because the modulator, the components that set its switching frequency, and even the load all float with respect to ground.

The balanced modulator's pulse width modulated output drives the gates of the LM4680's H-bridge configured output power MOSFETs. The pulse-train present at the power MOSFETs' output is applied to an LC low pass filter that removes the 450kHz energy component. The filter's output signal, which is applied to the driven load, is an amplified replica of the audio input signal.

Shutdown Function

The LM4680's active-low shutdown function allows the user to place the amplifier in a shutdown mode while the system power supply remains active. Activating shutdown deactivates the output switching waveform and minimizes the quiescent current. Applying logic 0 (GND) to pin 8 enables the shutdown function. Applying logic 1 ($4V \leq V_{\text{LOGIC}} \leq V_{\text{DD}}$) to pin 8 disables the shutdown function and restores full amplifier operation.

Under Voltage Protection

The under voltage protection disables the output driver section of the LM4680 while the supply voltage is below 8V. This condition may occur as power is first applied or during low line conditions, changes in load resistance, or when power supply sag occurs. The under voltage protection ensures that all of the LM4680's power MOSFETs are off. This action eliminates shoot-through current and minimizes output transients during turn-on and turn-off. The under voltage protection gives the digital logic time to stabilize into known states, further minimizing turn output transients.

Turn-On Time

The LM4680 has an internal timer that determines the amplifier's turn-on time. After power is first applied or the part returns from shutdown, the nominal turn-on time is 600ms. This delay allows all externally applied capacitors to charge to a final value of $V_{\text{DD}}/2$. Further, during turn-on, the outputs are muted. This minimizes output transients that may occur while the part settles into its quiescent operating mode.

Output Stage Current Limit and Fault Detection Protection

The output stage MOSFETs are protected against output conditions that could otherwise compromise their operational status. The first stage of protection is output current limiting. When conditions that require high currents to drive a load, the LM4680's current limit circuitry clamps the output current at a nominal value of 2.5A. The output waveform is present, but may be clipped or its amplitude reduced. The same 2.5A nominal current limit also occurs if the amplifier outputs are shorted together or either output is shorted to V_{DD} or GND.

The second stage of protection is an onboard fault detection circuit that continuously monitors the signal on each output MOSFET's gate and compares it against the respective drain voltage. When a condition is detected that violates a MOSFET's Safe Operating Area (SOA) and the drive signal is disconnected from the output MOSFETs' gates. The fault detect circuit maintains this protective condition for approximately 600ms, at which time the drive signal is reconnected. If the fault condition is no longer present, normal operation resumes. If the fault condition remains, however, the drive signal is again disconnected.

Thermal Protection

The LM4680 has thermal shutdown circuitry that monitors the die temperature. Once the LM4680 die temperature reaches 170°C, the LM4680 disables the output switching waveform and remains disabled until the die temperature falls below 140°C (typ).

Over-Modulation Protection

The LM4680's over-modulation protection is a result of the preamplifier's (AMP1 and AMP2, [Figure 2](#)) inability to produce signal magnitudes that equal the power supply voltages. Since the preamplifier's output magnitude will always be less than the supply voltage, the duty cycle of the amplifier's switching output will never reach zero. Peak modulation is limited to a nominal 95%.

APPLICATION INFORMATION

SUPPLY BYPASSING

Correct power supply bypassing has two important goals. The first is to reduce noise on the power supply lines and minimize deleterious effects that the noise may cause to the amplifier's operation. The second is to help stabilize an unregulated power supply and to improve the supply's transient response under heavy current demands. These two goals require different capacitor value ranges. Therefore, various types and values are recommended for supply bypassing. For noise de-coupling, generally small ceramic capacitors (0.01 μ F to 0.1 μ F) are recommended. Larger value (1 μ F to 10 μ F) tantalum capacitors are needed for the transient current demands. These two capacitors in parallel will do an adequate job of removing most noise from the supply rails and providing the necessary transient current. These capacitors should be placed as close as possible to each IC's supply pin(s) using leads as short as possible.

The LM4680 has two V_{DD} pins: a power V_{DD} (PV_{DD}) and a signal V_{DD} (SV_{DD}). The parallel combination of the low value ceramic (0.1 μ F) and high value tantalum (10 μ F) should be used to bypass the PV_{DD} pin. A small value (0.1 μ F) ceramic or tantalum can be used to bypass the SV_{DD} pin.

OUTPUT STAGE FILTERING

The LM4680 requires a low pass filter connected between the amplifier's bridge output and the load. [Figure 2](#) shows the recommended LC filter. A minimum value of 27 μ H is recommended. As shown in [Figure 2](#), using the values of the components connected between the amplifier BTL outputs and the load achieves a 2nd-order lowpass filter response with a -3dB cutoff frequency of 25kHz.

THD+N MEASUREMENTS AND OUT OF AUDIO BAND NOISE

THD+N (Total Harmonic Distortion plus Noise) is a very important parameter by which all audio amplifiers are measured. Often it is shown as a graph where either the output power or frequency is changed over the operating range. A very important variable in the measurement of THD+N is the bandwidth-limiting filter at the input of the test equipment. Class D amplifiers, by design, switch their output power devices at a much higher frequency than the accepted audio range (20Hz - 20kHz). Alternately switching the output voltage between V_{DD} and GND allows the LM4680 to operate at much higher efficiency than that achieved by traditional Class AB amplifiers. Switching the outputs at high frequency also increases the out-of-band noise. Under normal circumstances the output lowpass filter significantly reduces this out-of-band noise. If the low pass filter is not optimized for a given switching frequency, there can be significant increase in out-of-band noise. THD+N measurements can be significantly affected by out-of-band noise, resulting in a higher than expected THD+N measurement. To achieve a more accurate measurement of THD, the test equipment's input bandwidth of the must be limited. Some common upper filter points are 22kHz, 30kHz, and 80kHz. The input filter limits the noise component of the THD+N measurement to a smaller bandwidth resulting in a more real-world THD+N value.

Recommended Printed Circuit Board Layout

Figure 22, Figure 23, and Figure 24 show the recommended two-layer PC board layout that is optimized for the 14-pin NHM0014A packaged LM4680 and associated external components. This circuit is designed for use with an external 12V supply and 8W speakers (or load resistors). This circuit board is easy to use. Apply 12V and ground to the board's V_{DD} and GND terminals, respectively. Connect speakers (or load resistors) between the board's -OUT and +OUT terminals. Apply the input signal to the input pin labeled -IN.

Demonstration Board Layout

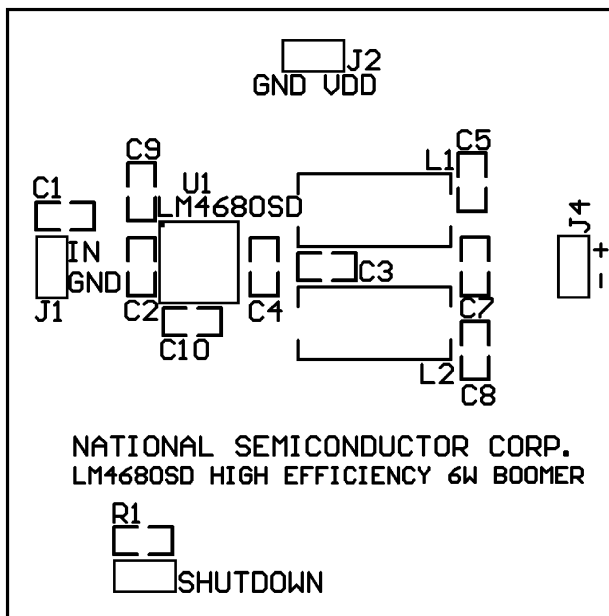

Figure 22. Recommended SD PCB Layout
Top Silkscreen

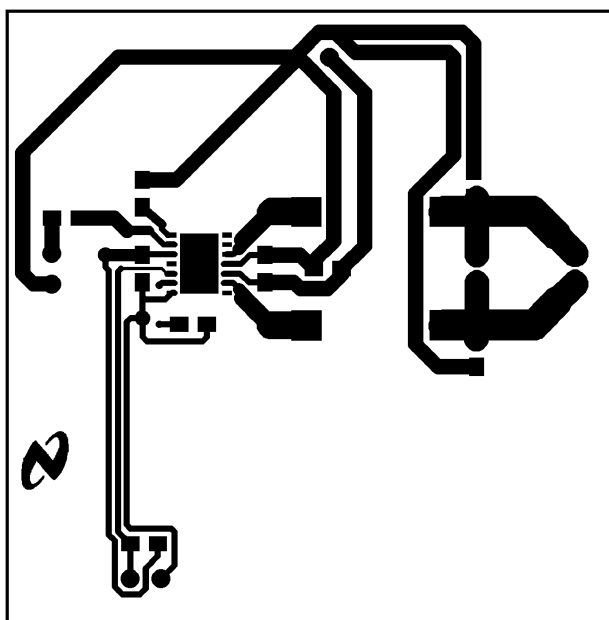

Figure 23. Recommended SD PCB Layout
Top Layer

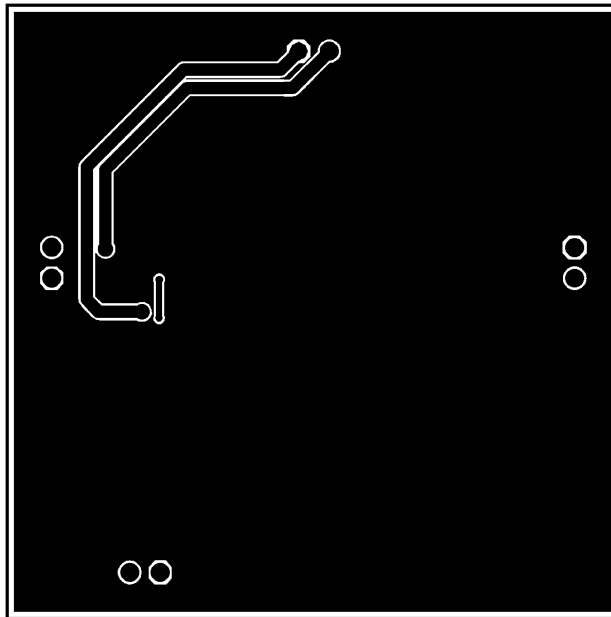

Figure 24. Recommended SD PCB Layout
Bottom Layer

REVISION HISTORY

Changes from Original (April 2013) to Revision A	Page
• Changed layout of National Data Sheet to TI format	13

IMPORTANT NOTICE

Texas Instruments Incorporated and its subsidiaries (TI) reserve the right to make corrections, enhancements, improvements and other changes to its semiconductor products and services per JESD46, latest issue, and to discontinue any product or service per JESD48, latest issue. Buyers should obtain the latest relevant information before placing orders and should verify that such information is current and complete. All semiconductor products (also referred to herein as "components") are sold subject to TI's terms and conditions of sale supplied at the time of order acknowledgment.

TI warrants performance of its components to the specifications applicable at the time of sale, in accordance with the warranty in TI's terms and conditions of sale of semiconductor products. Testing and other quality control techniques are used to the extent TI deems necessary to support this warranty. Except where mandated by applicable law, testing of all parameters of each component is not necessarily performed.

TI assumes no liability for applications assistance or the design of Buyers' products. Buyers are responsible for their products and applications using TI components. To minimize the risks associated with Buyers' products and applications, Buyers should provide adequate design and operating safeguards.

TI does not warrant or represent that any license, either express or implied, is granted under any patent right, copyright, mask work right, or other intellectual property right relating to any combination, machine, or process in which TI components or services are used. Information published by TI regarding third-party products or services does not constitute a license to use such products or services or a warranty or endorsement thereof. Use of such information may require a license from a third party under the patents or other intellectual property of the third party, or a license from TI under the patents or other intellectual property of TI.

Reproduction of significant portions of TI information in TI data books or data sheets is permissible only if reproduction is without alteration and is accompanied by all associated warranties, conditions, limitations, and notices. TI is not responsible or liable for such altered documentation. Information of third parties may be subject to additional restrictions.

Resale of TI components or services with statements different from or beyond the parameters stated by TI for that component or service voids all express and any implied warranties for the associated TI component or service and is an unfair and deceptive business practice. TI is not responsible or liable for any such statements.

Buyer acknowledges and agrees that it is solely responsible for compliance with all legal, regulatory and safety-related requirements concerning its products, and any use of TI components in its applications, notwithstanding any applications-related information or support that may be provided by TI. Buyer represents and agrees that it has all the necessary expertise to create and implement safeguards which anticipate dangerous consequences of failures, monitor failures and their consequences, lessen the likelihood of failures that might cause harm and take appropriate remedial actions. Buyer will fully indemnify TI and its representatives against any damages arising out of the use of any TI components in safety-critical applications.

In some cases, TI components may be promoted specifically to facilitate safety-related applications. With such components, TI's goal is to help enable customers to design and create their own end-product solutions that meet applicable functional safety standards and requirements. Nonetheless, such components are subject to these terms.

No TI components are authorized for use in FDA Class III (or similar life-critical medical equipment) unless authorized officers of the parties have executed a special agreement specifically governing such use.

Only those TI components which TI has specifically designated as military grade or "enhanced plastic" are designed and intended for use in military/aerospace applications or environments. Buyer acknowledges and agrees that any military or aerospace use of TI components which have **not** been so designated is solely at the Buyer's risk, and that Buyer is solely responsible for compliance with all legal and regulatory requirements in connection with such use.

TI has specifically designated certain components as meeting ISO/TS16949 requirements, mainly for automotive use. In any case of use of non-designated products, TI will not be responsible for any failure to meet ISO/TS16949.

Products

Audio	www.ti.com/audio
Amplifiers	amplifier.ti.com
Data Converters	dataconverter.ti.com
DLP® Products	www.dlp.com
DSP	dsp.ti.com
Clocks and Timers	www.ti.com/clocks
Interface	interface.ti.com
Logic	logic.ti.com
Power Mgmt	power.ti.com
Microcontrollers	microcontroller.ti.com
RFID	www.ti-rfid.com
OMAP Applications Processors	www.ti.com/omap
Wireless Connectivity	www.ti.com/wirelessconnectivity

Applications

Automotive and Transportation	www.ti.com/automotive
Communications and Telecom	www.ti.com/communications
Computers and Peripherals	www.ti.com/computers
Consumer Electronics	www.ti.com/consumer-apps
Energy and Lighting	www.ti.com/energy
Industrial	www.ti.com/industrial
Medical	www.ti.com/medical
Security	www.ti.com/security
Space, Avionics and Defense	www.ti.com/space-avionics-defense
Video and Imaging	www.ti.com/video

TI E2E Community

e2e.ti.com

Looking for pricing, stock, or lifecycle information?

Click below to explore more details on WIN SOURCE:

 [View LM4680SD/NOPB on WIN SOURCE](#)

 [Texas Instruments](#) Information

Optimize Your Supply Chain with WIN SOURCE Solutions

-  Global Sourcing Solution
-  Obsolete Management
-  Cost Control Management
-  Shortage Management
-  Alternative Solution
-  Excess Inventory Management