



**THE DATASHEET OF
LM4674SQ/NOPB**



LM4674 Boomer® Audio Power Amplifier Series **Filterless 2.5W Stereo Class D Audio Power Amplifier**

Check for Samples: [LM4674](#)

FEATURES

- Output Short Circuit Protection
- Stereo Class D Operation
- No Output Filter Required
- Logic Selectable Gain
- Independent Shutdown Control
- Minimum External Components
- Click and Pop Suppression
- Micro-Power Shutdown
- Available in Space-Saving 2mm x 2mm x 0.6mm DSBGA, and 4mm x 4mm x 0.8mm WQFN Packages

APPLICATIONS

- Mobile Phones
- PDAs
- Laptops

KEY SPECIFICATIONS

- Efficiency at 3.6V, 100mW into 8Ω: 80% (typ)
- Efficiency at 3.6V, 500mW into 8Ω: 85% (typ)
- Efficiency at 5V, 1W into 8Ω: 85% (typ)
- Quiescent Power Supply Current at 3.6V supply: 4mA
- Power Output at $V_{DD} = 5V$, $R_L = 4\Omega$, THD $\leq 10\%$: 2.5 W (typ)
- Shutdown Current: 0.03μA (typ)

DESCRIPTION

The LM4674 is a single supply, high efficiency, 2.5W/channel, filterless switching audio amplifier. A low noise PWM architecture eliminates the output filter, reducing external component count, board area consumption, system cost, and simplifying design.

The LM4674 is designed to meet the demands of mobile phones and other portable communication devices. Operating from a single 5V supply, the device is capable of delivering 2.5W/channel of continuous output power to a 4Ω load with less than 10% THD+N. Flexible power supply requirements allow operation from 2.4V to 5.5V.

The LM4674 features high efficiency compared to conventional Class AB amplifiers. When driving an 8Ω speaker from a 3.6V supply, the device features 85% efficiency at $P_O = 500mW$. Four gain options are pin selectable through the G0 and G1 pins.

Output short circuit protection prevents the device from being damaged during fault conditions. Superior click and pop suppression eliminates audible transients on power-up/down and during shutdown. Independent left/right shutdown control maximizes power savings in mixed mono/stereo applications.



Please be aware that an important notice concerning availability, standard warranty, and use in critical applications of Texas Instruments semiconductor products and disclaimers thereto appears at the end of this data sheet.

All trademarks are the property of their respective owners.

TYPICAL APPLICATION

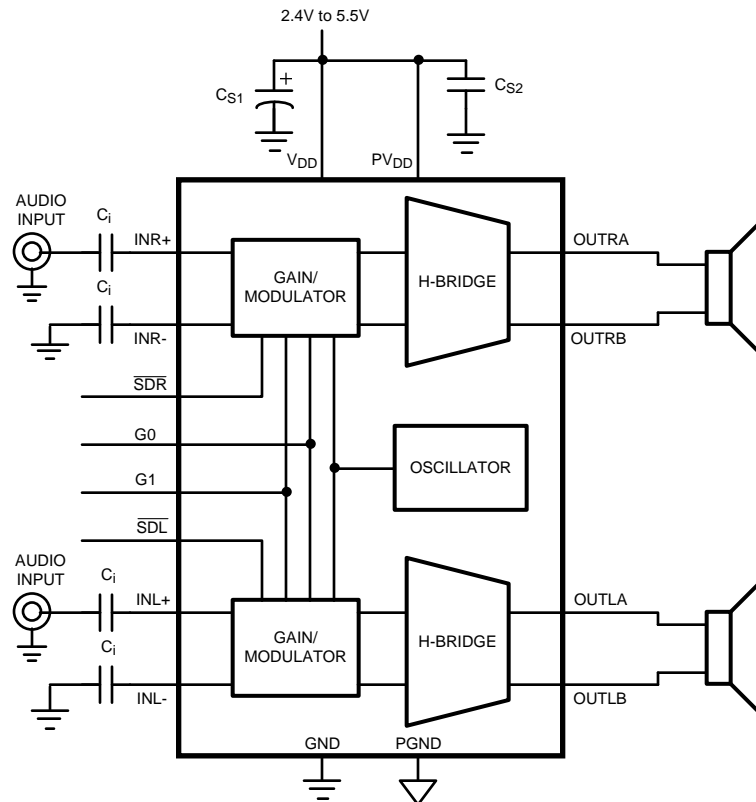

$C_i = 1 \mu\text{F}$
 $C_{S1} = 1 \mu\text{F}$
 $C_{S2} = 0.1 \mu\text{F}$

Figure 1. Typical Audio Amplifier Application Circuit

EXTERNAL COMPONENTS DESCRIPTION

(Figure 1)

Components		Functional Description
1.	C_S	Supply bypass capacitor which provides power supply filtering. Refer to the AUDIO AMPLIFIER INPUT CAPACITOR SELECTION section for information concerning proper placement and selection of the supply bypass capacitor.
2.	C_i	Input AC coupling capacitor which blocks the DC voltage at the amplifier's input terminals.

CONNECTION DIAGRAM

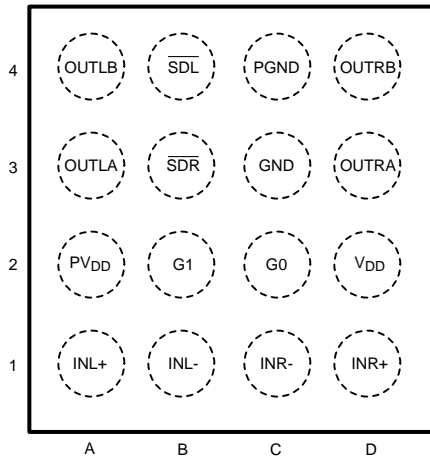

Figure 2. DSBGA (Top View)
See YZR0016 Package

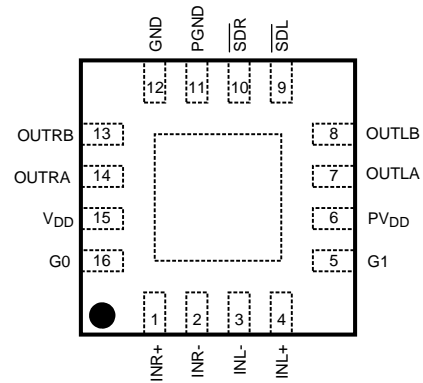

Figure 3. WQFN (Top View)
See RGH0016A Package

PIN DESCRIPTION

BUMP	PIN	NAME	FUNCTION
A1	4	INL+	Non-inverting left channel input
A2	6	PV _{DD}	Power V _{DD}
A3	7	OUTLA	Left channel output A
A4	8	OUTLB	Left channel output B
B1	3	INL-	Inverting left channel input
B2	5	G1	Gain setting input 1
B3	10	$\overline{\text{SDR}}$	Right channel shutdown input
B4	9	$\overline{\text{SDL}}$	Left channel shutdown input
C1	2	INR-	Inverting right channel input
C2	16	G0	Gain setting input 0
C3	12	GND	Ground
C4	11	PGND	Power Ground
D1	1	INR+	Non-inverting right channel input
D2	15	V _{DD}	Power Supply
D3	14	OUTRA	Right channel output A
D4	13	OUTRB	Right channel output B



These devices have limited built-in ESD protection. The leads should be shorted together or the device placed in conductive foam during storage or handling to prevent electrostatic damage to the MOS gates.

ABSOLUTE MAXIMUM RATINGS⁽¹⁾⁽²⁾

Supply Voltage ⁽¹⁾		6.0V
Storage Temperature		-65°C to +150°C
Input Voltage		-0.3V to V _{DD} + 0.3V
Power Dissipation ⁽³⁾		Internally Limited
ESD Susceptibility, all other pins ⁽⁴⁾		2000V
ESD Susceptibility ⁽⁵⁾		200V
Junction Temperature (T _{JMAX})		150°C
Thermal Resistance	θ _{JA} (DSBGA)	45.7°C/W
	θ _{JA} (WQFN)	38.9°C/W

- (1) All voltages are measured with respect to the ground pin, unless otherwise specified.
- (2) Absolute Maximum Ratings indicate limits beyond which damage to the device may occur. Operating Ratings indicate conditions for which the device is functional, but do not ensure specific performance limits. Electrical Characteristics state DC and AC electrical specifications under particular test conditions which ensure specific performance limits. This assumes that the device is within the Operating Ratings. Specifications are not ensured for parameters where no limit is given, however, the typical value is a good indication of device performance.
- (3) The maximum power dissipation must be derated at elevated temperatures and is dictated by T_{JMAX}, θ_{JA}, and the ambient temperature, T_A. The maximum allowable power dissipation is P_{DMAX} = (T_{JMAX} - T_A) / θ_{JA} or the number given in Absolute Maximum Ratings, whichever is lower. For the LM4674 see power derating currents for more information.
- (4) Human body model, 100pF discharged through a 1.5kΩ resistor.
- (5) Machine Model, 220pF–240pF discharged through all pins.

OPERATING RATINGS⁽¹⁾⁽²⁾

Temperature Range (T _{MIN} ≤ T _A ≤ T _{MAX})	-40°C ≤ T _A ≤ 85°C
Supply Voltage	2.4V ≤ V _{DD} ≤ 5.5V

- (1) All voltages are measured with respect to the ground pin, unless otherwise specified.
- (2) Absolute Maximum Ratings indicate limits beyond which damage to the device may occur. Operating Ratings indicate conditions for which the device is functional, but do not ensure specific performance limits. Electrical Characteristics state DC and AC electrical specifications under particular test conditions which ensure specific performance limits. This assumes that the device is within the Operating Ratings. Specifications are not ensured for parameters where no limit is given, however, the typical value is a good indication of device performance.

ELECTRICAL CHARACTERISTICS V_{DD} = 3.6V⁽¹⁾⁽²⁾

The following specifications apply for A_v = 6dB, R_L = 15μH + 8Ω + 15μH, f = 1kHz unless otherwise specified. Limits apply for T_A = 25°C.

Symbol	Parameter	Conditions	LM4674		Units (Limits)
			Typical ⁽³⁾	Limit ⁽⁴⁾⁽⁵⁾	
V _{OS}	Differential Output Offset Voltage	V _{IN} = 0, V _{DD} = 2.4V to 5.0V	5		mV
I _{DD}	Quiescent Power Supply Current	V _{IN} = 0, R _L = ∞, Both channels active, V _{DD} = 3.6V	4	6	mA
		V _{IN} = 0, R _L = ∞, Both channels active, V _{DD} = 5V	5	7.5	mA
I _{SD}	Shutdown Current	V _{SDR} = V _{SDL} = GND	0.03	1	μA
V _{SDIH}	Shutdown Voltage Input High			1.4	V (min)
V _{SDIL}	Shutdown Voltage Input Low			0.4	V (max)
T _{WU}	Wake Up Time	V _{SDR/SDL} = 0.4V	0.5		ms

- (1) All voltages are measured with respect to the ground pin, unless otherwise specified.
- (2) Absolute Maximum Ratings indicate limits beyond which damage to the device may occur. Operating Ratings indicate conditions for which the device is functional, but do not ensure specific performance limits. Electrical Characteristics state DC and AC electrical specifications under particular test conditions which ensure specific performance limits. This assumes that the device is within the Operating Ratings. Specifications are not ensured for parameters where no limit is given, however, the typical value is a good indication of device performance.
- (3) Typicals are measured at 25°C and represent the parametric norm.
- (4) Limits are specified to AOQL (Average Outgoing Quality Level).
- (5) Datasheet min/max specification limits are specified by design, test, or statistical analysis.

ELECTRICAL CHARACTERISTICS $V_{DD} = 3.6V^{(1)(2)}$ (continued)

The following specifications apply for $A_V = 6dB$, $R_L = 15\mu H + 8\Omega + 15\mu H$, $f = 1kHz$ unless otherwise specified. Limits apply for $T_A = 25^\circ C$.

Symbol	Parameter	Conditions	LM4674		Units (Limits)
			Typical ⁽³⁾	Limit ⁽⁴⁾⁽⁵⁾	
A_V	Gain	$G_0, G_1 = GND$ $R_L = \infty$	6	6 ± 0.5	dB
		$G_0 = V_{DD}, G_1 = GND$ $R_L = \infty$	12	12 ± 0.5	dB
		$G_0 = GND, G_1 = V_{DD}$ $R_L = \infty$	18	18 ± 0.5	dB
		$G_0, G_1 = V_{DD}$ $R_L = \infty$	24	24 ± 0.5	dB
R_{IN}	Input Resistance	$A_V = 6dB$	28		k Ω
		$A_V = 12dB$	18.75		k Ω
		$A_V = 18dB$	11.25		k Ω
		$A_V = 24dB$	6.25		k Ω
P_O	Output Power	$R_L = 15\mu H + 4\Omega + 15\mu H$, THD $\leq 10\%$ $f = 1kHz$, 22kHz BW			
		$V_{DD} = 5V$	2.5		W
		$V_{DD} = 3.6V$	1.2		W
		$V_{DD} = 2.5V$	0.530		W
		$R_L = 15\mu H + 8\Omega + 15\mu H$, THD $\leq 10\%$ $f = 1kHz$, 22kHz BW			
		$V_{DD} = 5V$	1.5		W
		$V_{DD} = 3.6V$	0.78	0.6	W
		$V_{DD} = 2.5V$	0.350		W
		$R_L = 15\mu H + 4\Omega + 15\mu H$, THD $\leq 1\%$ $f = 1kHz$, 22kHz BW			
		$V_{DD} = 5V$	1.9		W
		$V_{DD} = 3.6V$	1		W
		$V_{DD} = 2.5V$	0.430		W
		$R_L = 15\mu H + 8\Omega + 15\mu H$, THD = 1% $f = 1kHz$, 22kHz BW			
		$V_{DD} = 5V$	1.25		W
		$V_{DD} = 3.6V$	0.63		W
		$V_{DD} = 2.5V$	0.285		W
THD+N	Total Harmonic Distortion	$P_O = 500mW$, $f = 1kHz$, $R_L = 8\Omega$	0.07		%
		$P_O = 300mW$, $f = 1kHz$, $R_L = 8\Omega$	0.05		%
PSRR	Power Supply Rejection Ratio	$V_{RIPPLE} = 200mV_{P-P}$ Sine, $f_{RIPPLE} = 217Hz$, Inputs AC GND, $C_i = 1\mu F$, input referred	75		dB
		$V_{RIPPLE} = 1V_{P-P}$ Sine, $f_{RIPPLE} = 1kHz$, Inputs AC GND, $C_i = 1\mu F$, input referred	75		dB
CMRR	Common Mode Rejection Ratio	$V_{RIPPLE} = 1V_{P-P}$ $f_{RIPPLE} = 217Hz$	67		dB
η	Efficiency	$P_O = 1W$, $f = 1kHz$, $R_L = 8\Omega$, $V_{DD} = 5V$	85		%
Xtalk	Crosstalk	$P_O = 500mW$, $f = 1kHz$	84		dB
SNR	Signal to Noise Ratio	$V_{DD} = 5V$, $P_O = 1W$	96		dB
ϵ_{OS}	Output Noise	Input referred, A-Weighted Filter	20		μV

BLOCK DIAGRAMS

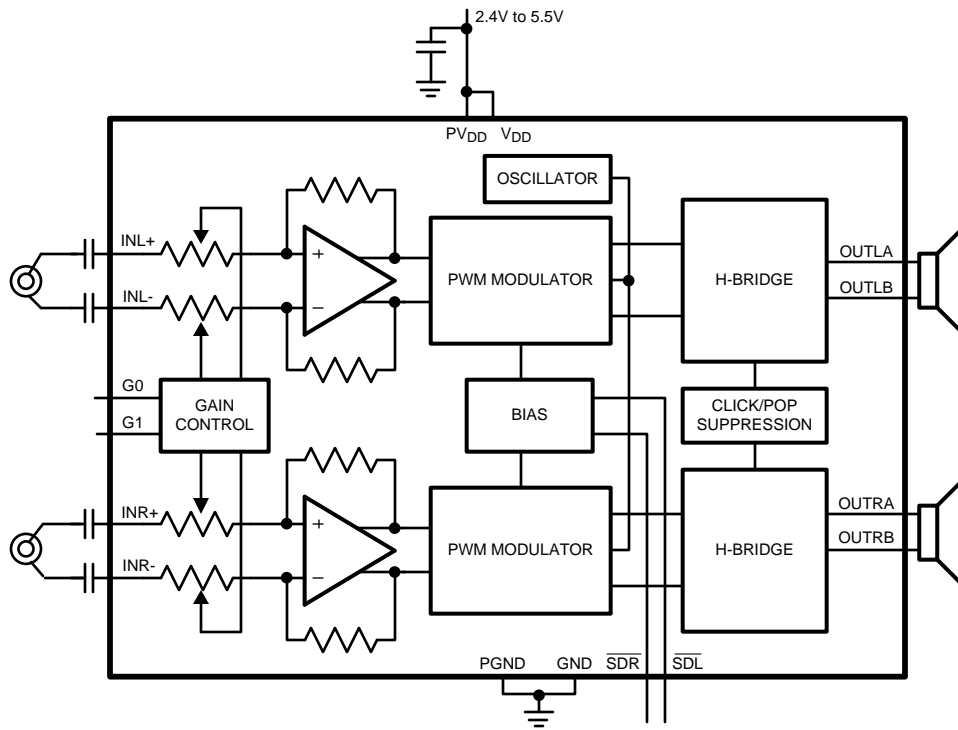

Figure 4. Differential Input Configuration

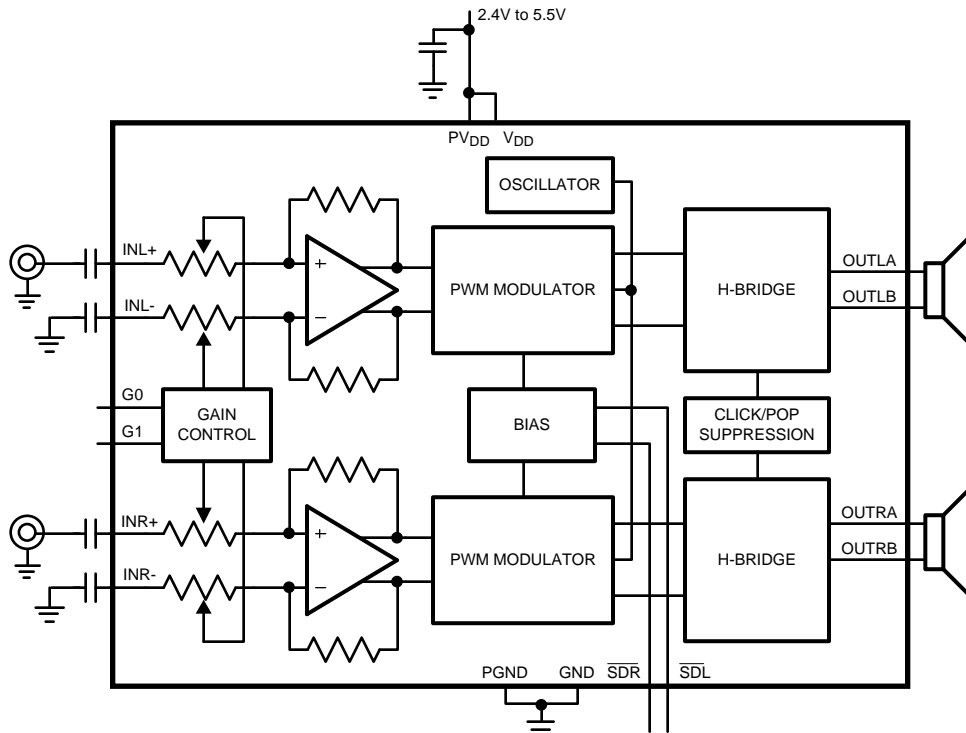

Figure 5. Single-Ended Input Configuration

TYPICAL PERFORMANCE CHARACTERISTICS

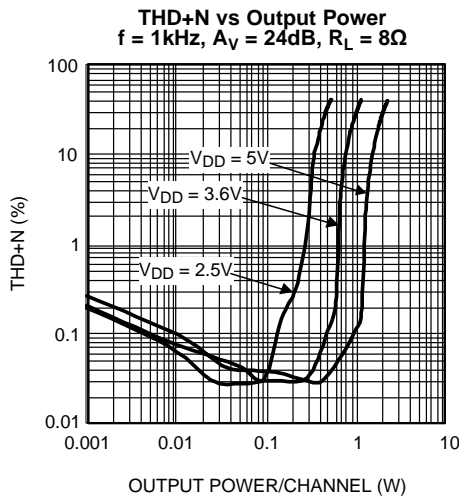

Figure 6.

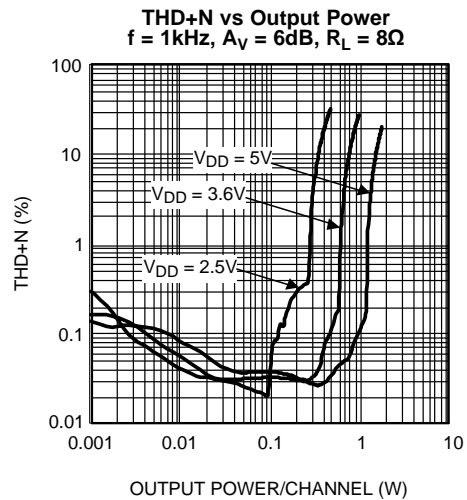

Figure 7.

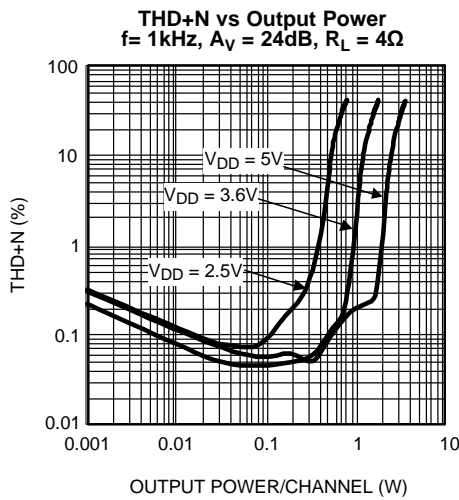

Figure 8.

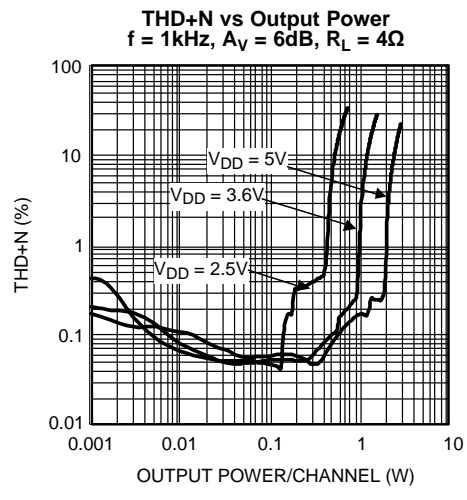

Figure 9.

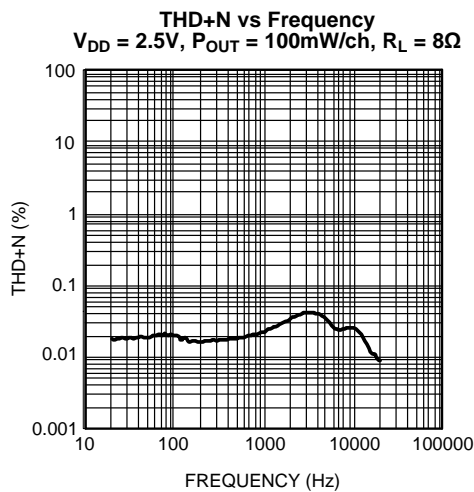

Figure 10.

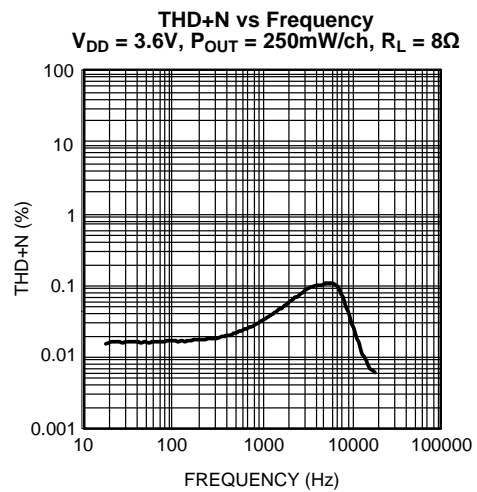

Figure 11.

TYPICAL PERFORMANCE CHARACTERISTICS (continued)

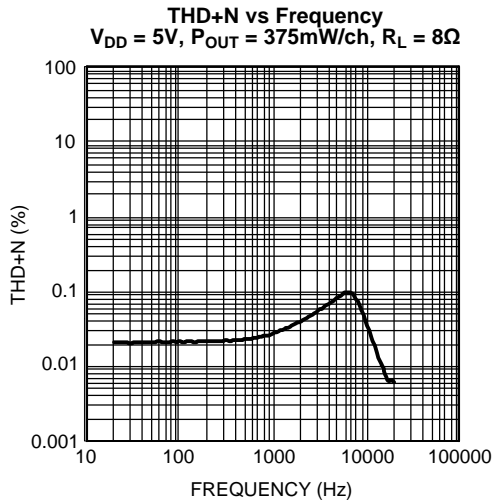

Figure 12.

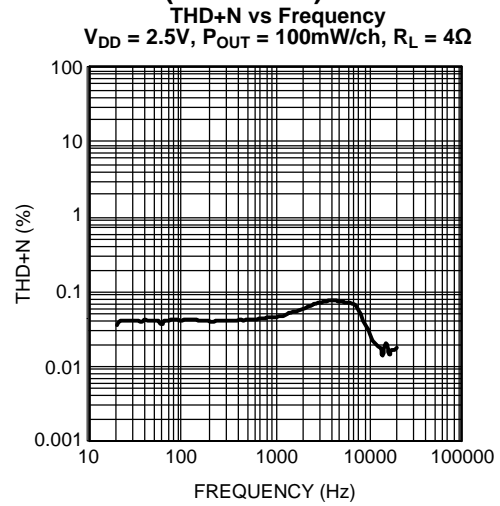

Figure 13.

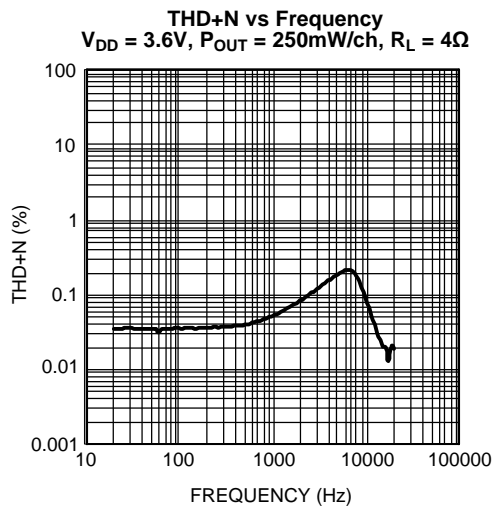

Figure 14.

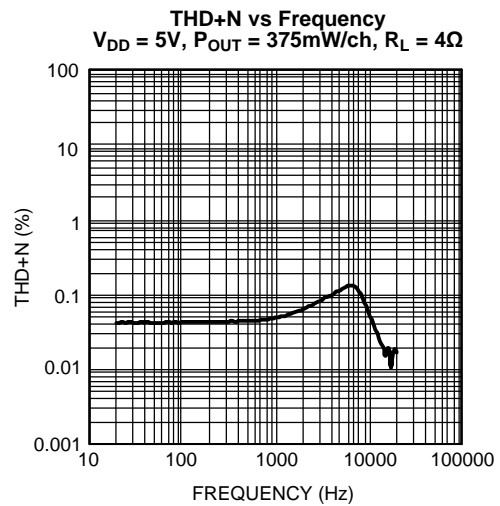

Figure 15.

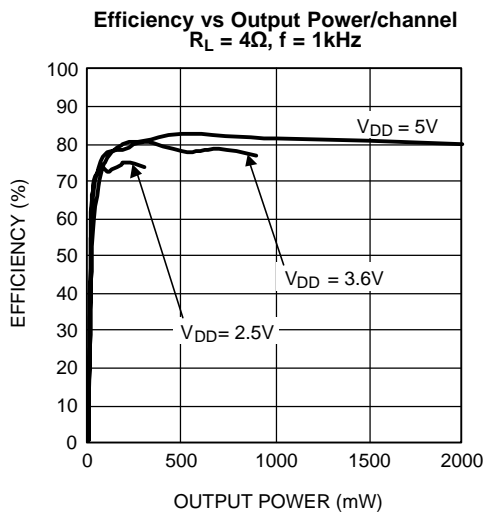

Figure 16.

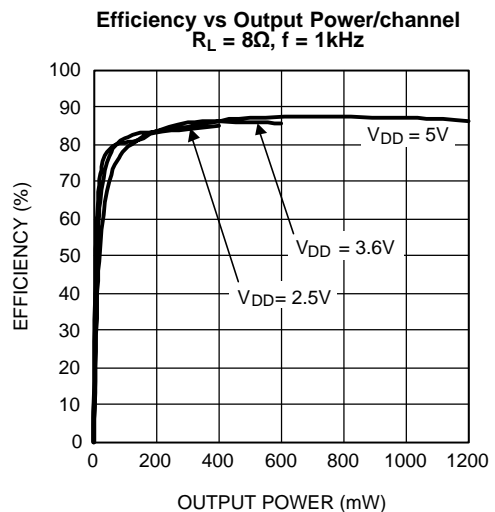

Figure 17.

TYPICAL PERFORMANCE CHARACTERISTICS (continued)

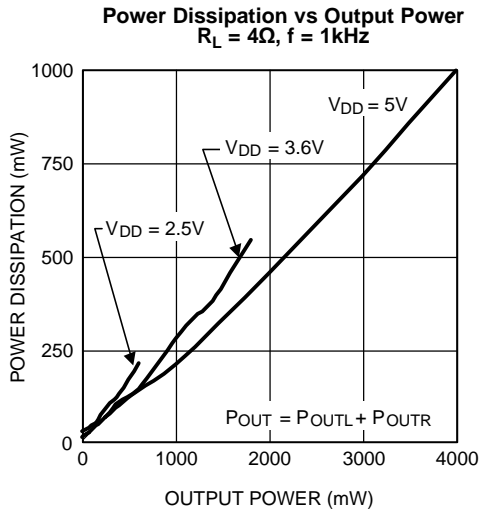

Figure 18.

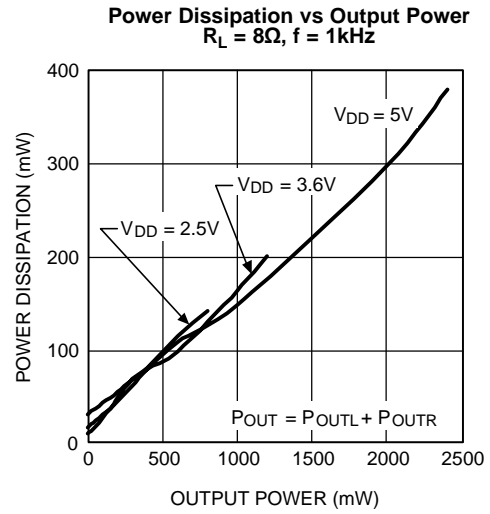

Figure 19.

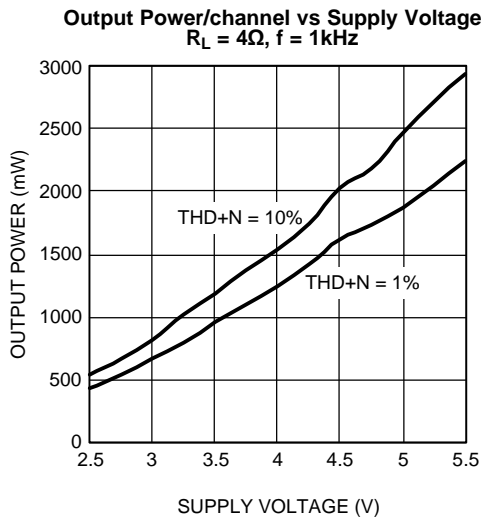

Figure 20.

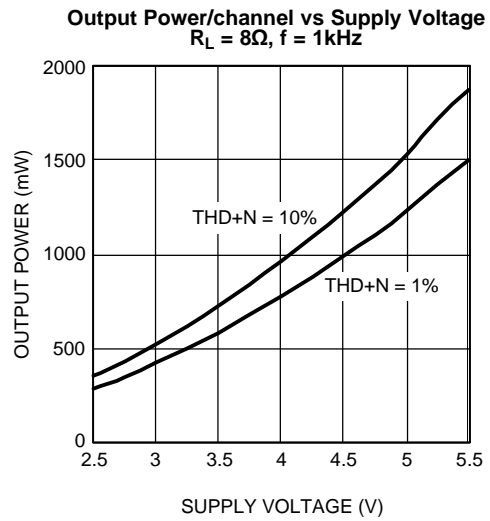

Figure 21.

TYPICAL PERFORMANCE CHARACTERISTICS (continued)

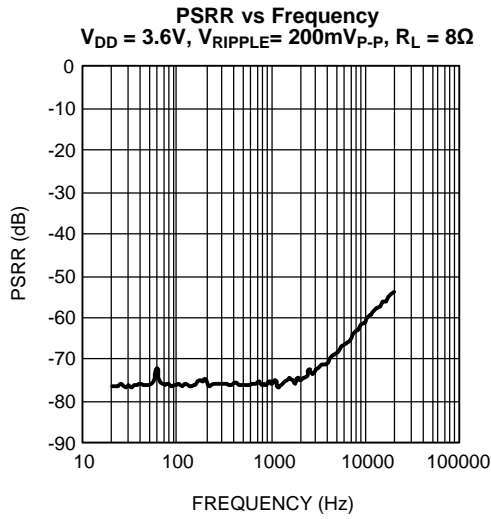

Figure 22.

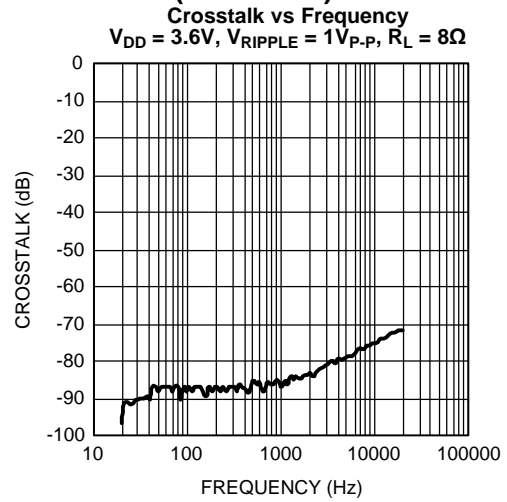

Figure 23.

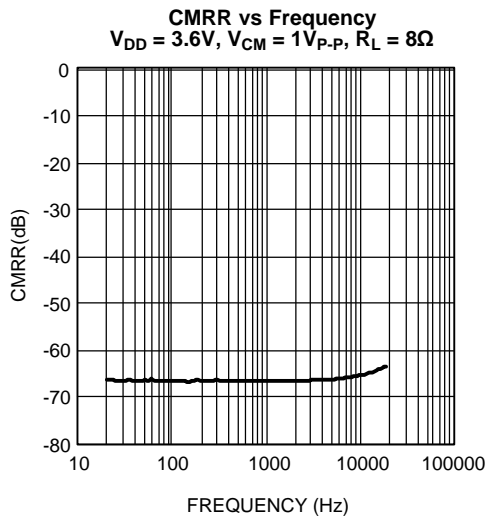

Figure 24.

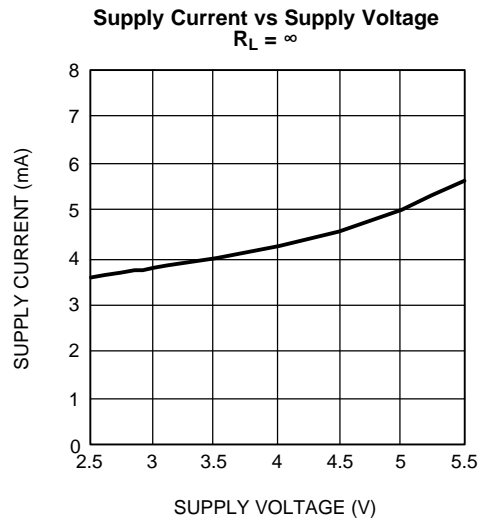

Figure 25.

APPLICATION INFORMATION

GENERAL AMPLIFIER FUNCTION

The LM4674 stereo Class D audio power amplifier features a filterless modulation scheme that reduces external component count, conserving board space and reducing system cost. The outputs of the device transition from V_{DD} to GND with a 300kHz switching frequency. With no signal applied, the outputs for each channel switch with a 50% duty cycle, in phase, causing the two outputs to cancel. This cancellation results in no net voltage across the speaker, thus there is no current to the load in the idle state.

With the input signal applied, the duty cycle (pulse width) of the LM4674 outputs changes. For increasing output voltage, the duty cycle of the A output increases, while the duty cycle of the B output decreases for each channel. For decreasing output voltages, the converse occurs. The difference between the two pulse widths yields the differential output voltage.

DIFFERENTIAL AMPLIFIER EXPLANATION

As logic supplies continue to shrink, system designers are increasingly turning to differential analog signal handling to preserve signal to noise ratios with restricted voltage signs. The LM4674 features two fully differential amplifiers. A differential amplifier amplifies the difference between the two input signals. Traditional audio power amplifiers have typically offered only single-ended inputs resulting in a 6dB reduction of SNR relative to differential inputs. The LM4674 also offers the possibility of DC input coupling which eliminates the input coupling capacitors. A major benefit of the fully differential amplifier is the improved common mode rejection ratio (CMRR) over single ended input amplifiers. The increased CMRR of the differential amplifier reduces sensitivity to ground offset related noise injection, especially important in noisy systems.

POWER DISSIPATION AND EFFICIENCY

The major benefit of a Class D amplifier is increased efficiency versus a class AB amplifier. The efficiency of the LM4674 is attributed to the region of operation of the transistors in the output stage. The Class D output stage acts as current steering switches, consuming negligible amounts of power compared to their Class AB counterparts. Most of the power loss associated with the output stage is due to the IR loss of the MOSFET on-resistance ($R_{DS(ON)}$), along with switching losses due to gate charge.

SHUTDOWN FUNCTION

The LM4674 features independent left and right channel shutdown controls, allowing each channel to be disabled independently. \overline{SDR} controls the right channel, while \overline{SDL} controls the left channel. Driving either low disables the corresponding channel.

It is best to switch between ground and V_{DD} for minimum current consumption while in shutdown. The LM4674 may be disabled with shutdown voltages in between GND and V_{DD} , the idle current will be greater than the typical 0.03 μ A value. For logic levels between GND and V_{DD} bypass \overline{SD}_- with a 0.1 μ F capacitor.

The LM4674 shutdown inputs have internal pulldown resistors. The purpose of these resistors is to eliminate any unwanted state changes when \overline{SD}_- is floating. To minimize shutdown current, \overline{SD}_- should be driven to GND or left floating. If \overline{SD}_- is not driven to GND or floating, an increase in shutdown supply current will be noticed.

SINGLE-ENDED AUDIO AMPLIFIER CONFIGURATION

The LM4674 is compatible with single-ended sources. When configured for single-ended inputs, input capacitors must be used to block any DC component at the input of the device. Figure 5 shows the typical single-ended applications circuit.

AUDIO AMPLIFIER POWER SUPPLY BYPASSING/FILTERING

Proper power supply bypassing is critical for low noise performance and high PSRR. Place the supply bypass capacitor as close to the device as possible. Typical applications employ a voltage regulator with 10 μ F and 0.1 μ F bypass capacitors that increase supply stability. These capacitors do not eliminate the need for bypassing of the LM4674 supply pins. A 1 μ F capacitor is recommended.

AUDIO AMPLIFIER INPUT CAPACITOR SELECTION

Input capacitors may be required for some applications, or when the audio source is single-ended. Input capacitors block the DC component of the audio signal, eliminating any conflict between the DC component of the audio source and the bias voltage of the LM4674. The input capacitors create a high-pass filter with the input resistance R_i . The -3dB point of the high pass filter is found using [Equation \(1\)](#) below.

$$f = 1 / 2\pi R_i C_i \quad (1)$$

The values for R_i can be found in the EC table for each gain setting.

The input capacitors can also be used to remove low frequency content from the audio signal. Small speakers cannot reproduce, and may even be damaged by low frequencies. High pass filtering the audio signal helps protect the speakers. When the LM4674 is using a single-ended source, power supply noise on the ground is seen as an input signal. Setting the high-pass filter point above the power supply noise frequencies, 217 Hz in a GSM phone, for example, filters out the noise such that it is not amplified and heard on the output. Capacitors with a tolerance of 10% or better are recommended for impedance matching and improved CMRR and PSRR.

AUDIO AMPLIFIER GAIN SETTING

The LM4674 features four internally configured gain settings. The device gain is selected through the two logic inputs, G0 and G1. The gain settings are as shown in the following table.

LOGIC INPUT		GAIN	
G1	G0	V/V	dB
0	0	2	6
0	1	4	12
1	0	8	18
1	1	16	24

PCB LAYOUT GUIDELINES

As output power increases, interconnect resistance (PCB traces and wires) between the amplifier, load and power supply create a voltage drop. The voltage loss due to the traces between the LM4674 and the load results in lower output power and decreased efficiency. Higher trace resistance between the supply and the LM4674 has the same effect as a poorly regulated supply, increasing ripple on the supply line, and reducing peak output power. The effects of residual trace resistance increases as output current increases due to higher output power, decreased load impedance or both. To maintain the highest output voltage swing and corresponding peak output power, the PCB traces that connect the output pins to the load and the supply pins to the power supply should be as wide as possible to minimize trace resistance.

The use of power and ground planes will give the best THD+N performance. In addition to reducing trace resistance, the use of power planes creates parasitic capacitors that help to filter the power supply line.

The inductive nature of the transducer load can also result in overshoot on one or both edges, clamped by the parasitic diodes to GND and VDD in each case. From an EMI standpoint, this is an aggressive waveform that can radiate or conduct to other components in the system and cause interference. It is essential to keep the power and output traces short and well shielded if possible. Use of ground planes beads and micro-strip layout techniques are all useful in preventing unwanted interference.

As the distance from the LM4674 and the speaker increases, the amount of EMI radiation increases due to the output wires or traces acting as antennas become more efficient with length. Ferrite chip inductors placed close to the LM4674 outputs may be needed to reduce EMI radiation.

LM4674TL DEMO BOARD SCHEMATIC

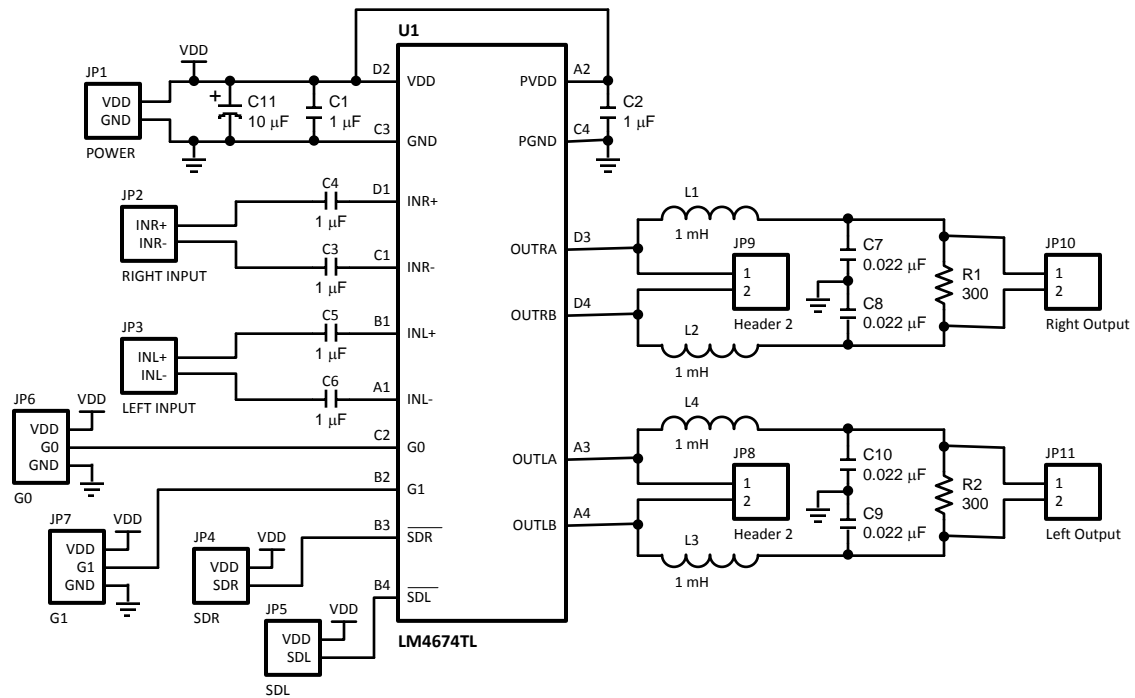

Figure 26. LM4674TL Demo Board Schematic

LM4674TL DEMONSTRATION BOARD LAYOUT

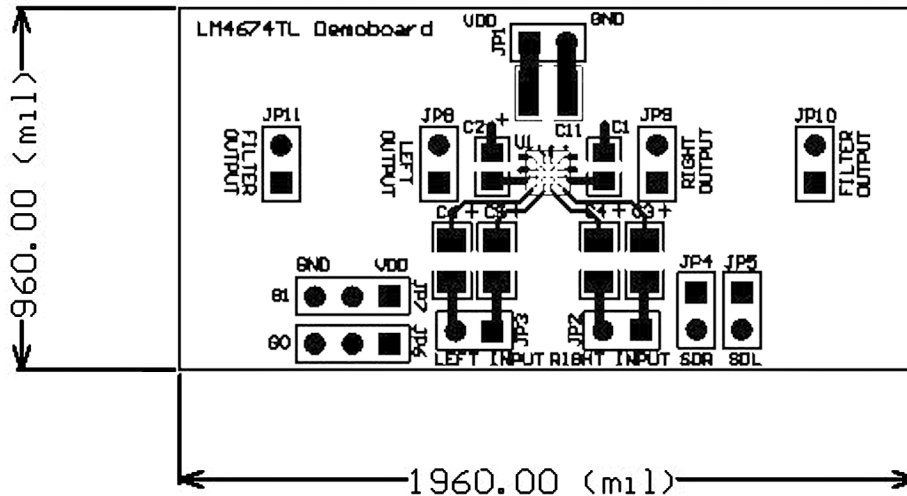

Figure 27. Layer 1

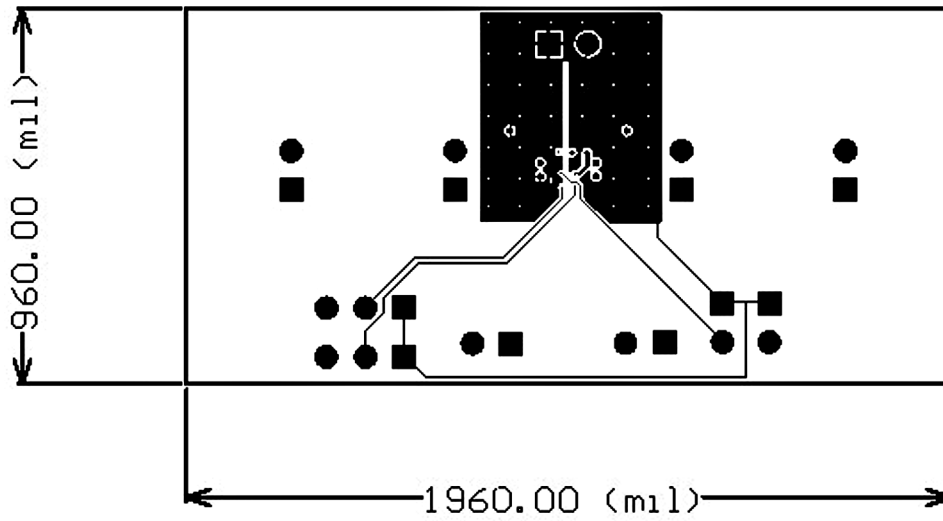

Figure 28. Layer 2

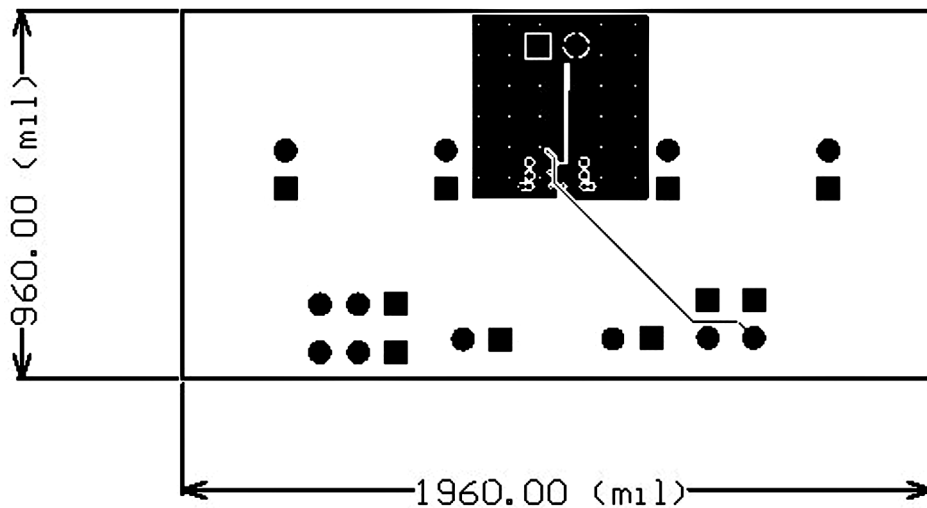

Figure 29. Layer 3

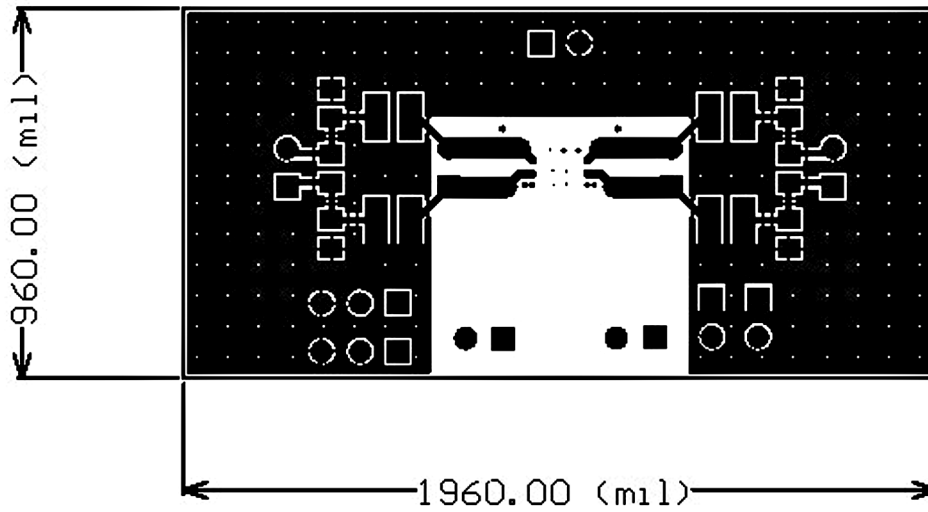

Figure 30. Layer 4

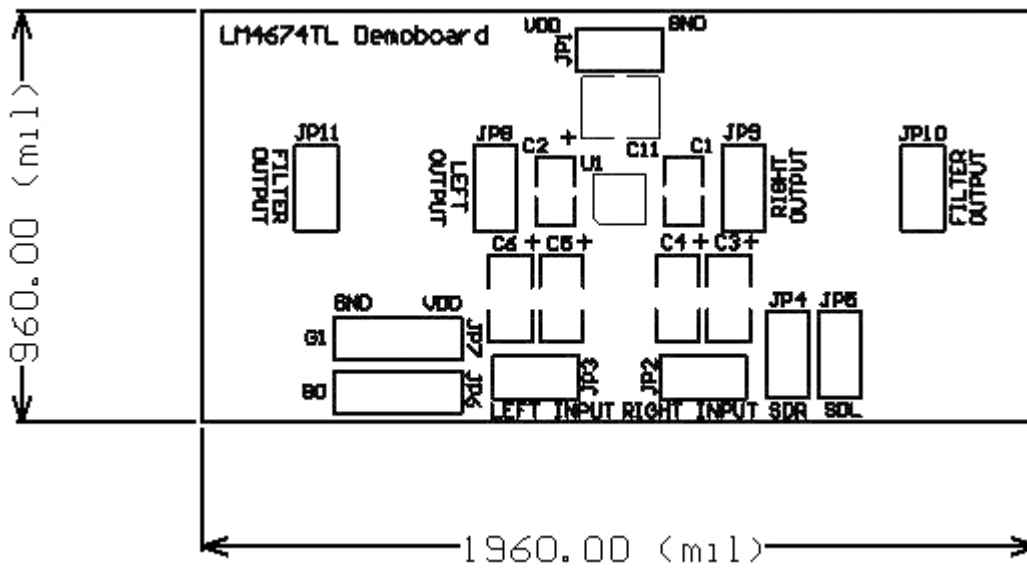

Figure 31. Top Silkscreen

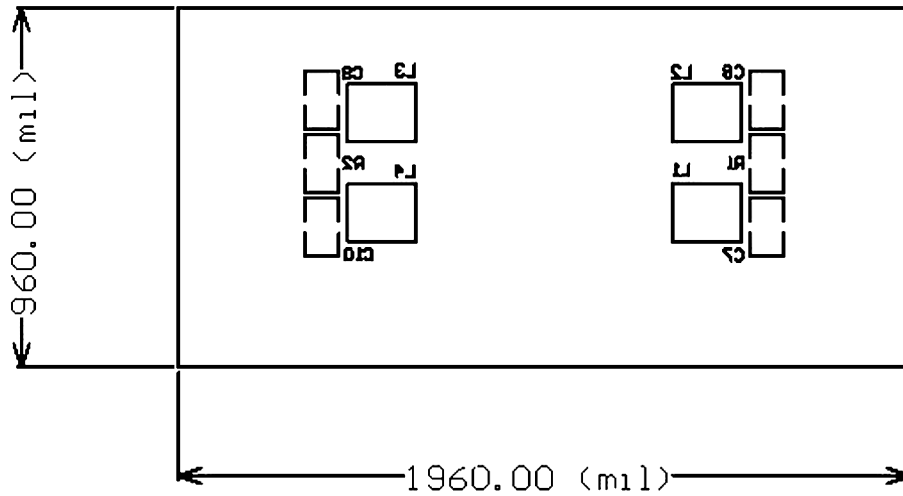

Figure 32. Bottom Silkscreen

LM4674SQ DEMO BOARD SCHEMATIC

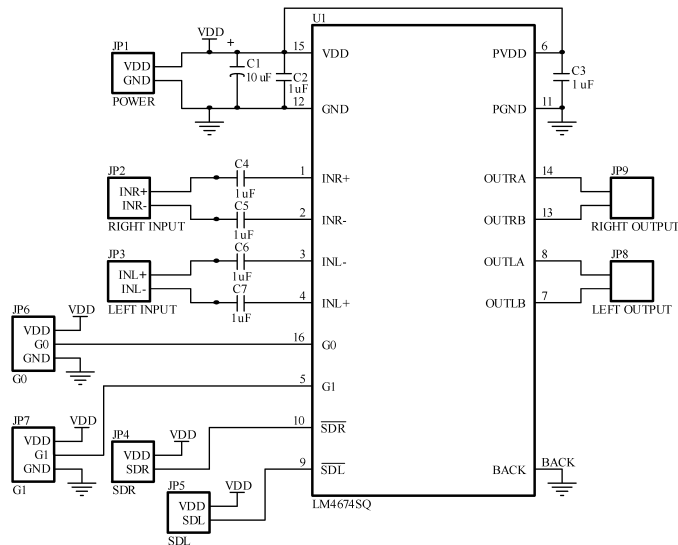

Figure 33. LM4674SQ Demo Board Schematic

LM4674SQ DEMONSTRATION BOARD LAYOUT

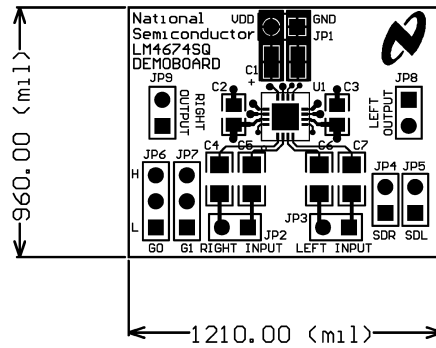

Figure 34. Layer 1

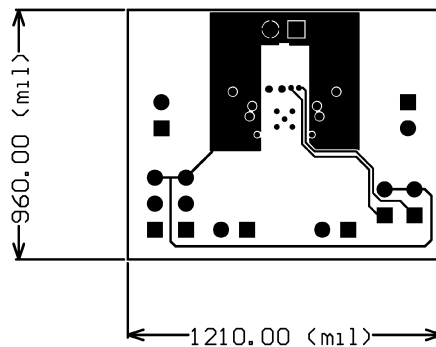

Figure 35. Layer 2

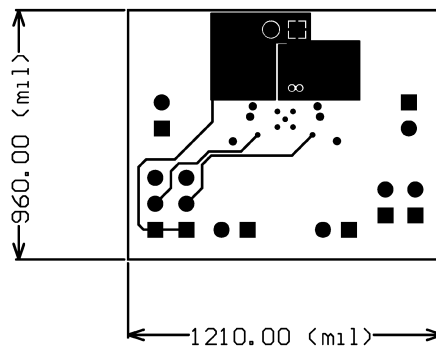

Figure 36. Layer 3

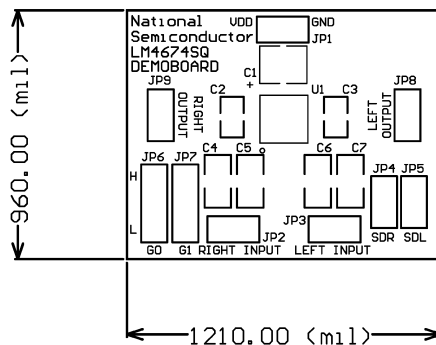

Figure 37. Top Silkscreen

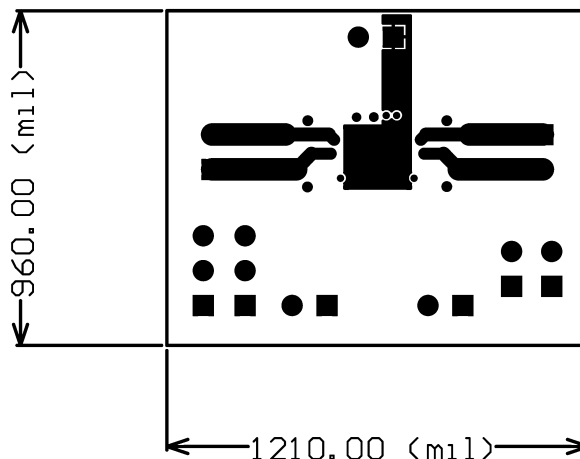

Figure 38. Bottom Layer

REVISION TABLE

Rev	Date	Description
1.0	12/16/06	Initial release.
1.1	05/17/06	Added the LLP package.
1.2	05/31/06	Added the LLP markings.
1.3	09/05/06	Added "No Load" in the Conditions on Av (3.6V table).
1.4	09/21/06	Edited graphics (26, 38, 60) and input some text edits.
1.5	09/27/06	Edited Figure 1 (page 2), TL and LLP pkg/marking drawings (page 3). Input text edits.
1.6	07/13/07	Added the TL and SQ demo boards and schematics diagrams.
1.7	10/30/07	Updated the SQ schematic diagram and replaced the demo boards.
1.8	07/02/08	Text edits (under SHUTDOWN FUNCTION).
E	04/05/13	Changed layout of National Data Sheet to TI format.

PACKAGING INFORMATION

Orderable Device	Status (1)	Package Type	Package Drawing	Pins	Package Qty	Eco Plan (2)	Lead/Ball Finish	MSL Peak Temp (3)	Op Temp (°C)	Device Marking (4/5)	Samples
LM4674SQ/NOPB	ACTIVE	WQFN	RGH	16	1000	Green (RoHS & no Sb/Br)	CU SN	Level-1-260C-UNLIM	-40 to 85	L4674SQ	Samples
LM4674TLX/NOPB	ACTIVE	DSBGA	YZR	16	3000	Green (RoHS & no Sb/Br)	SNAGCU	Level-1-260C-UNLIM	-40 to 85	GG2	Samples

(1) The marketing status values are defined as follows:

ACTIVE: Product device recommended for new designs.

LIFEBUY: TI has announced that the device will be discontinued, and a lifetime-buy period is in effect.

NRND: Not recommended for new designs. Device is in production to support existing customers, but TI does not recommend using this part in a new design.

PREVIEW: Device has been announced but is not in production. Samples may or may not be available.

OBSELETE: TI has discontinued the production of the device.

(2) Eco Plan - The planned eco-friendly classification: Pb-Free (RoHS), Pb-Free (RoHS Exempt), or Green (RoHS & no Sb/Br) - please check <http://www.ti.com/productcontent> for the latest availability information and additional product content details.

TBD: The Pb-Free/Green conversion plan has not been defined.

Pb-Free (RoHS): TI's terms "Lead-Free" or "Pb-Free" mean semiconductor products that are compatible with the current RoHS requirements for all 6 substances, including the requirement that lead not exceed 0.1% by weight in homogeneous materials. Where designed to be soldered at high temperatures, TI Pb-Free products are suitable for use in specified lead-free processes.

Pb-Free (RoHS Exempt): This component has a RoHS exemption for either 1) lead-based flip-chip solder bumps used between the die and package, or 2) lead-based die adhesive used between the die and leadframe. The component is otherwise considered Pb-Free (RoHS compatible) as defined above.

Green (RoHS & no Sb/Br): TI defines "Green" to mean Pb-Free (RoHS compatible), and free of Bromine (Br) and Antimony (Sb) based flame retardants (Br or Sb do not exceed 0.1% by weight in homogeneous material)

(3) MSL, Peak Temp. -- The Moisture Sensitivity Level rating according to the JEDEC industry standard classifications, and peak solder temperature.

(4) There may be additional marking, which relates to the logo, the lot trace code information, or the environmental category on the device.

(5) Multiple Device Markings will be inside parentheses. Only one Device Marking contained in parentheses and separated by a "~" will appear on a device. If a line is indented then it is a continuation of the previous line and the two combined represent the entire Device Marking for that device.

Important Information and Disclaimer:The information provided on this page represents TI's knowledge and belief as of the date that it is provided. TI bases its knowledge and belief on information provided by third parties, and makes no representation or warranty as to the accuracy of such information. Efforts are underway to better integrate information from third parties. TI has taken and continues to take reasonable steps to provide representative and accurate information but may not have conducted destructive testing or chemical analysis on incoming materials and chemicals. TI and TI suppliers consider certain information to be proprietary, and thus CAS numbers and other limited information may not be available for release.

In no event shall TI's liability arising out of such information exceed the total purchase price of the TI part(s) at issue in this document sold by TI to Customer on an annual basis.

TAPE AND REEL INFORMATION

QUADRANT ASSIGNMENTS FOR PIN 1 ORIENTATION IN TAPE

*All dimensions are nominal

Device	Package Type	Package Drawing	Pins	SPQ	Reel Diameter (mm)	Reel Width W1 (mm)	A0 (mm)	B0 (mm)	K0 (mm)	P1 (mm)	W (mm)	Pin1 Quadrant
LM4674SQ/NOPB	WQFN	RGH	16	1000	178.0	12.4	4.3	4.3	1.3	8.0	12.0	Q1
LM4674TLX/NOPB	DSBGA	YZR	16	3000	178.0	8.4	2.08	2.08	0.76	4.0	8.0	Q1

TAPE AND REEL BOX DIMENSIONS

*All dimensions are nominal

Device	Package Type	Package Drawing	Pins	SPQ	Length (mm)	Width (mm)	Height (mm)
LM4674SQ/NOPB	WQFN	RGH	16	1000	210.0	185.0	35.0
LM4674TLX/NOPB	DSBGA	YZR	16	3000	210.0	185.0	35.0

YZR0016

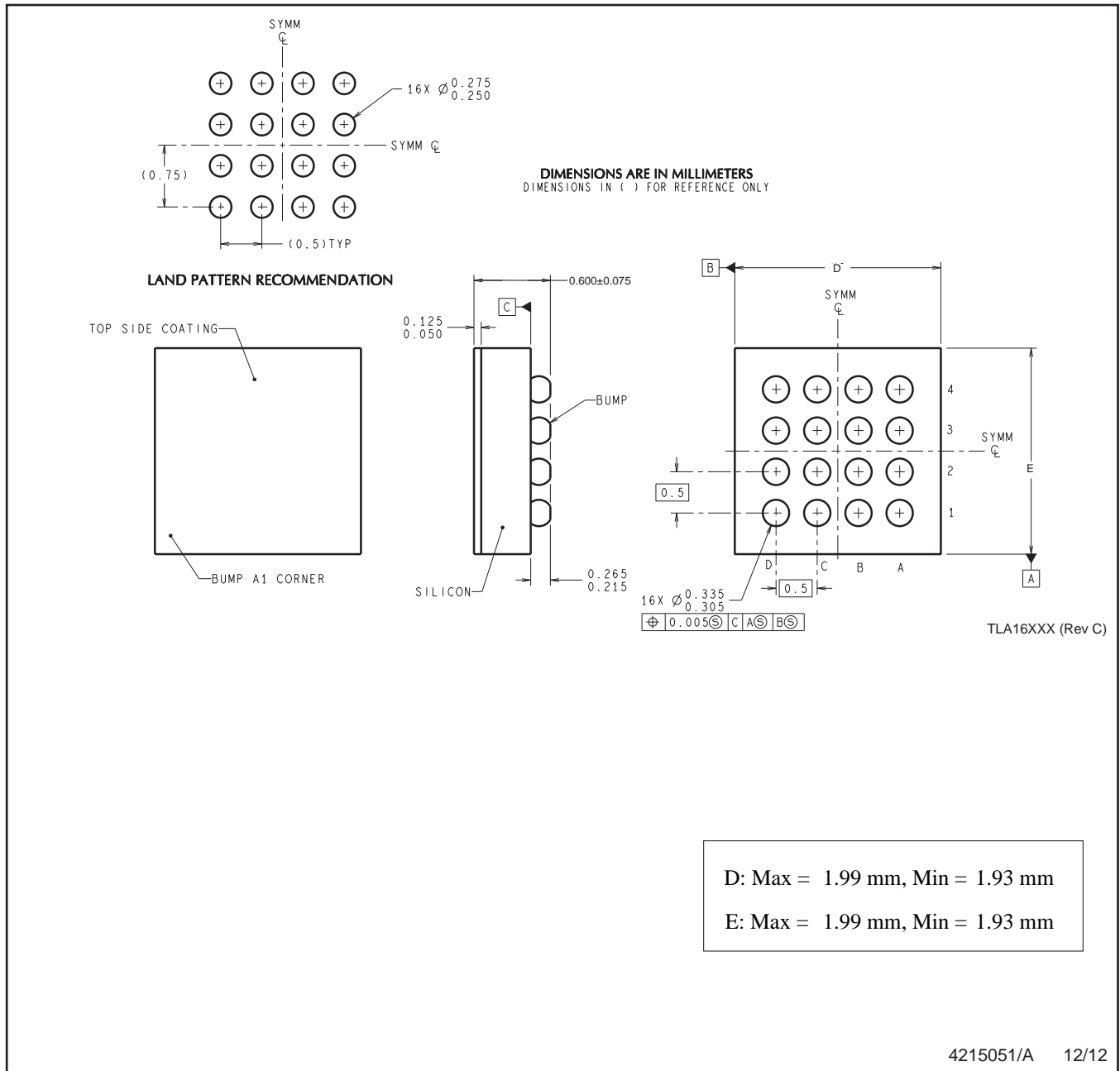

NOTES: A. All linear dimensions are in millimeters. Dimensioning and tolerancing per ASME Y14.5M-1994.
B. This drawing is subject to change without notice.

4215051/A 12/12

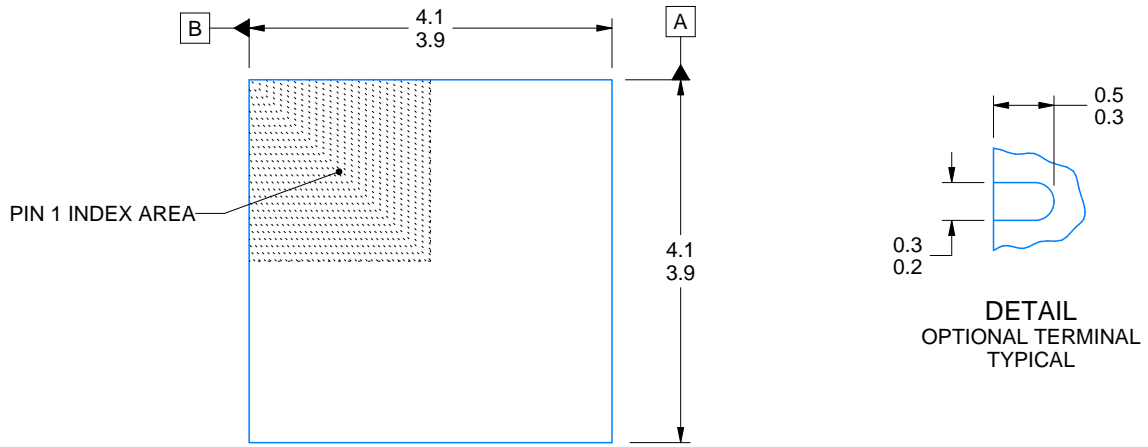
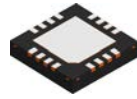

DIM A	
OPT 1	OPT 1
(0.1)	(0.2)

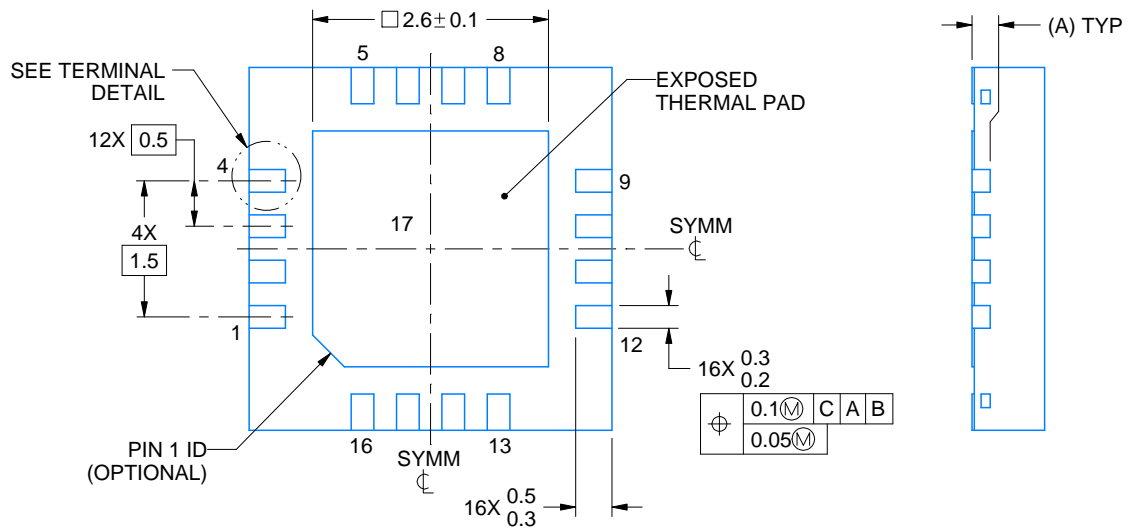
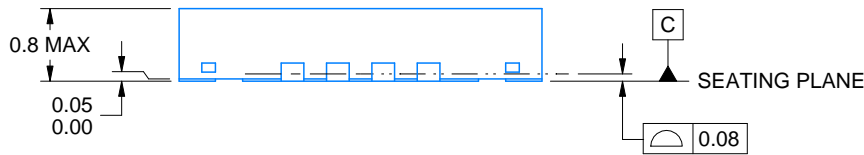

4214978/B 01/2017

NOTES:

1. All linear dimensions are in millimeters. Any dimensions in parenthesis are for reference only. Dimensioning and tolerancing per ASME Y14.5M.
2. This drawing is subject to change without notice.
3. The package thermal pad must be soldered to the printed circuit board for optimal thermal and mechanical performance.

EXAMPLE BOARD LAYOUT

RGH0016A

WQFN - 0.8 mm max height

PLASTIC QUAD FLATPACK - NO LEAD

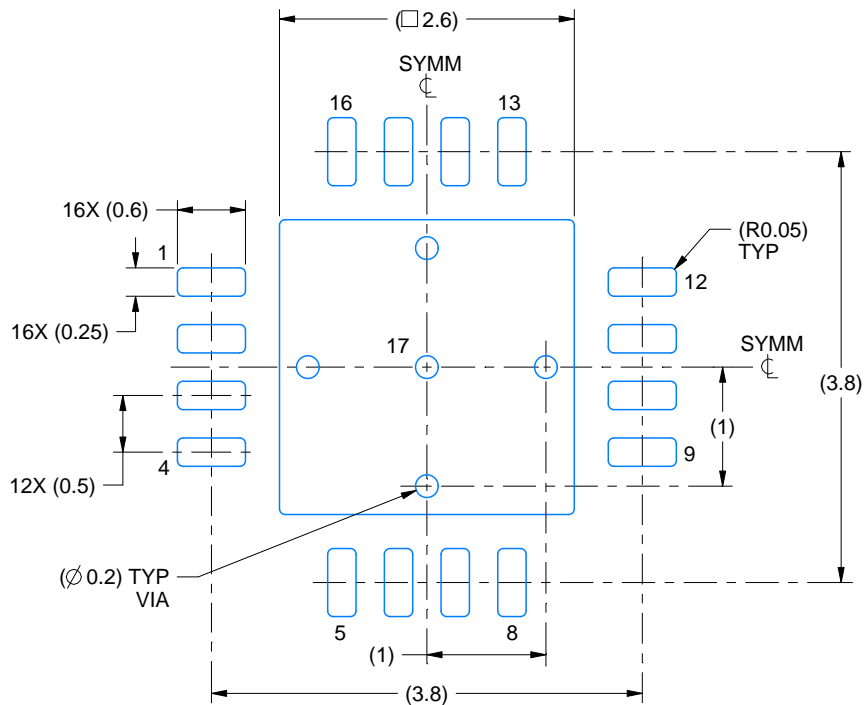

LAND PATTERN EXAMPLE
EXPOSED METAL SHOWN
SCALE:15X

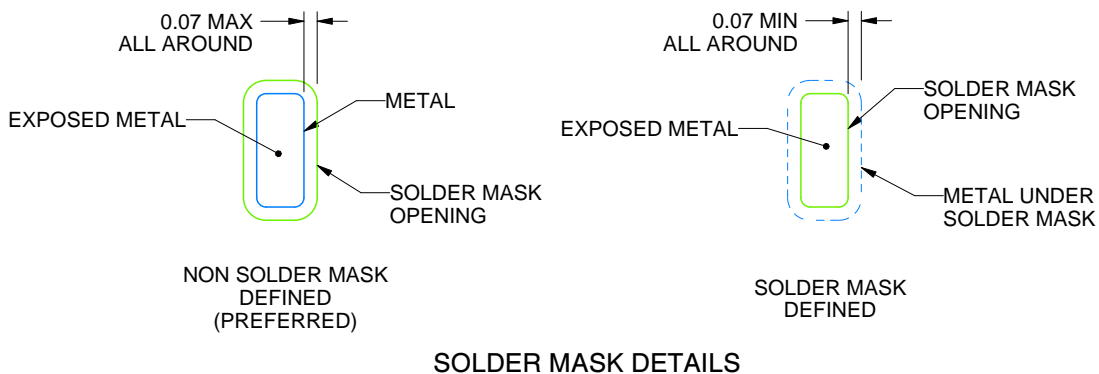

SOLDER MASK DETAILS

4214978/B 01/2017

NOTES: (continued)

4. This package is designed to be soldered to a thermal pad on the board. For more information, see Texas Instruments literature number SLUA271 (www.ti.com/lit/slua271).
5. Vias are optional depending on application, refer to device data sheet. If any vias are implemented, refer to their locations shown on this view. It is recommended that vias under paste be filled, plugged or tented.

IMPORTANT NOTICE

Texas Instruments Incorporated (TI) reserves the right to make corrections, enhancements, improvements and other changes to its semiconductor products and services per JESD46, latest issue, and to discontinue any product or service per JESD48, latest issue. Buyers should obtain the latest relevant information before placing orders and should verify that such information is current and complete.

TI's published terms of sale for semiconductor products (<http://www.ti.com/sc/docs/stdterms.htm>) apply to the sale of packaged integrated circuit products that TI has qualified and released to market. Additional terms may apply to the use or sale of other types of TI products and services.

Reproduction of significant portions of TI information in TI data sheets is permissible only if reproduction is without alteration and is accompanied by all associated warranties, conditions, limitations, and notices. TI is not responsible or liable for such reproduced documentation. Information of third parties may be subject to additional restrictions. Resale of TI products or services with statements different from or beyond the parameters stated by TI for that product or service voids all express and any implied warranties for the associated TI product or service and is an unfair and deceptive business practice. TI is not responsible or liable for any such statements.

Buyers and others who are developing systems that incorporate TI products (collectively, "Designers") understand and agree that Designers remain responsible for using their independent analysis, evaluation and judgment in designing their applications and that Designers have full and exclusive responsibility to assure the safety of Designers' applications and compliance of their applications (and of all TI products used in or for Designers' applications) with all applicable regulations, laws and other applicable requirements. Designer represents that, with respect to their applications, Designer has all the necessary expertise to create and implement safeguards that (1) anticipate dangerous consequences of failures, (2) monitor failures and their consequences, and (3) lessen the likelihood of failures that might cause harm and take appropriate actions. Designer agrees that prior to using or distributing any applications that include TI products, Designer will thoroughly test such applications and the functionality of such TI products as used in such applications.

TI's provision of technical, application or other design advice, quality characterization, reliability data or other services or information, including, but not limited to, reference designs and materials relating to evaluation modules, (collectively, "TI Resources") are intended to assist designers who are developing applications that incorporate TI products; by downloading, accessing or using TI Resources in any way, Designer (individually or, if Designer is acting on behalf of a company, Designer's company) agrees to use any particular TI Resource solely for this purpose and subject to the terms of this Notice.

TI's provision of TI Resources does not expand or otherwise alter TI's applicable published warranties or warranty disclaimers for TI products, and no additional obligations or liabilities arise from TI providing such TI Resources. TI reserves the right to make corrections, enhancements, improvements and other changes to its TI Resources. TI has not conducted any testing other than that specifically described in the published documentation for a particular TI Resource.

Designer is authorized to use, copy and modify any individual TI Resource only in connection with the development of applications that include the TI product(s) identified in such TI Resource. NO OTHER LICENSE, EXPRESS OR IMPLIED, BY ESTOPPEL OR OTHERWISE TO ANY OTHER TI INTELLECTUAL PROPERTY RIGHT, AND NO LICENSE TO ANY TECHNOLOGY OR INTELLECTUAL PROPERTY RIGHT OF TI OR ANY THIRD PARTY IS GRANTED HEREIN, including but not limited to any patent right, copyright, mask work right, or other intellectual property right relating to any combination, machine, or process in which TI products or services are used. Information regarding or referencing third-party products or services does not constitute a license to use such products or services, or a warranty or endorsement thereof. Use of TI Resources may require a license from a third party under the patents or other intellectual property of the third party, or a license from TI under the patents or other intellectual property of TI.

TI RESOURCES ARE PROVIDED "AS IS" AND WITH ALL FAULTS. TI DISCLAIMS ALL OTHER WARRANTIES OR REPRESENTATIONS, EXPRESS OR IMPLIED, REGARDING RESOURCES OR USE THEREOF, INCLUDING BUT NOT LIMITED TO ACCURACY OR COMPLETENESS, TITLE, ANY EPIDEMIC FAILURE WARRANTY AND ANY IMPLIED WARRANTIES OF MERCHANTABILITY, FITNESS FOR A PARTICULAR PURPOSE, AND NON-INFRINGEMENT OF ANY THIRD PARTY INTELLECTUAL PROPERTY RIGHTS. TI SHALL NOT BE LIABLE FOR AND SHALL NOT DEFEND OR INDEMNIFY DESIGNER AGAINST ANY CLAIM, INCLUDING BUT NOT LIMITED TO ANY INFRINGEMENT CLAIM THAT RELATES TO OR IS BASED ON ANY COMBINATION OF PRODUCTS EVEN IF DESCRIBED IN TI RESOURCES OR OTHERWISE. IN NO EVENT SHALL TI BE LIABLE FOR ANY ACTUAL, DIRECT, SPECIAL, COLLATERAL, INDIRECT, PUNITIVE, INCIDENTAL, CONSEQUENTIAL OR EXEMPLARY DAMAGES IN CONNECTION WITH OR ARISING OUT OF TI RESOURCES OR USE THEREOF, AND REGARDLESS OF WHETHER TI HAS BEEN ADVISED OF THE POSSIBILITY OF SUCH DAMAGES.

Unless TI has explicitly designated an individual product as meeting the requirements of a particular industry standard (e.g., ISO/TS 16949 and ISO 26262), TI is not responsible for any failure to meet such industry standard requirements.

Where TI specifically promotes products as facilitating functional safety or as compliant with industry functional safety standards, such products are intended to help enable customers to design and create their own applications that meet applicable functional safety standards and requirements. Using products in an application does not by itself establish any safety features in the application. Designers must ensure compliance with safety-related requirements and standards applicable to their applications. Designer may not use any TI products in life-critical medical equipment unless authorized officers of the parties have executed a special contract specifically governing such use. Life-critical medical equipment is medical equipment where failure of such equipment would cause serious bodily injury or death (e.g., life support, pacemakers, defibrillators, heart pumps, neurostimulators, and implantables). Such equipment includes, without limitation, all medical devices identified by the U.S. Food and Drug Administration as Class III devices and equivalent classifications outside the U.S.

TI may expressly designate certain products as completing a particular qualification (e.g., Q100, Military Grade, or Enhanced Product). Designers agree that it has the necessary expertise to select the product with the appropriate qualification designation for their applications and that proper product selection is at Designers' own risk. Designers are solely responsible for compliance with all legal and regulatory requirements in connection with such selection.

Designer will fully indemnify TI and its representatives against any damages, costs, losses, and/or liabilities arising out of Designer's non-compliance with the terms and provisions of this Notice.

Looking for pricing, stock, or lifecycle information?

Click below to explore more details on WIN SOURCE:

 [View LM4674SQ/NOPB on WIN SOURCE](#)

 [Texas Instruments](#) Information

Optimize Your Supply Chain with WIN SOURCE Solutions

-  Global Sourcing Solution
-  Obsolete Management
-  Cost Control Management
-  Shortage Management
-  Alternative Solution
-  Excess Inventory Management