



**THE DATASHEET OF  
LM4667MM/NOPB**



# LM4667 Boomer® Audio Power Amplifier Series **Filterless High Efficiency 1.3W Switching Audio Amplifier**

Check for Samples: [LM4667](#), [LM4667MMBD](#)

## FEATURES

- **No Output Filter Required for Inductive Transducers**
- **Selectable Gain of 6dB or 12dB**
- **Very Fast Turn on Time: 5ms (typ)**
- **Minimum External Components**
- **"Click and Pop" Suppression Circuitry**
- **Micro-Power Shutdown Mode**
- **Short Circuit Protection**
- **Space-Saving DSBGA and VSSOP Packages**

## KEY SPECIFICATIONS

- **Efficiency at 3V, 100mW into 8Ω Transducer 74% (typ)**
- **Efficiency at 3V, 450mW into 8Ω Transducer 84% (typ)**
- **Efficiency at 5V, 1W into 8Ω Transducer 86% (typ)**
- **Total Quiescent Power Supply Current: 3.5mA (typ)**
- **Total Shutdown Power Supply Current: 0.01μA (typ)**
- **Single Supply Range: 2.7V to 5.5V**

## APPLICATIONS

- **Mobile Phones**
- **PDA's**
- **Portable Electronic Devices**

## DESCRIPTION

The LM4667 is a fully integrated single-supply high efficiency switching audio amplifier. It features an innovative modulator that eliminates the LC output filter used with typical switching amplifiers. Eliminating the output filter reduces parts count, simplifies circuit design, and reduces board area. The LM4667 processes analog inputs with a delta-sigma modulation technique that lowers output noise and THD when compared to conventional pulse width modulators.

The LM4667 is designed to meet the demands of mobile phones and other portable communication devices. Operating on a single 3V supply, it is capable of driving 8Ω transducer loads at a continuous average output of 450mW with less than 1%THD+N. Its flexible power supply requirements allow operation from 2.7V to 5.5V.

The LM4667 has high efficiency with an 8Ω transducer load compared to a typical Class AB amplifier. With a 3V supply, the IC's efficiency for a 100mW power level is 74%, reaching 84% at 450mW output power.

The LM4667 features a low-power consumption shutdown mode. Shutdown may be enabled by driving the Shutdown pin to a logic low (GND).

The LM4667 has fixed selectable gain of either 6dB or 12dB. The LM4667 has short circuit protection against a short from the outputs to  $V_{DD}$ , GND, or across the outputs.



Please be aware that an important notice concerning availability, standard warranty, and use in critical applications of Texas Instruments semiconductor products and disclaimers thereto appears at the end of this data sheet.

All trademarks are the property of their respective owners.

Typical Application

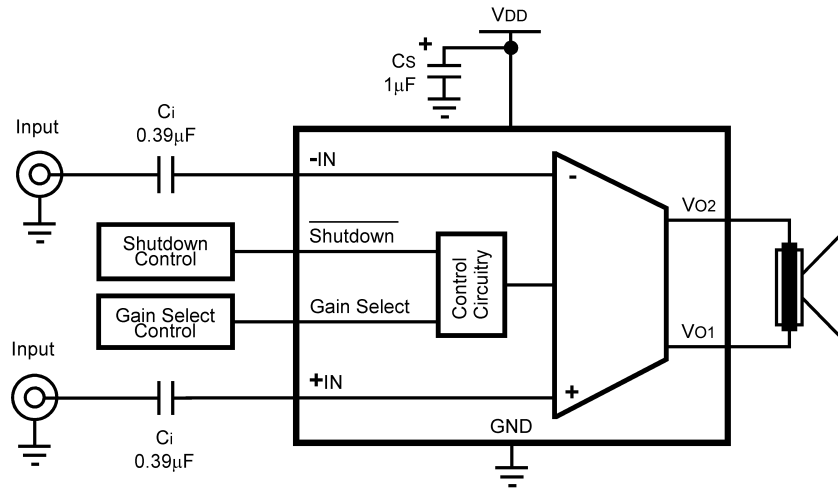

Figure 1. Typical Audio Amplifier Application Circuit

Connection Diagrams

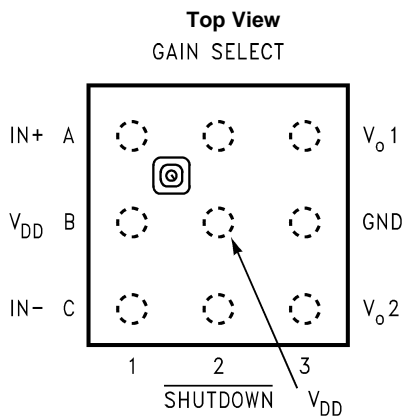

Figure 2. Bump DSBGA Package  
See Package Number YZR0009AAA

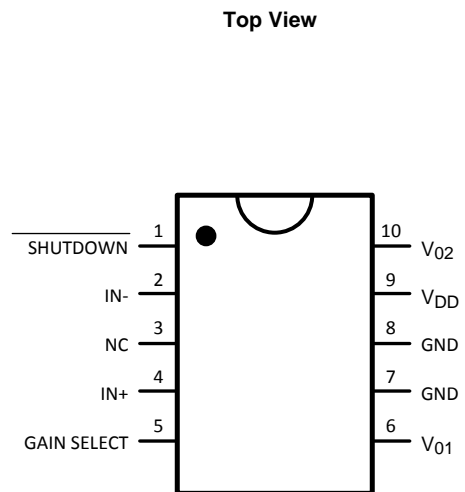

Figure 3. VSSOP Package  
See Package Number DGS0010A



These devices have limited built-in ESD protection. The leads should be shorted together or the device placed in conductive foam during storage or handling to prevent electrostatic damage to the MOS gates.

### Absolute Maximum Ratings<sup>(1)(2)(3)</sup>

Supply Voltage <sup>(1)</sup>		6.0V
Storage Temperature		-65°C to +150°C
Voltage at Any Input Pin		$V_{DD} + 0.3V \geq V \geq GND - 0.3V$
Power Dissipation <sup>(4)</sup>		Internally Limited
ESD Susceptibility <sup>(5)</sup>		7.0kV
ESD Susceptibility <sup>(6)</sup>		250V
Junction Temperature (T <sub>J</sub> )		150°C
Thermal Resistance	$\theta_{JA}$ (DSBGA)	220°C/W
	$\theta_{JA}$ (VSSOP)	190°C/W
	$\theta_{JC}$ (VSSOP)	56°C/W
Soldering Information: see <a href="#">AN-1112</a> "microSMD Wafers Level Chip Scale Package."		

- (1) All voltages are measured with respect to the ground pin, unless otherwise specified.
- (2) Absolute Maximum Ratings indicate limits beyond which damage to the device may occur. Operating Ratings indicate conditions for which the device is functional, but do not guarantee specific performance limits. Electrical Characteristics state DC and AC electrical specifications under particular test conditions which guarantee specific performance limits. This assumes that the device is within the Operating Ratings. Specifications are not guaranteed for parameters where no limit is given, however, the typical value is a good indication of device performance.
- (3) If Military/Aerospace specified devices are required, please contact the Texas Instruments Sales Office/ Distributors for availability and specifications.
- (4) The maximum power dissipation must be derated at elevated temperatures and is dictated by T<sub>JMAX</sub>,  $\theta_{JA}$ , and the ambient temperature T<sub>A</sub>. The maximum allowable power dissipation is  $P_{DMAX} = (T_{JMAX} - T_A) / \theta_{JA}$  or the number given in Absolute Maximum Ratings, whichever is lower. For the LM4667, T<sub>JMAX</sub> = 150°C. The typical  $\theta_{JA}$  is 220°C/W for the DSBGA package and 190°C/W for the VSSOP package.
- (5) Human body model, 100pF discharged through a 1.5k $\Omega$  resistor.
- (6) Machine Model, 220pF–240pF discharged through all pins.

### Operating Ratings<sup>(1)</sup>

Temperature Range	
$T_{MIN} \leq T_A \leq T_{MAX}$	-40°C ≤ T <sub>A</sub> ≤ 85°C
Supply Voltage	2.7V ≤ V <sub>DD</sub> ≤ 5.5V

- (1) Absolute Maximum Ratings indicate limits beyond which damage to the device may occur. Operating Ratings indicate conditions for which the device is functional, but do not guarantee specific performance limits. Electrical Characteristics state DC and AC electrical specifications under particular test conditions which guarantee specific performance limits. This assumes that the device is within the Operating Ratings. Specifications are not guaranteed for parameters where no limit is given, however, the typical value is a good indication of device performance.

**Electrical Characteristics  $V_{DD} = 5V^{(1)(2)}$** 

The following specifications apply for  $V_{DD} = 5V$  and  $R_L = 15\mu H + 8\Omega + 15\mu H$  unless otherwise specified. Limits apply for  $T_A = 25^\circ C$ .

Parameter		Test Conditions	LM4667		Units (Limits)
			Typ <sup>(3)</sup>	Limit <sup>(4)(5)</sup>	
$I_{DD}$	Quiescent Power Supply Current	$V_{IN} = 0V$ , No Load $V_{IN} = 0V$ , $R_L = 15\mu H + 8\Omega + 15\mu H$	8		mA
			9		mA
$I_{SD}$	Shutdown Current	$V_{SD} = GND^{(6)}$	0.01		$\mu A$
$V_{SDIH}$	Shutdown Voltage Input High		1.2		V
$V_{SDIL}$	Shutdown Voltage Input Low		1.1		V
$V_{GSIH}$	Gain Select Input High		1.2		V
$V_{GSIL}$	Gain Select Input Low		1.1		V
$A_V$	Closed Loop Gain	$V_{Gain\ Select} = V_{DD}$	6		dB
$A_V$	Closed Loop Gain	$V_{Gain\ Select} = GND$	12		dB
$V_{OS}$	Output Offset Voltage		10		mV
$T_{WU}$	Wake-up Time		5		ms
$P_o$	Output Power	THD = 2% (max), $f = 1kHz$	1.3		W
THD+N	Total Harmonic Distortion+Noise	$P_O = 100mW_{RMS}$ ; $f_{IN} = 1kHz$	0.8		%
$R_{IN}$	Differential Input Resistance	$V_{Gain\ Select} = V_{DD}$	90		k $\Omega$
		$V_{Gain\ Select} = GND$	60		k $\Omega$
PSRR	Power Supply Rejection Ratio	$V_{Ripple} = 100mV_{RMS}$ sine wave Inputs terminated to GND	55 ( $f = 217Hz$ )		dB
		$V_{Ripple} = 100mV_{RMS}$ sine wave $P_{OUT} = 10mW, 1kHz$	65 ( $f = 217Hz$ )		dB
CMRR	Common Mode Rejection Ratio	$V_{Ripple} = 100mV_{RMS}$ , $f_{Ripple} = 217Hz$	41		dB
SNR	Signal to Noise Ratio	$P_O = 1W_{RMS}$ ; A-Weighted Filter	83		dB
$\epsilon_{OUT}$	Output Noise	A-Weighted filter, $V_{in} = 0V$	200		$\mu V$

- (1) All voltages are measured with respect to the ground pin, unless otherwise specified.
- (2) Absolute Maximum Ratings indicate limits beyond which damage to the device may occur. Operating Ratings indicate conditions for which the device is functional, but do not guarantee specific performance limits. Electrical Characteristics state DC and AC electrical specifications under particular test conditions which guarantee specific performance limits. This assumes that the device is within the Operating Ratings. Specifications are not guaranteed for parameters where no limit is given, however, the typical value is a good indication of device performance.
- (3) Typical specifications are specified at  $25^\circ C$  and represent the parametric norm.
- (4) Tested limits are ensured to AOQL (Average Outgoing Quality Level).
- (5) Datasheet min/max specification limits are guaranteed by design, test, or statistical analysis.
- (6) Shutdown current is measured in a normal room environment. Exposure to direct sunlight will increase  $I_{SD}$  by a maximum of  $2\mu A$ . The Shutdown pin should be driven as close as possible to GND for minimal shutdown current and to  $V_{DD}$  for the best THD performance in PLAY mode. See the [SHUTDOWN FUNCTION](#) section under [Application Information](#) for more information.

**Electrical Characteristics  $V_{DD} = 3V^{(1)(2)}$** 

The following specifications apply for  $V_{DD} = 3V$  and  $R_L = 15\mu H + 8\Omega + 15\mu H$  unless otherwise specified. Limits apply for  $T_A = 25^\circ C$ .

Parameter		Test Conditions	LM4667		Units (Limits)
			Typ <sup>(3)</sup>	Limit <sup>(4)(5)</sup>	
$I_{DD}$	Quiescent Power Supply Current	$V_{IN} = 0V$ , No Load $V_{IN} = 0V$ , $R_L = 15\mu H + 8\Omega + 15\mu H$	3.50	5.0	mA (max)
			3.75		
$I_{SD}$	Shutdown Current	$V_{SD} = GND^{(6)}$	0.01	2.0	$\mu A$ (max)
$V_{SDIH}$	Shutdown Voltage Input High		1.0	1.4	V (min)
$V_{SDIL}$	Shutdown Voltage Input Low		0.8	0.4	V (max)
$V_{GSIH}$	Gain Select Input High		1.0	1.4	V (min)
$V_{GSIL}$	Gain Select Input Low		0.8	0.4	V (max)
$A_V$	Closed Loop Gain	$V_{Gain\ Select} = V_{DD}$	6	5.5 6.5	dB (min) dB (max)
				11.5 12.5	dB (min) dB (max)
$V_{OS}$	Output Offset Voltage		10	25	mV (max)
$T_{WU}$	Wake-up Time		5		ms
$P_o$	Output Power	THD = 1% (max); $f = 1kHz$	450	425	mW (min)
THD+N	Total Harmonic Distortion+Noise	$P_O = 100mW_{RMS}$ ; $f_{IN} = 1kHz$	0.35		%
$R_{IN}$	Differential Input Resistance	$V_{Gain\ Select} = V_{DD}$ $V_{Gain\ Select} = GND$	90		k $\Omega$
			60		k $\Omega$
PSRR	Power Supply Rejection Ratio	$V_{Ripple} = 100mV_{RMS}$ sine wave Inputs terminated to GND $V_{Ripple} = 100mV_{RMS}$ sine wave $P_{OUT} = 10mW, 1kHz$	56 ( $f = 217Hz$ )		dB
			65 ( $f = 217Hz$ )		dB
CMRR	Common Mode Rejection Ratio	$V_{Ripple} = 100mV_{RMS}$ , $f_{Ripple} = 217Hz$	41		dB
SNR	Signal to Noise Ratio	$P_O = 400mW_{RMS}$ , A-Weighted Filter	83		dB
$\epsilon_{OUT}$	Output Noise	A-Weighted filter, $V_{in} = 0V$	125		$\mu V$

- (1) All voltages are measured with respect to the ground pin, unless otherwise specified.
- (2) Absolute Maximum Ratings indicate limits beyond which damage to the device may occur. Operating Ratings indicate conditions for which the device is functional, but do not guarantee specific performance limits. Electrical Characteristics state DC and AC electrical specifications under particular test conditions which guarantee specific performance limits. This assumes that the device is within the Operating Ratings. Specifications are not guaranteed for parameters where no limit is given, however, the typical value is a good indication of device performance.
- (3) Typical specifications are specified at  $25^\circ C$  and represent the parametric norm.
- (4) Tested limits are ensured to AOQL (Average Outgoing Quality Level).
- (5) Datasheet min/max specification limits are guaranteed by design, test, or statistical analysis.
- (6) Shutdown current is measured in a normal room environment. Exposure to direct sunlight will increase  $I_{SD}$  by a maximum of  $2\mu A$ . The Shutdown pin should be driven as close as possible to GND for minimal shutdown current and to  $V_{DD}$  for the best THD performance in PLAY mode. See the [SHUTDOWN FUNCTION](#) section under [Application Information](#) for more information.

**External Components Description**

(See [Figure 1](#))

Components		Functional Description
1.	$C_S$	Supply bypass capacitor which provides power supply filtering. Refer to the <a href="#">Power Supply Bypassing</a> section for information concerning proper placement and selection of the supply bypass capacitor.
2.	$C_I$	Input AC coupling capacitor which blocks the DC voltage at the amplifier's input terminals.

**Typical Performance Characteristics**

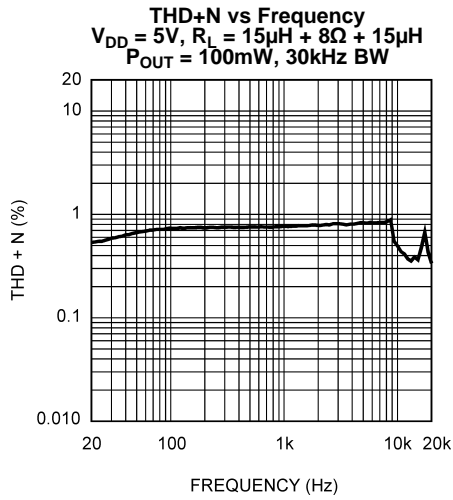

Figure 4.

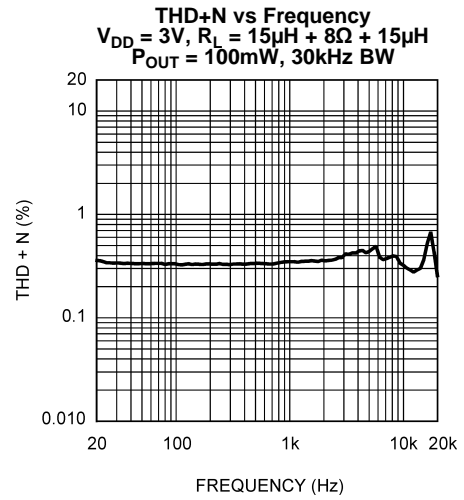

Figure 5.

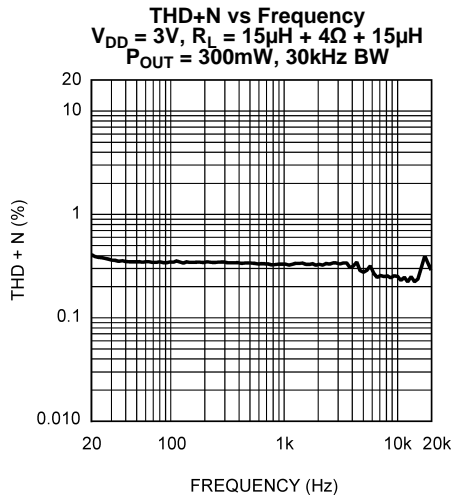

Figure 6.

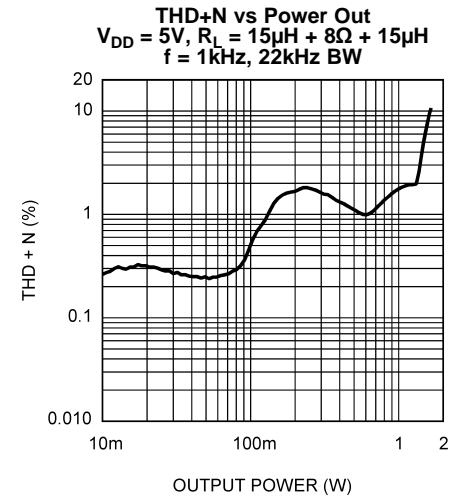

Figure 7.

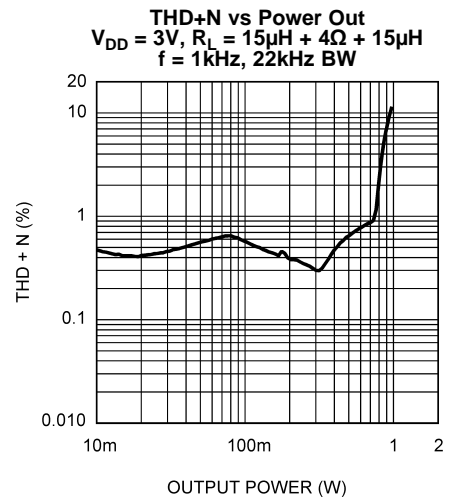

Figure 8.

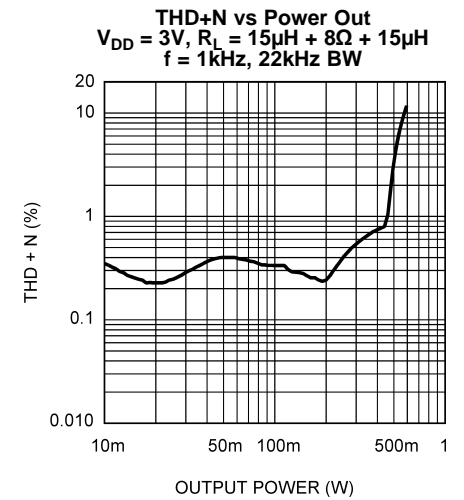

Figure 9.

Typical Performance Characteristics (continued)

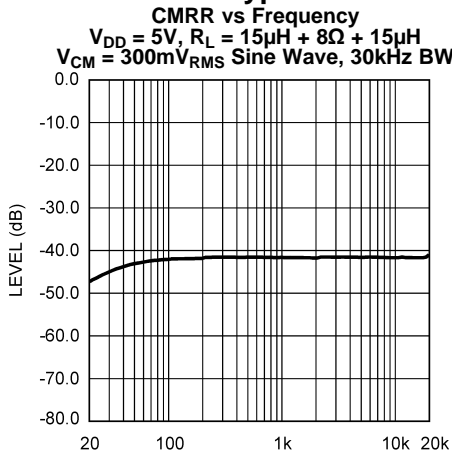

Figure 10.

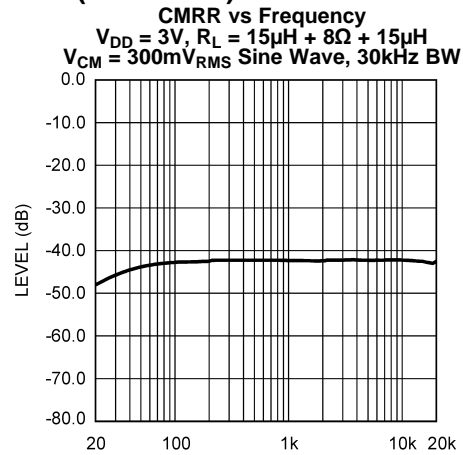

Figure 11.

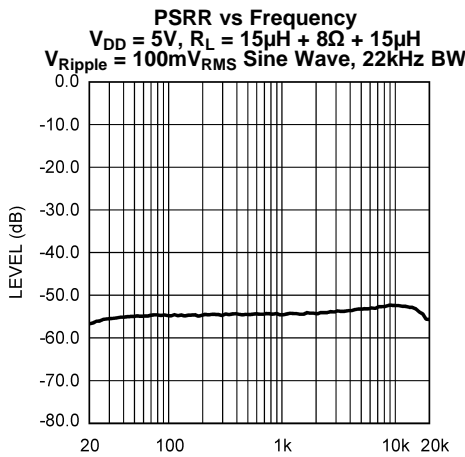

Figure 12.

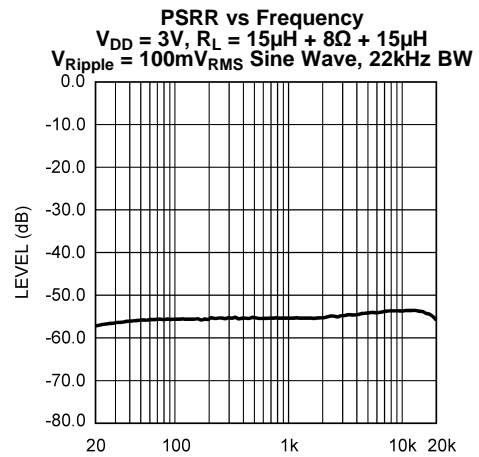

Figure 13.

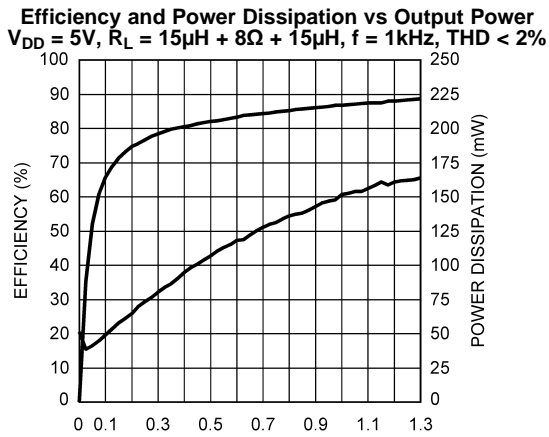

Figure 14.

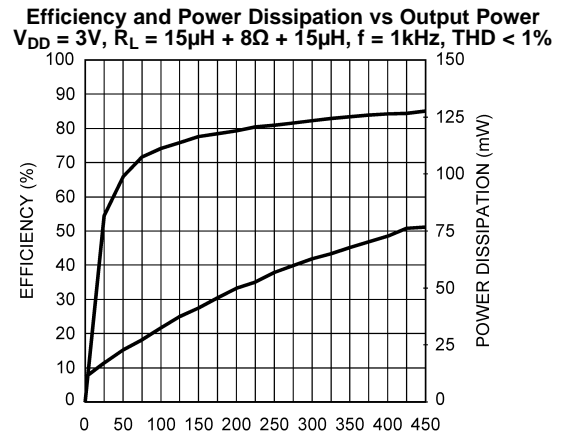

Figure 15.

Typical Performance Characteristics (continued)

Efficiency and Power Dissipation vs Output Power  
 $V_{DD} = 3V$ ,  $R_L = 15\mu H + 4\Omega + 15\mu H$ ,  $f = 1kHz$ , THD < 1%

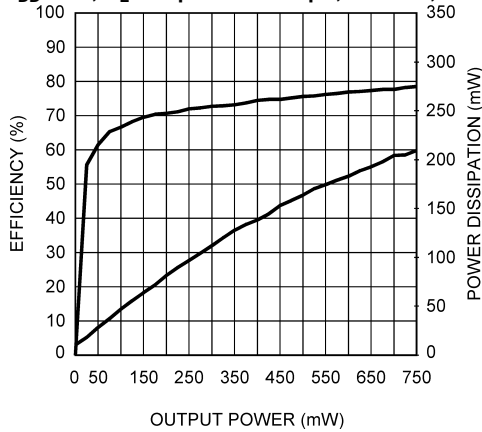

Figure 16.

Gain Select Threshold  
 $V_{DD} = 3V$

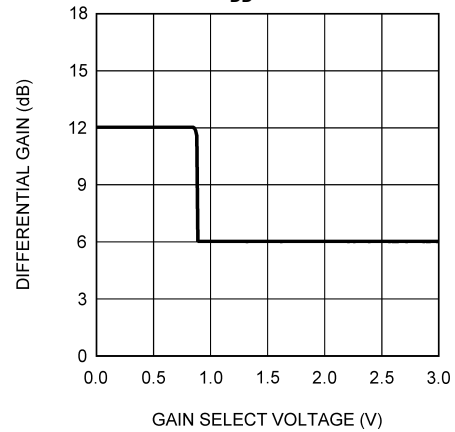

Figure 17.

Gain Select Threshold  
 $V_{DD} = 5V$

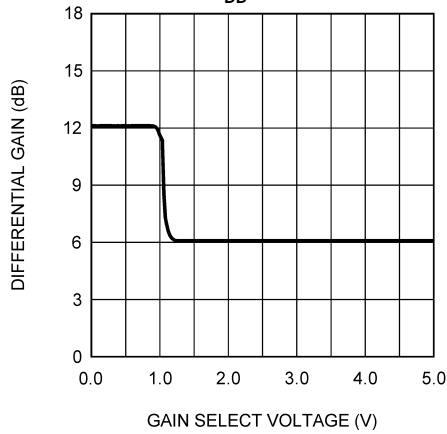

Figure 18.

Gain Select Threshold vs Supply Voltage  
 $R_L = 15\mu H + 8\Omega + 15\mu H$

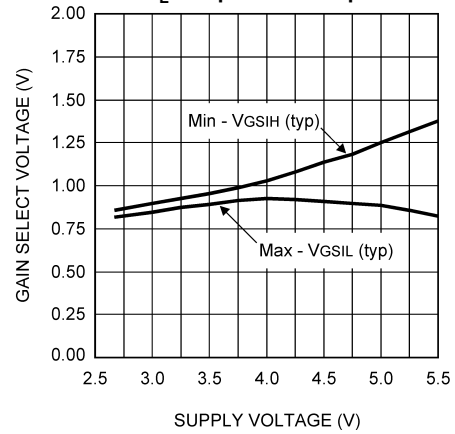

Figure 19.

Output Power vs Supply Voltage  
 $R_L = 15\mu H + 4\Omega + 15\mu H$ ,  $f = 1kHz$

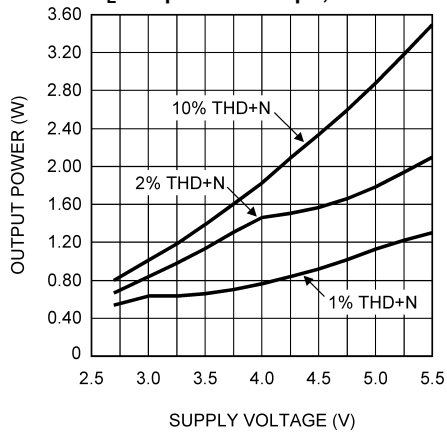

Figure 20.

Output Power vs Supply Voltage  
 $R_L = 15\mu H + 8\Omega + 15\mu H$ ,  $f = 1kHz$

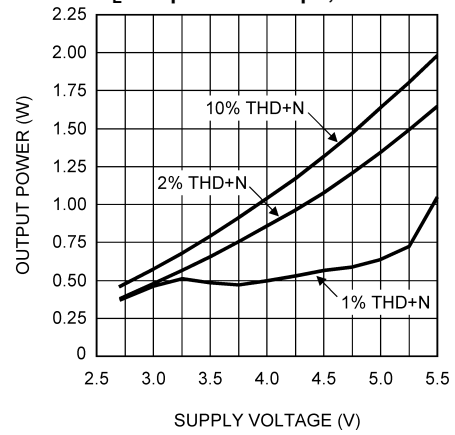
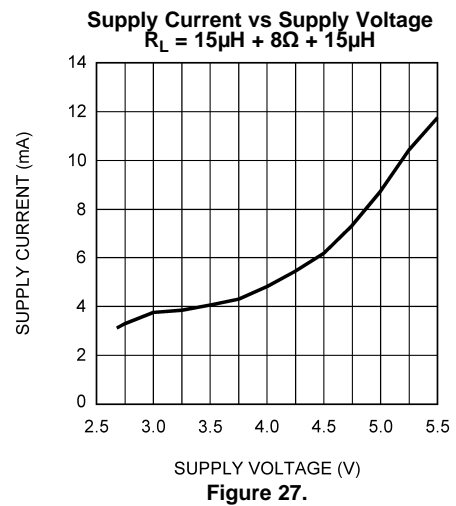
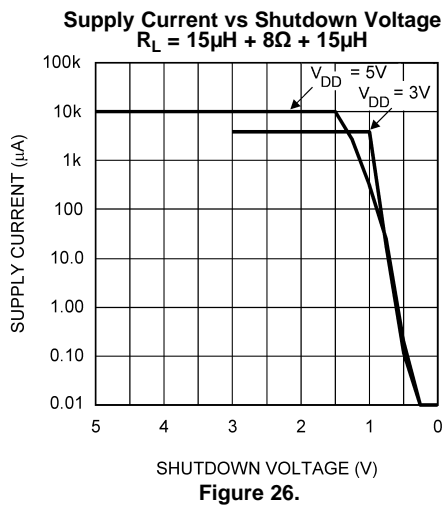
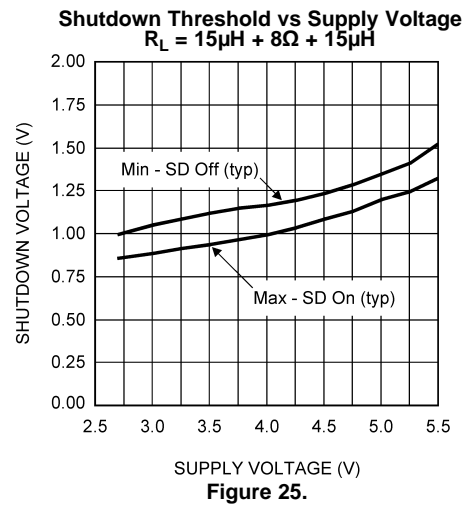
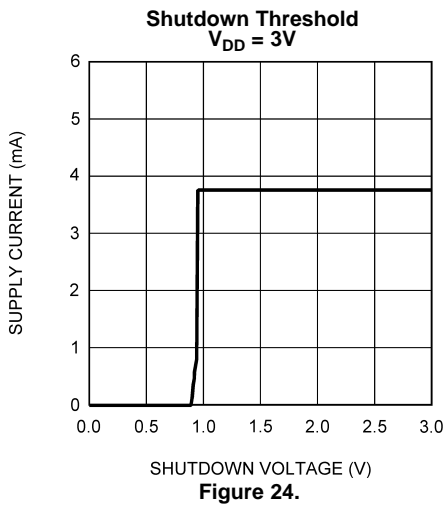
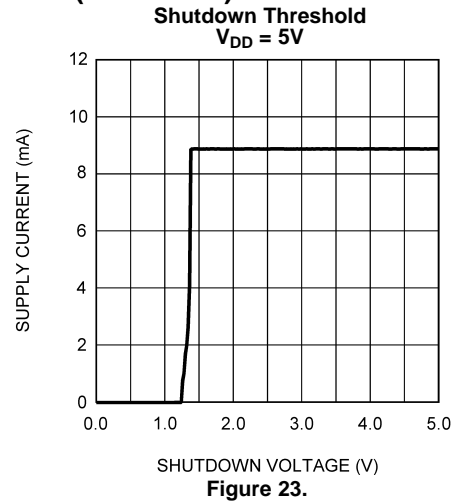
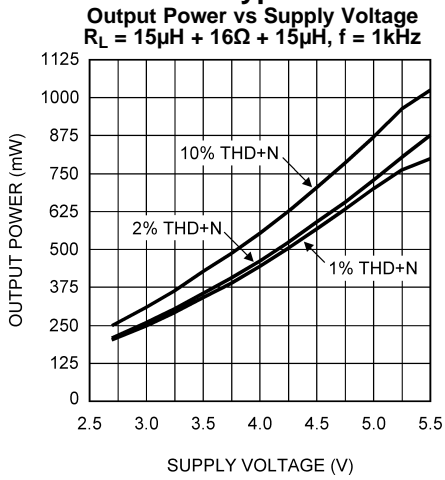

Figure 21.

Typical Performance Characteristics (continued)



## APPLICATION INFORMATION

### GENERAL AMPLIFIER FUNCTION

The output signals generated by the LM4667 consist of two, BTL connected, output signals that pulse momentarily from near ground potential to  $V_{DD}$ . The two outputs can pulse independently with the exception that they both may never pulse simultaneously as this would result in zero volts across the BTL load. The minimum width of each pulse is approximately 160ns. However, pulses on the same output can occur sequentially, in which case they are concatenated and appear as a single wider pulse to achieve an effective 100% duty cycle. This results in maximum audio output power for a given supply voltage and load impedance. The LM4667 can achieve much higher efficiencies than class AB amplifiers while maintaining acceptable THD performance.

The short (160ns) drive pulses emitted at the LM4667 outputs means that good efficiency can be obtained with minimal load inductance. The typical transducer load on an audio amplifier is quite reactive (inductive). For this reason, the load can act as its own filter, so to speak. This "filter-less" switching amplifier/transducer load combination is much more attractive economically due to savings in board space and external component cost by eliminating the need for a filter.

### POWER DISSIPATION AND EFFICIENCY

In general terms, efficiency is considered to be the ratio of useful work output divided by the total energy required to produce it with the difference being the power dissipated, typically, in the IC. The key here is "useful" work. For audio systems, the energy delivered in the audible bands is considered useful including the distortion products of the input signal. Sub-sonic (DC) and super-sonic components (>22kHz) are not useful. The difference between the power flowing from the power supply and the audio band power being transduced is dissipated in the LM4667 and in the transducer load. The amount of power dissipation in the LM4667 is very low. This is because the ON resistance of the switches used to form the output waveforms is typically less than  $0.25\Omega$ . This leaves only the transducer load as a potential "sink" for the small excess of input power over audio band output power. The LM4667 dissipates only a fraction of the excess power requiring no additional PCB area or copper plane to act as a heat sink.

### DIFFERENTIAL AMPLIFIER EXPLANATION

As logic supply voltages continue to shrink, designers are increasingly turning to differential analog signal handling to preserve signal to noise ratios with restricted voltage swing. The LM4667 is a fully differential amplifier that features differential input and output stages. A differential amplifier amplifies the difference between the two input signals. Traditional audio power amplifiers have typically offered only single-ended inputs resulting in a 6dB reduction in signal to noise ratio relative to differential inputs. The LM4667 also offers the possibility of DC input coupling which eliminates the two external AC coupling, DC blocking capacitors. The LM4667 can be used, however, as a single ended input amplifier while still retaining its fully differential benefits. In fact, completely unrelated signals may be placed on the input pins. The LM4667 simply amplifies the difference between the signals. A major benefit of a differential amplifier is the improved common mode rejection ratio (CMRR) over single input amplifiers. The common-mode rejection characteristic of the differential amplifier reduces sensitivity to ground offset related noise injection, especially important in high noise applications.

### PCB LAYOUT CONSIDERATIONS

As output power increases, interconnect resistance (PCB traces and wires) between the amplifier, load and power supply create a voltage drop. The voltage loss on the traces between the LM4667 and the load results in lower output power and decreased efficiency. Higher trace resistance between the supply and the LM4667 has the same effect as a poorly regulated supply, increase ripple on the supply line also reducing the peak output power. The effects of residual trace resistance increases as output current increases due to higher output power, decreased load impedance or both. To maintain the highest output voltage swing and corresponding peak output power, the PCB traces that connect the output pins to the load and the supply pins to the power supply should be as wide as possible to minimize trace resistance.

The rising and falling edges are necessarily short in relation to the minimum pulse width (160ns), having approximately 2ns rise and fall times, typical, depending on parasitic output capacitance. The inductive nature of the transducer load can also result in overshoot on one or both edges, clamped by the parasitic diodes to GND and  $V_{DD}$  in each case. From an EMI standpoint, this is an aggressive waveform that can radiate or conduct to other components in the system and cause interference. It is essential to keep the power and output traces short and well shielded if possible. Use of ground planes, beads, and micro-strip layout techniques are all useful in preventing unwanted interference.

## POWER SUPPLY BYPASSING

As with any power amplifier, proper supply bypassing is critical for low noise performance and high power supply rejection ratio (PSRR). The capacitor ( $C_S$ ) location should be as close as possible to the LM4667. Typical applications employ a voltage regulator with a 10 $\mu$ F and a 0.1 $\mu$ F bypass capacitors that increase supply stability. These capacitors do not eliminate the need for bypassing on the supply pin of the LM4667. A 1 $\mu$ F tantalum capacitor is recommended.

## SHUTDOWN FUNCTION

In order to reduce power consumption while not in use, the LM4667 contains shutdown circuitry that reduces current draw to less than 0.01 $\mu$ A. The trigger point for shutdown is shown as a typical value in the Electrical Characteristics Tables and in the Shutdown Hysteresis Voltage graphs found in the [Typical Performance Characteristics](#) section. It is best to switch between ground and supply for minimum current usage while in the shutdown state. While the LM4667 may be disabled with shutdown voltages in between ground and supply, the idle current will be greater than the typical 0.01 $\mu$ A value. Increased THD may also be observed with voltages less than  $V_{DD}$  on the Shutdown pin when in PLAY mode.

The LM4667 has an internal resistor connected between GND and Shutdown pins. The purpose of this resistor is to eliminate any unwanted state changes when the Shutdown pin is floating. The LM4667 will enter the shutdown state when the Shutdown pin is left floating or if not floating, when the shutdown voltage has crossed the threshold. To minimize the supply current while in the shutdown state, the Shutdown pin should be driven to GND or left floating. If the Shutdown pin is not driven to GND, the amount of additional resistor current due to the internal shutdown resistor can be found by Equation (1) below.

$$(V_{SD} - GND) / 60k\Omega \quad (1)$$

With only a 0.5V difference, an additional 8.3 $\mu$ A of current will be drawn while in the shutdown state.

## GAIN SELECTION FUNCTION

The LM4667 has fixed selectable gain to minimize external components, increase flexibility and simplify design. For a differential gain of 6dB, the Gain Select pin should be permanently connected to  $V_{DD}$  or driven to a logic high level. For a differential gain of 12dB, the Gain Select pin should be permanently connected to GND or driven to a logic low level. The gain of the LM4667 can be switched while the amplifier is in PLAY mode driving a load with a signal without damage to the IC. The voltage on the Gain Select pin should be switched quickly between GND (logic low) and  $V_{DD}$  (logic high) to eliminate any possible audible artifacts from appearing at the output. For typical threshold voltages for the Gain Select function, refer to the Gain Threshold Voltages graph in the [Typical Performance Characteristics](#) section.

**SINGLE-ENDED CIRCUIT CONFIGURATIONS**

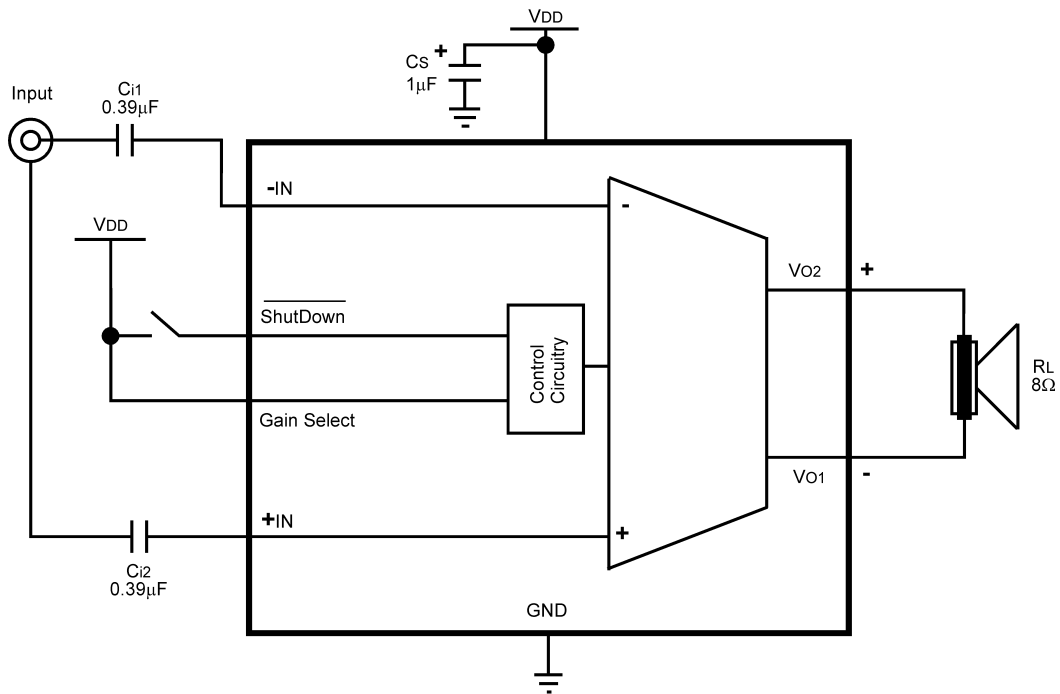

**Figure 28. Single-Ended Input with Low Gain Selection Configuration**

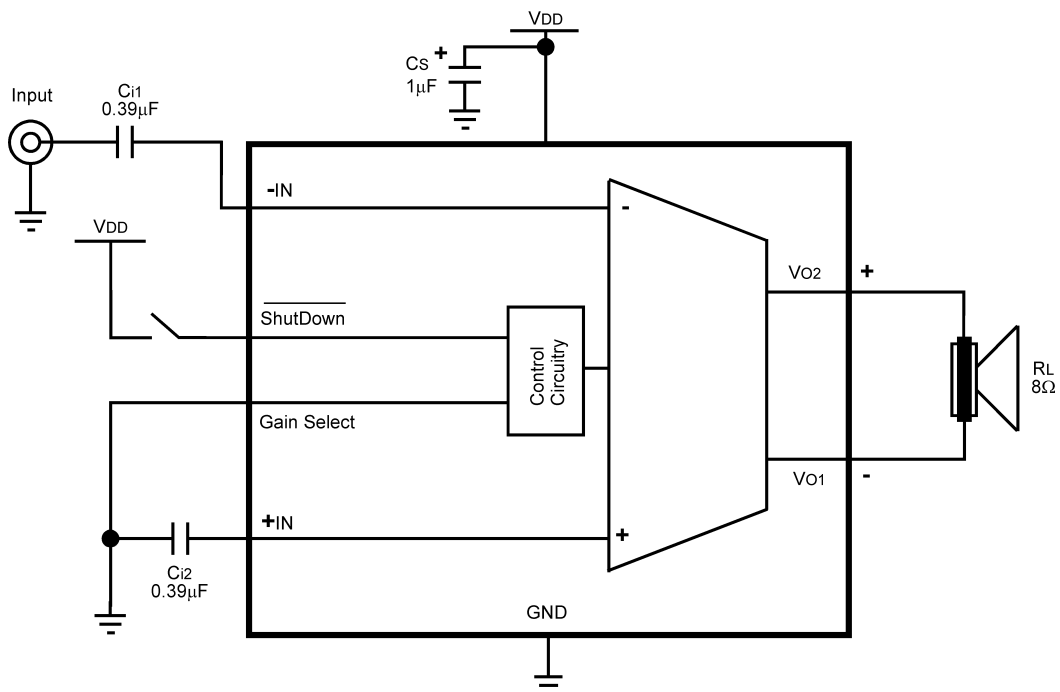

**Figure 29. Single-Ended Input with High Gain Selection Configuration**

## REFERENCE DESIGN BOARD SCHEMATIC

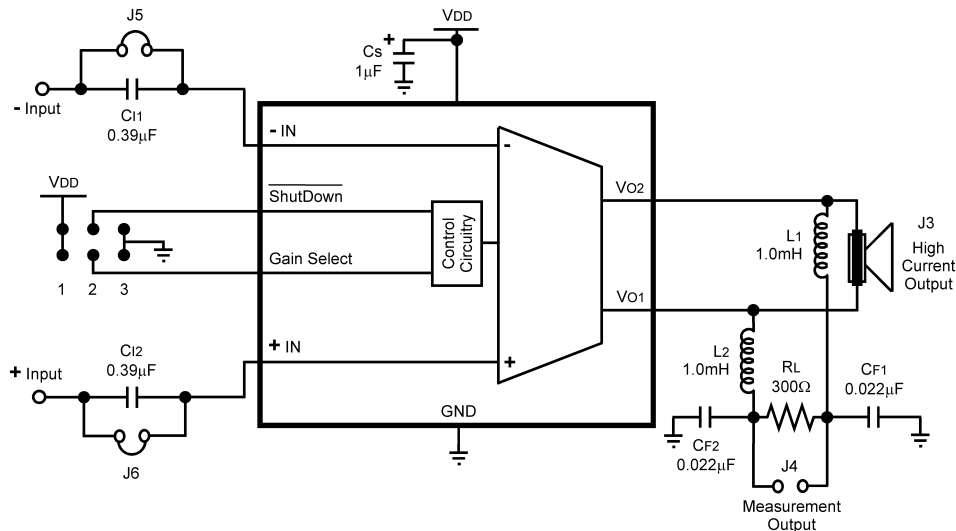

Figure 30.

In addition to the minimal parts required for the application circuit, a measurement filter is provided on the evaluation circuit board so that conventional audio measurements can be conveniently made without additional equipment. This is a balanced input / grounded differential output low pass filter with a 3dB frequency of approximately 35kHz and an on board termination resistor of 300Ω (see Figure 30). Note that the capacitive load elements are returned to ground. This is not optimal for common mode rejection purposes, but due to the independent pulse format at each output there is a significant amount of high frequency common mode component on the outputs. The grounded capacitive filter elements attenuate this component at the board to reduce the high frequency CMRR requirement placed on the analysis instruments.

Even with the grounded filter the audio signal is still differential, necessitating a differential input on any analysis instrument connected to it. Most lab instruments that feature BNC connectors on their inputs are **NOT** differential responding because the ring of the BNC is usually grounded.

The commonly used Audio Precision analyzer is differential, but its ability to accurately reject fast pulses of 160nS width is questionable necessitating the on board measurement filter. When in doubt or when the signal needs to be single-ended, use an audio signal transformer to convert the differential output to a single ended output. Depending on the audio transformer's characteristics, there may be some attenuation of the audio signal which needs to be taken into account for correct measurement of performance.

Measurements made at the output of the measurement filter suffer attenuation relative to the primary, unfiltered outputs even at audio frequencies. This is due to the resistance of the inductors interacting with the termination resistor (300Ω) and is typically about -0.35dB (4%). In other words, the voltage levels (and corresponding power levels) indicated through the measurement filter are slightly lower than those that actually occur at the load placed on the unfiltered outputs. This small loss in the filter for measurement gives a lower output power reading than what is really occurring on the unfiltered outputs and its load.

LM4667 DSBGA BOARD ARTWORK

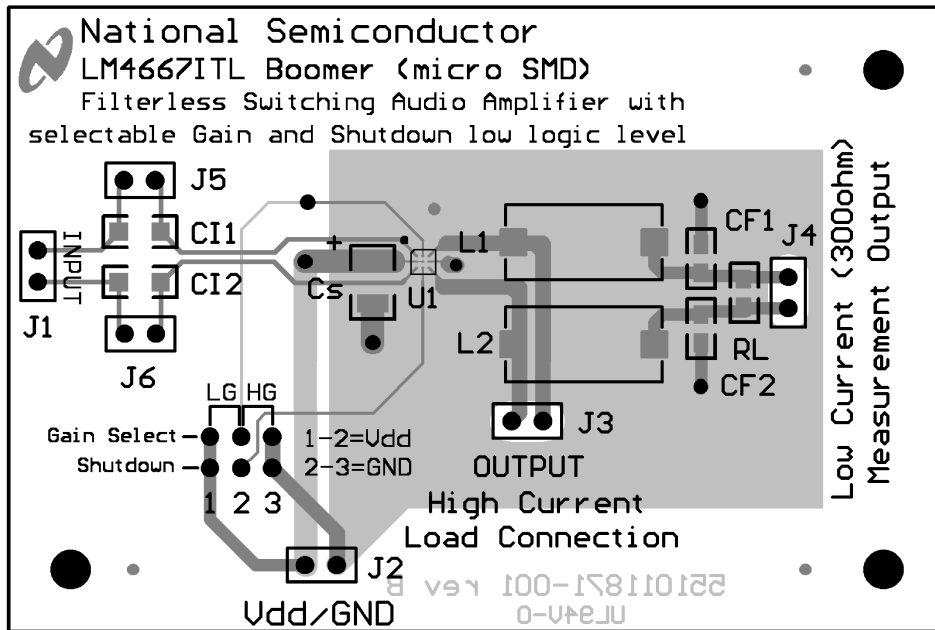

Figure 31. Composite View

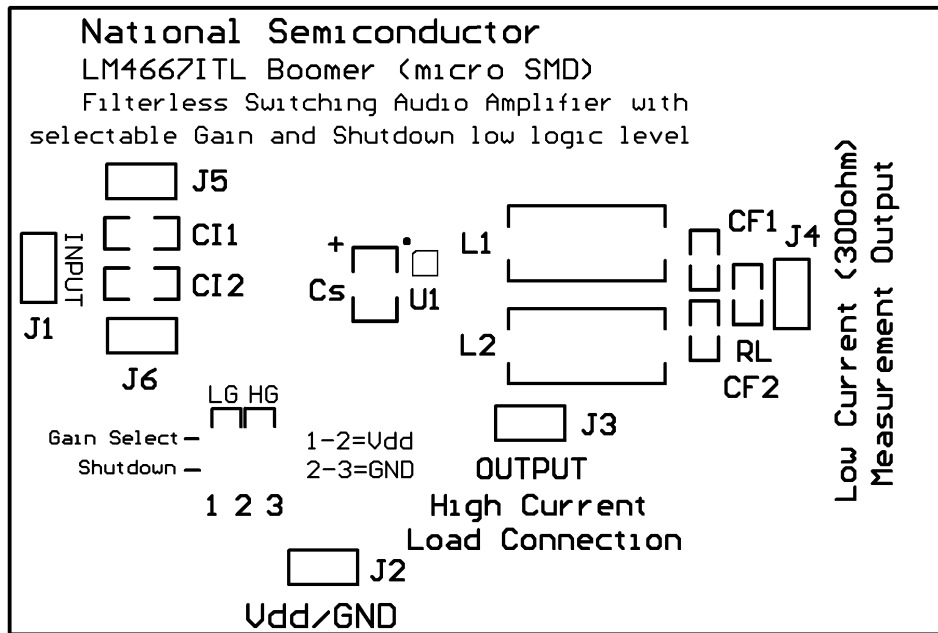

Figure 32. Silk Screen

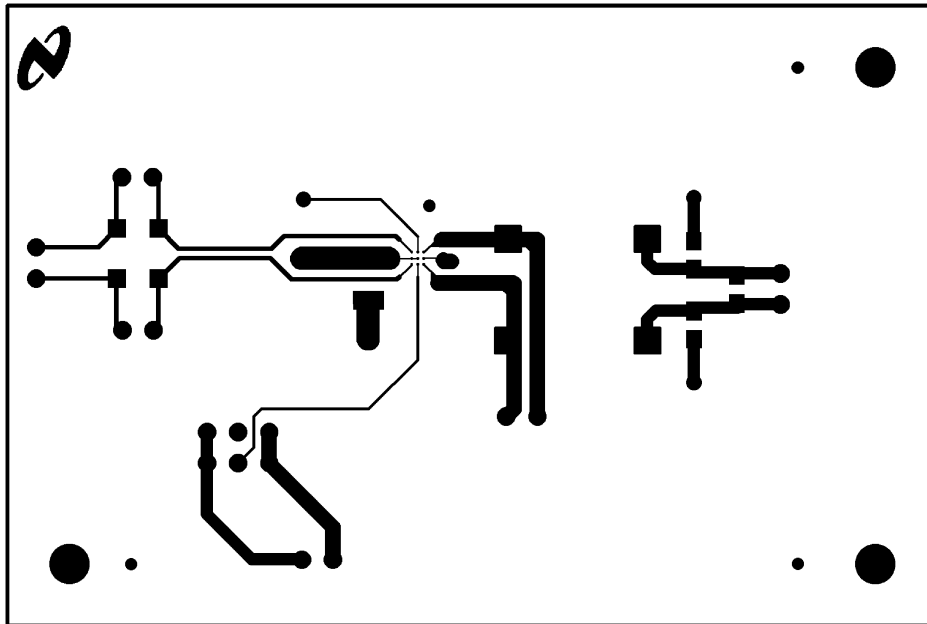

Figure 33. Top Layer

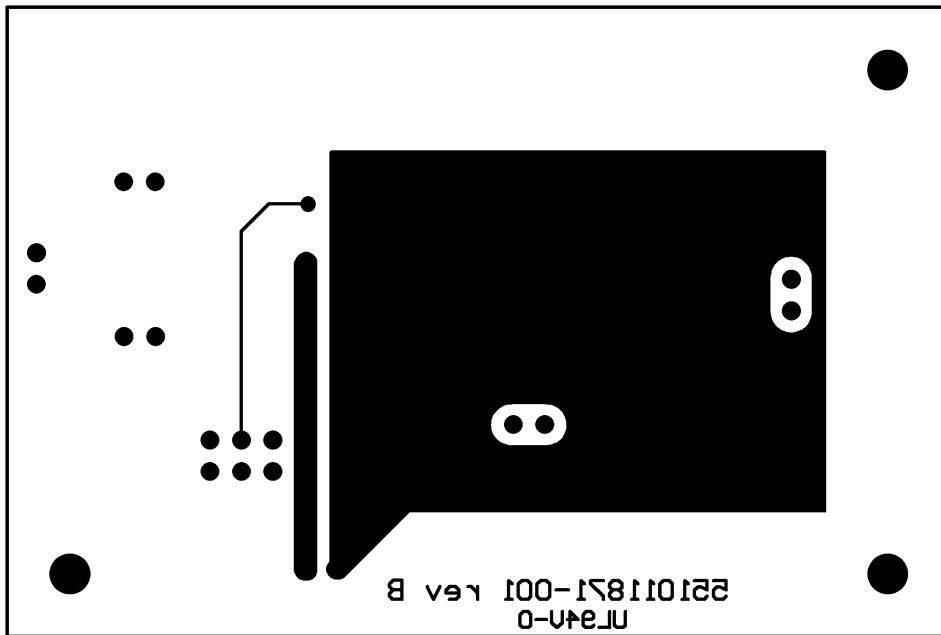

Figure 34. Bottom Layer

LM4667 VSSOP BOARD ARTWORK

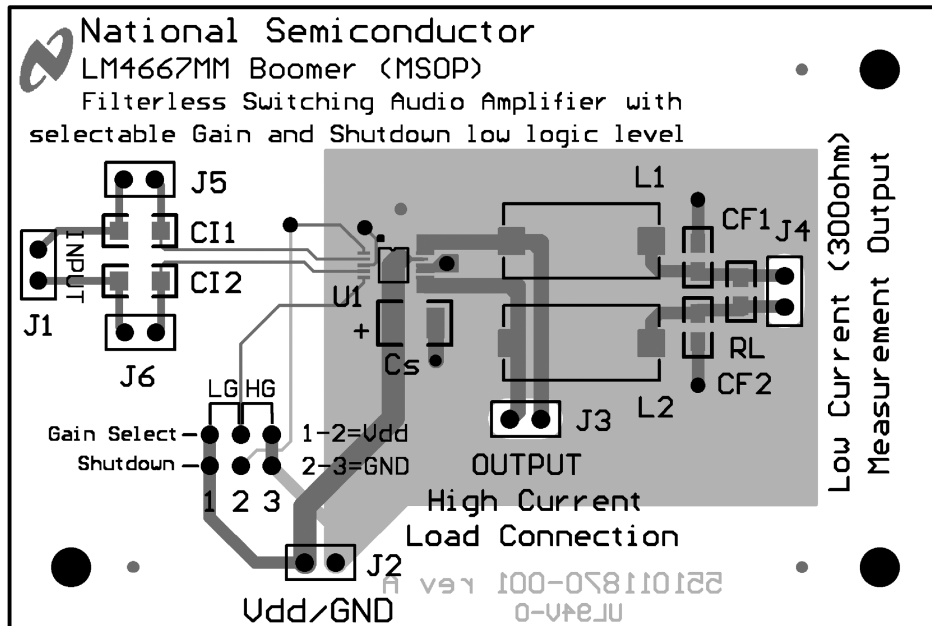

Figure 35. Composite View

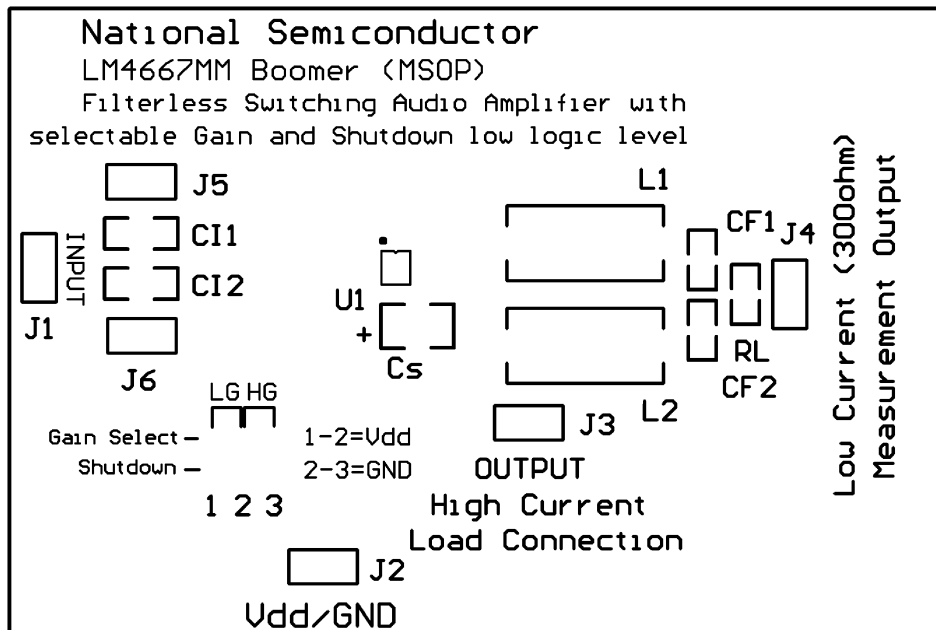

Figure 36. Silk Screen

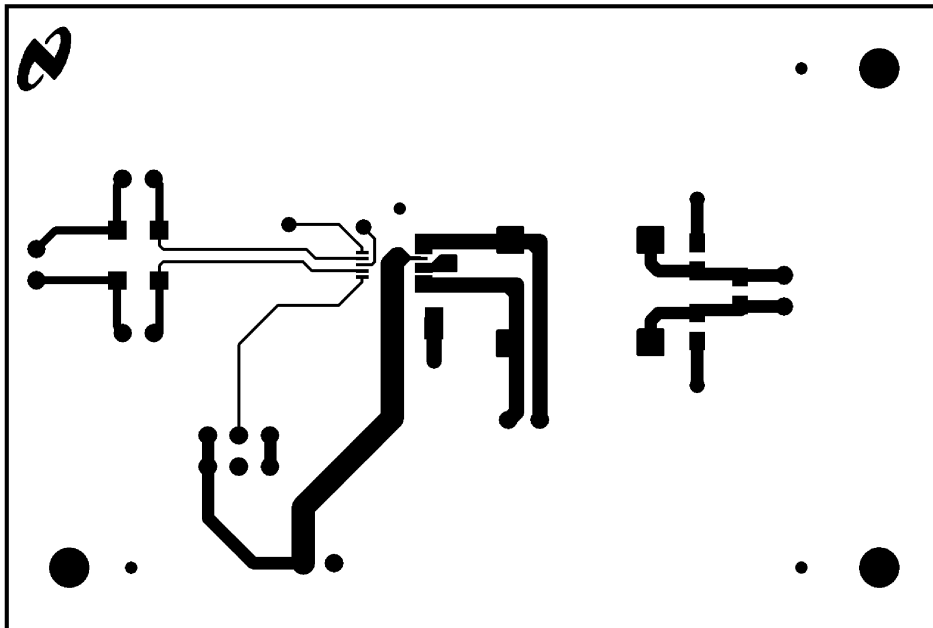

Figure 37. Top Layer

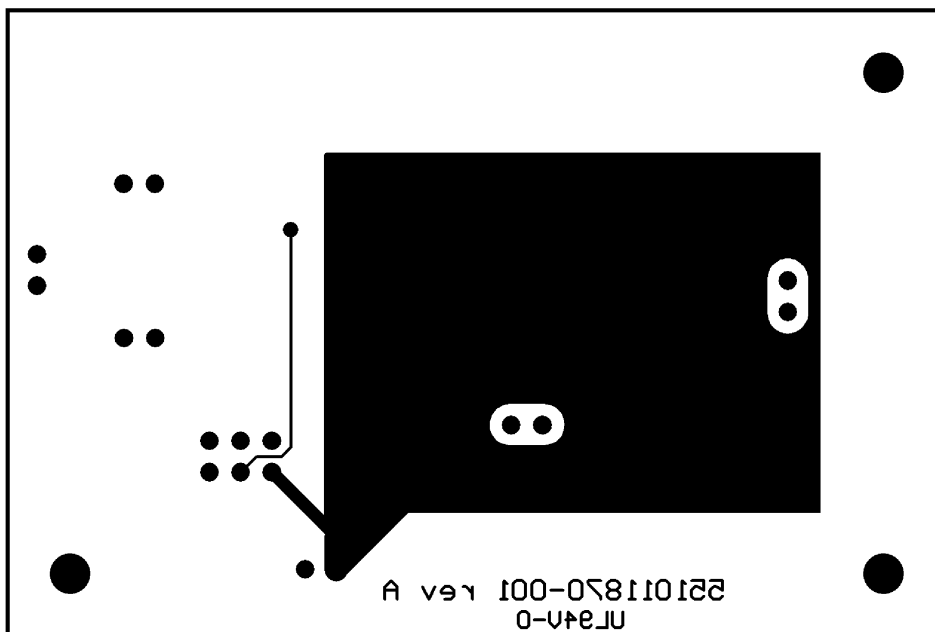

Figure 38. Bottom Layer

## REVISION HISTORY

Changes from Revision B (May 2013) to Revision C	Page
• Changed layout of National Data Sheet to TI format .....	17

**PACKAGING INFORMATION**

Orderable Device	Status (1)	Package Type	Package Drawing	Pins	Package Qty	Eco Plan (2)	Lead/Ball Finish	MSL Peak Temp (3)	Op Temp (°C)	Device Marking (4/5)	Samples
LM4667ITL/NOPB	ACTIVE	DSBGA	YZR	9	250	Green (RoHS & no Sb/Br)	SNAGCU	Level-1-260C-UNLIM	-40 to 85	G B4	<a href="#">Samples</a>
LM4667MM/NOPB	ACTIVE	VSSOP	DGS	10	1000	Green (RoHS & no Sb/Br)	CU SN	Level-1-260C-UNLIM	-40 to 85	GA6	<a href="#">Samples</a>

(1) The marketing status values are defined as follows:

**ACTIVE:** Product device recommended for new designs.

**LIFEBUY:** TI has announced that the device will be discontinued, and a lifetime-buy period is in effect.

**NRND:** Not recommended for new designs. Device is in production to support existing customers, but TI does not recommend using this part in a new design.

**PREVIEW:** Device has been announced but is not in production. Samples may or may not be available.

**OBsolete:** TI has discontinued the production of the device.

(2) Eco Plan - The planned eco-friendly classification: Pb-Free (RoHS), Pb-Free (RoHS Exempt), or Green (RoHS & no Sb/Br) - please check <http://www.ti.com/productcontent> for the latest availability information and additional product content details.

**TBD:** The Pb-Free/Green conversion plan has not been defined.

**Pb-Free (RoHS):** TI's terms "Lead-Free" or "Pb-Free" mean semiconductor products that are compatible with the current RoHS requirements for all 6 substances, including the requirement that lead not exceed 0.1% by weight in homogeneous materials. Where designed to be soldered at high temperatures, TI Pb-Free products are suitable for use in specified lead-free processes.

**Pb-Free (RoHS Exempt):** This component has a RoHS exemption for either 1) lead-based flip-chip solder bumps used between the die and package, or 2) lead-based die adhesive used between the die and leadframe. The component is otherwise considered Pb-Free (RoHS compatible) as defined above.

**Green (RoHS & no Sb/Br):** TI defines "Green" to mean Pb-Free (RoHS compatible), and free of Bromine (Br) and Antimony (Sb) based flame retardants (Br or Sb do not exceed 0.1% by weight in homogeneous material)

(3) MSL, Peak Temp. -- The Moisture Sensitivity Level rating according to the JEDEC industry standard classifications, and peak solder temperature.

(4) There may be additional marking, which relates to the logo, the lot trace code information, or the environmental category on the device.

(5) Multiple Device Markings will be inside parentheses. Only one Device Marking contained in parentheses and separated by a "~" will appear on a device. If a line is indented then it is a continuation of the previous line and the two combined represent the entire Device Marking for that device.

**Important Information and Disclaimer:** The information provided on this page represents TI's knowledge and belief as of the date that it is provided. TI bases its knowledge and belief on information provided by third parties, and makes no representation or warranty as to the accuracy of such information. Efforts are underway to better integrate information from third parties. TI has taken and continues to take reasonable steps to provide representative and accurate information but may not have conducted destructive testing or chemical analysis on incoming materials and chemicals. TI and TI suppliers consider certain information to be proprietary, and thus CAS numbers and other limited information may not be available for release.

In no event shall TI's liability arising out of such information exceed the total purchase price of the TI part(s) at issue in this document sold by TI to Customer on an annual basis.

## TAPE AND REEL INFORMATION



### QUADRANT ASSIGNMENTS FOR PIN 1 ORIENTATION IN TAPE



\*All dimensions are nominal

Device	Package Type	Package Drawing	Pins	SPQ	Reel Diameter (mm)	Reel Width W1 (mm)	A0 (mm)	B0 (mm)	K0 (mm)	P1 (mm)	W (mm)	Pin1 Quadrant
LM4667ITL/NOPB	DSBGA	YZR	9	250	178.0	8.4	1.7	1.7	0.76	4.0	8.0	Q1
LM4667MM/NOPB	VSSOP	DGS	10	1000	178.0	12.4	5.3	3.4	1.4	8.0	12.0	Q1

TAPE AND REEL BOX DIMENSIONS



\*All dimensions are nominal

Device	Package Type	Package Drawing	Pins	SPQ	Length (mm)	Width (mm)	Height (mm)
LM4667ITL/NOPB	DSBGA	YZR	9	250	210.0	185.0	35.0
LM4667MM/NOPB	VSSOP	DGS	10	1000	210.0	185.0	35.0

# DGS0010A



# PACKAGE OUTLINE

## VSSOP - 1.1 mm max height

SMALL OUTLINE PACKAGE



4221984/A 05/2015

### NOTES:

1. All linear dimensions are in millimeters. Any dimensions in parenthesis are for reference only. Dimensioning and tolerancing per ASME Y14.5M.
2. This drawing is subject to change without notice.
3. This dimension does not include mold flash, protrusions, or gate burrs. Mold flash, protrusions, or gate burrs shall not exceed 0.15 mm per side.
4. This dimension does not include interlead flash. Interlead flash shall not exceed 0.25 mm per side.
5. Reference JEDEC registration MO-187, variation BA.

# EXAMPLE BOARD LAYOUT

DGS0010A

VSSOP - 1.1 mm max height

SMALL OUTLINE PACKAGE



LAND PATTERN EXAMPLE  
SCALE:10X

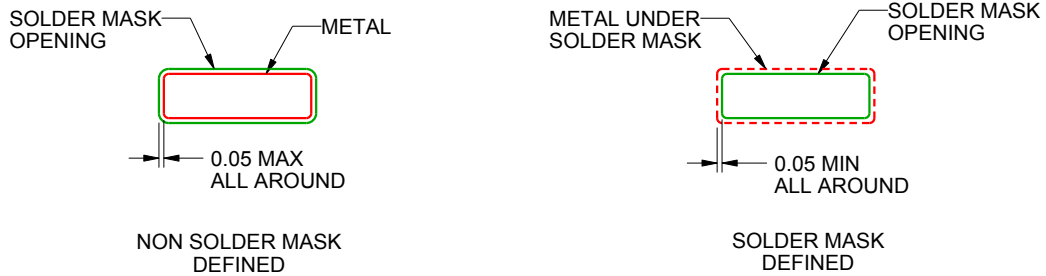

SOLDER MASK DETAILS  
NOT TO SCALE

4221984/A 05/2015

NOTES: (continued)

- 6. Publication IPC-7351 may have alternate designs.
- 7. Solder mask tolerances between and around signal pads can vary based on board fabrication site.

# EXAMPLE STENCIL DESIGN

DGS0010A

VSSOP - 1.1 mm max height

SMALL OUTLINE PACKAGE



SOLDER PASTE EXAMPLE  
BASED ON 0.125 mm THICK STENCIL  
SCALE:10X

4221984/A 05/2015

NOTES: (continued)

8. Laser cutting apertures with trapezoidal walls and rounded corners may offer better paste release. IPC-7525 may have alternate design recommendations.
9. Board assembly site may have different recommendations for stencil design.

YZR0009

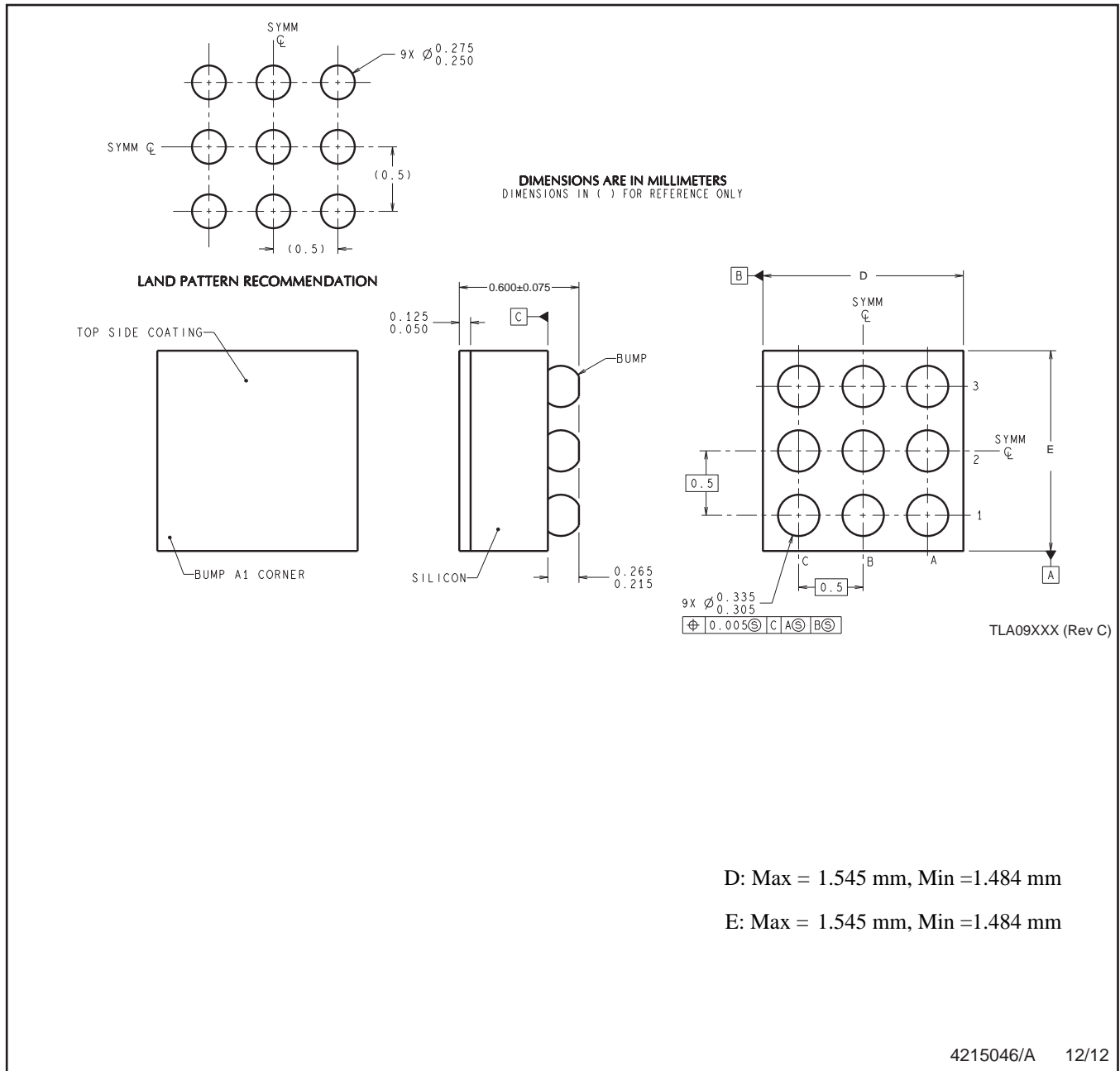

NOTES: A. All linear dimensions are in millimeters. Dimensioning and tolerancing per ASME Y14.5M-1994.  
B. This drawing is subject to change without notice.

## IMPORTANT NOTICE AND DISCLAIMER

TI PROVIDES TECHNICAL AND RELIABILITY DATA (INCLUDING DATASHEETS), DESIGN RESOURCES (INCLUDING REFERENCE DESIGNS), APPLICATION OR OTHER DESIGN ADVICE, WEB TOOLS, SAFETY INFORMATION, AND OTHER RESOURCES "AS IS" AND WITH ALL FAULTS, AND DISCLAIMS ALL WARRANTIES, EXPRESS AND IMPLIED, INCLUDING WITHOUT LIMITATION ANY IMPLIED WARRANTIES OF MERCHANTABILITY, FITNESS FOR A PARTICULAR PURPOSE OR NON-INFRINGEMENT OF THIRD PARTY INTELLECTUAL PROPERTY RIGHTS.



These resources are intended for skilled developers designing with TI products. You are solely responsible for (1) selecting the appropriate TI products for your application, (2) designing, validating and testing your application, and (3) ensuring your application meets applicable standards, and any other safety, security, or other requirements. These resources are subject to change without notice. TI grants you permission to use these resources only for development of an application that uses the TI products described in the resource. Other reproduction and display of these resources is prohibited. No license is granted to any other TI intellectual property right or to any third party intellectual property right. TI disclaims responsibility for, and you will fully indemnify TI and its representatives against, any claims, damages, costs, losses, and liabilities arising out of your use of these resources.

TI's products are provided subject to TI's Terms of Sale ([www.ti.com/legal/termsofsale.html](http://www.ti.com/legal/termsofsale.html)) or other applicable terms available either on [ti.com](http://ti.com) or provided in conjunction with such TI products. TI's provision of these resources does not expand or otherwise alter TI's applicable warranties or warranty disclaimers for TI products.

Mailing Address: Texas Instruments, Post Office Box 655303, Dallas, Texas 75265  
Copyright © 2018, Texas Instruments Incorporated

## Looking for pricing, stock, or lifecycle information?

Click below to explore more details on WIN SOURCE:

-  [View LM4667MM/NOPB on WIN SOURCE](#)
-  [Texas Instruments](#) Information

## Optimize Your Supply Chain with WIN SOURCE Solutions

-  Global Sourcing Solution
-  Obsolete Management
-  Cost Control Management
-  Shortage Management
-  Alternative Solution
-  Excess Inventory Management