



THE DATASHEET OF LM4041CIDBZR



FEATURES

- 1.225-V Fixed and Adjustable Outputs (1.225 V to 10 V)
- Tight Output Tolerances and Low Temperature Coefficient
 - Max 0.1%, 100 ppm/°C – A Grade
 - Max 0.2%, 100 ppm/°C – B Grade
 - Max 0.5%, 100 ppm/°C – C Grade
 - Max 1.0%, 150 ppm/°C – D Grade
- Low Output Noise . . . 20 μV_{RMS} (Typ)
- Wide Operating Current Range . . . 45 μA (Typ) to 12 mA
- Stable With All Capacitive Loads; No Output Capacitor Required
- Available in
 - Industrial Temperature: -40°C to 85°C
 - Extended Temperature: -40°C to 125°C

- Applications
 - Data-Acquisition Systems
 - Power Supplies and Power-Supply Monitors
 - Instrumentation and Test Equipment
 - Process Control
 - Precision Audio
 - Automotive Electronics
 - Energy Management/Metering
 - Battery-Powered Equipment

1.2 V . . . DBZ (SOT-23) PACKAGE
(TOP VIEW)

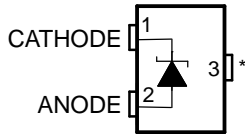

* Pin 3 must be connected to ANODE or left open.

1.2 V . . . DCK (SC-70) PACKAGE
(TOP VIEW)

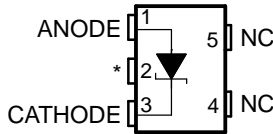

NC – No internal connection
* Pin 2 must be connected to ANODE or left open.

1.2 V . . . LP (TO-92/TO-226) PACKAGE
(TOP VIEW)



NC – No internal connection

Adjustable . . . DBZ (SOT-23) PACKAGE
(TOP VIEW)



Adjustable . . . DCK (SC-70) PACKAGE
(TOP VIEW)

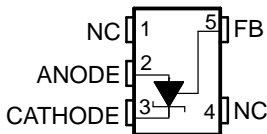

NC – No internal connection

Adjustable . . . LP (TO-92/TO-226) PACKAGE
(TOP VIEW)

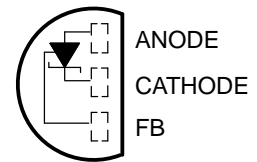

DESCRIPTION/ORDERING INFORMATION

The LM4041 series of shunt voltage references are versatile, easy-to-use references suitable for a wide array of applications. They require no external capacitors for operation and are stable with all capacitive loads. Additionally, the reference offers low dynamic impedance, low noise, and a low temperature coefficient to ensure a stable output voltage over a wide range of operating currents and temperatures. The LM4041 uses fuse and Zener-zap reverse breakdown voltage trim during wafer sort to offer four output voltage tolerances, ranging from 0.1% (max) for the A grade to 1% (max) for the D grade. Thus, a great deal of flexibility is offered to designers in choosing the best cost-to-performance ratio for their applications. The LM4041 is available in a fixed (1.225 V nominal) or an adjustable version (which requires an external resistor divider to set the output to a value between 1.225 V and 10 V).



Please be aware that an important notice concerning availability, standard warranty, and use in critical applications of Texas Instruments semiconductor products and disclaimers thereto appears at the end of this data sheet.

LM4041

PRECISION MICROPOWER SHUNT VOLTAGE REFERENCE

SLCS146E—FEBRUARY 2005—REVISED FEBRUARY 2006

Packaged in space-saving SC-70 and SOT-23-3 and requiring a minimum current of 45 μ A (typ), the LM4041 also is ideal for portable applications. The TO-92 package also is available for through-hole packaging needs. The LM4041xl is characterized for operation over an ambient temperature range of -40°C to 85°C . The LM4041xQ is characterized for operation over an ambient temperature range of -40°C to 125°C .

ORDERING INFORMATION

| T _A | DEVICE GRADE | V _Z | PACKAGE ⁽¹⁾ | | ORDERABLE PART NUMBER | TOP-SIDE MARKING ⁽²⁾ |
|---|---|-------------------|------------------------|----------------|-----------------------|---------------------------------|
| -40°C to 85°C | A grade: 0.1% initial accuracy and 100 ppm/ $^{\circ}\text{C}$ temperature coefficient | 1.2 V | SC-70 (DCK) | Reel of 3000 | LM4041A12IDCKR | MK_ |
| | | | | Reel of 250 | LM4041A12IDBZR | 4MK_ |
| | | | SOT-23-3 (DBZ) | Bulk of 1000 | LM4041A12ILP | PREVIEW |
| | | | | Reel of 2000 | LM4041A12ILPR | |
| | | | TO-92/TO-226 (LP) | Reel of 3000 | LM4041BIDCKR | MG_ |
| | | | | Reel of 250 | LM4041BIDCKT | |
| | B grade: 0.2% initial accuracy and 100 ppm/ $^{\circ}\text{C}$ temperature coefficient | ADJ | SC-70 (DCK) | Reel of 3000 | LM4041BIDBZR | 4MG_ |
| | | | | Reel of 250 | LM4041BIDBZT | |
| | | | SOT-23-3 (DBZ) | Bulk of 1000 | LM4041BILP | PREVIEW |
| | | | | Reel of 2000 | LM4041BILPR | |
| | | | TO-92/TO-226 (LP) | Reel of 3000 | LM4041B12IDCKR | ML_ |
| | | | | Reel of 250 | LM4041B12IDBZR | |
| | C grade: 0.5% initial accuracy and 100 ppm/ $^{\circ}\text{C}$ temperature coefficient | 1.2 V | SC-70 (DCK) | Reel of 3000 | LM4041B12IDBZT | 4ML_ |
| | | | | Reel of 250 | LM4041B12IDBZT | |
| | | | SOT-23-3 (DBZ) | Bulk of 1000 | LM4041B12ILP | PREVIEW |
| | | | | Reel of 2000 | LM4041B12ILPR | |
| | | | TO-92/TO-226 (LP) | Reel of 3000 | LM4041CIDCKR | MH_ |
| | | | | Reel of 250 | LM4041CIDCKT | |
| | D grade: 1.0% initial accuracy and 150 ppm/ $^{\circ}\text{C}$ temperature coefficient | ADJ | SC-70 (DCK) | Reel of 3000 | LM4041CIDBZR | 4MH_ |
| | | | | Reel of 250 | LM4041CIDBZT | |
| | | | SOT-23-3 (DBZ) | Bulk of 1000 | LM4041CILP | PREVIEW |
| | | | | Reel of 2000 | LM4041CILPR | |
| | | | TO-92/TO-226 (LP) | Reel of 3000 | LM4041C12IDCKR | MM_ |
| | | | | Reel of 250 | LM4041C12IDBZR | |
| D grade: 1.0% initial accuracy and 150 ppm/ $^{\circ}\text{C}$ temperature coefficient | 1.2 V | SC-70 (DCK) | Reel of 3000 | LM4041C12IDBZT | 4MM_ | |
| | | | Reel of 250 | LM4041C12IDBZT | | |
| | | SOT-23-3 (DBZ) | Bulk of 1000 | LM4041C12ILP | PREVIEW | |
| | | | Reel of 2000 | LM4041C12ILPR | | |
| | | TO-92/TO-226 (LP) | Reel of 3000 | LM4041DIDCKR | MJ_ | |
| | | | Reel of 250 | LM4041DIDCKT | | |
| D grade: 1.0% initial accuracy and 150 ppm/ $^{\circ}\text{C}$ temperature coefficient | ADJ | SC-70 (DCK) | Reel of 3000 | LM4041DIDBZR | 4MJ_ | |
| | | | Reel of 250 | LM4041DIDBZT | | |
| | | SOT-23-3 (DBZ) | Bulk of 1000 | LM4041DILP | PREVIEW | |
| | | | Reel of 2000 | LM4041DILPR | | |
| | | TO-92/TO-226 (LP) | Reel of 3000 | LM4041D12IDCKR | MN_ | |
| | | | Reel of 250 | LM4041D12IDBZR | | |
| D grade: 1.0% initial accuracy and 150 ppm/ $^{\circ}\text{C}$ temperature coefficient | 1.2 V | SC-70 (DCK) | Reel of 3000 | LM4041D12IDBZT | 4MN_ | |
| | | | Reel of 250 | LM4041D12IDBZT | | |
| | | SOT-23-3 (DBZ) | Bulk of 1000 | LM4041D12ILP | PREVIEW | |
| | | | Reel of 2000 | LM4041D12ILPR | | |
| | | TO-92/TO-226 (LP) | Reel of 3000 | LM4041D12IDCKR | MN_ | |
| | | | Reel of 250 | LM4041D12IDBZR | | |
| D grade: 1.0% initial accuracy and 150 ppm/ $^{\circ}\text{C}$ temperature coefficient | ADJ | SC-70 (DCK) | Reel of 3000 | LM4041D12IDBZT | 4MN_ | |
| | | | Reel of 250 | LM4041D12IDBZT | | |
| | | SOT-23-3 (DBZ) | Bulk of 1000 | LM4041D12ILP | PREVIEW | |
| | | | Reel of 2000 | LM4041D12ILPR | | |
| | | TO-92/TO-226 (LP) | Reel of 3000 | LM4041D12IDCKR | MN_ | |
| | | | Reel of 250 | LM4041D12IDBZR | | |
| D grade: 1.0% initial accuracy and 150 ppm/ $^{\circ}\text{C}$ temperature coefficient | 1.2 V | SC-70 (DCK) | Reel of 3000 | LM4041D12IDBZT | 4MN_ | |
| | | | Reel of 250 | LM4041D12IDBZT | | |
| | | SOT-23-3 (DBZ) | Bulk of 1000 | LM4041D12ILP | PREVIEW | |
| | | | Reel of 2000 | LM4041D12ILPR | | |
| | | TO-92/TO-226 (LP) | Reel of 3000 | LM4041D12IDCKR | MN_ | |
| | | | Reel of 250 | LM4041D12IDBZR | | |

(1) Package drawings, standard packing quantities, thermal data, symbolization, and PCB design guidelines are available at www.ti.com/sc/package.

(2) DBZ/DCK: The actual top-side marking has one additional character that designates the assembly/test site.

ORDERING INFORMATION

| T _A | DEVICE GRADE | V _Z | PACKAGE ⁽¹⁾ | | ORDERABLE PART NUMBER | TOP-SIDE MARKING ⁽²⁾ |
|----------------|---|----------------|------------------------|--------------|-----------------------|---------------------------------|
| -40°C to 125°C | C grade: 0.5% initial accuracy and 100 ppm/°C temperature coefficient | ADJ | SOT-23-3 (DBZ) | Reel of 3000 | LM4041CQDBZR | 4MP_ |
| | | | | Reel of 250 | LM4041CQDBZT | |
| | | 1.2 V | SOT-23-3 (DBZ) | Reel of 3000 | LM4041C12QDBZR | 4MS_ |
| | | | | Reel of 250 | LM4041C12QDBZT | |
| | D grade: 1.0% initial accuracy and 150 ppm/°C temperature coefficient | ADJ | SOT-23-3 (DBZ) | Reel of 3000 | LM4041DQDBZR | 4MR_ |
| | | | | Reel of 250 | LM4041DQDBZT | |
| | | 1.2 V | SOT-23-3 (DBZ) | Reel of 3000 | LM4041D12QDBZR | 4MT_ |
| | | | | Reel of 250 | LM4041D12QDBZT | |

(1) Package drawings, standard packing quantities, thermal data, symbolization, and PCB design guidelines are available at www.ti.com/sc/package.

(2) DBZ/DCK: The actual top-side marking has one additional character that designates the assembly/test site.

LM4041 PRECISION MICROPOWER SHUNT VOLTAGE REFERENCE

SLCS146E—FEBRUARY 2005—REVISED FEBRUARY 2006

FUNCTIONAL BLOCK DIAGRAM



- (1) LM4041x (ADJ) only
(2) LM4041x12 only

Absolute Maximum Ratings⁽¹⁾

over free-air temperature range (unless otherwise noted)

| | | MIN | MAX | UNIT |
|---------------|---|-------------|-----|------|
| V_Z | Continuous cathode voltage | | 15 | V |
| I_Z | Continuous cathode current | -10 | 25 | mA |
| θ_{JA} | Package thermal impedance ⁽²⁾⁽³⁾ | DBZ package | 206 | °C/W |
| | | DCK package | 252 | |
| | | LP package | 156 | |
| T_J | Operating virtual junction temperature | | 150 | °C |
| T_{stg} | Storage temperature range | -65 | 150 | °C |

- (1) Stresses beyond those listed under "absolute maximum ratings" may cause permanent damage to the device. These are stress ratings only, and functional operation of the device at these or any other conditions beyond those indicated under "recommended operating conditions" is not implied. Exposure to absolute-maximum-rated conditions for extended periods may affect device reliability.
(2) Maximum power dissipation is a function of $T_J(\max)$, θ_{JA} , and T_A . The maximum allowable power dissipation at any allowable ambient temperature is $P_D = (T_J(\max) - T_A)/\theta_{JA}$. Operating at the absolute maximum T_J of 150°C can affect reliability.
(3) The package thermal impedance is calculated in accordance with JESD 51-7.

Recommended Operating Conditions

| | | MIN | MAX | UNIT |
|-------|--|------------------------|-----|------|
| I_Z | Cathode current | (1) | 12 | mA |
| V_Z | Reverse breakdown voltage (adjustable version) | | 10 | V |
| T_A | Free-air temperature | LM4041 (I temperature) | -40 | °C |
| | | LM4041 (Q temperature) | -40 | |

- (1) See parametric tables

LM4041x12I Electrical Characteristics

full-range $T_A = -40^\circ\text{C}$ to 85°C (unless otherwise noted)

| PARAMETER | TEST CONDITIONS | T_A | LM4041A12I | | | LM4041B12I | | | UNIT | |
|-------------------------|--|--|--------------------|-----------|-----|------------|-----------|----------------------------|-----------------------|--|
| | | | MIN | TYP | MAX | MIN | TYP | MAX | | |
| V_Z | Reverse breakdown voltage | $I_Z = 100\ \mu\text{A}$ | 1.225 | | | 1.225 | | | V | |
| | Reverse breakdown voltage tolerance | 25°C | -1.2 | | 1.2 | -2.4 | | 2.4 | mV | |
| | | Full range | -9.2 | | 9.2 | -10.4 | | 10.4 | | |
| $I_{Z,\text{min}}$ | Minimum cathode current | 25°C | 45 | | 75 | 45 | | 75 | μA | |
| | | Full range | | | 80 | | | 80 | | |
| α_{VZ} | Average temperature coefficient of reverse breakdown voltage | $I_Z = 10\ \text{mA}$ | ± 20 | | | ± 20 | | | ppm/ $^\circ\text{C}$ | |
| | | $I_Z = 1\ \text{mA}$ | ± 15 | | | ± 15 | | | | |
| | | | Full range | ± 100 | | | ± 100 | | | |
| | | $I_Z = 100\ \mu\text{A}$ | ± 15 | | | ± 15 | | | | |
| $\Delta V_Z/\Delta I_Z$ | Reverse breakdown voltage change with cathode current change | $I_{Z,\text{min}} < I_Z < 1\ \text{mA}$ | 25°C | 0.7 | 1.5 | 0.7 | 1.5 | mV | | |
| | | | Full range | 2 | | 2 | | | | |
| | | $1\ \text{mA} < I_Z < 12\ \text{mA}$ | 25°C | 4 | | 6 | 4 | | 6 | |
| | | | Full range | | | 8 | | | 8 | |
| Z_Z | Reverse dynamic impedance | $I_Z = 1\ \text{mA}$, $f = 120\ \text{Hz}$, $I_{AC} = 0.1\ I_Z$ | 25°C | 0.5 | 1.5 | 0.5 | 1.5 | Ω | | |
| e_N | Wideband noise | $I_Z = 100\ \mu\text{A}$, $10\ \text{Hz} \leq f \leq 10\ \text{kHz}$ | 25°C | 20 | | 20 | | μV_{RMS} | | |
| | Long-term stability of reverse breakdown voltage | $t = 1000\ \text{h}$, $T_A = 25^\circ\text{C} \pm 0.1^\circ\text{C}$, $I_Z = 100\ \mu\text{A}$ | 25°C | 120 | | 120 | | ppm | | |

LM4041 PRECISION MICROPOWER SHUNT VOLTAGE REFERENCE

SLCS146E—FEBRUARY 2005—REVISED FEBRUARY 2006

LM4041x12I Electrical Characteristics

full-range $T_A = -40^\circ\text{C}$ to 85°C (unless otherwise noted)

| PARAMETER | TEST CONDITIONS | T_A | LM4041C12I | | | LM4041D12I | | | UNIT |
|-------------------------|--|--|------------|-----|-----|-----------------------------|-----|-----|----------------------------|
| | | | MIN | TYP | MAX | MIN | TYP | MAX | |
| V_Z | Reverse breakdown voltage | $I_Z = 100\ \mu\text{A}$ | 25°C | | | 1.225 | | | V |
| | Reverse breakdown voltage tolerance | $I_Z = 100\ \mu\text{A}$ | 25°C | | | -6 6 | | | mV |
| | | | Full range | | | -14 14 | | | |
| $I_{Z,\text{min}}$ | Minimum cathode current | | 25°C | | | 45 75 | | | μA |
| | | | Full range | | | 80 80 | | | |
| α_{VZ} | Average temperature coefficient of reverse breakdown voltage | $I_Z = 10\ \text{mA}$ | 25°C | | | ± 20 | | | ppm/°C |
| | | $I_Z = 1\ \text{mA}$ | 25°C | | | ± 15 | | | |
| | | | Full range | | | ± 100 ± 150 | | | |
| | | $I_Z = 100\ \mu\text{A}$ | 25°C | | | ± 15 | | | |
| $\Delta V_Z/\Delta I_Z$ | Reverse breakdown voltage change with cathode current change | $I_{Z,\text{min}} < I_Z < 1\ \text{mA}$ | 25°C | | | 0.7 1.5 | | | mV |
| | | | Full range | | | 2 2.5 | | | |
| | | $1\ \text{mA} < I_Z < 12\ \text{mA}$ | 25°C | | | 2.5 6 | | | |
| | | | Full range | | | 8 10 | | | |
| Z_Z | Reverse dynamic impedance | $I_Z = 1\ \text{mA}$, $f = 120\ \text{Hz}$, $I_{AC} = 0.1\ I_Z$ | 25°C | | | 0.5 1.5 | | | Ω |
| e_N | Wideband noise | $I_Z = 100\ \mu\text{A}$, $10\ \text{Hz} \leq f \leq 10\ \text{kHz}$ | 25°C | | | 20 | | | μV_{RMS} |
| | Long-term stability of reverse breakdown voltage | $t = 1000\ \text{h}$, $T_A = 25^\circ\text{C} \pm 0.1^\circ\text{C}$, $I_Z = 100\ \mu\text{A}$ | 25°C | | | 120 | | | ppm |

LM4041x12Q Electrical Characteristics

full-range $T_A = -40^\circ\text{C}$ to 125°C (unless otherwise noted)

| PARAMETER | TEST CONDITIONS | T_A | LM4041C12Q | | | LM4041D12Q | | | UNIT |
|-------------------------|--|--|------------|-----|-----|---------------------------------|-----|-----|----------------------------|
| | | | MIN | TYP | MAX | MIN | TYP | MAX | |
| V_Z | Reverse breakdown voltage | $I_Z = 100\ \mu\text{A}$ | 25°C | | | 1.225 | | | V |
| | Reverse breakdown voltage tolerance | $I_Z = 100\ \mu\text{A}$ | 25°C | | | -6 6 | | | mV |
| | | | Full range | | | -18.4 18.4 | | | |
| $I_{Z,\text{min}}$ | Minimum cathode current | | 25°C | | | 45 75 | | | μA |
| | | | Full range | | | 80 80 | | | |
| α_{VZ} | Average temperature coefficient of reverse breakdown voltage | $I_Z = 10\ \text{mA}$ | 25°C | | | ± 20 | | | ppm/°C |
| | | $I_Z = 1\ \text{mA}$ | 25°C | | | ± 15 | | | |
| | | | Full range | | | ± 100 | | | |
| | | $I_Z = 100\ \mu\text{A}$ | 25°C | | | ± 15 | | | |
| $\Delta V_Z/\Delta I_Z$ | Reverse breakdown voltage change with cathode current change | $I_{Z,\text{min}} < I_Z < 1\ \text{mA}$ | 25°C | | | 0.7 1.5 | | | mV |
| | | | Full range | | | 2 2.5 | | | |
| | | $1\ \text{mA} < I_Z < 12\ \text{mA}$ | 25°C | | | 2.5 6 | | | |
| | | | Full range | | | 8 10 | | | |
| Z_Z | Reverse dynamic impedance | $I_Z = 1\ \text{mA}$, $f = 120\ \text{Hz}$, $I_{AC} = 0.1 I_Z$ | 25°C | | | 0.5 0.5 | | | Ω |
| | | | Full range | | | 1.5 2 | | | |
| e_N | Wideband noise | $I_Z = 100\ \mu\text{A}$, $10\ \text{Hz} \leq f \leq 10\ \text{kHz}$ | 25°C | | | 20 20 | | | μV_{RMS} |
| | Long-term stability of reverse breakdown voltage | $t = 1000\ \text{h}$, $T_A = 25^\circ\text{C} \pm 0.1^\circ\text{C}$, $I_Z = 100\ \mu\text{A}$ | 25°C | | | 120 120 | | | ppm |

LM4041 PRECISION MICROPOWER SHUNT VOLTAGE REFERENCE

SLCS146E—FEBRUARY 2005—REVISED FEBRUARY 2006

LM4041xl (Adjustable Version) Electrical Characteristics

full-range $T_A = -40^\circ\text{C}$ to 85°C (unless otherwise noted)

| PARAMETER | TEST CONDITIONS | T_A | LM4041BI | | | LM4041CI | | | UNIT |
|--------------------------------|---|--|------------|-----|-----|-----------------|-----|-----|---------------------|
| | | | MIN | TYP | MAX | MIN | TYP | MAX | |
| V_{REF} | Reference voltage | $I_Z = 100\ \mu\text{A}$, $V_Z = 5\ \text{V}$ | 25°C | | | 1.233 | | | V |
| | Reference voltage tolerance ⁽¹⁾ | $I_Z = 100\ \mu\text{A}$, $V_Z = 5\ \text{V}$ | 25°C | | | -2.5 2.5 | | | mV |
| | | | Full range | | | -10.5 10.5 | | | |
| $I_{Z,min}$ | Minimum cathode current | | 25°C | | | 45 75 | | | μA |
| | | | Full range | | | 80 80 | | | |
| $\Delta V_{REF}/\Delta I_Z$ | Reference voltage change with cathode current change | $I_{Z,min} < I_Z < 1\ \text{mA}$ | 25°C | | | 0.7 1.5 | | | mV |
| | | | Full range | | | 2 2 | | | |
| | | $1\ \text{mA} < I_Z < 12\ \text{mA}$ | 25°C | | | 2 4 | | | |
| | | | Full range | | | 6 6 | | | |
| $\Delta V_{REF}/\Delta V_{KA}$ | Reference voltage change with output voltage change | $I_Z = 1\ \text{mA}$ | 25°C | | | -1.55 -2 | | | mV/V |
| | | | Full range | | | -2.5 -2.5 | | | |
| I_{FB} | Feedback current | | 25°C | | | 60 100 | | | nA |
| | | | Full range | | | 120 120 | | | |
| αV_{REF} | Average temperature coefficient of reference voltage ⁽¹⁾ | $I_Z = 10\ \text{mA}$, $V_Z = 5\ \text{V}$ | 25°C | | | ± 20 | | | ppm/°C |
| | | $I_Z = 1\ \text{mA}$, $V_Z = 5\ \text{V}$ | 25°C | | | ± 15 | | | |
| | | | Full range | | | ± 100 | | | |
| | | $I_Z = 100\ \mu\text{A}$, $V_Z = 5\ \text{V}$ | 25°C | | | ± 15 | | | |
| Z_Z | Reverse dynamic impedance | $I_Z = 1\ \text{mA}$, $f = 120\ \text{Hz}$, $I_{AC} = 0.1\ I_Z$, $V_Z = V_{REF}$ | 25°C | | | 0.3 | | | Ω |
| | | $I_Z = 1\ \text{mA}$, $f = 120\ \text{Hz}$, $I_{AC} = 0.1\ I_Z$, $V_Z = 10\ \text{V}$ | 25°C | | | 2 | | | |
| e_N | Wideband noise | $I_Z = 100\ \mu\text{A}$, $V_Z = V_{REF}$, $10\ \text{Hz} \leq f \leq 10\ \text{kHz}$ | 25°C | | | 20 | | | μV_{RMS} |
| | Long-term stability of reverse breakdown voltage | $t = 1000\ \text{h}$, $T_A = 25^\circ\text{C} \pm 0.1^\circ\text{C}$, $I_Z = 100\ \mu\text{A}$ | 25°C | | | 120 | | | ppm |

(1) Reference voltage tolerance and average temperature coefficient change with output voltage (V_Z). See *Typical Characteristics*.

LM4041xl (Adjustable Version) Electrical Characteristics

full-range $T_A = -40^\circ\text{C}$ to 85°C (unless otherwise noted)

| PARAMETER | TEST CONDITIONS | T_A | LM4041DI | | | UNIT |
|--------------------------------|---|--|--|-------|-----------|---------------------|
| | | | MIN | TYP | MAX | |
| V_{REF} | Reference voltage | $I_Z = 100\ \mu\text{A}$, $V_Z = 5\ \text{V}$ | 25°C | 1.233 | | V |
| | Reference voltage tolerance ⁽¹⁾ | $I_Z = 100\ \mu\text{A}$, $V_Z = 5\ \text{V}$ | 25°C | -12 | 12 | mV |
| | | | Full range | -24 | 24 | |
| $I_{Z,min}$ | Minimum cathode current | | 25°C | 45 | 75 | μA |
| | | | Full range | | 80 | |
| $\Delta V_{REF}/\Delta I_Z$ | Reference voltage change with cathode current change | $I_{Z,min} < I_Z < 1\ \text{mA}$ | 25°C | 0.7 | 2 | mV |
| | | | Full range | | 2.5 | |
| | | $1\ \text{mA} < I_Z < 12\ \text{mA}$ | 25°C | 2 | 6 | |
| | | | Full range | | 8 | |
| $\Delta V_{REF}/\Delta V_{KA}$ | Reference voltage change with output voltage change | $I_Z = 1\ \text{mA}$ | 25°C | -1.55 | -2 | mV/V |
| | | | Full range | | -3 | |
| I_{FB} | Feedback current | | 25°C | 60 | 150 | nA |
| | | | Full range | | 200 | |
| αV_{REF} | Average temperature coefficient of reference voltage ⁽¹⁾ | | $I_Z = 10\ \text{mA}$, $V_Z = 5\ \text{V}$ | 25°C | ± 20 | ppm/°C |
| | | | $I_Z = 1\ \text{mA}$, $V_Z = 5\ \text{V}$ | 25°C | ± 15 | |
| | | | Full range | | ± 150 | |
| | | | $I_Z = 100\ \mu\text{A}$, $V_Z = 5\ \text{V}$ | 25°C | ± 15 | |
| Z_Z | Reverse dynamic impedance | | $I_Z = 1\ \text{mA}$, $f = 120\ \text{Hz}$, $I_{AC} = 0.1\ I_Z$, $V_Z = V_{REF}$ | 25°C | 0.3 | Ω |
| | | | $I_Z = 1\ \text{mA}$, $f = 120\ \text{Hz}$, $I_{AC} = 0.1\ I_Z$, $V_Z = 10\ \text{V}$ | 25°C | 2 | |
| e_N | Wideband noise | $I_Z = 100\ \mu\text{A}$, $V_Z = V_{REF}$, $10\ \text{Hz} \leq f \leq 10\ \text{kHz}$ | 25°C | 20 | | μV_{RMS} |
| | Long-term stability of reverse breakdown voltage | $t = 1000\ \text{h}$, $T_A = 25^\circ\text{C} \pm 0.1^\circ\text{C}$, $I_Z = 100\ \mu\text{A}$ | 25°C | 120 | | ppm |

(1) Reference voltage tolerance and average temperature coefficient change with output voltage (V_Z). See *Typical Characteristics*.

LM4041 PRECISION MICROPOWER SHUNT VOLTAGE REFERENCE

SLCS146E—FEBRUARY 2005—REVISED FEBRUARY 2006

LM4041xQ (Adjustable Version) Electrical Characteristics

full-range $T_A = -40^\circ\text{C}$ to 125°C (unless otherwise noted)

| PARAMETER | TEST CONDITIONS | T_A | LM4041CQ | | | LM4041DQ | | | UNIT |
|--------------------------------|---|--|------------|-----------|-----|-----------|------|---------------------|------|
| | | | MIN | TYP | MAX | MIN | TYP | MAX | |
| V_{REF} | Reference voltage | $I_Z = 100\ \mu\text{A}$, $V_Z = 5\ \text{V}$ | 25°C | 1.233 | | 1.233 | | V | |
| | Reference voltage tolerance ⁽¹⁾ | $I_Z = 100\ \mu\text{A}$, $V_Z = 5\ \text{V}$ | 25°C | -6.2 | 6.2 | -12 | 12 | mV | |
| | | | Full range | -18 | 18 | -30 | 30 | | |
| $I_{Z,min}$ | Minimum cathode current | | 25°C | 45 | 75 | 45 | 75 | μA | |
| | | | Full range | | 80 | | 80 | | |
| $\Delta V_{REF}/\Delta I_Z$ | Reference voltage change with cathode current change | $I_{Z,min} < I_Z < 1\ \text{mA}$ | 25°C | 0.7 | 1.5 | 0.7 | 2 | mV | |
| | | | Full range | | 2 | | 2.5 | | |
| | | $1\ \text{mA} < I_Z < 12\ \text{mA}$ | 25°C | 2 | 4 | 2 | 6 | | |
| | | | Full range | | 8 | | 10 | | |
| $\Delta V_{REF}/\Delta V_{KA}$ | Reference voltage change with output voltage change | $I_Z = 1\ \text{mA}$ | 25°C | -1.55 | -2 | -1.55 | -2.5 | mV/V | |
| | | | Full range | | -3 | | -4 | | |
| I_{FB} | Feedback current | | 25°C | 60 | 100 | 60 | 150 | nA | |
| | | | Full range | | 120 | | 200 | | |
| αV_{REF} | Average temperature coefficient of reference voltage ⁽¹⁾ | $I_Z = 10\ \text{mA}$, $V_Z = 5\ \text{V}$ | 25°C | ± 20 | | ± 20 | | ppm/°C | |
| | | | 25°C | ± 15 | | ± 15 | | | |
| | | $I_Z = 1\ \text{mA}$, $V_Z = 5\ \text{V}$ | 25°C | ± 15 | | ± 15 | | | |
| | | | Full range | ± 100 | | ± 150 | | | |
| Z_Z | Reverse dynamic impedance | $I_Z = 1\ \text{mA}$, $f = 120\ \text{Hz}$, $I_{AC} = 0.1\ I_Z$, $V_Z = V_{REF}$ | 25°C | 0.3 | | 0.3 | | Ω | |
| | | | 25°C | 2 | | 2 | | | |
| e_N | Wideband noise | $I_Z = 100\ \mu\text{A}$, $V_Z = V_{REF}$, $10\ \text{Hz} \leq f \leq 10\ \text{kHz}$ | 25°C | 20 | | 20 | | μV_{RMS} | |
| | Long-term stability of reverse breakdown voltage | $t = 1000\ \text{h}$, $T_A = 25^\circ\text{C} \pm 0.1^\circ\text{C}$, $I_Z = 100\ \mu\text{A}$ | 25°C | 120 | | 120 | | ppm | |

(1) Reference voltage tolerance and average temperature coefficient change with output voltage (V_Z). See *Typical Characteristics*.

TYPICAL CHARACTERISTICS



Figure 1. Temperature Drift for Different Average Temperature Coefficients



Figure 2. Noise Voltage vs Frequency



Figure 3. Start-Up Characteristics



Figure 4. Reference Voltage vs Reverse (Output) Voltage (for Different Temperatures)

TYPICAL CHARACTERISTICS



Figure 5. Reference Voltage vs Temperature (for Different Reverse Voltages)



Figure 6. Feedback Current vs Reverse (Output) Voltage (for Different Temperatures)

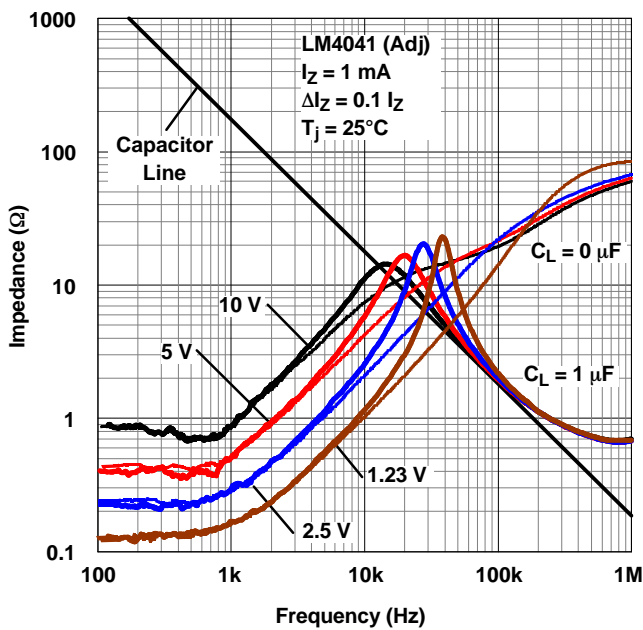

Figure 7. Output Impedance vs Frequency



Figure 8. Output Impedance vs Frequency

TYPICAL CHARACTERISTICS



Figure 9. Reverse Characteristics

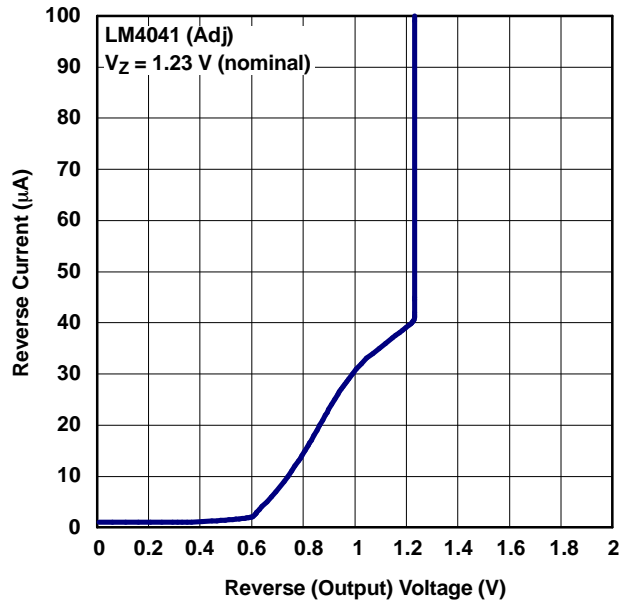

Figure 10. Reverse Characteristics and Minimum Operating Current

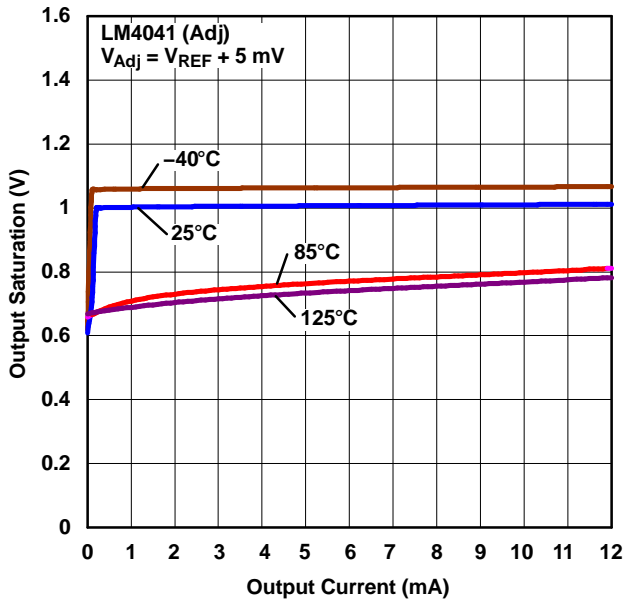

Figure 11. Output Saturation vs Output Current

APPLICATION INFORMATION



Figure 12. Startup Characteristics Test Circuit



Figure 13. Reverse Characteristics Test Circuit

Output Capacitor

The LM4041 does not require an output capacitor across CATHODE and ANODE for stability. However, if an output bypass capacitor is desired, the LM4041 is designed to be stable with all capacitive loads.

SOT-23 and SC-70 Pin Connections

There is a parasitic Schottky diode connected between pins 2 and 3 of the SOT-23 packaged device. Thus, pin 3 of the SOT-23 package must be left floating or connected to pin 2. Similarly, pin 2 of the SC-70 package also must be left floating or connected to pin 1.

APPLICATION INFORMATION

Adjustable Version

The adjustable version allows V_Z to be set by a user-defined resistor divider. The output voltage, V_Z , is set according to the equation shown in [Figure 14](#).

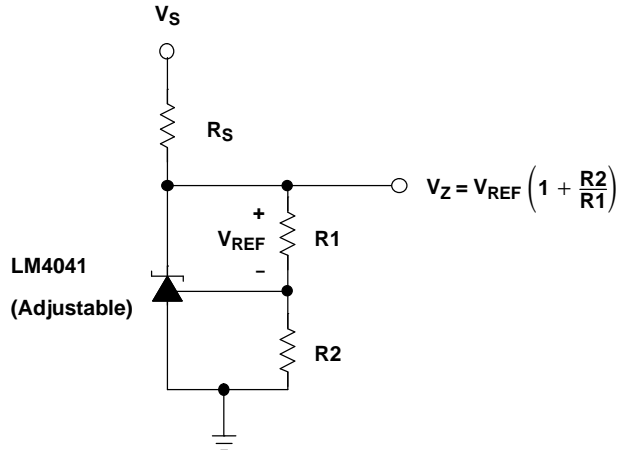

Figure 14. Adjustable Shunt Regulator

Cathode and Load Currents

In a typical shunt regulator configuration (see [Figure 15](#)), an external resistor, R_S , is connected between the supply and the cathode of the LM4041. R_S must be set properly, as it sets the total current available to supply the load (I_L) and bias the LM4041 (I_Z). In all cases, I_Z must stay within a specified range for proper operation of the reference. Taking into consideration one extreme in the variation of the load and supply voltage (maximum I_L and minimum V_S), R_S must be small enough to supply the minimum I_Z required for operation of the regulator, as given by data sheet parameters. At the other extreme, maximum V_S and minimum I_L , R_S must be large enough to limit I_Z to less than its maximum recommended rating of 12 mA.

R_S is calculated as shown in [Equation 1](#).

$$R_S = \frac{(V_S - V_Z)}{(I_L + I_Z)} \quad (1)$$



Figure 15. Shunt Regulator

PACKAGING INFORMATION

| Orderable Device | Status (1) | Package Type | Package Drawing | Pins | Package Qty | Eco Plan (2) | Lead/Ball Finish (6) | MSL Peak Temp (3) | Op Temp (°C) | Device Marking (4/5) | Samples |
|------------------|---------------|--------------|-----------------|------|-------------|-------------------------|-------------------------|----------------------|--------------|-------------------------|-------------------------|
| LM4041A12IDBZR | ACTIVE | SOT-23 | DBZ | 3 | 3000 | Green (RoHS & no Sb/Br) | CU NIPDAU | Level-1-260C-UNLIM | -40 to 85 | (4MK3, 4MKU) | Samples |
| LM4041A12IDBZRG4 | ACTIVE | SOT-23 | DBZ | 3 | 3000 | Green (RoHS & no Sb/Br) | CU NIPDAU | Level-1-260C-UNLIM | -40 to 85 | (4MK3, 4MKU) | Samples |
| LM4041A12IDBZT | ACTIVE | SOT-23 | DBZ | 3 | 250 | Green (RoHS & no Sb/Br) | CU NIPDAU | Level-1-260C-UNLIM | -40 to 85 | (4MK3, 4MKU) | Samples |
| LM4041A12IDCKR | ACTIVE | SC70 | DCK | 5 | 3000 | Green (RoHS & no Sb/Br) | CU NIPDAU | Level-1-260C-UNLIM | -40 to 85 | MKU | Samples |
| LM4041A12ILP | PREVIEW | TO-92 | LP | 3 | 1000 | TBD | Call TI | Call TI | -40 to 85 | | |
| LM4041B12IDBZR | ACTIVE | SOT-23 | DBZ | 3 | 3000 | Green (RoHS & no Sb/Br) | CU NIPDAU | Level-1-260C-UNLIM | -40 to 85 | (4ML3, 4MLU) | Samples |
| LM4041B12IDBZT | ACTIVE | SOT-23 | DBZ | 3 | 250 | Green (RoHS & no Sb/Br) | CU NIPDAU | Level-1-260C-UNLIM | -40 to 85 | (4ML3, 4MLU) | Samples |
| LM4041B12IDCKR | ACTIVE | SC70 | DCK | 5 | 3000 | Green (RoHS & no Sb/Br) | CU NIPDAU | Level-1-260C-UNLIM | -40 to 85 | MLU | Samples |
| LM4041B12ILP | PREVIEW | TO-92 | LP | 3 | 1000 | TBD | Call TI | Call TI | -40 to 85 | | |
| LM4041BIDBZR | ACTIVE | SOT-23 | DBZ | 3 | 3000 | Green (RoHS & no Sb/Br) | CU NIPDAU | Level-1-260C-UNLIM | -40 to 85 | (4MG3, 4MGU) | Samples |
| LM4041BIDBZRG4 | ACTIVE | SOT-23 | DBZ | 3 | 3000 | Green (RoHS & no Sb/Br) | CU NIPDAU | Level-1-260C-UNLIM | -40 to 85 | (4MG3, 4MGU) | Samples |
| LM4041BIDBZT | ACTIVE | SOT-23 | DBZ | 3 | 250 | Green (RoHS & no Sb/Br) | CU NIPDAU | Level-1-260C-UNLIM | -40 to 85 | (4MG3, 4MGU) | Samples |
| LM4041BIDBZTG4 | ACTIVE | SOT-23 | DBZ | 3 | 250 | Green (RoHS & no Sb/Br) | CU NIPDAU | Level-1-260C-UNLIM | -40 to 85 | (4MG3, 4MGU) | Samples |
| LM4041BIDCKR | ACTIVE | SC70 | DCK | 5 | 3000 | Green (RoHS & no Sb/Br) | CU NIPDAU | Level-1-260C-UNLIM | -40 to 85 | MGU | Samples |
| LM4041BIDCKT | ACTIVE | SC70 | DCK | 5 | 250 | Green (RoHS & no Sb/Br) | CU NIPDAU | Level-1-260C-UNLIM | -40 to 85 | MGU | Samples |
| LM4041BILP | PREVIEW | TO-92 | LP | 3 | 1000 | TBD | Call TI | Call TI | -40 to 85 | | |
| LM4041BILPR | PREVIEW | TO-92 | LP | 3 | 2000 | TBD | Call TI | Call TI | -40 to 85 | | |
| LM4041C12IDBZR | ACTIVE | SOT-23 | DBZ | 3 | 3000 | Green (RoHS & no Sb/Br) | CU NIPDAU | Level-1-260C-UNLIM | -40 to 85 | (4MM3, 4MMU) | Samples |
| LM4041C12IDBZRG4 | ACTIVE | SOT-23 | DBZ | 3 | 3000 | Green (RoHS & no Sb/Br) | CU NIPDAU | Level-1-260C-UNLIM | -40 to 85 | (4MM3, 4MMU) | Samples |

| Orderable Device | Status (1) | Package Type | Package Drawing | Pins | Package Qty | Eco Plan (2) | Lead/Ball Finish (6) | MSL Peak Temp (3) | Op Temp (°C) | Device Marking (4/5) | Samples |
|------------------|---------------|--------------|-----------------|------|-------------|-------------------------|-------------------------|----------------------|--------------|-------------------------|-------------------------|
| LM4041C12IDBZT | ACTIVE | SOT-23 | DBZ | 3 | 250 | Green (RoHS & no Sb/Br) | CU NIPDAU | Level-1-260C-UNLIM | -40 to 85 | (4MM3, 4MMU) | Samples |
| LM4041C12IDBZTG4 | ACTIVE | SOT-23 | DBZ | 3 | 250 | Green (RoHS & no Sb/Br) | CU NIPDAU | Level-1-260C-UNLIM | -40 to 85 | (4MM3, 4MMU) | Samples |
| LM4041C12IDCKR | ACTIVE | SC70 | DCK | 5 | 3000 | Green (RoHS & no Sb/Br) | CU NIPDAU | Level-1-260C-UNLIM | -40 to 85 | MMU | Samples |
| LM4041C12IDCKRE4 | ACTIVE | SC70 | DCK | 5 | 3000 | Green (RoHS & no Sb/Br) | CU NIPDAU | Level-1-260C-UNLIM | -40 to 85 | MMU | Samples |
| LM4041C12IDCKRG4 | ACTIVE | SC70 | DCK | 5 | 3000 | Green (RoHS & no Sb/Br) | CU NIPDAU | Level-1-260C-UNLIM | -40 to 85 | MMU | Samples |
| LM4041C12ILP | ACTIVE | TO-92 | LP | 3 | 1000 | Pb-Free (RoHS) | CU SN | N / A for Pkg Type | -40 to 85 | NPC12I | Samples |
| LM4041C12ILPR | ACTIVE | TO-92 | LP | 3 | 2000 | Pb-Free (RoHS) | CU SN | N / A for Pkg Type | -40 to 85 | NPC12I | Samples |
| LM4041C12QDBZR | ACTIVE | SOT-23 | DBZ | 3 | 3000 | Green (RoHS & no Sb/Br) | CU NIPDAU | Level-1-260C-UNLIM | -40 to 125 | (4MS3, 4MSU) | Samples |
| LM4041C12QDBZRG4 | ACTIVE | SOT-23 | DBZ | 3 | 3000 | Green (RoHS & no Sb/Br) | CU NIPDAU | Level-1-260C-UNLIM | -40 to 125 | (4MS3, 4MSU) | Samples |
| LM4041C12QDBZT | ACTIVE | SOT-23 | DBZ | 3 | 250 | Green (RoHS & no Sb/Br) | CU NIPDAU | Level-1-260C-UNLIM | -40 to 125 | (4MS3, 4MSU) | Samples |
| LM4041CIDBZR | ACTIVE | SOT-23 | DBZ | 3 | 3000 | Green (RoHS & no Sb/Br) | CU NIPDAU | Level-1-260C-UNLIM | -40 to 85 | (4MH3, 4MHU) | Samples |
| LM4041CIDBZRG4 | ACTIVE | SOT-23 | DBZ | 3 | 3000 | Green (RoHS & no Sb/Br) | CU NIPDAU | Level-1-260C-UNLIM | -40 to 85 | (4MH3, 4MHU) | Samples |
| LM4041CIDBZT | ACTIVE | SOT-23 | DBZ | 3 | 250 | Green (RoHS & no Sb/Br) | CU NIPDAU | Level-1-260C-UNLIM | -40 to 85 | (4MH3, 4MHU) | Samples |
| LM4041CIDBZTG4 | ACTIVE | SOT-23 | DBZ | 3 | 250 | Green (RoHS & no Sb/Br) | CU NIPDAU | Level-1-260C-UNLIM | -40 to 85 | (4MH3, 4MHU) | Samples |
| LM4041CIDCKR | ACTIVE | SC70 | DCK | 5 | 3000 | Green (RoHS & no Sb/Br) | CU NIPDAU | Level-1-260C-UNLIM | -40 to 85 | MHU | Samples |
| LM4041CIDCKT | ACTIVE | SC70 | DCK | 5 | 250 | Green (RoHS & no Sb/Br) | CU NIPDAU | Level-1-260C-UNLIM | -40 to 85 | MHU | Samples |
| LM4041CILP | ACTIVE | TO-92 | LP | 3 | 1000 | Pb-Free (RoHS) | CU SN | N / A for Pkg Type | -40 to 85 | NPCI | Samples |
| LM4041CILPE3 | ACTIVE | TO-92 | LP | 3 | 1000 | Pb-Free (RoHS) | CU SN | N / A for Pkg Type | -40 to 85 | NPCI | Samples |

| Orderable Device | Status (1) | Package Type | Package Drawing | Pins | Package Qty | Eco Plan (2) | Lead/Ball Finish (6) | MSL Peak Temp (3) | Op Temp (°C) | Device Marking (4/5) | Samples |
|------------------|---------------|--------------|-----------------|------|-------------|-------------------------|-------------------------|----------------------|--------------|-------------------------|-------------------------|
| LM4041CILPR | ACTIVE | TO-92 | LP | 3 | 2000 | Pb-Free (RoHS) | CU SN | N / A for Pkg Type | -40 to 85 | NPCI | Samples |
| LM4041CQDBZR | ACTIVE | SOT-23 | DBZ | 3 | 3000 | Green (RoHS & no Sb/Br) | CU NIPDAU | Level-1-260C-UNLIM | -40 to 125 | (4MP3, 4MPU) | Samples |
| LM4041CQDBZT | ACTIVE | SOT-23 | DBZ | 3 | 250 | Green (RoHS & no Sb/Br) | CU NIPDAU | Level-1-260C-UNLIM | -40 to 125 | (4MP3, 4MPU) | Samples |
| LM4041CQDBZTG4 | ACTIVE | SOT-23 | DBZ | 3 | 250 | Green (RoHS & no Sb/Br) | CU NIPDAU | Level-1-260C-UNLIM | -40 to 125 | (4MP3, 4MPU) | Samples |
| LM4041D12IDBZR | ACTIVE | SOT-23 | DBZ | 3 | 3000 | Green (RoHS & no Sb/Br) | CU NIPDAU | Level-1-260C-UNLIM | -40 to 85 | (4MN3, 4MNU) | Samples |
| LM4041D12IDBZRG4 | ACTIVE | SOT-23 | DBZ | 3 | 3000 | Green (RoHS & no Sb/Br) | CU NIPDAU | Level-1-260C-UNLIM | -40 to 85 | (4MN3, 4MNU) | Samples |
| LM4041D12IDBZT | ACTIVE | SOT-23 | DBZ | 3 | 250 | Green (RoHS & no Sb/Br) | CU NIPDAU | Level-1-260C-UNLIM | -40 to 85 | (4MN3, 4MNU) | Samples |
| LM4041D12IDBZTG4 | ACTIVE | SOT-23 | DBZ | 3 | 250 | Green (RoHS & no Sb/Br) | CU NIPDAU | Level-1-260C-UNLIM | -40 to 85 | (4MN3, 4MNU) | Samples |
| LM4041D12IDCKR | ACTIVE | SC70 | DCK | 5 | 3000 | Green (RoHS & no Sb/Br) | CU NIPDAU | Level-1-260C-UNLIM | -40 to 85 | MNU | Samples |
| LM4041D12ILP | ACTIVE | TO-92 | LP | 3 | 1000 | Pb-Free (RoHS) | CU SN | N / A for Pkg Type | -40 to 85 | NPD12I | Samples |
| LM4041D12ILPE3 | ACTIVE | TO-92 | LP | 3 | 1000 | Pb-Free (RoHS) | CU SN | N / A for Pkg Type | -40 to 85 | NPD12I | Samples |
| LM4041D12ILPR | ACTIVE | TO-92 | LP | 3 | 2000 | Pb-Free (RoHS) | CU SN | N / A for Pkg Type | -40 to 85 | NPD12I | Samples |
| LM4041D12QDBZR | ACTIVE | SOT-23 | DBZ | 3 | 3000 | Green (RoHS & no Sb/Br) | CU NIPDAU | Level-1-260C-UNLIM | -40 to 125 | (4MT3, 4MTU) | Samples |
| LM4041DIDBZR | ACTIVE | SOT-23 | DBZ | 3 | 3000 | Green (RoHS & no Sb/Br) | CU NIPDAU | Level-1-260C-UNLIM | -40 to 85 | (4MJ3, 4MJU) | Samples |
| LM4041DIDBZRG4 | ACTIVE | SOT-23 | DBZ | 3 | 3000 | Green (RoHS & no Sb/Br) | CU NIPDAU | Level-1-260C-UNLIM | -40 to 85 | (4MJ3, 4MJU) | Samples |
| LM4041DIDBZT | ACTIVE | SOT-23 | DBZ | 3 | 250 | Green (RoHS & no Sb/Br) | CU NIPDAU | Level-1-260C-UNLIM | -40 to 85 | (4MJ3, 4MJU) | Samples |
| LM4041DIDBZTG4 | ACTIVE | SOT-23 | DBZ | 3 | 250 | Green (RoHS & no Sb/Br) | CU NIPDAU | Level-1-260C-UNLIM | -40 to 85 | (4MJ3, 4MJU) | Samples |
| LM4041DIDCKR | ACTIVE | SC70 | DCK | 5 | 3000 | Green (RoHS & no Sb/Br) | CU NIPDAU | Level-1-260C-UNLIM | -40 to 85 | MJU | Samples |

| Orderable Device | Status (1) | Package Type | Package Drawing | Pins | Package Qty | Eco Plan (2) | Lead/Ball Finish (6) | MSL Peak Temp (3) | Op Temp (°C) | Device Marking (4/5) | Samples |
|------------------|---------------|--------------|-----------------|------|-------------|-------------------------|-------------------------|----------------------|--------------|-------------------------|-------------------------|
| LM4041DIDCKT | ACTIVE | SC70 | DCK | 5 | 250 | Green (RoHS & no Sb/Br) | CU NIPDAU | Level-1-260C-UNLIM | -40 to 85 | MJU | Samples |
| LM4041DILP | ACTIVE | TO-92 | LP | 3 | 1000 | Pb-Free (RoHS) | CU SN | N / A for Pkg Type | -40 to 85 | NPDI | Samples |
| LM4041DILPR | ACTIVE | TO-92 | LP | 3 | 2000 | Pb-Free (RoHS) | CU SN | N / A for Pkg Type | -40 to 85 | NPDI | Samples |
| LM4041DQDBZR | ACTIVE | SOT-23 | DBZ | 3 | 3000 | Green (RoHS & no Sb/Br) | CU NIPDAU | Level-1-260C-UNLIM | -40 to 125 | (4MR3, 4MRU) | Samples |
| LM4041DQDBZRG4 | ACTIVE | SOT-23 | DBZ | 3 | 3000 | Green (RoHS & no Sb/Br) | CU NIPDAU | Level-1-260C-UNLIM | -40 to 125 | (4MR3, 4MRU) | Samples |
| LM4041DQDBZT | ACTIVE | SOT-23 | DBZ | 3 | 250 | Green (RoHS & no Sb/Br) | CU NIPDAU | Level-1-260C-UNLIM | -40 to 125 | (4MR3, 4MRU) | Samples |
| LM4041DQDBZTG4 | ACTIVE | SOT-23 | DBZ | 3 | 250 | Green (RoHS & no Sb/Br) | CU NIPDAU | Level-1-260C-UNLIM | -40 to 125 | (4MR3, 4MRU) | Samples |

(1) The marketing status values are defined as follows:

ACTIVE: Product device recommended for new designs.

LIFEBUY: TI has announced that the device will be discontinued, and a lifetime-buy period is in effect.

NRND: Not recommended for new designs. Device is in production to support existing customers, but TI does not recommend using this part in a new design.

PREVIEW: Device has been announced but is not in production. Samples may or may not be available.

OBSOLETE: TI has discontinued the production of the device.

(2) **RoHS:** TI defines "RoHS" to mean semiconductor products that are compliant with the current EU RoHS requirements for all 10 RoHS substances, including the requirement that RoHS substance do not exceed 0.1% by weight in homogeneous materials. Where designed to be soldered at high temperatures, "RoHS" products are suitable for use in specified lead-free processes. TI may reference these types of products as "Pb-Free".

RoHS Exempt: TI defines "RoHS Exempt" to mean products that contain lead but are compliant with EU RoHS pursuant to a specific EU RoHS exemption.

Green: TI defines "Green" to mean the content of Chlorine (Cl) and Bromine (Br) based flame retardants meet JS709B low halogen requirements of <=1000ppm threshold. Antimony trioxide based flame retardants must also meet the <=1000ppm threshold requirement.

(3) MSL, Peak Temp. - The Moisture Sensitivity Level rating according to the JEDEC industry standard classifications, and peak solder temperature.

(4) There may be additional marking, which relates to the logo, the lot trace code information, or the environmental category on the device.

(5) Multiple Device Markings will be inside parentheses. Only one Device Marking contained in parentheses and separated by a "~" will appear on a device. If a line is indented then it is a continuation of the previous line and the two combined represent the entire Device Marking for that device.

⁽⁶⁾ Lead/Ball Finish - Orderable Devices may have multiple material finish options. Finish options are separated by a vertical ruled line. Lead/Ball Finish values may wrap to two lines if the finish value exceeds the maximum column width.

Important Information and Disclaimer:The information provided on this page represents TI's knowledge and belief as of the date that it is provided. TI bases its knowledge and belief on information provided by third parties, and makes no representation or warranty as to the accuracy of such information. Efforts are underway to better integrate information from third parties. TI has taken and continues to take reasonable steps to provide representative and accurate information but may not have conducted destructive testing or chemical analysis on incoming materials and chemicals. TI and TI suppliers consider certain information to be proprietary, and thus CAS numbers and other limited information may not be available for release.

In no event shall TI's liability arising out of such information exceed the total purchase price of the TI part(s) at issue in this document sold by TI to Customer on an annual basis.

TAPE AND REEL INFORMATION

QUADRANT ASSIGNMENTS FOR PIN 1 ORIENTATION IN TAPE

*All dimensions are nominal

| Device | Package Type | Package Drawing | Pins | SPQ | Reel Diameter (mm) | Reel Width W1 (mm) | A0 (mm) | B0 (mm) | K0 (mm) | P1 (mm) | W (mm) | Pin1 Quadrant |
|----------------|--------------|-----------------|------|------|--------------------|--------------------|---------|---------|---------|---------|--------|---------------|
| LM4041A12IDBZR | SOT-23 | DBZ | 3 | 3000 | 178.0 | 9.2 | 3.15 | 2.77 | 1.22 | 4.0 | 8.0 | Q3 |
| LM4041A12IDBZT | SOT-23 | DBZ | 3 | 250 | 178.0 | 9.2 | 3.15 | 2.77 | 1.22 | 4.0 | 8.0 | Q3 |
| LM4041A12IDCKR | SC70 | DCK | 5 | 3000 | 179.0 | 8.4 | 2.2 | 2.5 | 1.2 | 4.0 | 8.0 | Q3 |
| LM4041B12IDBZR | SOT-23 | DBZ | 3 | 3000 | 178.0 | 9.2 | 3.15 | 2.77 | 1.22 | 4.0 | 8.0 | Q3 |
| LM4041B12IDBZT | SOT-23 | DBZ | 3 | 250 | 178.0 | 9.2 | 3.15 | 2.77 | 1.22 | 4.0 | 8.0 | Q3 |
| LM4041B12IDCKR | SC70 | DCK | 5 | 3000 | 179.0 | 8.4 | 2.2 | 2.5 | 1.2 | 4.0 | 8.0 | Q3 |
| LM4041BIDBZR | SOT-23 | DBZ | 3 | 3000 | 178.0 | 9.2 | 3.15 | 2.77 | 1.22 | 4.0 | 8.0 | Q3 |
| LM4041BIDBZT | SOT-23 | DBZ | 3 | 250 | 178.0 | 9.2 | 3.15 | 2.77 | 1.22 | 4.0 | 8.0 | Q3 |
| LM4041BIDCKR | SC70 | DCK | 5 | 3000 | 179.0 | 8.4 | 2.2 | 2.5 | 1.2 | 4.0 | 8.0 | Q3 |
| LM4041BIDCKT | SC70 | DCK | 5 | 250 | 179.0 | 8.4 | 2.2 | 2.5 | 1.2 | 4.0 | 8.0 | Q3 |
| LM4041C12IDBZR | SOT-23 | DBZ | 3 | 3000 | 178.0 | 9.2 | 3.15 | 2.77 | 1.22 | 4.0 | 8.0 | Q3 |
| LM4041C12IDBZT | SOT-23 | DBZ | 3 | 250 | 178.0 | 9.2 | 3.15 | 2.77 | 1.22 | 4.0 | 8.0 | Q3 |
| LM4041C12IDCKR | SC70 | DCK | 5 | 3000 | 179.0 | 8.4 | 2.2 | 2.5 | 1.2 | 4.0 | 8.0 | Q3 |
| LM4041C12QDBZR | SOT-23 | DBZ | 3 | 3000 | 178.0 | 9.2 | 3.15 | 2.77 | 1.22 | 4.0 | 8.0 | Q3 |
| LM4041C12QDBZR | SOT-23 | DBZ | 3 | 3000 | 179.0 | 8.4 | 3.15 | 2.95 | 1.22 | 4.0 | 8.0 | Q3 |
| LM4041C12QDBZT | SOT-23 | DBZ | 3 | 250 | 179.0 | 8.4 | 3.15 | 2.95 | 1.22 | 4.0 | 8.0 | Q3 |
| LM4041C12QDBZT | SOT-23 | DBZ | 3 | 250 | 178.0 | 9.2 | 3.15 | 2.77 | 1.22 | 4.0 | 8.0 | Q3 |
| LM4041CIDBZR | SOT-23 | DBZ | 3 | 3000 | 178.0 | 9.2 | 3.15 | 2.77 | 1.22 | 4.0 | 8.0 | Q3 |

| Device | Package Type | Package Drawing | Pins | SPQ | Reel Diameter (mm) | Reel Width W1 (mm) | A0 (mm) | B0 (mm) | K0 (mm) | P1 (mm) | W (mm) | Pin1 Quadrant |
|----------------|--------------|-----------------|------|------|--------------------|--------------------|---------|---------|---------|---------|--------|---------------|
| LM4041CIDBZT | SOT-23 | DBZ | 3 | 250 | 178.0 | 9.2 | 3.15 | 2.77 | 1.22 | 4.0 | 8.0 | Q3 |
| LM4041CIDCKR | SC70 | DCK | 5 | 3000 | 179.0 | 8.4 | 2.2 | 2.5 | 1.2 | 4.0 | 8.0 | Q3 |
| LM4041CIDCKT | SC70 | DCK | 5 | 250 | 179.0 | 8.4 | 2.2 | 2.5 | 1.2 | 4.0 | 8.0 | Q3 |
| LM4041CQDBZR | SOT-23 | DBZ | 3 | 3000 | 179.0 | 8.4 | 3.15 | 2.95 | 1.22 | 4.0 | 8.0 | Q3 |
| LM4041CQDBZR | SOT-23 | DBZ | 3 | 3000 | 178.0 | 9.2 | 3.15 | 2.77 | 1.22 | 4.0 | 8.0 | Q3 |
| LM4041CQDBZT | SOT-23 | DBZ | 3 | 250 | 179.0 | 8.4 | 3.15 | 2.95 | 1.22 | 4.0 | 8.0 | Q3 |
| LM4041CQDBZT | SOT-23 | DBZ | 3 | 250 | 178.0 | 9.2 | 3.15 | 2.77 | 1.22 | 4.0 | 8.0 | Q3 |
| LM4041D12IDBZR | SOT-23 | DBZ | 3 | 3000 | 178.0 | 9.2 | 3.15 | 2.77 | 1.22 | 4.0 | 8.0 | Q3 |
| LM4041D12IDBZT | SOT-23 | DBZ | 3 | 250 | 178.0 | 9.2 | 3.15 | 2.77 | 1.22 | 4.0 | 8.0 | Q3 |
| LM4041D12IDCKR | SC70 | DCK | 5 | 3000 | 179.0 | 8.4 | 2.2 | 2.5 | 1.2 | 4.0 | 8.0 | Q3 |
| LM4041D12QDBZR | SOT-23 | DBZ | 3 | 3000 | 178.0 | 9.2 | 3.15 | 2.77 | 1.22 | 4.0 | 8.0 | Q3 |
| LM4041D12QDBZR | SOT-23 | DBZ | 3 | 3000 | 179.0 | 8.4 | 3.15 | 2.95 | 1.22 | 4.0 | 8.0 | Q3 |
| LM4041DIDBZR | SOT-23 | DBZ | 3 | 3000 | 178.0 | 9.2 | 3.15 | 2.77 | 1.22 | 4.0 | 8.0 | Q3 |
| LM4041DIDBZT | SOT-23 | DBZ | 3 | 250 | 178.0 | 9.2 | 3.15 | 2.77 | 1.22 | 4.0 | 8.0 | Q3 |
| LM4041DIDCKR | SC70 | DCK | 5 | 3000 | 179.0 | 8.4 | 2.2 | 2.5 | 1.2 | 4.0 | 8.0 | Q3 |
| LM4041DIDCKT | SC70 | DCK | 5 | 250 | 179.0 | 8.4 | 2.2 | 2.5 | 1.2 | 4.0 | 8.0 | Q3 |
| LM4041DQDBZR | SOT-23 | DBZ | 3 | 3000 | 179.0 | 8.4 | 3.15 | 2.95 | 1.22 | 4.0 | 8.0 | Q3 |
| LM4041DQDBZR | SOT-23 | DBZ | 3 | 3000 | 178.0 | 9.2 | 3.15 | 2.77 | 1.22 | 4.0 | 8.0 | Q3 |
| LM4041DQDBZT | SOT-23 | DBZ | 3 | 250 | 178.0 | 9.2 | 3.15 | 2.77 | 1.22 | 4.0 | 8.0 | Q3 |
| LM4041DQDBZT | SOT-23 | DBZ | 3 | 250 | 179.0 | 8.4 | 3.15 | 2.95 | 1.22 | 4.0 | 8.0 | Q3 |

TAPE AND REEL BOX DIMENSIONS

*All dimensions are nominal

| Device | Package Type | Package Drawing | Pins | SPQ | Length (mm) | Width (mm) | Height (mm) |
|----------------|--------------|-----------------|------|------|-------------|------------|-------------|
| LM4041A12IDBZR | SOT-23 | DBZ | 3 | 3000 | 180.0 | 180.0 | 18.0 |
| LM4041A12IDBZT | SOT-23 | DBZ | 3 | 250 | 180.0 | 180.0 | 18.0 |
| LM4041A12IDCKR | SC70 | DCK | 5 | 3000 | 203.0 | 203.0 | 35.0 |
| LM4041B12IDBZR | SOT-23 | DBZ | 3 | 3000 | 180.0 | 180.0 | 18.0 |
| LM4041B12IDBZT | SOT-23 | DBZ | 3 | 250 | 180.0 | 180.0 | 18.0 |
| LM4041B12IDCKR | SC70 | DCK | 5 | 3000 | 203.0 | 203.0 | 35.0 |
| LM4041BIDBZR | SOT-23 | DBZ | 3 | 3000 | 180.0 | 180.0 | 18.0 |
| LM4041BIDBZT | SOT-23 | DBZ | 3 | 250 | 180.0 | 180.0 | 18.0 |
| LM4041BIDCKR | SC70 | DCK | 5 | 3000 | 203.0 | 203.0 | 35.0 |
| LM4041BIDCKT | SC70 | DCK | 5 | 250 | 203.0 | 203.0 | 35.0 |
| LM4041C12IDBZR | SOT-23 | DBZ | 3 | 3000 | 180.0 | 180.0 | 18.0 |
| LM4041C12IDBZT | SOT-23 | DBZ | 3 | 250 | 180.0 | 180.0 | 18.0 |
| LM4041C12IDCKR | SC70 | DCK | 5 | 3000 | 203.0 | 203.0 | 35.0 |
| LM4041C12QDBZR | SOT-23 | DBZ | 3 | 3000 | 180.0 | 180.0 | 18.0 |
| LM4041C12QDBZR | SOT-23 | DBZ | 3 | 3000 | 203.0 | 203.0 | 35.0 |
| LM4041C12QDBZT | SOT-23 | DBZ | 3 | 250 | 203.0 | 203.0 | 35.0 |
| LM4041C12QDBZT | SOT-23 | DBZ | 3 | 250 | 180.0 | 180.0 | 18.0 |
| LM4041CIDBZR | SOT-23 | DBZ | 3 | 3000 | 180.0 | 180.0 | 18.0 |
| LM4041CIDBZT | SOT-23 | DBZ | 3 | 250 | 180.0 | 180.0 | 18.0 |
| LM4041CIDCKR | SC70 | DCK | 5 | 3000 | 203.0 | 203.0 | 35.0 |
| LM4041CIDCKT | SC70 | DCK | 5 | 250 | 203.0 | 203.0 | 35.0 |
| LM4041CQDBZR | SOT-23 | DBZ | 3 | 3000 | 203.0 | 203.0 | 35.0 |
| LM4041CQDBZR | SOT-23 | DBZ | 3 | 3000 | 180.0 | 180.0 | 18.0 |
| LM4041CQDBZT | SOT-23 | DBZ | 3 | 250 | 203.0 | 203.0 | 35.0 |
| LM4041CQDBZT | SOT-23 | DBZ | 3 | 250 | 180.0 | 180.0 | 18.0 |
| LM4041D12IDBZR | SOT-23 | DBZ | 3 | 3000 | 180.0 | 180.0 | 18.0 |
| LM4041D12IDBZT | SOT-23 | DBZ | 3 | 250 | 180.0 | 180.0 | 18.0 |
| LM4041D12IDCKR | SC70 | DCK | 5 | 3000 | 203.0 | 203.0 | 35.0 |
| LM4041D12QDBZR | SOT-23 | DBZ | 3 | 3000 | 180.0 | 180.0 | 18.0 |
| LM4041D12QDBZR | SOT-23 | DBZ | 3 | 3000 | 203.0 | 203.0 | 35.0 |
| LM4041DIDBZR | SOT-23 | DBZ | 3 | 3000 | 180.0 | 180.0 | 18.0 |
| LM4041DIDBZT | SOT-23 | DBZ | 3 | 250 | 180.0 | 180.0 | 18.0 |
| LM4041DIDCKR | SC70 | DCK | 5 | 3000 | 203.0 | 203.0 | 35.0 |
| LM4041DIDCKT | SC70 | DCK | 5 | 250 | 203.0 | 203.0 | 35.0 |
| LM4041DQDBZR | SOT-23 | DBZ | 3 | 3000 | 203.0 | 203.0 | 35.0 |
| LM4041DQDBZR | SOT-23 | DBZ | 3 | 3000 | 180.0 | 180.0 | 18.0 |
| LM4041DQDBZT | SOT-23 | DBZ | 3 | 250 | 180.0 | 180.0 | 18.0 |
| LM4041DQDBZT | SOT-23 | DBZ | 3 | 250 | 203.0 | 203.0 | 35.0 |

DCK (R-PDSO-G5)

PLASTIC SMALL-OUTLINE PACKAGE



- NOTES:
- A. All linear dimensions are in millimeters.
 - B. This drawing is subject to change without notice.
 - C. Body dimensions do not include mold flash or protrusion. Mold flash and protrusion shall not exceed 0.15 per side.
 - D. Falls within JEDEC MO-203 variation AA.

DCK (R-PDSO-G5)

PLASTIC SMALL OUTLINE



- NOTES:
- All linear dimensions are in millimeters.
 - This drawing is subject to change without notice.
 - Customers should place a note on the circuit board fabrication drawing not to alter the center solder mask defined pad.
 - Publication IPC-7351 is recommended for alternate designs.
 - Laser cutting apertures with trapezoidal walls and also rounding corners will offer better paste release. Customers should contact their board assembly site for stencil design recommendations. Example stencil design based on a 50% volumetric metal load solder paste. Refer to IPC-7525 for other stencil recommendations.

GENERIC PACKAGE VIEW

DBZ 3

SOT-23 - 1.12 mm max height

SMALL OUTLINE TRANSISTOR



Images above are just a representation of the package family, actual package may vary.
Refer to the product data sheet for package details.

4203227/C

EXAMPLE BOARD LAYOUT

DBZ0003A

SOT-23 - 1.12 mm max height

SMALL OUTLINE TRANSISTOR



LAND PATTERN EXAMPLE
SCALE:15X



SOLDER MASK DETAILS

4214838/C 04/2017

NOTES: (continued)

4. Publication IPC-7351 may have alternate designs.
5. Solder mask tolerances between and around signal pads can vary based on board fabrication site.

EXAMPLE STENCIL DESIGN

DBZ0003A

SOT-23 - 1.12 mm max height

SMALL OUTLINE TRANSISTOR



SOLDER PASTE EXAMPLE
BASED ON 0.125 THICK STENCIL
SCALE:15X

4214838/C 04/2017

NOTES: (continued)

6. Laser cutting apertures with trapezoidal walls and rounded corners may offer better paste release. IPC-7525 may have alternate design recommendations.
7. Board assembly site may have different recommendations for stencil design.



Images above are just a representation of the package family, actual package may vary.
Refer to the product data sheet for package details.

LP0003A



PACKAGE OUTLINE

TO-92 - 5.34 mm max height

TO-92



4215214/B 04/2017

NOTES:

1. All linear dimensions are in millimeters. Any dimensions in parenthesis are for reference only. Dimensioning and tolerancing per ASME Y14.5M.
2. This drawing is subject to change without notice.
3. Lead dimensions are not controlled within this area.
4. Reference JEDEC TO-226, variation AA.
5. Shipping method:
 - a. Straight lead option available in bulk pack only.
 - b. Formed lead option available in tape and reel or ammo pack.
 - c. Specific products can be offered in limited combinations of shipping medium and lead options.
 - d. Consult product folder for more information on available options.

TAPE SPECIFICATIONS

LP0003A

TO-92 - 5.34 mm max height

TO-92

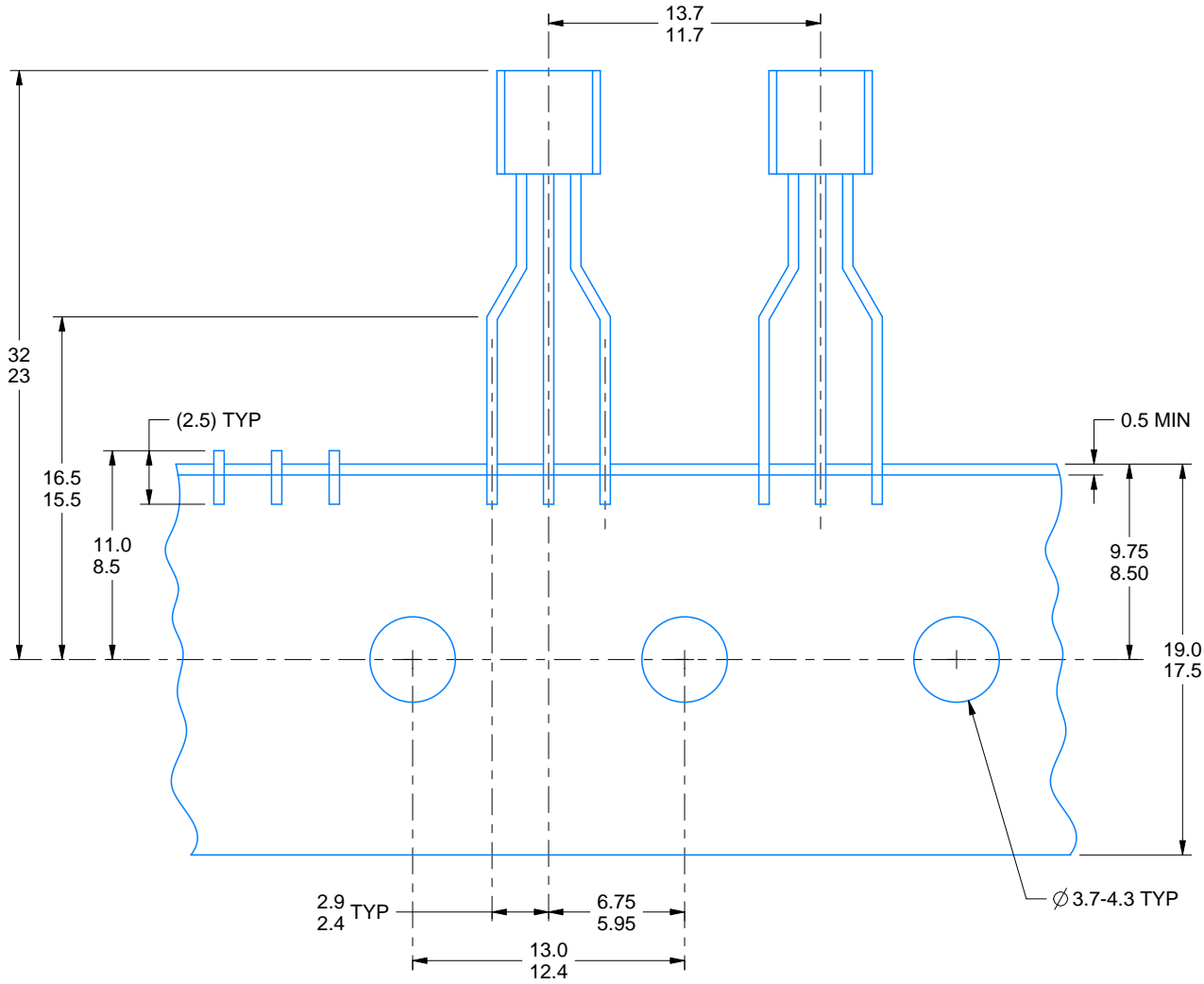

FOR FORMED LEAD OPTION PACKAGE

4215214/B 04/2017

IMPORTANT NOTICE

Texas Instruments Incorporated (TI) reserves the right to make corrections, enhancements, improvements and other changes to its semiconductor products and services per JESD46, latest issue, and to discontinue any product or service per JESD48, latest issue. Buyers should obtain the latest relevant information before placing orders and should verify that such information is current and complete.

TI's published terms of sale for semiconductor products (<http://www.ti.com/sc/docs/stdterms.htm>) apply to the sale of packaged integrated circuit products that TI has qualified and released to market. Additional terms may apply to the use or sale of other types of TI products and services.

Reproduction of significant portions of TI information in TI data sheets is permissible only if reproduction is without alteration and is accompanied by all associated warranties, conditions, limitations, and notices. TI is not responsible or liable for such reproduced documentation. Information of third parties may be subject to additional restrictions. Resale of TI products or services with statements different from or beyond the parameters stated by TI for that product or service voids all express and any implied warranties for the associated TI product or service and is an unfair and deceptive business practice. TI is not responsible or liable for any such statements.

Buyers and others who are developing systems that incorporate TI products (collectively, "Designers") understand and agree that Designers remain responsible for using their independent analysis, evaluation and judgment in designing their applications and that Designers have full and exclusive responsibility to assure the safety of Designers' applications and compliance of their applications (and of all TI products used in or for Designers' applications) with all applicable regulations, laws and other applicable requirements. Designer represents that, with respect to their applications, Designer has all the necessary expertise to create and implement safeguards that (1) anticipate dangerous consequences of failures, (2) monitor failures and their consequences, and (3) lessen the likelihood of failures that might cause harm and take appropriate actions. Designer agrees that prior to using or distributing any applications that include TI products, Designer will thoroughly test such applications and the functionality of such TI products as used in such applications.

TI's provision of technical, application or other design advice, quality characterization, reliability data or other services or information, including, but not limited to, reference designs and materials relating to evaluation modules, (collectively, "TI Resources") are intended to assist designers who are developing applications that incorporate TI products; by downloading, accessing or using TI Resources in any way, Designer (individually or, if Designer is acting on behalf of a company, Designer's company) agrees to use any particular TI Resource solely for this purpose and subject to the terms of this Notice.

TI's provision of TI Resources does not expand or otherwise alter TI's applicable published warranties or warranty disclaimers for TI products, and no additional obligations or liabilities arise from TI providing such TI Resources. TI reserves the right to make corrections, enhancements, improvements and other changes to its TI Resources. TI has not conducted any testing other than that specifically described in the published documentation for a particular TI Resource.

Designer is authorized to use, copy and modify any individual TI Resource only in connection with the development of applications that include the TI product(s) identified in such TI Resource. NO OTHER LICENSE, EXPRESS OR IMPLIED, BY ESTOPPEL OR OTHERWISE TO ANY OTHER TI INTELLECTUAL PROPERTY RIGHT, AND NO LICENSE TO ANY TECHNOLOGY OR INTELLECTUAL PROPERTY RIGHT OF TI OR ANY THIRD PARTY IS GRANTED HEREIN, including but not limited to any patent right, copyright, mask work right, or other intellectual property right relating to any combination, machine, or process in which TI products or services are used. Information regarding or referencing third-party products or services does not constitute a license to use such products or services, or a warranty or endorsement thereof. Use of TI Resources may require a license from a third party under the patents or other intellectual property of the third party, or a license from TI under the patents or other intellectual property of TI.

TI RESOURCES ARE PROVIDED "AS IS" AND WITH ALL FAULTS. TI DISCLAIMS ALL OTHER WARRANTIES OR REPRESENTATIONS, EXPRESS OR IMPLIED, REGARDING RESOURCES OR USE THEREOF, INCLUDING BUT NOT LIMITED TO ACCURACY OR COMPLETENESS, TITLE, ANY EPIDEMIC FAILURE WARRANTY AND ANY IMPLIED WARRANTIES OF MERCHANTABILITY, FITNESS FOR A PARTICULAR PURPOSE, AND NON-INFRINGEMENT OF ANY THIRD PARTY INTELLECTUAL PROPERTY RIGHTS. TI SHALL NOT BE LIABLE FOR AND SHALL NOT DEFEND OR INDEMNIFY DESIGNER AGAINST ANY CLAIM, INCLUDING BUT NOT LIMITED TO ANY INFRINGEMENT CLAIM THAT RELATES TO OR IS BASED ON ANY COMBINATION OF PRODUCTS EVEN IF DESCRIBED IN TI RESOURCES OR OTHERWISE. IN NO EVENT SHALL TI BE LIABLE FOR ANY ACTUAL, DIRECT, SPECIAL, COLLATERAL, INDIRECT, PUNITIVE, INCIDENTAL, CONSEQUENTIAL OR EXEMPLARY DAMAGES IN CONNECTION WITH OR ARISING OUT OF TI RESOURCES OR USE THEREOF, AND REGARDLESS OF WHETHER TI HAS BEEN ADVISED OF THE POSSIBILITY OF SUCH DAMAGES.

Unless TI has explicitly designated an individual product as meeting the requirements of a particular industry standard (e.g., ISO/TS 16949 and ISO 26262), TI is not responsible for any failure to meet such industry standard requirements.

Where TI specifically promotes products as facilitating functional safety or as compliant with industry functional safety standards, such products are intended to help enable customers to design and create their own applications that meet applicable functional safety standards and requirements. Using products in an application does not by itself establish any safety features in the application. Designers must ensure compliance with safety-related requirements and standards applicable to their applications. Designer may not use any TI products in life-critical medical equipment unless authorized officers of the parties have executed a special contract specifically governing such use. Life-critical medical equipment is medical equipment where failure of such equipment would cause serious bodily injury or death (e.g., life support, pacemakers, defibrillators, heart pumps, neurostimulators, and implantables). Such equipment includes, without limitation, all medical devices identified by the U.S. Food and Drug Administration as Class III devices and equivalent classifications outside the U.S.

TI may expressly designate certain products as completing a particular qualification (e.g., Q100, Military Grade, or Enhanced Product). Designers agree that it has the necessary expertise to select the product with the appropriate qualification designation for their applications and that proper product selection is at Designers' own risk. Designers are solely responsible for compliance with all legal and regulatory requirements in connection with such selection.

Designer will fully indemnify TI and its representatives against any damages, costs, losses, and/or liabilities arising out of Designer's non-compliance with the terms and provisions of this Notice.

Looking for pricing, stock, or lifecycle information?

Click below to explore more details on WIN SOURCE:

 [View LM4041CIDBZR on WIN SOURCE](#)

 [Texas Instruments](#) Information

Optimize Your Supply Chain with WIN SOURCE Solutions

-  Global Sourcing Solution
-  Obsolete Management
-  Cost Control Management
-  Shortage Management
-  Alternative Solution
-  Excess Inventory Management