



**THE DATASHEET OF  
LM3530UMX-25A**



# LM3530 High-Efficiency White-LED Driver with Programmable Ambient Light Sensing Capability and I<sup>2</sup>C-Compatible Interface

## 1 Features

- Drives up to 11 LEDs in series
- 1000:1 Dimming Ratio
- 90% Efficient
- Programmable Dual Ambient Light Sensor Inputs with Internal ALS Voltage Setting Resistors
- I<sup>2</sup>C Programmable Logarithmic or Linear Brightness Control
- External PWM Input for Simple Brightness Adjustment
- True Shutdown Isolation for LEDs and Ambient Light Sensors
- Internal Soft-Start Limits Inrush Current
- Wide 2.7-V to 5.5-V Input Voltage Range
- 40-V and 25-V Overvoltage Protection Options
- 500-kHz Fixed Frequency Operation
- 839-mA Peak Current Limit

## 2 Applications

- Smartphone LCD Backlighting
- Personal Navigation LCD Backlighting
- 2 to 11 Series White-LED Backlit Display Power Source

## 3 Description

The LM3530 current mode boost converter supplies the power and controls the current in up to 11 series white LEDs. The 839-mA current limit and 2.7-V to 5.5-V input voltage range make the device a versatile backlight power source ideal for operation in portable applications.

The LED current is adjustable from 0 mA to 29.5 mA via an I<sup>2</sup>C-compatible interface. The 127 different current steps and 8 different maximum LED current levels give over 1000 programmable LED current levels. Additionally, PWM brightness control is possible through an external logic level input.

The device also features two Ambient Light Sensor inputs. These are designed to monitor analog output ambient light sensors and provide programmable adjustment of the LED current with changes in ambient light. Each ambient light sensor input has independently programmable internal voltage setting resistors which can be made high impedance to reduce power during shutdown. The 500-kHz switching frequency allows for high converter efficiency over a wide output voltage range accommodating from 2 to 11 series LEDs. Finally, the support of Content Adjusted Backlighting maximizes battery life while maintaining display image quality.

The LM3530 operates over the -40°C to 85°C temperature range.

### Device Information<sup>(1)</sup>

| PART NUMBER | PACKAGE    | BODY SIZE (MAX)   |
|-------------|------------|-------------------|
| LM3530      | DSBGA (12) | 1.64 mm x 1.24 mm |

(1) For all available packages, see the orderable addendum at the end of the datasheet.

### Simplified Schematic

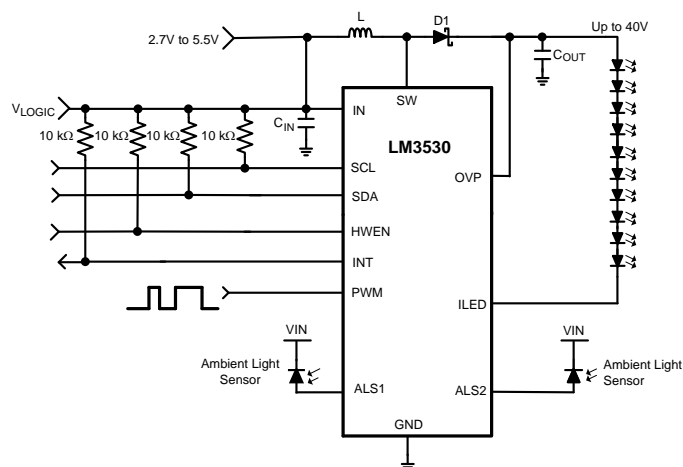



## 5 I<sup>2</sup>C Device Options

| ORDERABLE NUMBER | I <sup>2</sup> C DEVICE OPTION |
|------------------|--------------------------------|
| LM3530TME-40     | 0x38                           |
| LM3530TMX-40     | 0x38                           |
| LM3530UME-25A    | 0x36                           |
| LM3530UME-40     | 0x38                           |
| LM3530UME-40B    | 0x39                           |
| LM3530UMX-25A    | 0x36                           |
| LM3530UMX-40     | 0x38                           |
| LM3530UMX-40B    | 0x39                           |

## 6 Pin Configuration and Functions

DSBGA (YFZ or YFQ) Package  
12 Pins  
Top View

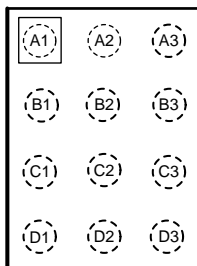

Pin Functions

| PIN    |      | TYPE | DESCRIPTION   |
|--------|------|------|---|
| NUMBER | NAME |      |   |
| A1     | SDA  | I/O  | Serial data connection for I <sup>2</sup> C-compatible interface.   |
| A2     | SCL  | I    | Serial data connection for I <sup>2</sup> C-compatible interface.   |
| A3     | SW   | PWR  | Inductor connection, diode anode connection, and drain connection for internal NFET. Connect the inductor and diode as close as possible to SW to reduce parasitic inductance and capacitive coupling to nearby traces. |
| B1     | PWM  | I    | External PWM brightness control input and simple enable input.  |
| B2     | INT  | O    | Logic interrupt output signaling the ALS zone has changed.  |
| B3     | GND  |      | Ground  |
| C1     | ALS2 | I    | Ambient light sensor input 2 with programmable internal pull-down resistor.   |
| C2     | HWEN | I    | Active high hardware enable (active low reset). pull this pin high to enable the LM3530.  |
| C3     | IN   | PWR  | Input voltage connection. Connect a 2.7-V to 5.5-V supply to IN and bypass to GND with a 2.2- $\mu$ F or greater ceramic capacitor.   |
| D1     | ALS1 | I    | Ambient light sensor input 1 with programmable internal pulldown resistor.  |
| D2     | OVP  | I    | Output voltage sense connection for overvoltage sensing. Connect OVP to the positive terminal of the output capacitor.  |
| D3     | ILED | PWR  | Input terminal to internal current sink. The boost converter regulates ILED to 0.4 V.   |

## 7 Specifications

### 7.1 Absolute Maximum Ratings

 over operating free-air temperature range (unless otherwise noted) <sup>(1)(2)(3)</sup>

|  | MIN                               | MAX | UNIT |
|--|-----------------------------------|-----|------|
| V <sub>IN</sub> to GND   | -0.3                              | 6   | V    |
| V <sub>SW</sub> , V <sub>OVP</sub> , V <sub>ILED</sub> to GND  |                                   | 45  |      |
| V <sub>SCL</sub> , V <sub>SDA</sub> , V <sub>ALS1</sub> , V <sub>PWM</sub> , V <sub>INT</sub> , V <sub>HWEN</sub> to GND |                                   | 6   |      |
| V <sub>ALS2</sub> to GND   | -0.3 V to V <sub>IN</sub> + 0.3 V |     |      |
| Continuous power dissipation   | Internally limited                |     |      |
| Junction temperature (T <sub>J-MAX</sub> )   |                                   | 150 | °C   |
| Maximum lead temperature (soldering, 10s)  | See <sup>(4)</sup>                |     |      |
| Storage temperature, T <sub>stg</sub>  | -65                               | 150 | °C   |

- Stresses beyond those listed under *Absolute Maximum Ratings* may cause permanent damage to the device. These are stress ratings only, which do not imply functional operation of the device at these or any other conditions beyond those indicated under *Recommended Operating Conditions*. Exposure to absolute-maximum-rated conditions for extended periods may affect device reliability.
- If Military/Aerospace specified devices are required, please contact the Texas Instruments Sales Office/ Distributors for availability and specifications.
- All voltages are with respect to the potential at the GND pin.
- For detailed soldering specifications and information, please refer to Application Note 1112: *DSBGA Wafer Level Chip Scale Package (SNVA009)*.

### 7.2 ESD Ratings

|  | VALUE | UNIT |
|--|-------|------|
| V <sub>(ESD)</sub> Electrostatic discharge Human-body model (HBM), per ANSI/ESDA/JEDEC JS-001 <sup>(1)</sup> | ±2000 | V    |

- JEDEC document JEP155 states that 500-V HBM allows safe manufacturing with a standard ESD control process.

### 7.3 Recommended Operating Conditions

over operating free-air temperature range (unless otherwise noted)

|   | MIN | NOM | MAX | UNIT |
|---|-----|-----|-----|------|
| V <sub>IN</sub> to GND  | 2.7 |     | 5.5 | V    |
| V <sub>SW</sub> , V <sub>OVP</sub> , V <sub>ILED</sub> , to GND | 0   |     | 40  |      |
| Junction temperature (T <sub>J</sub> ) <sup>(1)</sup>           | -40 |     | 125 | °C   |
| Ambient temperature (T <sub>A</sub> ) <sup>(2)</sup>            | -40 |     | 85  |      |

- Internal thermal shutdown circuitry protects the device from permanent damage. Thermal shutdown engages at T<sub>J</sub> = 140°C (typ.) and disengages at T<sub>J</sub> = 125°C (typ.).
- In applications where high power dissipation and/or poor package thermal resistance is present, the maximum ambient temperature may have to be derated. Maximum ambient temperature (T<sub>A-MAX</sub>) is dependent on the maximum operating junction temperature (T<sub>J-MAX-OP</sub> = 125°C), the maximum power dissipation of the device in the application (P<sub>D-MAX</sub>), and the junction-to ambient thermal resistance of the part/package in the application (R<sub>θJA</sub>), as given by the following equation: T<sub>A-MAX</sub> = T<sub>J-MAX-OP</sub> - (R<sub>θJA</sub> × P<sub>D-MAX</sub>).

### 7.4 Thermal Information

| THERMAL METRIC <sup>(1)</sup>  | DSBGA   |     | UNIT |
|--|---------|-----|------|
|  | YFQ     | YFZ |      |
|  | 12 PINS |     |      |
| R <sub>θJA</sub> Junction-to-ambient thermal resistance <sup>(2)</sup> | 61.7    |     | °C/W |

- For more information about traditional and new thermal metrics, see the *IC Package Thermal Metrics* application report, [SPRA953](#).
- Junction-to-ambient thermal resistance (R<sub>θJA</sub>) is taken from a thermal modeling result, performed under the conditions and guidelines set forth in the JEDEC standard JESD51-7. The test board is a 4-layer FR-4 board measuring 102 mm x 76 mm x 1.6 mm with a 2 x 1 array of thermal vias. The ground plane on the board is 50 mm x 50 mm. Thickness of copper layers are 36 μm/18 μm/18 μm/3 μm (1.5oz/1oz/1oz/1.5oz). Ambient temperature in simulation is 22°C in still air. Power dissipation is 1W. The value of R<sub>θJA</sub> of this product in the DSBGA package could fall in a range as wide as 60°C/W to 110°C/W (if not wider), depending on PCB material, layout, and environmental conditions. In applications where high maximum power dissipation exists special care must be paid to thermal dissipation issues.

## 7.5 Electrical Characteristics

Typical (TYP) limits are for  $T_A = 25^\circ\text{C}$ ; minimum (MIN) and maximum (MAX) apply over the full operating ambient temperature range ( $-40^\circ\text{C} \leq T_A \leq 85^\circ\text{C}$ );  $V_{IN} = 3.6\text{ V}$ , unless otherwise specified. <sup>(1)(2)</sup>

| PARAMETER       |   | TEST CONDITIONS   | MIN   | TYP    | MAX      | UNIT             |
|-----------------|---|---|-------|--------|----------|------------------|
| $I_{LED}$       | Output current regulation               | $2.7\text{ V} \geq V_{IN} \geq 5.5\text{ V}$ , Full-scale current = 19 mA, BRT Code = 0x7F, ALS Select Bit = 0, I <sup>2</sup> C Enable = 1 | 17.11 | 18.6   | 20.08    | mA               |
| $V_{REG\_CS}$   | Regulated current sink headroom voltage |   |       | 400    |          | mV               |
| $V_{HR}$        | Current sink minimum headroom voltage   | $I_{LED} = 95\%$ of nominal   |       | 200    |          | mV               |
| $R_{DSON}$      | NMOS switch on resistance               | $I_{SW} = 100\text{ mA}$  |       | 0.25   |          | $\Omega$         |
| $I_{CL}$        | NMOS switch current limit               | $2.7\text{ V} \leq V_{IN} \leq 5.5\text{ V}$  | 739   | 839    | 936      | mA               |
| $V_{OVP}$       | Output overvoltage protection           | ON Threshold, $2.7\text{ V} \leq V_{IN} \leq 5.5\text{ V}$  | 40    | 41     | 42       | V                |
|                 |   |   | 23.6  | 24     | 24.6     |                  |
|                 |   | Hysteresis  |       | 1      |          |                  |
| $f_{SW}$        | Switching frequency                     | $2.7\text{ V} \leq V_{IN} \leq 5.5\text{ V}$  | 450   | 500    | 550      | kHz              |
| $D_{MAX}$       | Maximum duty cycle                      |   |       | 94%    |          |                  |
| $D_{MIN}$       | Minimum duty cycle                      |   |       | 10%    |          |                  |
| $I_Q$           | Quiescent current, device not switching | $V_{HWEN} = V_{IN}$   |       | 490    | 600      | $\mu\text{A}$    |
| $I_{Q\_SW}$     | Switching supply current                | $I_{LED} = 19\text{ mA}$ , $V_{OUT} = 36\text{ V}$  |       | 1.35   |          | mA               |
| $I_{SHDN}$      | Shutdown current                        | $V_{HWEN} = \text{GND}$ , $2.7\text{ V} \geq V_{IN} \geq 5.5\text{ V}$  |       | 1      | 2        | $\mu\text{A}$    |
| $I_{LED\_MIN}$  | Minimum LED current                     | Full-scale current = 19 mA setting BRT = 0x01   |       | 9.5    |          | $\mu\text{A}$    |
| $V_{ALS}$       | Ambient light sensor reference voltage  | $2.7\text{ V} \geq V_{IN} \geq 5.5\text{ V}$ <sup>(3)</sup>   | 0.97  | 1      | 1.03     | V                |
| $V_{HWEN}$      | Logic thresholds - logic low            |   | 0     |        | 0.4      | V                |
|                 | Logic thresholds - logic high           |   | 1.2   |        | $V_{IN}$ |                  |
| $T_{SD}$        | Thermal shutdown                        |   |       | 140    |          | $^\circ\text{C}$ |
|                 | Hysteresis                              |   |       | 15     |          |                  |
| RALS1,<br>RALS2 | ALS input internal pull-down resistors  | $2.7\text{ V} \geq V_{IN} \geq 5.5\text{ V}$  | 12.77 | 13.531 | 14.29    | k $\Omega$       |
|                 |   |   | 8.504 | 9.011  | 9.518    |                  |
|                 |   |   | 5.107 | 5.411  | 5.715    |                  |
|                 |   |   | 2.143 | 2.271  | 2.399    |                  |
|                 |   |   | 1.836 | 1.946  | 2.055    |                  |
|                 |   |   | 1.713 | 1.815  | 1.917    |                  |
|                 |   |   | 1.510 | 1.6    | 1.69     |                  |
|                 |   |   | 1.074 | 1.138  | 1.202    |                  |
|                 |   |   | 0.991 | 1.050  | 1.109    |                  |
|                 |   |   | 0.954 | 1.011  | 1.068    |                  |
|                 |   |   | 0.888 | 0.941  | 0.994    |                  |
|                 |   |   | 0.717 | 0.759  | 0.802    |                  |
|                 |   |   | 0.679 | 0.719  | 0.760    |                  |
|                 |   |   | 0.661 | 0.700  | 0.740    |                  |
| 0.629           | 0.666                                   | 0.704   |       |        |          |                  |

(1) All voltages are with respect to the potential at the GND pin.

(2) Min and Max limits are verified by design, test, or statistical analysis. Typical (typ.) numbers are not verified, but represent the most likely norm.

(3) The ALS voltage specification is the maximum trip threshold for the ALS zone boundary (Code 0xFF). Due to random offsets and the mechanism for which the hysteresis voltage varies, it is recommended that only Codes 0x04 and above be used for Zone Boundary Thresholds. See [Zone Boundary Trip Points and Hysteresis](#) and [Minimum Zone Boundary Settings](#) sections.

### Electrical Characteristics (continued)

Typical (TYP) limits are for  $T_A = 25^\circ\text{C}$ ; minimum (MIN) and maximum (MAX) apply over the full operating ambient temperature range ( $-40^\circ\text{C} \leq T_A \leq 85^\circ\text{C}$ );  $V_{IN} = 3.6\text{ V}$ , unless otherwise specified.<sup>(1)(2)</sup>

| PARAMETER  |                             | TEST CONDITIONS                              | MIN  | TYP | MAX      | UNIT |
|--|-----------------------------|--|------|-----|----------|------|
| <b>LOGIC VOLTAGE SPECIFICATIONS (SCL, SDA, PWM, INT)</b> |                             |  |      |     |          |      |
| $V_{IL}$   | Input logic low             | $2.7\text{ V} \leq V_{IN} \leq 5.5\text{ V}$ | 0    |     | 0.54     | V    |
| $V_{IH}$   | Input logic high            | $2.7\text{ V} \leq V_{IN} \leq 5.5\text{ V}$ | 1.26 |     | $V_{IN}$ | V    |
| $V_{OL}$   | Output logic low (SDA, INT) | $I_{LOAD} = 3\text{ mA}$                     |      |     | 400      | mV   |

### 7.6 I<sup>2</sup>C-Compatible Timing Requirements (SCL, SDA)<sup>(1)</sup>

|       |  | MIN | NOM | MAX | UNIT          |
|-------|--|-----|-----|-----|---------------|
| $t_1$ | SCL (Clock Period)                       | 2.5 |     |     | $\mu\text{s}$ |
| $t_2$ | Data in setup time to SCL high           | 100 |     |     | ns            |
| $t_3$ | Data out stable after SCL low            | 0   |     |     | ns            |
| $t_4$ | SDA low setup time to SCL low (start)    | 100 |     |     | ns            |
| $t_5$ | SDA high hold time after SCL High (stop) | 100 |     |     | ns            |

(1) SCL and SDA must be glitch-free in order for proper brightness control to be realized.

### 7.7 Simple Interface Timing

|                 |  | MIN  | NOM | MAX  | UNIT |
|-----------------|--|------|-----|------|------|
| $t_{PWM\_HIGH}$ | Enable time, PWM pin must be held high | 1.5  | 2   | 2.6  | ms   |
| $t_{PWM\_LOW}$  | Disable time, PWM pin must be held low | 1.48 | 2   | 2.69 |      |

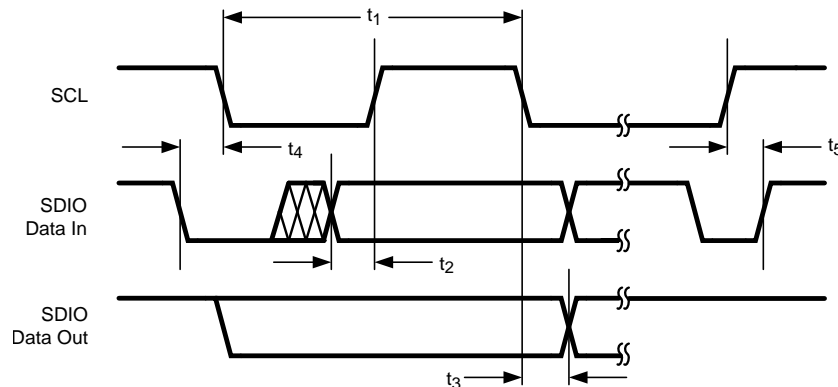

Figure 1. I<sup>2</sup>C-Compatible Timing

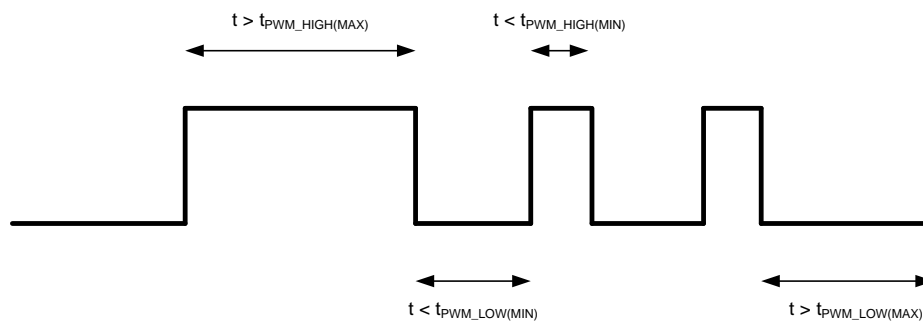
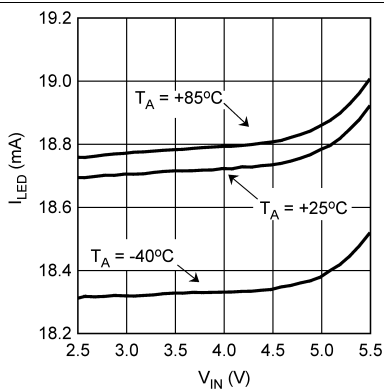

Figure 2. Simple Enable/Disable Timing

### 7.8 Typical Characteristics

$V_{IN} = 3.6\text{ V}$ , LEDs are OVSRAWAC1R6 from OPTEK Technology,  $C_{OUT} = 1\ \mu\text{F}$ ,  $C_{IN} = 1\ \mu\text{F}$ ,  $L = \text{TDK VLF5012ST-100M1R0}$ , ( $R_L = 0.24\ \Omega$ ),  $I_{LED} = 19\text{ mA}$ ,  $T_A = 25^\circ\text{C}$ , unless otherwise specified.



$I_{FULL\_SCALE} = 19\text{ mA}$

Figure 3. LED Current vs  $V_{IN}$

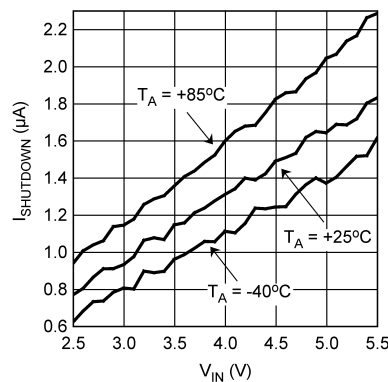
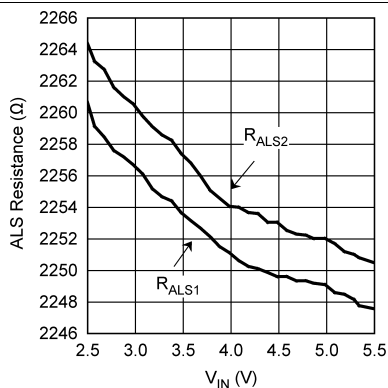
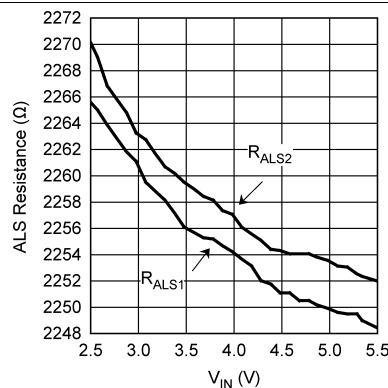

Figure 4. Shutdown Current vs  $V_{IN}$



ALS Resistor Select Register = 0x44

Figure 5. Internal ALS Resistor vs  $V_{IN}$



$T_A = 85^\circ\text{C}$  ALS Resistor Select Register = 0x44

Figure 6. Internal ALS Resistor vs  $V_{IN}$

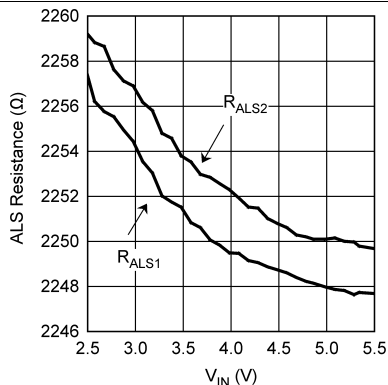

$T_A = -40^\circ\text{C}$  ALS Resistor Select Register = 0x44

Figure 7. Internal ALS Resistor vs  $V_{IN}$

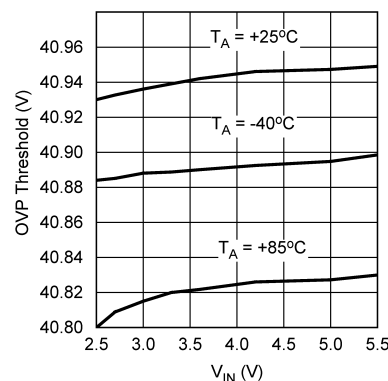

$V_{OUT}$  Rising

Figure 8. Overvoltage Protection vs  $V_{IN}$

**Typical Characteristics (continued)**

$V_{IN} = 3.6\text{ V}$ , LEDs are OVSRWAC1R6 from OPTEK Technology,  $C_{OUT} = 1\ \mu\text{F}$ ,  $C_{IN} = 1\ \mu\text{F}$ ,  $L = \text{TDK VLF5012ST-100M1R0}$ , ( $R_L = 0.24\ \Omega$ ),  $I_{LED} = 19\ \text{mA}$ ,  $T_A = 25^\circ\text{C}$ , unless otherwise specified.

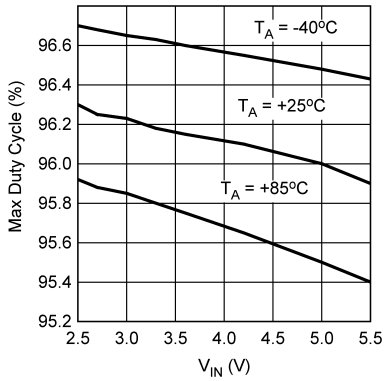

**Figure 9. Max Duty Cycle vs  $V_{IN}$**

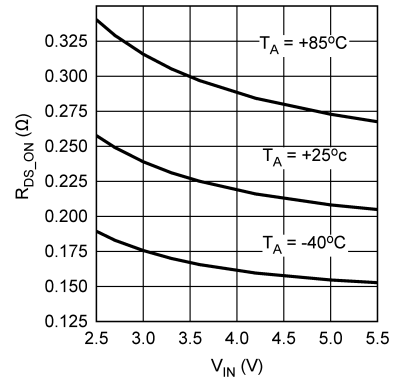

**Figure 10. NFET Switch On-Resistance vs  $V_{IN}$**

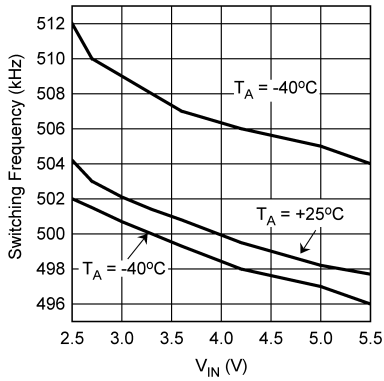

**Figure 11. Switching Frequency vs  $V_{IN}$**

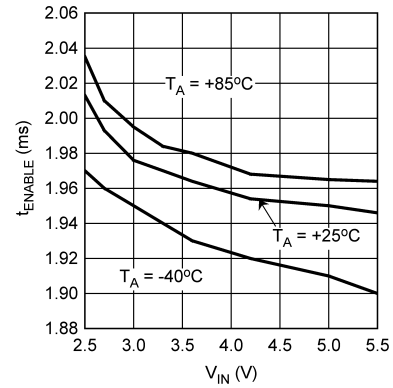

**Figure 12. Simple Enable Time vs  $V_{IN}$**

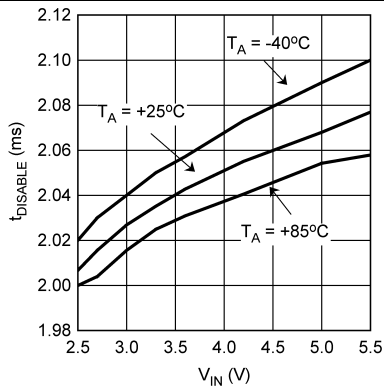

**Figure 13. Simple Disable Time vs  $V_{IN}$**

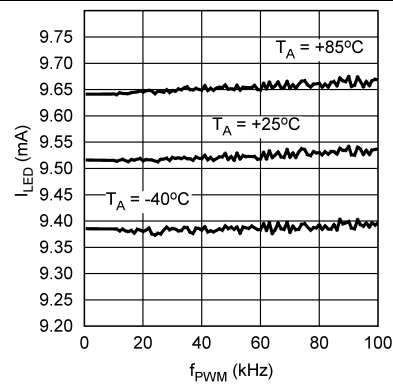

$I_{LED}$  Full Scale = 19 mA      50% Duty Cycle

**Figure 14.  $I_{LED}$  vs  $f_{PWM}$**

Typical Characteristics (continued)

$V_{IN} = 3.6\text{ V}$ , LEDs are OVSRWAC1R6 from OPTEK Technology,  $C_{OUT} = 1\ \mu\text{F}$ ,  $C_{IN} = 1\ \mu\text{F}$ ,  $L = \text{TDK VLF5012ST-100M1R0}$ , ( $R_L = 0.24\ \Omega$ ),  $I_{LED} = 19\ \text{mA}$ ,  $T_A = 25^\circ\text{C}$ , unless otherwise specified.

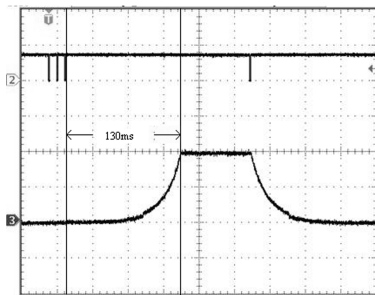

Channel 2: SDA (5V/div) Time Base (40ms/div)  
Channel 3:  $I_{LED}$  (10mA/div)  
1.024ms/Step Up And Down

Figure 15. Ramp Rate (Exponential)

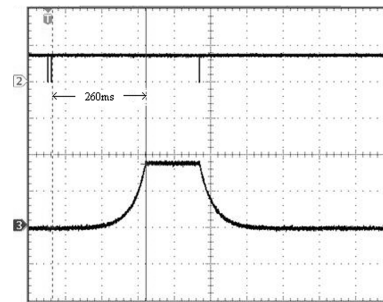

Channel 2: SDA (5V/div) Time Base (100ms/div)  
Channel 3:  $I_{LED}$  (10mA/div)  
2.048ms/Step Up And Down

Figure 16. Ramp Rate (Exponential)

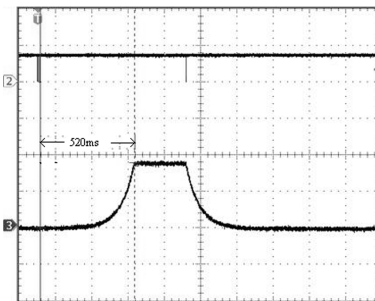

Channel 2: SDA (5V/div) Time Base (200ms/div)  
Channel 3:  $I_{LED}$  (10mA/div)  
4.096ms/Step Up And Down

Figure 17. Ramp Rate (Exponential)

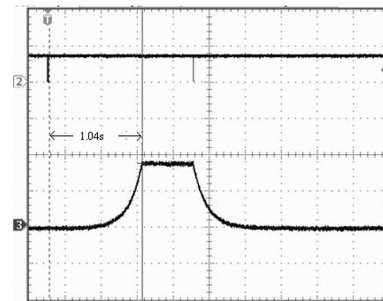

Channel 2: SDA (5V/div) Time Base (400ms/div)  
Channel 3:  $I_{LED}$  (10mA/div)  
8.192ms/Step Up And Down

Figure 18. Ramp Rate (Exponential)

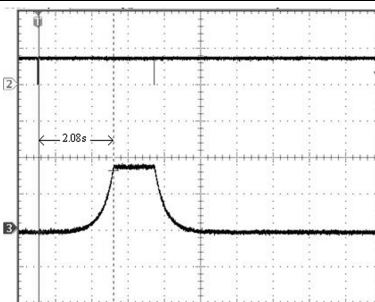

Channel 2: SDA (5V/div) Time Base (1s/div)  
Channel 3:  $I_{LED}$  (10mA/div)  
16.384ms/Step Up And Down

Figure 19. Ramp Rate (Exponential)

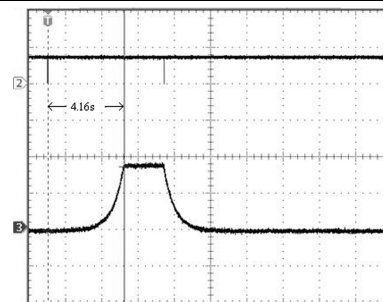

Channel 2: SDA (5V/div) Time Base (2s/div)  
Channel 3:  $I_{LED}$  (10mA/div)  
32.768ms/Step Up And Down

Figure 20. Ramp Rate (Exponential)

Typical Characteristics (continued)

$V_{IN} = 3.6\text{ V}$ , LEDs are OVSRAWAC1R6 from OPTEK Technology,  $C_{OUT} = 1\ \mu\text{F}$ ,  $C_{IN} = 1\ \mu\text{F}$ ,  $L = \text{TDK VLF5012ST-100M1R0}$ , ( $R_L = 0.24\ \Omega$ ),  $I_{LED} = 19\text{ mA}$ ,  $T_A = 25^\circ\text{C}$ , unless otherwise specified.

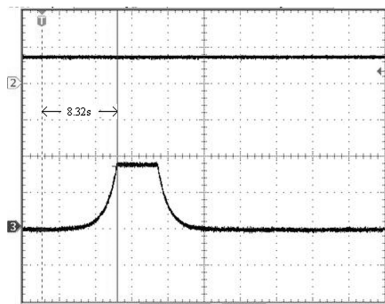

Channel 2: SDA (5V/div) Time Base (4s/div)  
 Channel 3:  $I_{LED}$  (10mA/div)  
 65.538ms/Step Up And Down

Figure 21. Ramp Rate (Exponential)

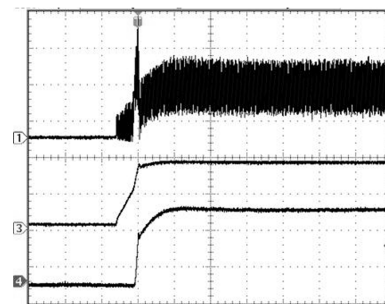

Channel 1:  $I_{IN}$  (200mA/div) Time Base (2ms/div)  
 Channel 3:  $V_{OUT}$  (20V/div) Ramp Rate =  $8\ \mu\text{s}/\text{Step}$   
 Channel 4 (10mA/div)  $I_{LED} = 19\text{ mA}$   
 $L = 22\ \mu\text{H}$   $V_{IN} = 3.6\text{ V}$

Figure 22. Start-up Plot



Channel 1:  $V_{IN}$  (500mV/div) Time Base (400µs/div)  
 Channel 2:  $V_{OUT}$  (500mV/div)  $L = 22\ \mu\text{H}$   
 Channel 3:  $I_{LED}$  (500µA/div)  $I_{LED} = 19\text{ mA}$   
 $V_{IN}$  From 3.6 V To 3.2 V

Figure 23. Line Step Response

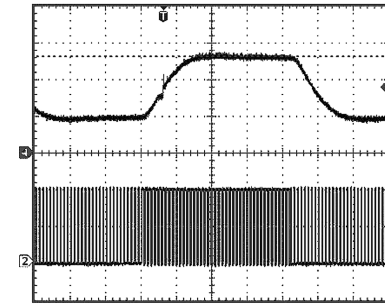

Channel 2: PWM (5V/div) Time Base (2ms/div)  
 Channel 4:  $I_{LED}$  (5mA/div)  $I_{LED}$  Full Scale = 19 mA  
 $D_{PWM}$  From 30% To 70%  $F_{PWM} = 5\text{ kHz}$

Figure 24.  $I_{LED}$  Response To Step Change In PWM Duty Cycle

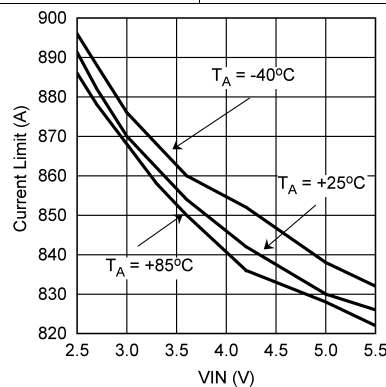

Closed Loop

$L = 22\ \mu\text{H}$

The value for current limit given in the [Electrical Characteristics](#) is measured in an open loop test by forcing current into SW until the current limit comparator threshold is reached. The typical curve for current limit is measured in closed loop using the typical application circuit by increasing  $I_{OUT}$  until the peak inductor current stops increasing. Closed loop data appears higher due to the delay between the comparator trip point and the NFET turning off. This delay allows the closed loop inductor current to ramp higher after the trip point by approximately  $100\text{ ns} \times V_{IN}/L$ .

Figure 25. Current Limit vs  $V_{IN}$

## 8 Detailed Description

### 8.1 Overview

The LM3530 utilizes an asynchronous step-up, current mode, PWM controller and regulated current sink to provide an efficient and accurate LED current for white LED bias. The device powers a single series string of LEDs with output voltages of up to 40 V and a peak inductor current of typically 839 mA. The input active voltage range is from 2.7 V to 5.5 V.

### 8.2 Functional Block Diagram

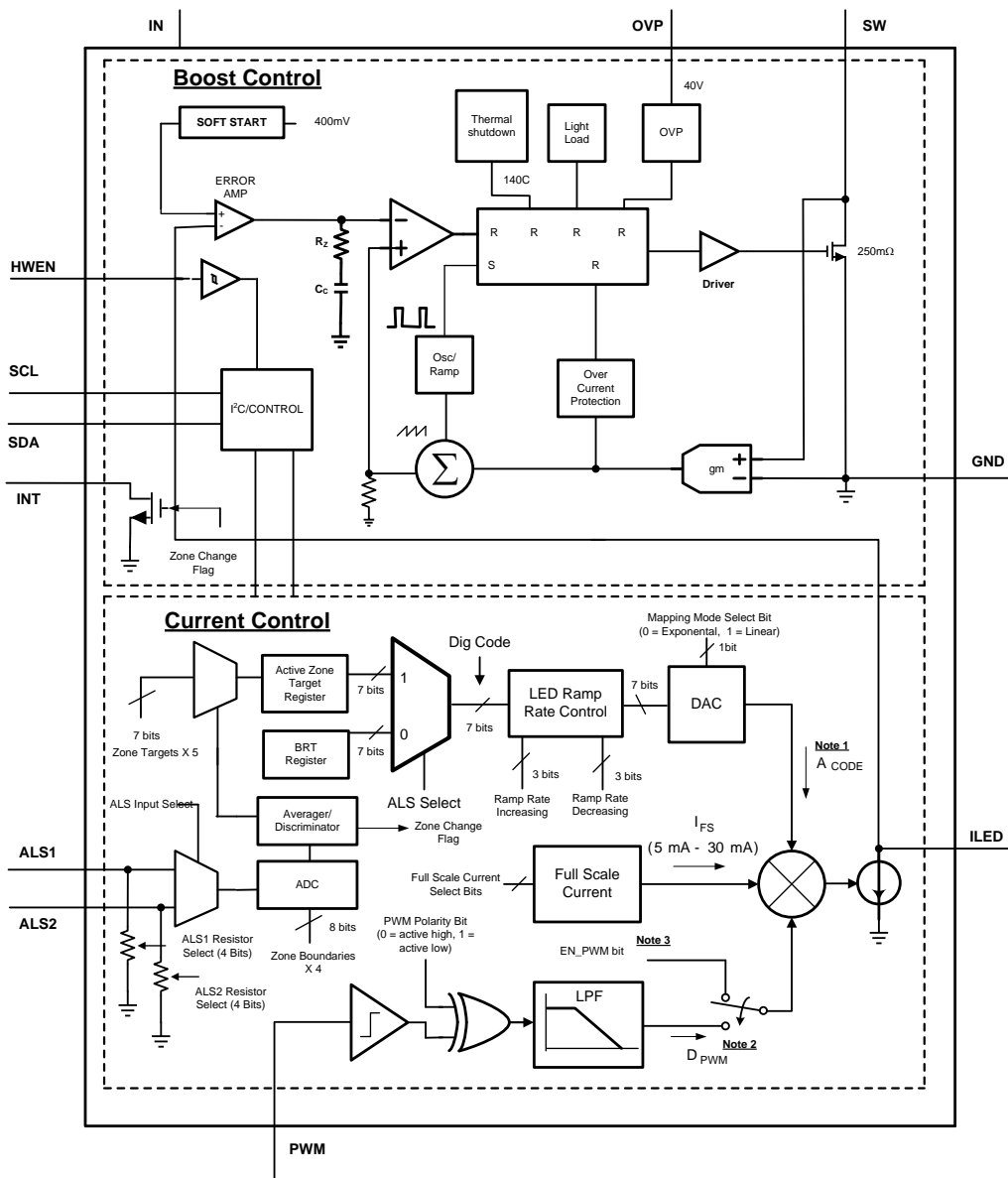

- Note 1:  $A_{CODE}$  is a Scaler between 0 and 1 based on the Brightness Data or Zone Target Data Depending on the ALS Select Bit
- Note 2:  $D_{PWM}$  is a Scaler between 0 and 1 and corresponds to the duty cycle of the PWM input signal
- Note 3: For EN\_PWM bit = 1  
 $I_{LED} = I_{FS} \times A_{CODE} \times D_{PWM}$   
 For EN\_PWM bit = 0  
 $I_{LED} = I_{FS} \times A_{CODE}$

## 8.3 Feature Description

### 8.3.1 Start-Up

An internal soft-start prevents large inrush currents during start-up that can cause excessive current spikes at the input. For the typical application circuit (using a 10- $\mu$ H inductor, a 2.2- $\mu$ F input capacitor, and a 1- $\mu$ F output capacitor) the average input current during start-up ramps from 0 to 300 mA in 3 ms. See [Figure 22](#) in the [Typical Characteristics](#).

### 8.3.2 Light Load Operation

The LM3530 boost converter operates in three modes: continuous conduction, discontinuous conduction, and skip mode. Under heavy loads when the inductor current does not reach zero before the end of the switching period, the device switches at a constant frequency (500 kHz typical). As the output current decreases and the inductor current reaches zero before the end of the switching period, the device operates in discontinuous conduction. At very light loads the LM3530 will enter skip mode operation causing the switching period to lengthen and the device to only switch as required to maintain regulation at the output. Light load operation provides for improved efficiency at lighter LED currents compared to continuous and discontinuous conduction. This is due to the pulsed frequency operation resulting in decreased switching losses in the boost converter.

### 8.3.3 Ambient Light Sensor

The LM3530 incorporates a dual input Ambient Light Sensing interface (ALS1 and ALS2) which translates an analog output ambient light sensor to a user-specified brightness level. The ambient light sensing circuit has 4 programmable boundaries (ZB0 – ZB3) which define 5 ambient brightness zones. Each ambient brightness zone corresponds to a programmable brightness threshold (Z0T – Z4T). The ALS interface is programmable to accept the ambient light information from either the highest voltage of ALS1 or ALS2, the average voltage of ALS1 or ALS2, or selectable from either ALS1 or ALS2.

Furthermore, each ambient light sensing input (ALS1 or ALS2) features 15 internal software selectable voltage setting resistors. This allows the LM3530 the capability of interfacing with a wide selection of ambient light sensors. Additionally, the ALS inputs can be configured as high impedance, thus providing for a true shutdown during low power modes. The ALS resistors are selectable through the ALS Resistor Select Register (see [Table 9](#)). [Figure 26](#) shows a functional block diagram of the ambient light sensor input. VSNS represents the active input as described in [Table 6](#) bits [6:5].

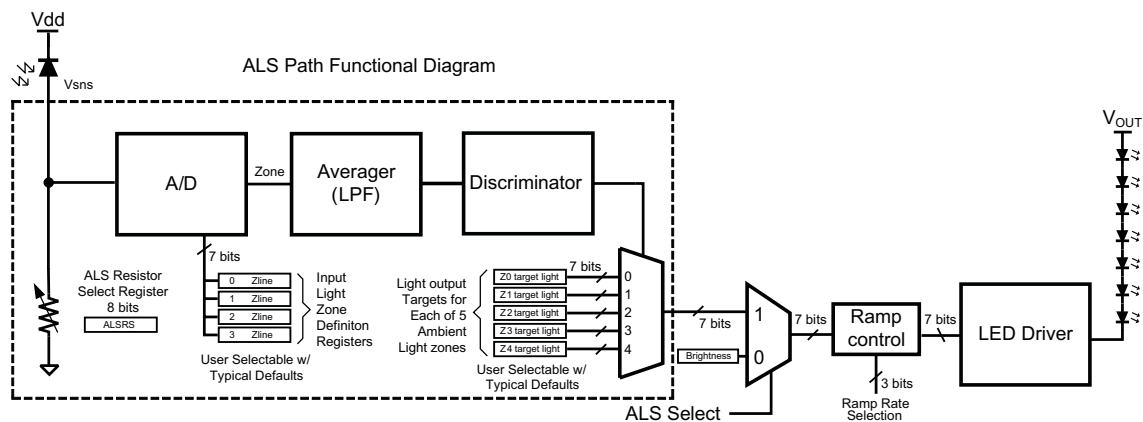

**Figure 26. Ambient Light Sensor Functional Block Diagram**

## Feature Description (continued)

### 8.3.4 ALS Operation

The ambient light sensor input has a 0-V to 1-V operational input voltage range. [LM3530 Typical Application](#) shows the LM3530 with dual ambient light sensors (AVAGO, APDS-9005) and the internal ALS Resistor Select Register set to 0x44 (2.27 kΩ). This circuit converts 0 to 1000 LUX light into approximately a 0-mV to 850-mV linear output voltage. The voltage at the active ambient light sensor input (ALS1 or ALS2) is compared against the 8 bit values programmed into the Zone Boundary Registers (ZB0-ZB3). When the ambient light sensor output crosses one of the ZB0 – ZB3 programmed thresholds the internal ALS circuitry will smoothly transition the LED current to the new 7 bit brightness level as programmed into the appropriate Zone Target Register (Z0T – Z4T) (see [Figure 27](#)).

The ALS Configuration Register bits [6:5] programs which input is the active input, bits [4:3] control the on/off state of the ALS circuitry, and bits [2:0] control the ALS input averaging time. Additionally, the ALS Information Register is a read-only register which contains a flag (bit 3) which is set each time the active ALS input changes to a new zone. This flag is reset when the register is read back. Bits [2:0] of this register contain the current active zone information.

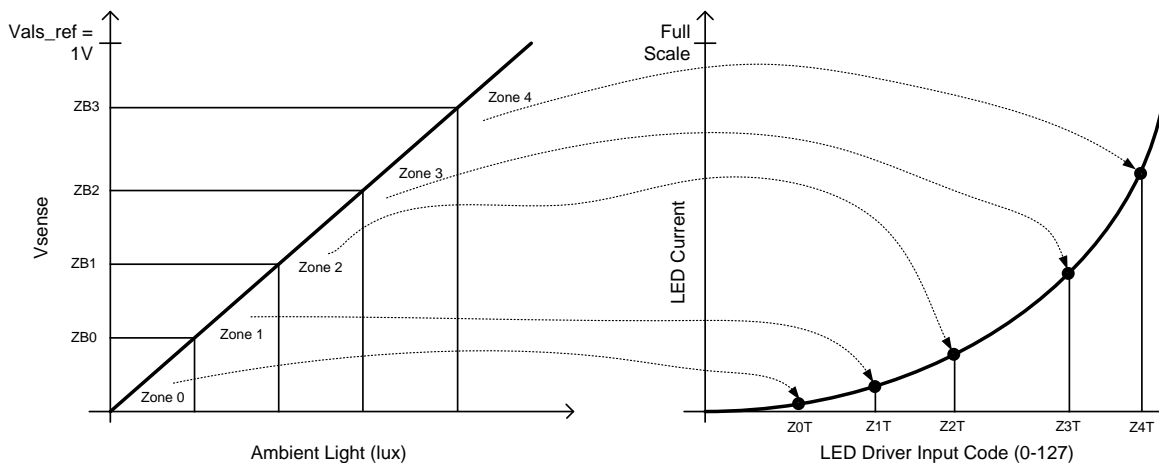

Figure 27. Ambient Light Input To Backlight Mapping

### 8.3.5 ALS Averaging Time

The ALS Averaging Time is the time over which the Averager block collects samples from the A/D converter and then averages them to pass to the discriminator block (see [Figure 26](#)). Ambient light sensor samples are averaged and then further processed by the discriminator block to provide rejection of noise and transient signals. The averager is configurable with 8 different averaging times to provide varying amounts of noise and transient rejection (see [Table 5](#)). The discriminator block algorithm has a maximum latency of two averaging cycles; therefore, the averaging time selection determines the amount of delay that will exist between a steady-state change in the ambient light conditions and the associated change of the backlight illumination. For example, the A/D converter samples the ALS inputs at 16 kHz. If the averaging time is set to 1024 ms then the Averager will send the updated zone information to the discriminator every 1024 ms. This zone information contains the average of 16384 samples (1024 ms × 16 kHz). Due to the latency of 2 averaging cycles, the LED current will not change until there has been a steady-state change in the ambient light for at least 2 averaging periods.

#### 8.3.5.1 Averager Operation

The magnitude and direction (either increasing or decreasing) of the Averager output is used to determine whether the LM3530 should change brightness zones. The Averager block functions as follows:

1. First, the Averager always begins with a Zone 0 reading at start-up. If the main display LEDs are active before the ALS block is enabled, it is recommended that the ALS Enable 1 bit is set to '1' at least 3 averaging periods before the ALS Enable 2 bit is set.

### Feature Description (continued)

2. The Averager will always round down to the lower zone in the event of a non-integer zone average. For example, if during an averaging period the ALS input transitions between zones 1 and 2 resulting in an averager output of 1.75, then the averager output will round down to 1 (see [Figure 28](#)).
3. The two most current averaging samples are used to make zone change decisions.
4. To make a zone change, data from three averaging cycles are needed. (Starting Value, First Transition, Second Transition or Rest).
5. To increase the brightness zone, the Averager output must have increased for at least 2 averaging periods or increased and remained at the new level for at least two averaging periods ('+' to '+' or '+' to 'Rest' in [Figure 29](#)).
6. To decrease the brightness zone, the Averager output must have decreased for at least 2 averaging periods or decreased and remained at the new level for at least two averaging periods ('-' to '-' or '-' to 'Rest' in [Figure 29](#)).

In the case of two consecutive increases or decreases in the Averager output, the LM3530 will transition to zone equal to the last averager output ([Figure 29](#)).

Using the diagram for the ALS block ([Figure 26](#)), the flow of information is shown in ([Figure 30](#)). This starts with the ALS input into the A/D, into the Averager, and then into the Discriminator. Each state filters the previous output to help prevent unwanted zone to zone transitions.

When using the ALS averaging function, it is important to remember that the averaging cycle is free running and is not synchronized with changing ambient lighting conditions. Due to the nature of the averager round down, an increase in brightness can take between 2 and 3 averaging cycles to change zones, while a decrease in brightness can take between 1 and 2 averaging cycles. See [Table 6](#) for a list of possible Averager periods. [Figure 31](#) shows an example of how the perceived brightness change time can vary.

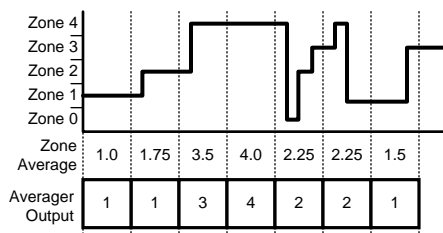

**Figure 28. Averager Calculation**

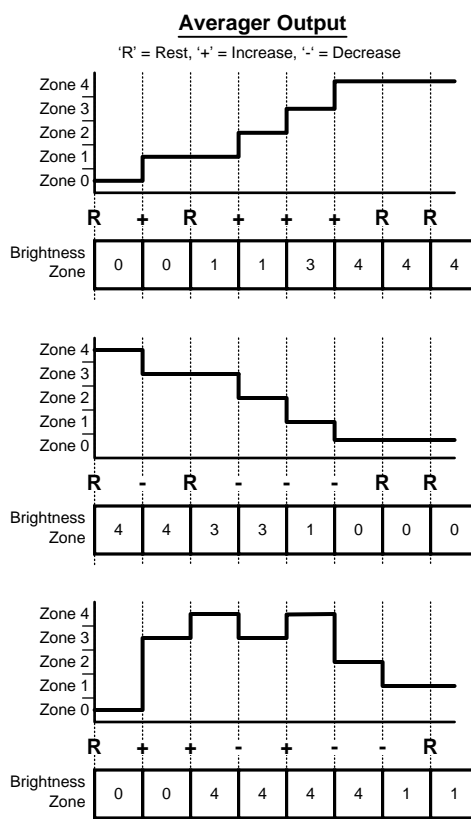

**Figure 29. Brightness Zone Change Examples**

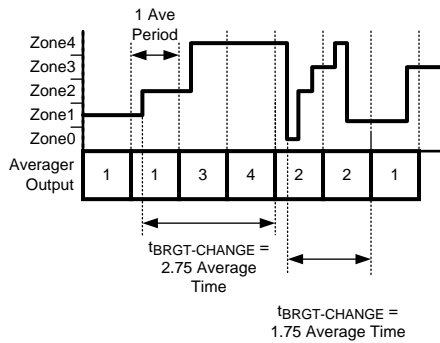

**Figure 30. Ambient Light Input To Backlight Transition**

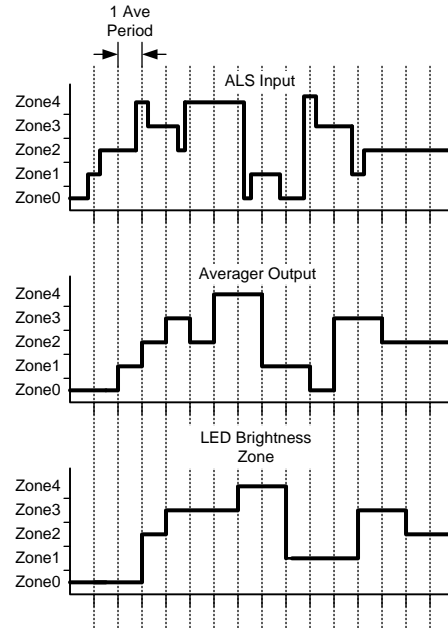

**Figure 31. Perceived Brightness Change Time**

### 8.3.6 Zone Boundary Settings

Registers 0x60, 0x61, 0x62, and 0x63 set the 4 zone boundaries (thresholds) for the ALS inputs. These 4 zone boundaries create 5 brightness zones which map over to 5 separate brightness zone targets (see Figure 27). Each 8-bit zone boundary register can set a threshold from typically 0 to 1 V with linear step sizes of approximately  $1/255 = 3.92$  mV. Additionally, each zone boundary has built in hysteresis which can be either lower or higher than the programmed Zone Boundary depending on the last direction (either up or down) of the ALS input voltage.

### 8.3.7 Zone Boundary Trip Points and Hysteresis

For each zone boundary setting, the trip point will vary above or below the nominal set point depending on the direction (either up or down) of the ALS input voltage. This is designed to keep the ALS input from oscillating back and forth between zones in the event that the ALS voltage is residing near to the programmed zone boundary threshold. The Zone Boundary Hysteresis will follow these 2 rules:

1. If the last zone transition was from low to high, then the trip point ( $V_{TRIP}$ ) will be  $V_{ZONE\_BOUNDARY} - V_{HYST}/2$ , where  $V_{ZONE\_BOUNDARY}$  is the zone boundary set point as programmed into the Zone Boundary registers, and  $V_{HYST}$  is typically 7 mV.
2. If the last zone transition was from high to low then the trip point ( $V_{TRIP}$ ) will be  $V_{ZONE\_BOUNDARY} + V_{HYST}/2$ .

Figure 32 details how the LM3530 ALS Input Zone Boundary Thresholds vary depending on the direction of the ALS input voltage.

Referring to Figure 32, each numbered trip point shown is determined from the direction of the previous ALS zone transition.

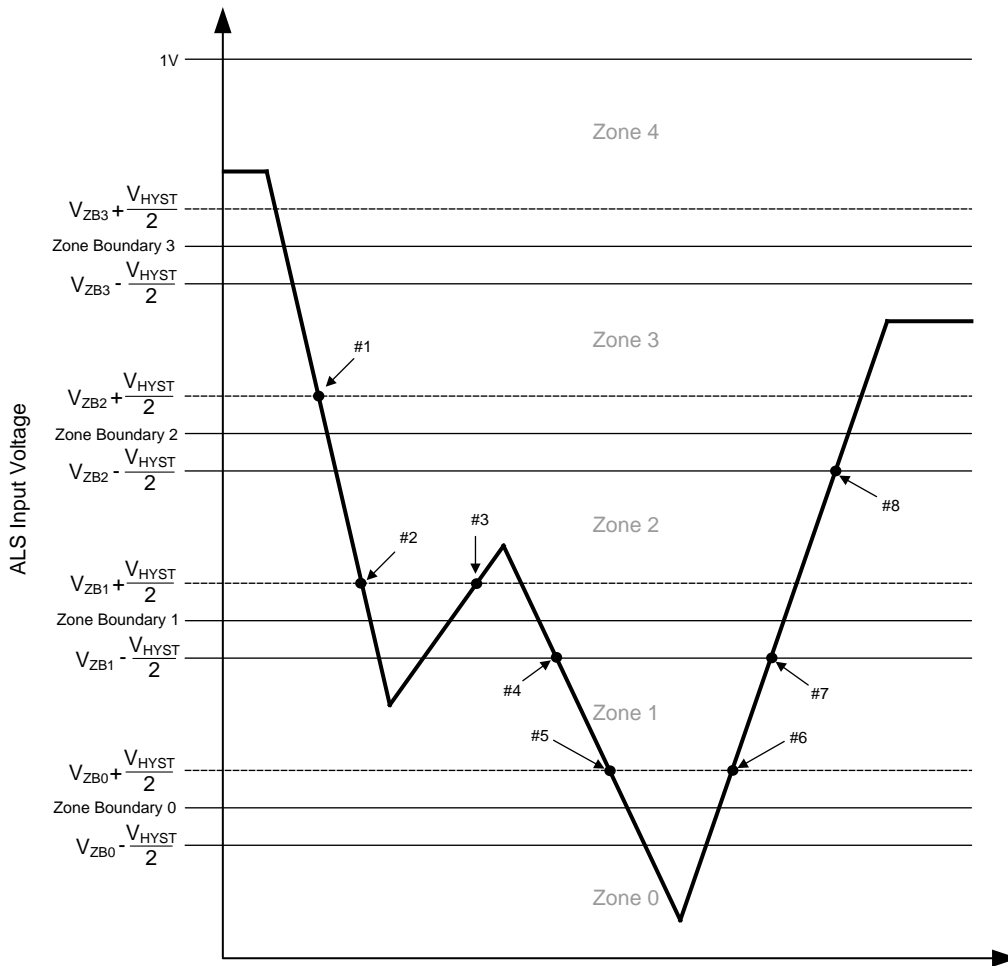

Figure 32. Zone Boundaries With Hysteresis

### 8.3.8 Minimum Zone Boundary Settings

The actual minimum zone boundary setting is code 0x03. Codes of 0x00, 0x01, and 0x02 are all mapped to code 0x03. Table 1 shows the Zone Boundary codes 0x00 through 0x04, the typical thresholds, and the high and low hysteresis values. The remapping of codes 0x00 - 0x02 plus the additional 4mV of offset voltage is necessary to prevent random offsets and noise on the ALS inputs from creating threshold levels that are below GND. This essentially guarantees that any Zone Boundary threshold selected is achievable with positive ALS voltages.

Table 1. Ideal Zone Boundary Settings with Hysteresis (Lower 5 Codes)

| ZONE BOUNDARY CODE | TYPICAL ZONE BOUNDARY THRESHOLD (mV) | TYPICAL THRESHOLD + HYSTERESIS (mV) | TYPICAL THRESHOLD - HYSTERESIS (mV) |
|--------------------|--------------------------------------|-------------------------------------|-------------------------------------|
| 0x00               | 15.8                                 | 19.3                                | 12.3                                |
| 0x01               | 15.8                                 | 19.3                                | 12.3                                |
| 0x02               | 15.8                                 | 19.3                                | 12.3                                |
| 0x03               | 15.8                                 | 19.3                                | 12.3                                |
| 0x04               | 19.7                                 | 23.2                                | 16.2                                |

### 8.3.9 LED Current Control

The LED current is a function of the Full Scale Current, the Brightness Code, and the PWM input duty cycle. The Brightness Code can either come from the BRT Register (0xA0) in I<sup>2</sup>C-Compatible Current Control, or from the ALS Zone Target Registers (Address 0x70-0x74) in Ambient Light Current Control. Figure 33 shows the current control block diagram.

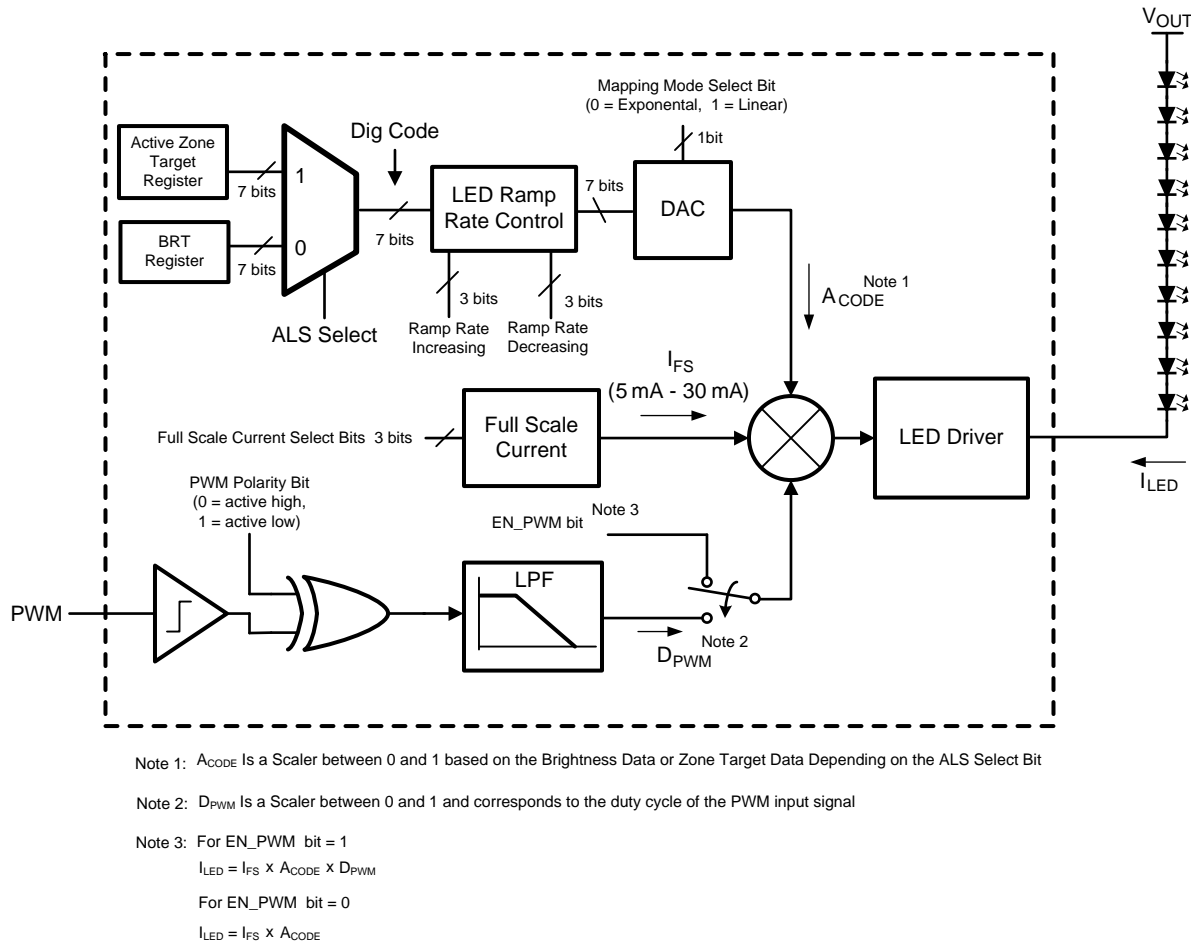

Figure 33. Current Control Block Diagram

### 8.3.10 Exponential or Linear Brightness Mapping Modes

With bit [1] of the General Configuration Register set to 0 (default) exponential mapping is selected and the code in the Brightness Control Register corresponds to the Full-Scale LED current percentages in Table 2 and Figure 34. With bit [1] set to 1 linear mapping is selected and the code in the Brightness Control Register corresponds to the Full-Scale LED current percentages in Table 3 and Figure 35.

### 8.3.11 PWM Input Polarity

Bit [6] of the General Configuration Register controls the PWM input polarity. Setting this bit to 0 (default) selects positive polarity and makes the LED current (with PWM mode enabled) a function of the positive duty cycle at PWM. With this bit set to '0' the LED current (with PWM mode enabled) becomes a function of the negative duty cycle at PWM.

The PWM input is a logic level input with a frequency range of 400 Hz to 50 kHz. Internal filtering of the PWM input signal converts the duty cycle information to an average (analog) control signal which directly controls the LED current.

*Example: PWM + I<sup>2</sup>C-Compatible Current Control:*

As an example, assume the the General Configuration Register is loaded with (0x2D). From [Table 5](#), this sets up the LM3530 with:

- Simple Enable OFF (bit 7 = 0)
- Positive PWM Polarity (bit 6 = 0)
- PWM Enabled (bit 5 = 1)
- Full-Scale Current set at 15.5 mA (bits [4:2] = 100)
- Brightness Mapping set for Exponential (bit 1 = 0)
- Device Enabled via I<sup>2</sup>C (bit 0 = 1)

Next, the Brightness Control Register is loaded with 0x73. This sets the LED current to 51.406% of full scale (see [Equation 1](#)). Finally, the PWM input is driven with a 0-V to 2-V pulse waveform at 70% duty cycle. The LED current under these conditions will be:

$$I_{LED} = I_{LED\_FS} \times BRT \times D = 15.5 \text{ mA} \times 51.4\% \times 70\% \approx 5.58 \text{ mA.}$$

where

- BRT is the percentage of  $I_{LED\_FS}$  as set in the Brightness Control Register (1)

### 8.3.12 I<sup>2</sup>C-Compatible Current Control Only

I<sup>2</sup>C-Compatible Control is enabled by writing a '1' to the I<sup>2</sup>C Device Enable bit (bit [0] of the General Configuration Register), a '0' to the Simple Enable bit (bit 7), and a '0' to the PWM Enable bit (bit 5). With bit 5 = 0, the duty cycle information at the PWM input is not used in setting the LED current.

In this mode the LED current is a function of the Full-Scale LED current bits (bits [4:2] of the General Configuration Register) and the code in the Brightness Control Register. The LED current mapping for the Brightness Control Register can be linear or exponential depending on bit [1] in the General Configuration Register (see [Exponential or Linear Brightness Mapping Modes](#) section). Using I<sup>2</sup>C-Compatible Control Only, the Full-Scale LED Current bits and the Brightness Control Register code provides nearly 1016 possible current levels selectable over the I<sup>2</sup>C-compatible interface.

*Example: I<sup>2</sup>C-Compatible Current Control Only:*

As an example, assume the General Configuration Register is loaded with 0x15. From [Table 5](#) this sets up the LM3530 with:

- Simple Enable OFF (bit 7 = 0)
- Positive PWM Polarity (bit 6 = 0)
- PWM Disabled (bit 5 = 0)
- Full-Scale Current set at 22.5mA (bits [4:2] = 101)
- Brightness Mapping set for Exponential (bit 1 = 0)
- Device Enabled via I<sup>2</sup>C (bit 0 = 1)

The Brightness Control Register is then loaded with 0x72 (48.438% of full-scale current from [Equation 2](#)). The LED current with this configuration becomes:

$$I_{LED} = I_{LED\_FS} \times BRT = 22.5 \text{ mA} \times 0.48438 \approx 10.9 \text{ mA.}$$

where

- BRT is the % of  $I_{LED\_FS}$  as set in the Brightness Control Register. (2)

Next, the brightness mapping is set to linear mapping mode (bit [1] in General Configuration Register set to 1). Using the same Full-Scale current settings and Brightness Control Register settings as before, the LED current becomes:

$$I_{LED} = I_{LED\_FS} \times BRT = 22.5 \text{ mA} \times 0.8976 \approx 20.2 \text{ mA.} \quad (3)$$

Which is higher now since the code in the Brightness Control Register (0x72) corresponds to 89.76% of Full-Scale LED Current due to the different mapping mode given in [Figure 34](#).

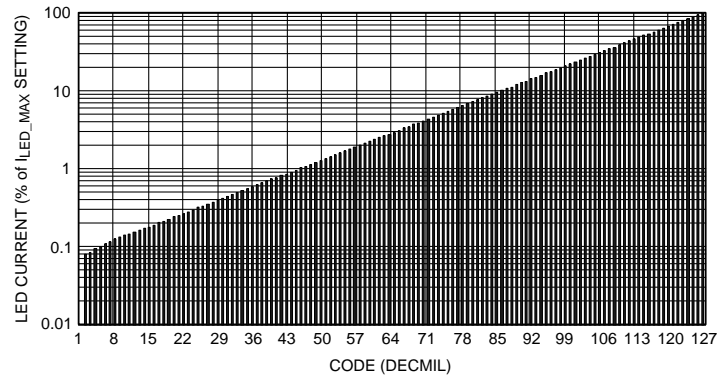

**Figure 34. Exponential Brightness Mapping**

**Table 2. I<sub>LED</sub> vs. Brightness Register Data (Exponential Mapping)**

| BRT DATA (HEX) | % FULL-SCALE CURRENT | BRT DATA (HEX) | % OF FULL-SCALE CURRENT | BRT DATA (HEX) | % OF FULL-SCALE CURRENT | BRT DATA (HEX) | % OF FULL-SCALE CURRENT |
|----------------|----------------------|----------------|-------------------------|----------------|-------------------------|----------------|-------------------------|
| 0x00           | 0.00%                | 0x20           | 0.500%                  | 0x40           | 2.953%                  | 0x60           | 17.813%                 |
| 0x01           | 0.080%               | 0x21           | 0.523%                  | 0x41           | 3.125%                  | 0x61           | 18.750%                 |
| 0x02           | 0.086%               | 0x22           | 0.555%                  | 0x42           | 3.336%                  | 0x62           | 19.922%                 |
| 0x03           | 0.094%               | 0x23           | 0.586%                  | 0x43           | 3.500%                  | 0x63           | 20.859%                 |
| 0x04           | 0.102%               | 0x24           | 0.617%                  | 0x44           | 3.719%                  | 0x64           | 22.266%                 |
| 0x05           | 0.109%               | 0x25           | 0.656%                  | 0x45           | 3.906%                  | 0x65           | 23.438%                 |
| 0x06           | 0.117%               | 0x26           | 0.695%                  | 0x46           | 4.141%                  | 0x66           | 24.844%                 |
| 0x07           | 0.125%               | 0x27           | 0.734%                  | 0x47           | 4.375%                  | 0x67           | 26.250%                 |
| 0x08           | 0.133%               | 0x28           | 0.773%                  | 0x48           | 4.648%                  | 0x68           | 27.656%                 |
| 0x09           | 0.141%               | 0x29           | 0.820%                  | 0x49           | 4.922%                  | 0x69           | 29.297%                 |
| 0x0A           | 0.148%               | 0x2A           | 0.867%                  | 0x4A           | 5.195%                  | 0x6A           | 31.172%                 |
| 0x0B           | 0.156%               | 0x2B           | 0.914%                  | 0x4B           | 5.469%                  | 0x6B           | 32.813%                 |
| 0x0C           | 0.164%               | 0x2C           | 0.969%                  | 0x4C           | 5.781%                  | 0x6C           | 34.453%                 |
| 0x0D           | 0.172%               | 0x2D           | 1.031%                  | 0x4D           | 6.125%                  | 0x6D           | 35.547%                 |
| 0x0E           | 0.180%               | 0x2E           | 1.078%                  | 0x4E           | 6.484%                  | 0x6E           | 38.828%                 |
| 0x0F           | 0.188%               | 0x2F           | 1.148%                  | 0x4F           | 6.875%                  | 0x6F           | 41.016%                 |
| 0x10           | 0.203%               | 0x30           | 1.219%                  | 0x50           | 7.266%                  | 0x70           | 43.203%                 |
| 0x11           | 0.211%               | 0x31           | 1.281%                  | 0x51           | 7.656%                  | 0x71           | 45.938%                 |
| 0x12           | 0.227%               | 0x32           | 1.359%                  | 0x52           | 8.047%                  | 0x72           | 48.438%                 |
| 0x13           | 0.242%               | 0x33           | 1.430%                  | 0x53           | 8.594%                  | 0x73           | 51.406%                 |
| 0x14           | 0.250%               | 0x34           | 1.523%                  | 0x54           | 9.063%                  | 0x74           | 54.141%                 |
| 0x15           | 0.266%               | 0x35           | 1.594%                  | 0x55           | 9.609%                  | 0x75           | 57.031%                 |
| 0x16           | 0.281%               | 0x36           | 1.688%                  | 0x56           | 10.078%                 | 0x76           | 60.703%                 |
| 0x17           | 0.297%               | 0x37           | 1.781%                  | 0x57           | 10.781%                 | 0x77           | 63.984%                 |
| 0x18           | 0.320%               | 0x38           | 1.898%                  | 0x58           | 11.250%                 | 0x78           | 67.813%                 |
| 0x19           | 0.336%               | 0x39           | 2.016%                  | 0x59           | 11.953%                 | 0x79           | 71.875%                 |
| 0x1A           | 0.352%               | 0x3A           | 2.109%                  | 0x5A           | 12.656%                 | 0x7A           | 75.781%                 |
| 0x1B           | 0.375%               | 0x3B           | 2.250%                  | 0x5B           | 13.359%                 | 0x7B           | 79.688%                 |
| 0x1C           | 0.398%               | 0x3C           | 2.367%                  | 0x5C           | 14.219%                 | 0x7C           | 84.375%                 |

**Table 2.  $I_{LED}$  vs. Brightness Register Data (Exponential Mapping) (continued)**

| BRT DATA (HEX) | % FULL-SCALE CURRENT | BRT DATA (HEX) | % OF FULL-SCALE CURRENT | BRT DATA (HEX) | % OF FULL-SCALE CURRENT | BRT DATA (HEX) | % OF FULL-SCALE CURRENT |
|----------------|----------------------|----------------|-------------------------|----------------|-------------------------|----------------|-------------------------|
| 0x1D           | 0.422%               | 0x3D           | 2.508%                  | 0x5D           | 15.000%                 | 0x7D           | 89.844%                 |
| 0x1E           | 0.445%               | 0x3E           | 2.648%                  | 0x5E           | 15.859%                 | 0x7E           | 94.531%                 |
| 0x1F           | 0.469%               | 0x3F           | 2.789%                  | 0x5F           | 16.875%                 | 0x7F           | 100.00%                 |

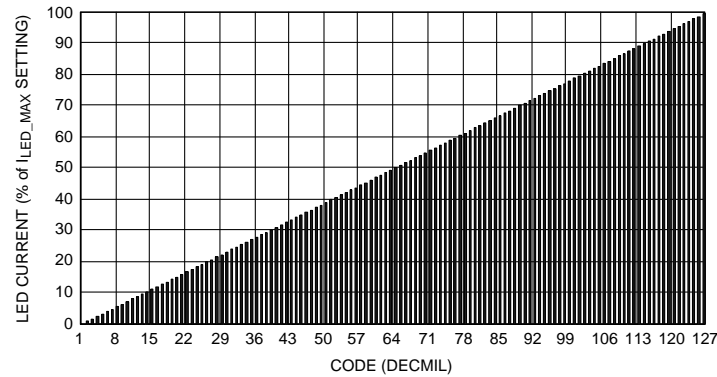

**Figure 35. Linear Brightness Mapping**

**Table 3.  $I_{LED}$  vs. Brightness Register Data (Linear Mapping)**

| BRT DATA (HEX) | % FULL-SCALE CURRENT (LINEAR) | BRT DATA (HEX) | % OF FULL-SCALE CURRENT (LINEAR) | BRT DATA (HEX) | % OF FULL-SCALE CURRENT (LINEAR) | BRT DATA (HEX) | % OF FULL-SCALE CURRENT (LINEAR) |
|----------------|-------------------------------|----------------|----------------------------------|----------------|----------------------------------|----------------|----------------------------------|
| 0x00           | 0.00%                         | 0x20           | 25.79%                           | 0x40           | 50.78%                           | 0x60           | 75.78%                           |
| 0x01           | 1.57%                         | 0x21           | 26.57%                           | 0x41           | 51.57%                           | 0x61           | 76.56%                           |
| 0x02           | 2.35%                         | 0x22           | 27.35%                           | 0x42           | 52.35%                           | 0x62           | 77.35%                           |
| 0x03           | 3.13%                         | 0x23           | 28.13%                           | 0x43           | 53.13%                           | 0x63           | 78.13%                           |
| 0x04           | 3.91%                         | 0x24           | 28.91%                           | 0x44           | 53.91%                           | 0x64           | 78.91%                           |
| 0x05           | 4.69%                         | 0x25           | 29.69%                           | 0x45           | 54.69%                           | 0x65           | 79.69%                           |
| 0x06           | 5.48%                         | 0x26           | 30.47%                           | 0x46           | 55.47%                           | 0x66           | 80.47%                           |
| 0x07           | 6.26%                         | 0x27           | 31.25%                           | 0x47           | 56.25%                           | 0x67           | 81.25%                           |
| 0x08           | 7.04%                         | 0x28           | 32.04%                           | 0x48           | 57.03%                           | 0x68           | 82.03%                           |
| 0x09           | 7.82%                         | 0x29           | 32.82%                           | 0x49           | 57.82%                           | 0x69           | 82.81%                           |
| 0x0A           | 8.60%                         | 0x2A           | 33.60%                           | 0x4A           | 58.60%                           | 0x6A           | 83.59%                           |
| 0x0B           | 9.38%                         | 0x2B           | 34.38%                           | 0x4B           | 59.38%                           | 0x6B           | 84.38%                           |
| 0x0C           | 10.16%                        | 0x2C           | 35.16%                           | 0x4C           | 60.16%                           | 0x6C           | 85.16%                           |
| 0x0D           | 10.94%                        | 0x2D           | 35.94%                           | 0x4D           | 60.94%                           | 0x6D           | 85.94%                           |
| 0x0E           | 11.72%                        | 0x2E           | 36.72%                           | 0x4E           | 61.72%                           | 0x6E           | 86.72%                           |
| 0x0F           | 12.51%                        | 0x2F           | 37.50%                           | 0x4F           | 62.50%                           | 0x6F           | 87.50%                           |
| 0x10           | 13.29%                        | 0x30           | 38.29%                           | 0x50           | 63.28%                           | 0x70           | 88.28%                           |
| 0x11           | 14.07%                        | 0x31           | 39.07%                           | 0x51           | 64.06%                           | 0x71           | 89.06%                           |
| 0x12           | 14.85%                        | 0x32           | 39.85%                           | 0x52           | 64.85%                           | 0x72           | 89.84%                           |

**Table 3. I<sub>LED</sub> vs. Brightness Register Data (Linear Mapping) (continued)**

| BRT DATA (HEX) | % FULL-SCALE CURRENT (LINEAR) | BRT DATA (HEX) | % OF FULL-SCALE CURRENT (LINEAR) | BRT DATA (HEX) | % OF FULL-SCALE CURRENT (LINEAR) | BRT DATA (HEX) | % OF FULL-SCALE CURRENT (LINEAR) |
|----------------|-------------------------------|----------------|----------------------------------|----------------|----------------------------------|----------------|----------------------------------|
| 0x13           | 15.63%                        | 0x33           | 40.63%                           | 0x53           | 65.63%                           | 0x73           | 90.63%                           |
| 0x14           | 16.41%                        | 0x34           | 41.41%                           | 0x54           | 66.41%                           | 0x74           | 91.41%                           |
| 0x15           | 17.19%                        | 0x35           | 42.19%                           | 0x55           | 67.19%                           | 0x75           | 92.19%                           |
| 0x16           | 17.97%                        | 0x36           | 42.97%                           | 0x56           | 67.97%                           | 0x76           | 92.97%                           |
| 0x17           | 18.76%                        | 0x37           | 43.75%                           | 0x57           | 68.75%                           | 0x77           | 93.75%                           |
| 0x18           | 19.54%                        | 0x38           | 44.53%                           | 0x58           | 69.53%                           | 0x78           | 94.53%                           |
| 0x19           | 20.32%                        | 0x39           | 45.32%                           | 0x59           | 70.39%                           | 0x79           | 95.31%                           |
| 0x1A           | 21.10%                        | 0x3A           | 46.10%                           | 0x5A           | 71.10%                           | 0x7A           | 96.09%                           |
| 0x1B           | 21.88%                        | 0x3B           | 46.88%                           | 0x5B           | 71.88%                           | 0x7B           | 96.88%                           |
| 0x1C           | 22.66%                        | 0x3C           | 47.66%                           | 0x5C           | 72.66%                           | 0x7C           | 97.66%                           |
| 0x1D           | 23.44%                        | 0x3D           | 48.44%                           | 0x5D           | 73.44%                           | 0x7D           | 98.44%                           |
| 0x1E           | 24.22%                        | 0x3E           | 49.22%                           | 0x5E           | 74.22%                           | 0x7E           | 99.22%                           |
| 0x1F           | 25.00%                        | 0x3F           | 50.00%                           | 0x5F           | 75.00%                           | 0x7F           | 100.00%                          |

**NOTE**

When determining the LED current from (Table 2 and Table 3 ) there is a typical offset of 113  $\mu$ A with a  $\pm 300$ - $\mu$ A variation that must be added to the calculated value for codes 0x0A and below. For example, in linear mode with  $I_{FULL\_SCALE} = 19$  mA and brightness code 0x09 chosen, the nominal current setting is  $0.0782 \times 19$  mA = 1.4858 mA. Adding in the 113- $\mu$ A typical offset gives 1.4858 mA + 0.113 mA = 1.5988 mA. With the typical  $\pm 300$ - $\mu$ A range, the high and low currents can be  $I_{LOW} = 1.2988$  mA,  $I_{HIGH} = 1.8988$  mA. For exponential mode with codes 0x0A and below, this offset and variation error gets divided down by 10 (11.3  $\mu$ A offset with  $\pm 30$ - $\mu$ A typical range).

**8.3.13 Simple Enable Disable With PWM Current Control**

With bits [7 and 5] of the General Configuration Register set to '1' the PWM input is enabled as a simple enable/disable. The simple enable/disable feature operates as described in Figure 36. In this mode, when the PWM input is held high (PWM Polarity bit = 0) for > 2 ms the LM3530 will turn on the LED current at the programmed Full-Scale Current  $\times$  % of Full-Scale Current as set by the code in the Brightness Control Register. When the PWM input is held low for > 2 ms the device will shut down. With the PWM Polarity bit = 1 the PWM input is configured for active low operation. In this configuration holding PWM low for > 2 ms will turn on the device at the programmed Full-Scale Current  $\times$  % of Full-Scale Current as set by the code in the Brightness Control Register. Likewise, holding PWM high for > 2 ms will put the device in shutdown.

Driving the PWM input with a pulsed waveform at a variable duty cycle is also possible in simple enable/Disable mode, so long as the low pulse width is < 2 ms. When a PWM signal is used in this mode the input duty cycle information is internally filtered, and an analog voltage is used to control the LED current. This type of PWM control (PWM to Analog current control) prevents large voltage excursions across the output capacitor that can result in audible noise. Simple Enable/Disable mode can be useful since the default bit setting for the General Configuration Register is 0xCC (Simple Enable bit = 1, PWM Enable = 1, and Full-Scale Current = 19mA). Additionally, the default Brightness Register setting is 0x7F (100% of Full-Scale current). This gives the LM3530 the ability to turn on after power up (or after reset) without having to do any writes to the I<sup>2</sup>C-compatible bus.

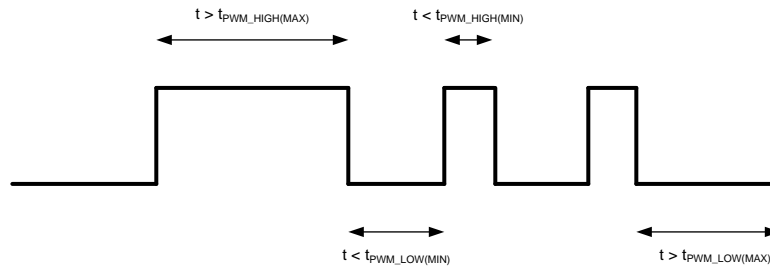
**Figure 36. Simple Enable/Disable Timing**

*Example: Simple Enable Disable with PWM Current Control:*

As an example, assume that the HWEN input is toggled low then high. This resets the LM3530 and sets all the registers to their default value. When the PWM input is then pulled high for > 2 ms the LED current becomes:

$$I_{LED} = I_{LED\_FS} \times BRT \times D = 19 \text{ mA} \times 1.00 \times 100\% \approx 19 \text{ mA.}$$

where

- BRT is the % of  $I_{LED\_FS}$  as set in the Brightness Control Register. (4)

If then the PWM input is fed with a 5-kHz pulsed waveform at 40% duty cycle the LED current becomes:

$$I_{LED} = I_{LED\_FS} \times BRT \times D = 19 \text{ mA} \times 1.00 \times 0.4 \approx 7.6 \text{ mA.} \quad (5)$$

Then, if the Brightness Control Register is loaded with 0x55 (9.6% of Full-Scale Current) the LED current becomes:

$$I_{LED} = I_{LED\_FS} \times BRT \times D = 19 \text{ mA} \times 9.65 \times 0.4 \approx 0.73 \text{ mA.} \quad (6)$$

### 8.3.14 Ambient Light Current Control

With bits [4:3] of the ALS Configuration Register both set to 1, the LM3530 is configured for Ambient Light Current Control. In this mode the ambient light sensing inputs (ALS1, and/or ALS2) monitor the outputs of analog output ambient light sensing photo diodes and adjust the LED current depending on the ambient light. The ambient light sensing circuit has 4 configurable Ambient Light Boundaries (ZB0 – ZB3) programmed through the four (8-bit) Zone Boundary Registers. These zone boundaries define 5 ambient brightness zones (Figure 27). Each zone corresponds to a programmable brightness setting which is programmable through the 5 Zone Target Registers (Z0T – Z4T). When the ALS1, and/or ALS2 input (depending on the bit settings of the ALS Input Select bits) detects that the ambient light has crossed to a new zone (as defined by one of the Zone Boundary Registers) the LED current becomes a function of the Brightness Code loaded in the Zone Target Register which corresponds to the new ambient light brightness zone.

On start-up the 4 Zone Boundary Registers are pre-loaded with 0x33 (51d), 0x66 (102d), 0x99 (153d), and 0xCC (204d). Each ALS input has a 1-V active input voltage range with a 4mV offset voltage which makes the default Zone Boundaries set at:

$$\text{Zone Boundary 0} = 1\text{V} \times 51/255 + 4 \text{ mV} = 204 \text{ mV}$$

$$\text{Zone Boundary 1} = 1\text{V} \times 102/255 + 4 \text{ mV} = 404 \text{ mV}$$

$$\text{Zone Boundary 2} = 1\text{V} \times 153/255 + 4 \text{ mV} = 604 \text{ mV}$$

$$\text{Zone Boundary 3} = 1\text{V} \times 204/255 + 4 \text{ mV} = 804 \text{ mV}$$

These Zone Boundary Registers are all 8-bit (readable and writable) registers. The first zone (Z0) is defined between 0 and 204 mV, the Z1 default is defined between 204 mV and 404 mV, the Z2 default is defined between 404 mV and 604 mV, the Z3 default is defined between 604 mV and 804 mV, and the Z4 default is defined between 804 mV and 1.004 V. The default settings for the 5 Zone Target Registers are 0x19, 0x33, 0x4C, 0x66, and 0x7F. This corresponds to LED brightness settings of 0.336%, 1.43%, 5.781%, 24.844%, and 100% of full-scale current respectively (assuming exponential backlight mapping).

*Example: Ambient Light Control Current:*

As an example, assume that the APDS-9005 is used as the ambient light sensing photo diode with its output connected to the ALS1 input. The ALS Resistor Select Register is loaded with 0x04 which configures the ALS1 input for a 2.27-kΩ internal pull-down resistor (see [Table 9](#)). The APDS-9005 has a typical 400nA/LUX response. With a 2.27-kΩ resistor the sensor output would see a 0-mV to 908-mV swing with a 0 to 1000 LUX change in ambient light. Next, the ALS Configuration Register is programmed with 0x3C. From [Table 6](#), this configures the LM3530's ambient light sensing interface for:

ALS1 as the active ALS input (bits [6:5] = 01)

Ambient Light Current Control Enabled (bit 4 = 1)

ALS circuitry Enabled (bit 3 = 1)

Sets the ALS Averaging Time to 512 ms (bits [2:0] = 100)

Next, the General Configuration Register is programmed with 0x19 which sets the Full-Scale Current to 26 mA, selects Exponential Brightness Mapping, and enables the device via the I<sup>2</sup>C-compatible interface.

Now assume that the APDS-9005 ambient light sensor detects a 100 LUX ambient light at its input. This forces the ambient light sensors output (and the ALS1 input) to 87.5mV corresponding to Zone 0. Since Zone 0 points to the brightness code programmed in Zone Target Register 0 (loaded with code 0x19), the LED current becomes:

$$I_{LED} = I_{LED\_FS} \times ZoneTarget0 = 26 \text{ mA} \times 0.336\% \approx 87 \mu\text{A}. \quad (7)$$

Where the code in Zone Target Register 0 points to the % of I<sub>LED\_FS</sub> as given by [Table 2](#) or [Table 3](#), depending on whether Exponential or Linear Mapping are selected.

Next, assume that the ambient light changes to 500 LUX (corresponding to an ALS1 voltage of 454 mV). This moves the ambient light into Zone 2 which corresponds to Zone Target Register 2 (loaded with code 0x4C) the LED current then becomes:

$$I_{LED} = I_{LED\_FS} \times ZoneTarget2 = 26 \text{ mA} \times 5.781\% \approx 1.5 \text{ mA}. \quad (8)$$

### 8.3.15 Ambient Light Current Control + PWM

The Ambient Light Current Control can also be a function of the PWM input duty cycle. Assume the LM3530 is configured as described in the above Ambient Light Current Control example, but this time the Enable PWM bit set to '1' (General Configuration Register bit [5]).

*Example: Ambient Light Current Control + PWM*

In this example, the APDS-9005 detects that the ambient light has changed to 1 kLUX. The voltage at ALS1 is now around 908 mV, and the ambient light falls within Zone 5. This causes the LED brightness to be a function of Zone Target Register 5 (loaded with 0x7F). Now assume the PWM input is also driven with a 50% duty cycle pulsed waveform. The LED current now becomes:

$$I_{LED} = I_{LED\_FS} \times ZoneTarget5 \times D = 26 \text{ mA} \times 100\% \times 50\% \approx 13 \text{ mA}. \quad (9)$$

*Example: ALS Averaging:*

As an example, suppose the LM3530 ALS Configuration Register is loaded with 0x3B. This configures the device for:

- ALS1 as the active ALS input (bits [6:5] = 01)
- Enables Ambient Light Current Control (bit 4 = 1)
- Enables the ALS circuitry (bit 3 = 1)
- Sets the ALS Averaging Time to 256 ms (bits [2:0] = 011)

Next, the ALS Resistor Select Register is loaded with 0x04. This configures the ALS2 input as high impedance and configures the ALS1 input with a 2.27-k $\Omega$  internal pull-down resistor. The Zone Boundary Registers and Zone Target Registers are left with their default values. The Brightness Ramp Rate Register is loaded with 0x2D. This sets up the LED current ramp rate at 16.384 ms/step. Finally, the General Configuration Register is loaded with 0x15. This sets up the device with:

- Simple Enable OFF (bit 7 = 0)
- PWM Polarity High (bit 6 = 0)
- PWM Input Disabled (bit 5 = 0)
- Full-Scale Current = 22.5mA (bits [4:2] = 101)
- Brightness Mapping Mode as Exponential (bit 1 = 0)
- Device Enabled via I<sup>2</sup>C (bit 0 = 1)

As the device starts up the APDS-9005 ambient light sensor (connected to the ALS1 input) detects 500 LUX. This puts approximately 437.5 mV at ALS1 (see [Figure 37](#)). This places the measured ambient light between Zone Boundary Registers 1 and 2, thus corresponding to Zone Target Register 2. The default value for this register is 0x4C. The LED current is programmed to:

$$I_{LED} = I_{LED\_FS} \times \text{ZoneTarget2} = 22.5 \text{ mA} \times 5.781\% \approx 1.3 \text{ mA.} \quad (10)$$

Referring to [Figure 37](#), initially the Averager is loaded with Zone 0 so it takes 2 averaging periods for the LM3530 to change to the new zone. After the ALS1 voltage remains at 437.5 mV for two averaging periods (end of period 2) the LM3530 repeats Zone 2 and signals the LED current to begin ramping to the Zone 2 target beginning at average period 3. Since the ramp rate is set at 16.384 ms/step the LED current goes from 0 to 1.3 mA in  $76 \times 16.384 \text{ ms} = 1.245\text{s}$  (approximately 5 average periods).

After the LED current has been at its steady state of 1.3 mA for a while, the ambient light suddenly steps to 900 LUX for 500 ms and then steps back to 500 LUX. In this case the 900 LUX will place the ALS1 voltage at approximately 979 mV corresponding to Zone 4 somewhere during average period 10 and fall back to 437.5 mV somewhere during average period 12. The averager output during period #10 goes to 3, and then during period 11, goes to 4. Since there have been 2 increases in the average during period 10 and period 11, the beginning of average period #12 shows a change in the brightness zone to Zone 4. This results in the LED current ramping to the new value of 22.5 mA (the Zone 4 target). During period #12 the ambient light steps back to 500 LUX and forces ALS1 to 437.5 mV (corresponding to Zone 2). After average period 12 and period 13 have shown that the averager transitioned lower two times, the brightness zone changes to the new target at the beginning of period 14. This signals the LED current to ramp down to the zone 2 target of 1.3 mA. Looking back at average period 12 and period 13, the LED current was only able to ramp up to 7.38 mA due to the ramp rate of 16.384 ms/step (2 average periods of 256 ms each) before it was instructed to ramp back to the Zone 2 target at the start of period 14. This example demonstrates not only the averaging feature, but how additional filtering of transient events on the ALS inputs can be accomplished by using the LED current ramp rates.

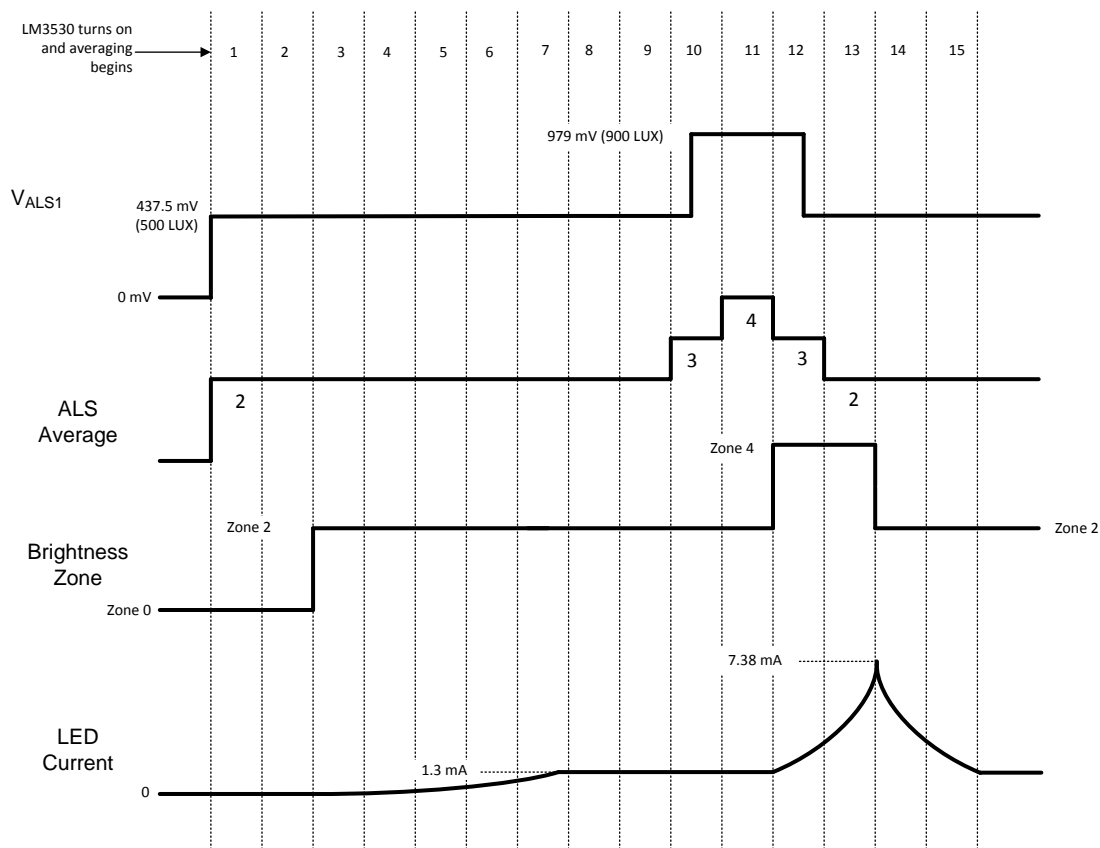

Figure 37. ALS Averaging Example

### 8.3.16 Interrupt Output

INT is an open-drain output which pulls low when the Ambient Light Sensing circuit has transitioned to a new ambient brightness zone. When a read-back of the ALS Information Register is done INT is reset to the open drain state.

### 8.3.17 Overvoltage Protection

Overvoltage protection is set at 40 V (minimum) for the LM3530-40 and 23.6 V minimum for the LM3530-25. The 40-V version allows typically up to 11 series white LEDs (assuming 3.5 V per LED + 400 mV headroom voltage for the current sink = 38.9 V). When the OVP threshold is reached the LM3530 switching converter stops switching, allowing the output voltage to discharge. Switching will resume when the output voltage falls to typically 1 V below the OVP threshold. In the event of an LED open circuit the output will be limited to around 40 V with a small amount of voltage ripple. The 25-V version allows up to 6 series white LEDs (assuming 3.5-V per LED + 400 mV headroom voltage for the current sink = 21.4 V). The 25-V OVP option allows for the use of lower voltage and smaller sized (25 V) output capacitors. The 40-V device would typically require a 50-V output capacitor.

### 8.3.18 Hardware Enable

The HWEN input is an active high hardware enable which must be pulled high to enable the device. Pulling this pin low disables the I<sup>2</sup>C-compatible interface, the simple enable/disable input, the PWM input, and resets all registers to their default state (see Table 4).

### 8.3.19 Thermal Shutdown

In the event the die temperature reaches 140°C, the LM3530 will stop switching until the die temperature cools by 15°C. In a thermal shutdown event the device is not placed in reset; therefore, the contents of the registers are left in their current state.

## 8.4 Device Functional Modes

### 8.4.1 Shutdown

With HWEN Low, or bit 0 in register 0x10 set to 0, the device is in shutdown. In this mode the boost converter and the current sink are both off and the supply current into IN is reduced to typically 1 µA.

### 8.4.2 I<sup>2</sup>C Mode

I<sup>2</sup>C-Compatible Control Mode is enabled by writing a '1' to the I<sup>2</sup>C Device Enable bit (bit [0] of the General Configuration Register), a '0' to the Simple Enable bit (bit 7), and a '0' to the PWM Enable bit (bit 5). With bit 5 = 0, the duty cycle information at the PWM input is not used in setting the LED current. In this mode the LED current is a function of the Full-Scale LED current bits (bits [4:2] of the General Configuration Register) and the code in the Brightness Control Register. The LED current mapping for the Brightness Control Register can be linear or exponential depending on bit [1] in the General Configuration Register (see Exponential or Linear Brightness Mapping Modes section). Using I<sup>2</sup>C-Compatible Control Only, the Full-Scale LED Current bits and the Brightness Control Register code provides nearly 1016 possible current levels selectable over the I<sup>2</sup>C-compatible interface.

### 8.4.3 PWM + I<sup>2</sup>C Mode

PWM + I<sup>2</sup>C-compatible current control mode is enabled by writing a '1' to the Enable PWM bit (General Configuration Register bit [5]) and writing a '1' to the I<sup>2</sup>C Device Enable bit (General Configuration Register bit 0). This makes the LED current a function of the PWM input duty cycle (D), the Full-Scale LED current (I<sub>LED\_FS</sub>), and the % of full-scale LED current. The % of Full-Scale LED current is set by the code in the Brightness Control Register. The LED current using PWM + I<sup>2</sup>C-Compatible Control is given by [Equation 11](#):

$$I_{LED} = I_{LED\_FS} \times BRT \times D \quad (11)$$

BRT is the percentage of Full Scale Current as set in the Brightness Control Register. The Brightness Control Register can have either exponential or linear brightness mapping depending on the setting of the BMM bit (bit [1] in General Configuration Register).

### 8.4.4 ALS Mode

With bits [4:3] of the ALS Configuration Register both set to 1, the LM3530 is configured for Ambient Light Current Control. In this mode the ambient light sensing inputs (ALS1, and/or ALS2) monitor the outputs of analog output ambient light sensing photo diodes and adjust the LED current depending on the ambient light.

### 8.4.5 Simple Enable Mode

Simple Enable Mode With bits [7 and 5] of the General Configuration Register set to '1' the PWM input is enabled as a simple enable/disable. The simple enable/disable feature operates as described in Figure 36. In this mode, when the PWM input is held high (PWM Polarity bit = 0) for > 2 ms the LM3530 will turn on the LED current at the programmed Full-Scale Current × % of Full-Scale Current as set by the code in the Brightness Control Register. When the PWM input is held low for > 2 ms the device will shut down.

## 8.5 Programming

### 8.5.1 I<sup>2</sup>C-Compatible Interface

#### 8.5.1.1 Start and Stop Condition

The LM3530 is controlled via an I<sup>2</sup>C-compatible interface. START and STOP conditions classify the beginning and the end of the I<sup>2</sup>C session. A START condition is defined as SDA transitioning from HIGH to LOW while SCL is HIGH. A STOP condition is defined as SDA transitioning from LOW to HIGH while SCL is HIGH. The I<sup>2</sup>C master always generates the START and STOP conditions. The I<sup>2</sup>C bus is considered busy after a START condition and free after a STOP condition. During data transmission, the I<sup>2</sup>C master can generate repeated START conditions. A START and a repeated START conditions are equivalent function-wise. The data on SDA must be stable during the HIGH period of the clock signal (SCL). In other words, the state of SDA can only be changed when SCL is LOW.

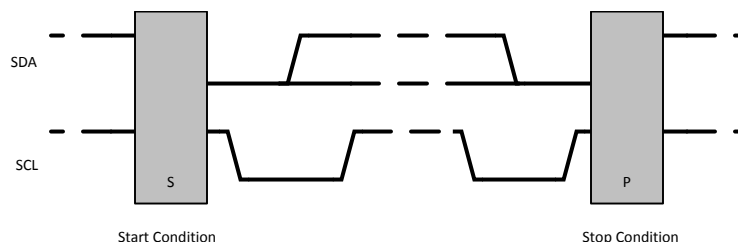

Figure 38. Start and Stop Sequences

#### 8.5.1.2 I<sup>2</sup>C-Compatible Address

The 7-bit chip address for the LM3530 is (0x38, or 0x39) for the 40-V version and (0x36) for the 25-V version. After the START condition, the IC master sends the 7-bit chip address followed by an eighth bit (LSB) read or write (R/W). R/W= 0 indicates a WRITE and R/W = 1 indicates a READ<sup>2</sup>. The second byte following the chip address selects the register address to which the data will be written. The third byte contains the data for the selected register.

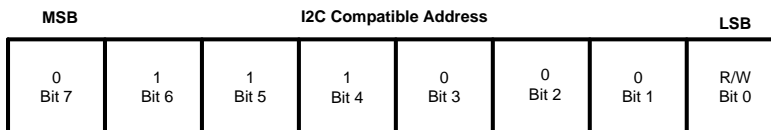

Figure 39. I<sup>2</sup>C-Compatible Chip Address (0x38)

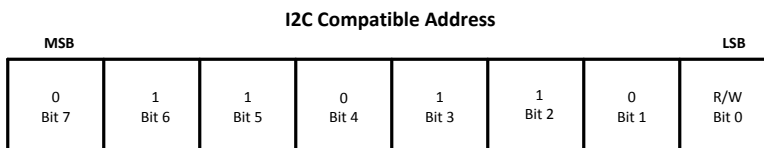

Figure 40. I<sup>2</sup>C-Compatible Chip Address (0x36)

#### 8.5.1.3 Transferring Data

Every byte on the SDA line must be eight bits long, with the most significant bit (MSB) transferred first. Each byte of data must be followed by an acknowledge bit (ACK). The acknowledge related clock pulse (9th clock pulse) is generated by the master. The master then releases SDA (HIGH) during the 9th clock pulse. The LM3530 pulls down SDA during the 9th clock pulse, signifying an acknowledge. An acknowledge is generated after each byte has been received.

There are fourteen 8-bit registers within the LM3530 as detailed in [Table 4](#).

## 8.6 Register Maps

### 8.6.1 Register Descriptions

**Table 4. LM3530 Register Definition**

| REGISTER NAME            | FUNCTION  | ADDRESS | POR VALUE |
|--------------------------|---|---------|-----------|
| General Configuration    | 1. Simple Interface Enable<br>2. PWM Polarity<br>3. PWM enable<br>4. Full-Scale Current Selection<br>5. Brightness Mapping Mode Select<br>6. I <sup>2</sup> C Device Enable | 0x10    | 0xB0      |
| ALS Configuration        | 1. ALS Current Control Enable<br>2. ALS Input Enable<br>3. ALS Input Select<br>4. ALS Averaging Times   | 0x20    | 0x2C      |
| Brightness Ramp Rate     | Programs the rate of rise and fall of the LED current   | 0x30    | 0x00      |
| ALS Zone Information     | 1. Zone Boundary Change Flag<br>2. Zone Brightness Information  | 0x40    | 0x00      |
| ALS Resistor Select      | Internal ALS1 and ALS2 Resistances  | 0x41    | 0x00      |
| Brightness Control (BRT) | Holds the 7 bit Brightness Data   | 0xA0    | 0x7F      |
| Zone Boundary 0 (ZB0)    | ALS Zone Boundary #0  | 0x60    | 0x33      |
| Zone Boundary 1 (ZB1)    | ALS Zone Boundary #1  | 0x61    | 0x66      |
| Zone Boundary 2 (ZB2)    | ALS Zone Boundary #2  | 0x62    | 0x99      |
| Zone Boundary 3 (ZB3)    | ALS Zone Boundary #3  | 0x63    | 0xCC      |
| Zone Target 0 (Z0T)      | Zone 0 LED Current Data. The LED Current Source transitions to the brightness code in Z0T when the ALS_ input is less than the zone boundary programmed in ZB0.             | 0x70    | 0x19      |
| Zone Target 1 (Z1T)      | Zone 1 LED Current Data. The LED Current Source transitions to the brightness code in Z1T when the ALS_ input is between the zone boundaries programmed in ZB1 and ZB0.     | 0x71    | 0x33      |
| Zone Target 2 (Z2T)      | Zone 2 LED Current Data. The LED Current Source transitions to the brightness code in Z2T when the ALS_ input is between the zone boundaries programmed in ZB2 and ZB1.     | 0x72    | 0x4C      |
| Zone Target 3 (Z3T)      | Zone 3 LED Current Data. The LED Current Source transitions to the brightness code in Z3T when the ALS_ input is between the zone boundaries programmed in ZB3 and ZB2.     | 0x73    | 0x66      |
| Zone Target 4 (Z4T)      | Zone 4 LED Current Data. The LED Current Source transitions to the brightness code in Z4T when the ALS_ input is between the zone boundaries programmed in ZB4 and ZB3.     | 0x74    | 0x7F      |

\*Note: Unused bits in the LM3530 Registers default to a logic '1'.

### 8.6.1.1 General Configuration Register (GP)

The General Configuration Register (address 0x10) is described in [Figure 41](#) and [Table 5](#).

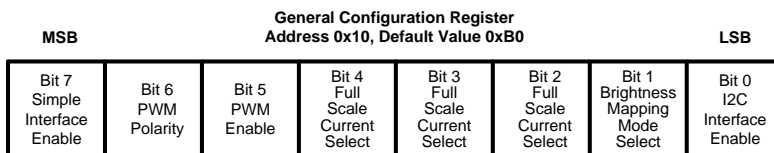

**Figure 41. General Configuration Register**

**Table 5. General Configuration Register Description (0x10)**

| Bit 7<br>(PWM Simple<br>Enable)   | Bit 6<br>(PWM Polarity)                   | Bit 5<br>(EN_PWM)<br>see <a href="#">Figure 31</a>   | Bit 4<br>(Full-Scale<br>Current<br>Select)   | Bit 3<br>(Full-Scale<br>Current<br>Select) | Bit 2<br>(Full-Scale<br>Current<br>Select) | Bit 1<br>(Mapping Mode<br>Select)             | Bit 0<br>(I <sup>2</sup> C Device<br>Enable) |
|---|---|--|--|--|--|---|--|
| 0 = Simple Interface at PWM Input is Disabled<br>1 = Simple Interface at PWM Input is Enabled | 0 = PWM active high<br>1 = PWM active low | 0 = LED current is not a function of PWM duty cycle<br>1 = LED current is a function of duty cycle | 000 = 5 mA full-scale current<br>001 = 8.5 mA full-scale current<br>010 = 12 mA full-scale current<br>011 = 15.5 mA full-scale current<br>100 = 19 mA full-scale current<br>101 = 22.5 mA full-scale current<br>110 = 26 mA full-scale current<br>111 = 29.5 mA full-scale current |  |  | 0 = exponential mapping<br>1 = linear mapping | 0 = Device Disabled<br>1 = Device Enabled    |

### 8.6.1.2 ALS Configuration Register

The ALS Configuration Register controls the Ambient Light Sensing input functions and is described in [Figure 42](#) and [Table 6](#).

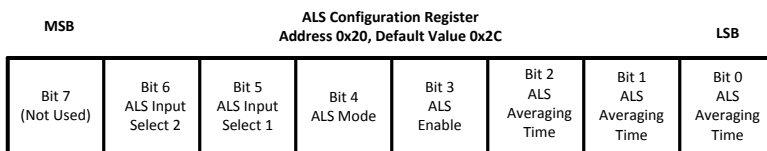

**Figure 42. ALS Configuration Register**

**Table 6. ALS Configuration Register Description (0x20)**

| Bit 7 | Bit 6<br>ALS Input<br>Select   | Bit 5<br>ALS Input<br>Select | Bit 4<br>ALS Enable   | Bit 3<br>ALS Enable | Bit 2<br>ALS<br>Averaging<br>Time   | Bit 1<br>ALS<br>Averaging<br>Time | Bit 0<br>ALS<br>Averaging<br>Time |
|-------|--|------------------------------|---|---------------------|---|-----------------------------------|-----------------------------------|
| N/A   | 00 = The Average of ALS1 and ALS2 is used to control the LED brightness<br>01 = ALS1 is used to control the LED brightness<br>10 = ALS2 is used to control the LED brightness<br>11 = The ALS input with the highest voltage is used to control the LED brightness |                              | 00 or 10 = ALS is <b>disabled</b> . The Brightness Register is used to determine the LED current.<br>01 = ALS is <b>enabled</b> . The Brightness Register is used to determine the LED Current.<br>11 = ALS inputs are <b>enabled</b> . Ambient light determines the LED current. |                     | 000 = 32 ms<br>001 = 64 ms<br>010 = 128 ms<br>011 = 256 ms<br>100 = 512 ms<br>101 = 1024 ms<br>110 = 2048 ms<br>111 = 4096 ms |                                   |                                   |

### 8.6.1.3 Brightness Ramp Rate Register

The Brightness Ramp Rate Register controls the rate of rise or fall of the LED current. Both the rising rate and falling rate are independently adjustable [Figure 43](#) and [Table 7](#) describe the bit settings.

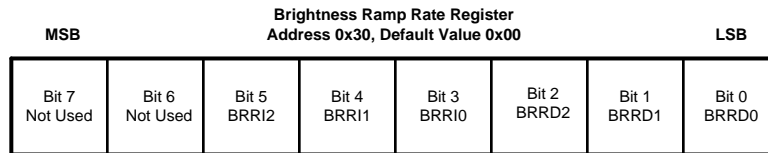

**Figure 43. Brightness Ramp Rate Register**

**Table 7. Brightness Ramp Rate Register Description (0x30)**

| Bit 7 | Bit 6 | Bit 5<br>(BRR12)  | Bit 4<br>(BRR11) | Bit 3<br>(BRR10) | Bit 2<br>(BRRD2)  | Bit 1<br>(BRRD1) | Bit 0<br>(BRRD0) |
|-------|-------|---|------------------|------------------|---|------------------|------------------|
| N/A   | N/A   | 000 = 8 µs/step (1.106 ms from 0 to Full Scale)<br>001 = 1.024 ms/step (130 ms from 0 to Full Scale)<br>010 = 2.048 ms/step (260 ms from 0 to Full Scale)<br>011 = 4.096 ms/step (520 ms from 0 to Full Scale)<br>100 = 8.192 ms/step (1.04 s from 0 to Full Scale)<br>101 = 16.384 ms/step (2.08 s from 0 to Full Scale)<br>110 = 32.768 ms/step (4.16 s from 0 to Full Scale)<br>111 = 65.538 ms/step (8.32 s from 0 to Full Scale) |                  |                  | 000 = 8 µs/step (1.106 ms from Full Scale to 0)<br>001 = 1.024 ms/step (130 ms from Full Scale to 0)<br>010 = 2.048 ms/step (260 ms from Full Scale to 0)<br>011 = 4.096 ms/step (520 ms from Full Scale to 0)<br>100 = 8.192 ms/step (1.04 s from Full Scale to 0)<br>101 = 16.384 ms/step (2.08 s from Full Scale to 0)<br>110 = 32.768 ms/step (4.16 s from Full Scale to 0)<br>111 = 65.538 ms/step (8.32 s from Full Scale to 0) |                  |                  |

### 8.6.1.4 ALS Zone Information Register

The ALS Zone Information Register is a read-only register that is updated every time the active ALS input(s) detect that the ambient light has changed to a new zone as programmed in the Zone Boundary Registers. See [Zone Boundary Register](#) description. A new update to the ALS Zone Information Register is signaled by the INT output going from high to low. A read-back of the ALS Zone Information Register will cause the INT output to go open-drain again. The Zone Change Flag (bit 3) is also updated on a Zone change and cleared on a read back of the ALS Zone Information Register. [Figure 44](#) and [Table 8](#) detail the ALS Zone Information Register.

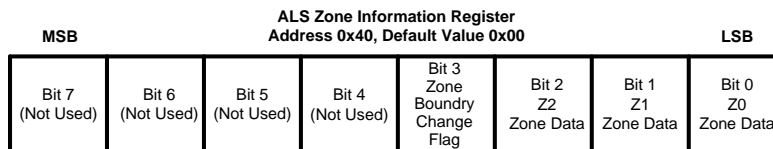

**Figure 44. ALS Zone Information Register**

**Table 8. ALS Zone Information Register Description (0x40)**

| Bit 7 | Bit 6 | Bit 5 | Bit 4 | Bit 3<br>(Zone Boundary Change Flag)  | Bit 2<br>(Z2)  | Bit 1<br>(Z1) | Bit 0<br>(Z0) |
|-------|-------|-------|-------|---|--|---------------|---------------|
| N/A   | N/A   | N/A   | N/A   | 1 = the active ALS input has changed to a new ambient light zone as programmed in the Zone Boundary Registers (ZB0-ZB3)<br>0 = no zone change | 000 = Zone 0<br>001 = Zone 1<br>010 = Zone 2<br>011 = Zone 3<br>100 = Zone 4 |               |               |

### 8.6.1.5 ALS Resistor Select Register

The ALS Resistor Select Register configures the internal resistance from either the ALS1 or ALS2 input to GND. Bits [3:0] program the input resistance at the ALS1 input and bits [7:4] program the input resistance at the ALS2 input. With bits [3:0] set to all zeroes the ALS1 input is high impedance. With bits [7:4] set to all zeroes the ALS2 input is high impedance.

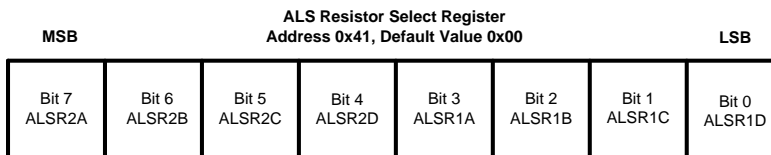

Figure 45. ALS Resistor Select Register

Table 9. ALS Resistor Select Register Description (0x41)

| Bit 7<br>(ALSR2A)   | Bit 6<br>(ALSR2B) | Bit 5<br>(ALSR2C) | Bit 4<br>(ALSR2D) | Bit 3<br>(ALSR1A)   | Bit 2<br>(ALSR1B) | Bit 1<br>(ALSR1C) | Bit 0<br>(ALSR1D) |
|---|-------------------|-------------------|-------------------|---|-------------------|-------------------|-------------------|
| 0000 = ALS2 is high impedance<br>0001 = 13.531 kΩ (73.9 μA at 1 V)<br>0010 = 9.011 kΩ (111 μA at 1 V)<br>0011 = 5.4116 kΩ (185 μA at 1 V)<br>0100 = 2.271 kΩ (440 μA at 1 V)<br>0101 = 1.946 kΩ (514 μA at 1 V)<br>0110 = 1.815 kΩ (551 μA at 1 V)<br>0111 = 1.6 kΩ (625 μA at 1 V)<br>1000 = 1.138 kΩ (879 μA at 1 V)<br>1001 = 1.05 kΩ (952 μA at 1 V)<br>1010 = 1.011 kΩ (989 μA at 1 V)<br>1011 = 941 Ω (1.063 mA at 1 V)<br>1100 = 759 Ω (1.318 mA at 1 V)<br>1101 = 719 Ω (1.391 mA at 1 V)<br>1110 = 700 Ω (1.429 mA at 1 V)<br>1111 = 667 Ω (1.499 mA at 1 V) |                   |                   |                   | 0000 = ALS2 is high impedance<br>0001 = 13.531 kΩ (73.9 μA at 1 V)<br>0010 = 9.011 kΩ (111 μA at 1 V)<br>0011 = 5.4116 kΩ (185 μA at 1 V)<br>0100 = 2.271 kΩ (440 μA at 1 V)<br>0101 = 1.946 kΩ (514 μA at 1 V)<br>0110 = 1.815 kΩ (551 μA at 1 V)<br>0111 = 1.6 kΩ (625 μA at 1 V)<br>1000 = 1.138 kΩ (879 μA at 1 V)<br>1001 = 1.05 kΩ (952 μA at 1 V)<br>1010 = 1.011 kΩ (989 μA at 1 V)<br>1011 = 941 Ω (1.063 mA at 1 V)<br>1100 = 759 Ω (1.318 mA at 1 V)<br>1101 = 719 Ω (1.391 mA at 1 V)<br>1110 = 700 Ω (1.429 mA at 1 V)<br>1111 = 667 Ω (1.499 mA at 1 V) |                   |                   |                   |

8.6.1.6 Brightness Control Register

The Brightness Register (BRT) is an 8-bit register that programs the 127 different LED current levels (Bits [6:0]). The code written to BRT is translated into an LED current as a percentage of  $I_{LED\_FULLSCALE}$  as set via the Full-Scale Current Select bits (General Configuration Register bits [4:2]). The LED current response has a typical 1000:1 dimming ratio at the maximum full-scale current (General Configuration Register bits [4:2] = (111) and using the exponential weighted dimming curve.

There are two selectable LED current profiles. Setting the General Configuration Register bit 1 to 0 selects the exponentially weighted LED current response (see Figure 34). Setting this bit to '1' selects the linear weighted curve (see Figure 35). Table 2 and Table 3 show the percentage Full-Scale LED Current at a given Brightness Register Code for both the Exponential and Linear current response.

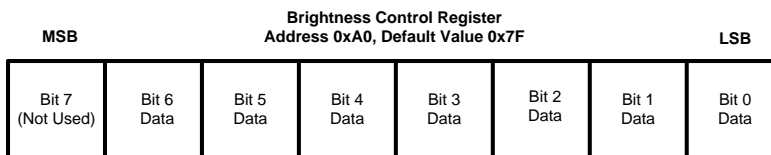

Figure 46. Brightness Control Register

Table 10. Brightness Control Register Description (0xA0)

| Bit 7<br>N/A                      | Bit 6<br>Data (MSB) | Bit 5<br>Data | Bit 4<br>Data | Bit 3<br>Data                 | Bit 2<br>Data | Bit 1<br>Data | Bit 0<br>Data |
|-----------------------------------|---------------------|---------------|---------------|-------------------------------|---------------|---------------|---------------|
| LED Brightness Data (Bits [6:0])  |                     |               |               |                               |               |               |               |
| Exponential Mapping (see Table 2) |                     |               |               | Linear Mapping (see Table 3)  |               |               |               |
| 0000000 = LEDs Off                |                     |               |               | 0000000 = LEDs Off            |               |               |               |
| 0000001 = 0.08% of Full Scale     |                     |               |               | 0000001 = 0.79% of Full Scale |               |               |               |
| :                                 |                     |               |               | :                             |               |               |               |
| :                                 |                     |               |               | :                             |               |               |               |
| :                                 |                     |               |               | :                             |               |               |               |
| 1111111 = 100% of Full Scale      |                     |               |               | 1111111 = 100% of Full Scale  |               |               |               |

### 8.6.1.7 Zone Boundary Register

The Zone Boundary Registers are programmed with the ambient light sensing zone boundaries. The default values are set at 20% (200 mV), 40% (400 mV), 60% (600 mV), and 80% (800 mV) of the full-scale ALS input voltage range (1V). The necessary conditions for proper ALS operation are that the data in ZB0 < data in ZB1 < data in ZB2 < data in ZB3.

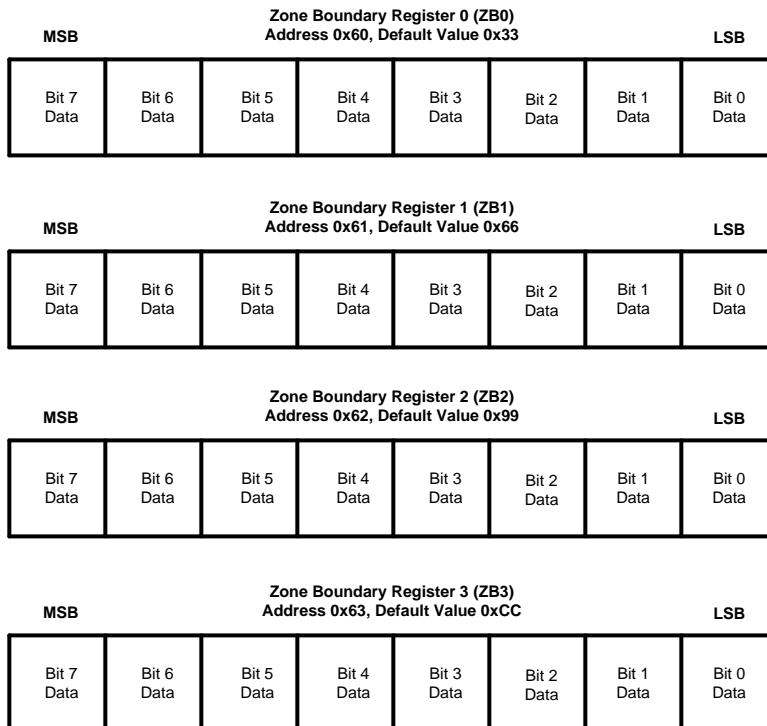

**Figure 47. Zone Boundary Registers**

### 8.6.1.8 Zone Target Registers

The Zone Target Registers contain the LED brightness data that corresponds to the current active ALS zone. The default values for these registers and their corresponding percentage of full-scale current for both linear and exponential brightness is shown in [Figure 48](#) and [Table 11](#).

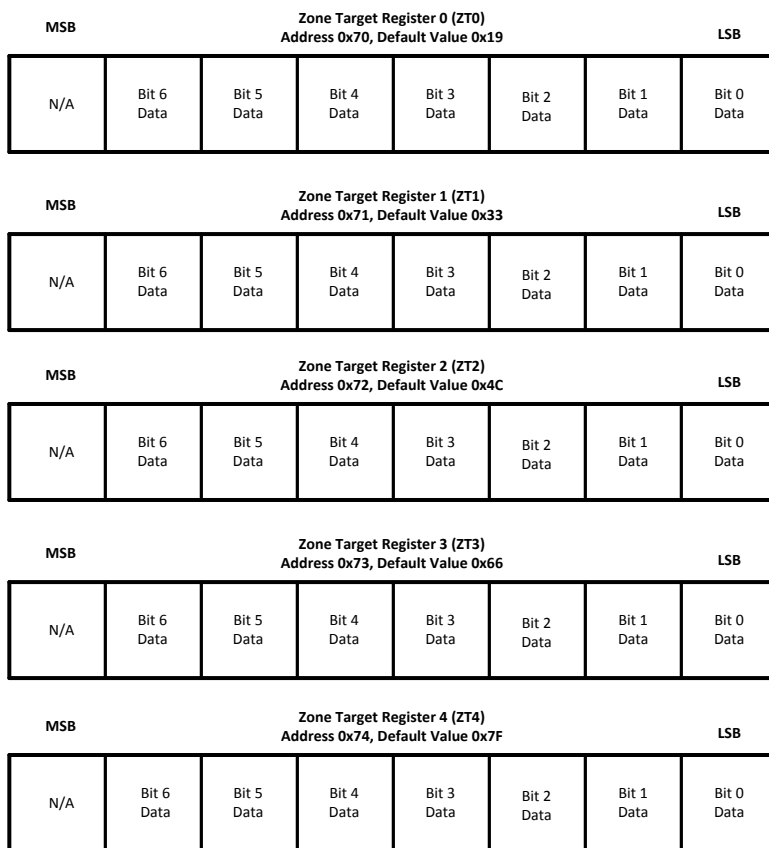
**Figure 48. Zone Target Registers**
**Table 11. Zone Boundary and Zone Target Default Mapping**

| ZONE BOUNDARY<br>(DEFAULT)                                   | ZONE TARGET<br>REGISTER<br>(DEFAULT) | FULL-SCALE<br>CURRENT<br>(DEFAULT) | LINEAR MAPPING<br>(DEFAULT) | EXPONENTIAL<br>MAPPING<br>(DEFAULT) |
|--|--------------------------------------|------------------------------------|-----------------------------|-------------------------------------|
| Boundary 0,<br>Active ALS input is less than 200 mV          | 0x19                                 | 19 mA                              | 19.69% (3.74 $\mu$ A)       | 0.336% (68.4 $\mu$ A)               |
| Boundary 1,<br>Active ALS input is between 200 mV and 400 mV | 0x33                                 | 19 mA                              | 40.16% (7.63 $\mu$ A)       | 1.43% (272 $\mu$ A)                 |
| Boundary 2,<br>Active ALS input is between 400 mV and 600 mV | 0x4C                                 | 19 mA                              | 59.84% (11.37 mA)           | 5.78% (1.098 mA)                    |
| Boundary 3,<br>Active ALS input is between 600 mV and 800 mV | 0x66                                 | 19 mA                              | 80.31% (15.26 mA)           | 24.84% (4.72 mA)                    |
| Boundary 4,<br>Active ALS input is greater than 800mV        | 0x7F                                 | 19 mA                              | 100% (19 mA)                | 100% (19 mA)                        |

## 9 Application and Implementation

### NOTE

Information in the following applications sections is not part of the TI component specification, and TI does not warrant its accuracy or completeness. TI's customers are responsible for determining suitability of components for their purposes. Customers should validate and test their design implementation to confirm system functionality.

### 9.1 Application Information

The LM3530 incorporates a 40-V (maximum output) boost, a single current sink, and a dual ambient light sensor interface. The maximum boost output voltage is 40 V (min) for the LM3530-40 version. The LM3530 boost will drive the output voltage to whatever voltage necessary to maintain 400mV at the ILED input. The 40-V max output typically allows the LM3530 to drive from 2 series up to 12 series LEDs (3.2V max voltage per LED). For applications that do not use one or both of the ALS inputs, the ALS input can be connected to GND or left floating.

### 9.2 Typical Application

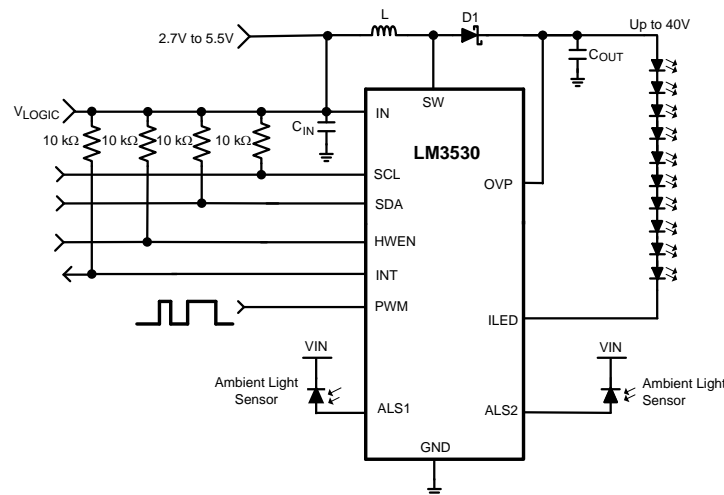

Figure 49. LM3530 Typical Application

#### 9.2.1 Design Requirements

Example requirements for typical voltage inverter applications:

Table 12. Design Parameters

| DESIGN PARAMETER          | EXAMPLE VALUE  |
|---------------------------|----------------|
| Input voltage range       | 2.7 V to 5.5 V |
| Output current            | 0 mA to 30 mA  |
| Boost switching frequency | 500 kHz        |

Table 13. Application Circuit Component List

| COMPONENT | MANUFACTURER | PART NUMBER       | VALUE                | SIZE                     | CURRENT/VOLTAGE RATING |
|-----------|--------------|-------------------|----------------------|--------------------------|------------------------|
| L         | TDK          | VLF3014ST100MR82  | 10 $\mu$ H           | 3 mm x 3 mm x 1.4 mm     | $I_{SAT} = 820$ mA     |
| COUT      | Murata       | GRM21BR71H105KA12 | 1 $\mu$ F            | 0805                     | 50 V                   |
| CIN       | Murata       | GRM188B31A225KE33 | 2.2 $\mu$ F          | 0603                     | 10 V                   |
| D1        | Diodes Inc.  | B0540WS           | Schottky             | SOD-323                  | 40 V/500 mA            |
| ALS1      | Avago        | APDS-9005         | Ambient Light Sensor | 1.6 mm x 1.5 mm x 0.6 mm | 0 to 1100 Lux          |
| ALS2      | Avago        | APDS-9005         | Ambient Light Sensor | 1.6 mm x 1.5 mm x 0.6 mm | 0 to 1100 Lux          |

## 9.2.2 Detailed Design Procedure

### 9.2.2.1 LED Current Setting/Maximum LED Current

The maximum LED current is restricted by the following factors: the maximum duty cycle that the boost converter can achieve, the peak current limitations, and the maximum output voltage.

### 9.2.2.2 Maximum Duty Cycle

The LM3530 can achieve up to typically 94% maximum duty cycle. Two factors can cause the duty cycle to increase: an increase in the difference between  $V_{OUT}$  and  $V_{IN}$  and a decrease in efficiency. This is shown by Equation 12:

$$D = 1 - \frac{V_{IN} \times \eta}{V_{OUT}} \quad (12)$$

For a 9-LED configuration  $V_{OUT} = (3.6 \text{ V} \times 9_{LED} + V_{HR}) = 33 \text{ V}$  operating with  $\eta = 70\%$  from a 3-V battery, the duty cycle requirement would be around 93.6%. Lower efficiency or larger  $V_{OUT}$  to  $V_{IN}$  differentials can push the duty cycle requirement beyond 94%.

### 9.2.2.3 Peak Current Limit

The LM3530 boost converter has a peak current limit for the internal power switch of 839 mA typical (739 mA minimum). When the peak switch current reaches the current limit, the duty cycle is terminated resulting in a limit on the maximum output current and thus the maximum output power the LM3530 can deliver. Calculate the maximum LED current as a function of  $V_{IN}$ ,  $V_{OUT}$ ,  $L$ , efficiency ( $\eta$ ) and  $I_{PEAK}$  as:

$$I_{OUT\_MAX} = \frac{(I_{PEAK} - \Delta I_L) \times \eta \times V_{IN}}{V_{OUT}}$$

$$\text{where } \Delta I_L = \frac{V_{IN} \times (V_{OUT} - V_{IN})}{2 \times f_{SW} \times L \times V_{OUT}}$$

where

- $f_{SW} = 500 \text{ kHz}$
- $\eta$  and  $I_{PEAK}$  can be found in the Efficiency and  $I_{PEAK}$  curves in the [Specifications](#) and [Application Curves](#). (13)

### 9.2.2.4 Output Voltage Limitations

The LM3530 has a maximum output voltage of 41 V typical (40 V minimum) for the LM3530-40 version and 24 V typical (23.6 V minimum) for the LM3530-25 version. When the output voltage rises above this threshold ( $V_{OVP}$ ) the overvoltage protection feature is activated and the duty cycle is terminated. Switching will cease until  $V_{OUT}$  drops below the hysteresis level (typically 1 V below  $V_{OVP}$ ). For larger numbers of series connected LEDs the output voltage can reach the OVP threshold at larger LED currents and colder ambient temperatures. Typically white LEDs have a  $-3\text{mV}/^\circ\text{C}$  temperature coefficient.

### 9.2.2.5 Output Capacitor Selection

The LM3530's output capacitor has two functions: filtering of the boost converters switching ripple, and to ensure feedback loop stability. As a filter, the output capacitor supplies the LED current during the boost converters on time and absorbs inductor energy during the switch off time. This causes a sag in the output voltage during the on time and a rise in the output voltage during the off time. Because of this, the output capacitor must be sized large enough to filter the inductor current ripple that could cause the output voltage ripple to become excessive. As a feedback loop component, the output capacitor must be at least 1  $\mu\text{F}$  and have low ESR otherwise the LM3530 boost converter can become unstable. This requires the use of ceramic output capacitors. Table 14 lists part numbers and voltage ratings for different output capacitors that can be used with the LM3530.

**Table 14. Recommended Input/Output Capacitors**

| MANUFACTURER | PART NUMBER       | VALUE ( $\mu\text{F}$ ) | SIZE | RATING (V) | DESCRIPTION |
|--------------|-------------------|-------------------------|------|------------|-------------|
| Murata       | GRM21BR71H105KA12 | 1                       | 0805 | 50         | COUT        |
| Murata       | GRM188B31A225KE33 | 2.2                     | 0805 | 10         | CIN         |
| TDK          | C1608X5R0J225     | 2.2                     | 0603 | 6.3        | CIN         |

### 9.2.2.6 Inductor Selection

The LM3530 is designed to work with a 10- $\mu\text{H}$  to 22- $\mu\text{H}$  inductor. When selecting the inductor, ensure that the saturation rating for the inductor is high enough to accommodate the peak inductor current. [Equation 14](#) and [Equation 15](#) calculate the peak inductor current based upon LED current,  $V_{\text{IN}}$ ,  $V_{\text{OUT}}$ , and efficiency.

$$I_{\text{PEAK}} = \frac{I_{\text{LED}}}{\eta} \times \frac{V_{\text{OUT}}}{V_{\text{IN}}} + \Delta I_L \quad (14)$$

where:

$$\Delta I_L = \frac{V_{\text{IN}} \times (V_{\text{OUT}} - V_{\text{IN}})}{2 \times f_{\text{SW}} \times L \times V_{\text{OUT}}} \quad (15)$$

When choosing L, the inductance value must also be large enough so that the peak inductor current is kept below the LM3530 switch current limit. This forces a lower limit on L given by [Equation 16](#).

$$L > \frac{V_{\text{IN}} \times (V_{\text{OUT}} - V_{\text{IN}})}{2 \times f_{\text{SW}} \times V_{\text{OUT}} \times \left( I_{\text{SW\_MAX}} - \frac{I_{\text{LED\_MAX}} \times V_{\text{OUT}}}{\eta \times V_{\text{IN}}} \right)} \quad (16)$$

$I_{\text{SW\_MAX}}$  is given in , efficiency ( $\eta$ ) is shown in the [Application Curves](#), and  $f_{\text{SW}}$  is typically 500 kHz.

**Table 15. Suggested Inductors**

| MANUFACTURER | PART NUMBER         | VALUE ( $\mu\text{H}$ ) | SIZE (mm)         | RATING (mA) | DC RESISTANCE ( $\Omega$ ) |
|--------------|---------------------|-------------------------|-------------------|-------------|----------------------------|
| TDK          | VLF3014ST-100MR82   | 10                      | 2.8 × 3 × 1.4     | 820         | 0.25                       |
| TDK          | VLF3010ST-220MR34   | 22                      | 2.8 × 3 × 1       | 340         | 0.81                       |
| TDK          | VLF3010ST-100MR53   | 10                      | 2.8 × 3 × 1       | 530         | 0.41                       |
| TDK          | VLF4010ST-100MR80   | 10                      | 2.8 × 3 × 1       | 800         | 0.25                       |
| TDK          | VLS252010T-100M     | 10                      | 2.5 × 2 × 1       | 650         | 0.71                       |
| Coilcraft    | LPS3008-103ML       | 10                      | 2.95 × 2.95 × 0.8 | 520         | 0.65                       |
| Coilcraft    | LPS3008-223ML       | 22                      | 2.95 × 2.95 × 0.8 | 340         | 1.5                        |
| Coilcraft    | LPS3010-103ML       | 10                      | 2.95 × 2.95 × 0.9 | 550         | 0.54                       |
| Coilcraft    | LPS3010-223ML       | 22                      | 2.95 × 2.95 × 0.9 | 360         | 1.2                        |
| Coilcraft    | XPL2010-103ML       | 10                      | 1.9 × 2 × 1       | 610         | 0.56                       |
| Coilcraft    | EPL2010-103ML       | 10                      | 2 × 2 × 1         | 470         | 0.91                       |
| TOKO         | DE2810C-1117AS-100M | 10                      | 3 × 3.2 × 1       | 600         | 0.46                       |

### 9.2.2.7 Diode Selection

The diode connected between SW and OUT must be a Schottky diode and have a reverse breakdown voltage high enough to handle the maximum output voltage in the application. [Table 16](#) lists various diodes that can be used with the LM3530. For 25-V OVP devices a 30-V Schottky is adequate. For 40-V OVP devices, a 40-V Schottky diode should be used.

**Table 16. Suggested Diodes**

| MANUFACTURER     | PART NUMBER  | VALUE    | SIZE (mm)                 | RATING      |
|------------------|--------------|----------|---------------------------|-------------|
| Diodes Inc       | B0540WS      | Schottky | SOD-323 (1.7 × 1.3)       | 40 V/500 mA |
| Diodes Inc       | SDM20U40     | Schottky | SOD-523 (1.2 × 0.8 × 0.6) | 40 V/200 mA |
| On Semiconductor | NSR0340V2T1G | Schottky | SOD-523 (1.2 × 0.8 × 0.6) | 40 V/250 mA |
| On Semiconductor | NSR0240V2T1G | Schottky | SOD-523 (1.2 × 0.8 × 0.6) | 40 V/250 mA |

9.2.3 Application Curves

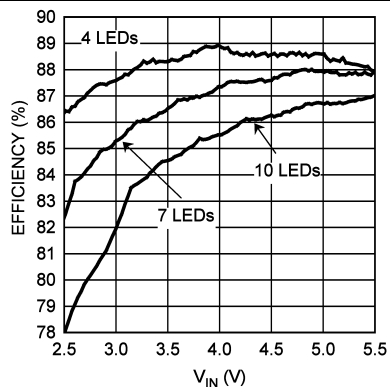

$I_{FULL\_SCALE} = 19\text{ mA}$

Figure 50. Efficiency vs  $V_{IN}$

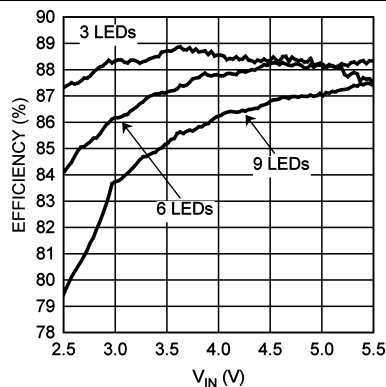

$I_{FULL\_SCALE} = 19\text{ mA}$

Figure 51. Efficiency vs  $V_{IN}$

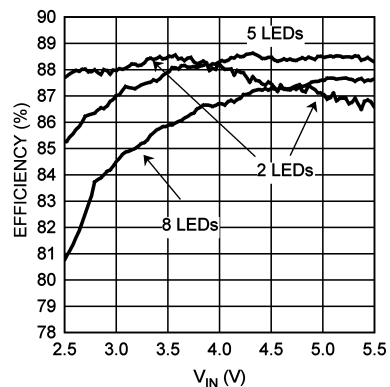

$I_{FULL\_SCALE} = 19\text{ mA}$

Figure 52. Efficiency vs  $V_{IN}$

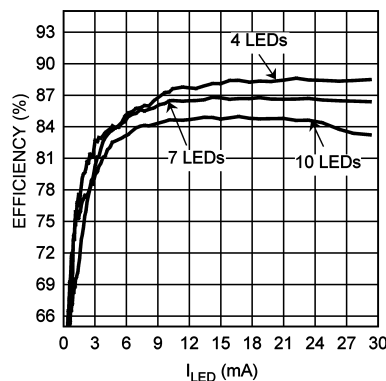

Figure 53. Efficiency vs  $I_{LED}$

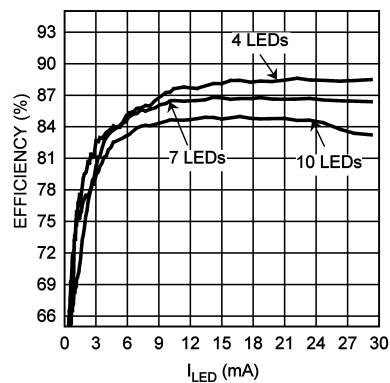

Figure 54. Efficiency vs  $I_{LED}$

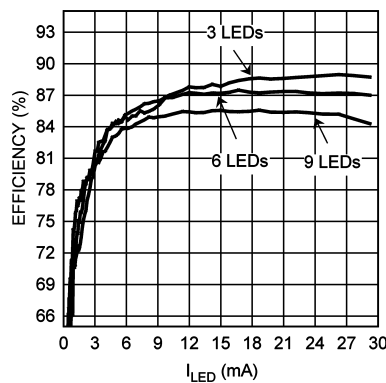

Figure 55. Efficiency vs  $I_{LED}$

## 10 Power Supply Recommendations

The LM3530 operates from a 2.7-V to 5.5-V input voltage. The 500-kHz switching frequency for the boost can lead to ripple voltage on the input voltage rail. To minimize this, the input to the inductor should be well bypassed with a 1- $\mu$ F (min) ceramic bypass capacitor (see [Output Capacitor Selection](#)).

## 11 Layout

### 11.1 Layout Guidelines

The LM3530 contains an inductive boost converter which detects a high switched voltage (up to 40 V) at the SW pin, and a step current (up to 900 mA) through the Schottky diode and output capacitor each switching cycle. The high switching voltage can create interference into nearby nodes due to electric field coupling ( $I = CdV/dt$ ). The large step current through the diode and the output capacitor can cause a large voltage spike at the SW pin and the OVP pin due to parasitic inductance in the step current conducting path ( $V = Ldi/dt$ ). Board layout guidelines are geared towards minimizing this electric field coupling and conducted noise. [Figure 56](#) highlights these two noise generating components.

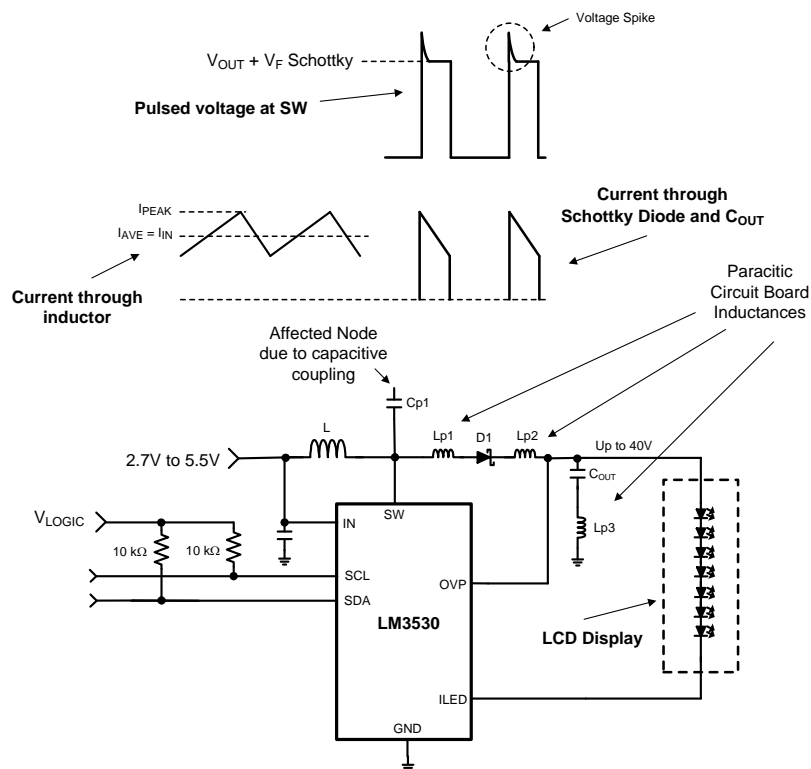

**Figure 56. LM3530 Boost Converter Showing Pulsed Voltage At SW (High  $Dv/Dt$ ) and Current Through Schottky and  $C_{OUT}$  (High  $Di/Dt$ )**

## Layout Guidelines (continued)

The following lists the main (layout sensitive) areas of the LM3530 in order of decreasing importance:

- Output Capacitor
  - Schottky Cathode to  $C_{OUT+}$
  - $C_{OUT-}$  to GND
- Schottky Diode
  - SW Pin to Schottky Anode
  - Schottky Cathode to  $C_{OUT+}$
- Inductor
  - SW Node PCB capacitance to other traces
- Input Capacitor
  - $C_{IN+}$  to IN pin
  - $C_{IN-}$  to GND

### 11.1.1 Output Capacitor Placement

The output capacitor is in the path of the inductor current discharge path. As a result  $C_{OUT}$  detects a high current step from 0 to  $I_{PEAK}$  each time the switch turns off and the Schottky diode turns on. Any inductance along this series path from the cathode of the diode through  $C_{OUT}$  and back into the LM3530 GND pin will contribute to voltage spikes ( $V_{SPIKE} = L_P \times di/dt$ ) at SW and OUT which can potentially overvoltage the SW pin, or feed through to GND. To avoid this,  $C_{OUT+}$  must be connected as close as possible to the Cathode of the Schottky diode and  $C_{OUT-}$  must be connected as close as possible to the device GND bump. The best placement for  $C_{OUT}$  is on the same layer as the LM3530 so as to avoid any vias that can add excessive series inductance (see [Figure 58](#), [Figure 59](#), and [Figure 60](#)).

### 11.1.2 Schottky Diode Placement

The Schottky diode is in the path of the inductor current discharge. As a result the Schottky diode detects a high current step from 0 to  $I_{PEAK}$  each time the switch turns off and the diode turns on. Any inductance in series with the diode will cause a voltage spike ( $V_{SPIKE} = L_P \times di/dt$ ) at SW and OUT which can potentially overvoltage the SW pin, or feed through to  $V_{OUT}$  and through the output capacitor and into GND. Connecting the anode of the diode as close as possible to the SW pin and the cathode of the diode as close as possible to  $C_{OUT+}$  will reduce the inductance ( $L_P$ ) and minimize these voltage spikes (see [Figure 58](#), [Figure 59](#), and [Figure 60](#)).

### 11.1.3 Inductor Placement

The node where the inductor connects to the LM3530 SW bump has 2 issues. First, a large switched voltage (0 to  $V_{OUT} + V_{F\_SCHOTTKY}$ ) appears on this node every switching cycle. This switched voltage can be capacitively coupled into nearby nodes. Second, there is a relatively large current (input current) on the traces connecting the input supply to the inductor and connecting the inductor to the SW bump. Any resistance in this path can cause large voltage drops that will negatively affect efficiency.

To reduce the capacitively coupled signal from SW into nearby traces, the SW bump to inductor connection must be minimized in area. This limits the PCB capacitance from SW to other traces. Additionally, the other traces need to be routed away from SW and not directly beneath. This is especially true for high impedance nodes that are more susceptible to capacitive coupling such as (SCL, SDA, HWEN, PWM, and possibly ASL1 and ALS2). A GND plane placed directly below SW will dramatically reduce the capacitive coupling from SW into nearby traces

To limit the trace resistance of the VBATT to inductor connection and from the inductor to SW connection, use short, wide traces (see [Figure 58](#), [Figure 59](#), and [Figure 60](#)).

### 11.1.4 Input Capacitor Selection and Placement

The input bypass capacitor filters the inductor current ripple, and the internal MOSFET driver currents during turn on of the power switch.

## Layout Guidelines (continued)

The driver current requirement can range from 50 mA at 2.7 V to over 200 mA at 5.5 V with fast durations of approximately 10 ns to 20 ns. This will appear as high di/dt current pulses coming from the input capacitor each time the switch turns on. Close placement of the input capacitor to the IN pin and to the GND pin is critical since any series inductance between IN and C<sub>IN+</sub> or C<sub>IN-</sub> and GND can create voltage spikes that could appear on the V<sub>IN</sub> supply line and in the GND plane.

Close placement of the input bypass capacitor at the input side of the inductor is also critical. The source impedance (inductance and resistance) from the input supply, along with the input capacitor of the LM3530, form a series RLC circuit. If the output resistance from the source (R<sub>S</sub>) is low enough the circuit will be underdamped and will have a resonant frequency (typically the case). Depending on the size of L<sub>S</sub> the resonant frequency could occur below, close to, or above switching frequency of the device. This can cause the supply current ripple to be:

1. Approximately equal to the inductor current ripple when the resonant frequency occurs well above the LM3530 switching frequency;
2. Greater than the inductor current ripple when the resonant frequency occurs near the switching frequency; and
3. Less than the inductor current ripple when the resonant frequency occurs well below the switching frequency.

[Figure 57](#) shows the series RLC circuit formed from the output impedance of the supply and the input capacitor. The circuit is re-drawn for the AC case where the V<sub>IN</sub> supply is replaced with a short to GND and the LM3530 + Inductor is replaced with a current source (ΔI<sub>L</sub>). In [Figure 57](#) below,

1. = the criteria for an underdamped response.
2. = the resonant frequency, and
3. = the approximated supply current ripple as a function of L<sub>S</sub>, R<sub>S</sub>, and C<sub>IN</sub>.

As an example, consider a 3.6-V supply with 0.1-Ω of series resistance connected to C<sub>IN</sub> through 50 nH of connecting traces. This results in an underdamped input filter circuit with a resonant frequency of 712 kHz. Since the switching frequency lies near to the resonant frequency of the input RLC network, the supply current is probably larger than the inductor current ripple. In this case using [Equation 2](#) from [Figure 57](#) the supply current ripple can be approximated as 1.68 multiplied by the inductor current ripple. Increasing the series inductance (L<sub>S</sub>) to 500 nH causes the resonant frequency to move to around 225 kHz and the supply current ripple to be approximately 0.25 multiplied by the inductor current ripple.

Layout Guidelines (continued)

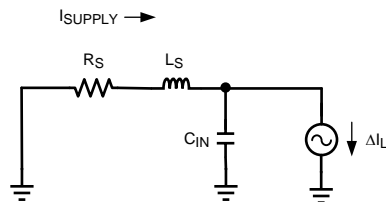
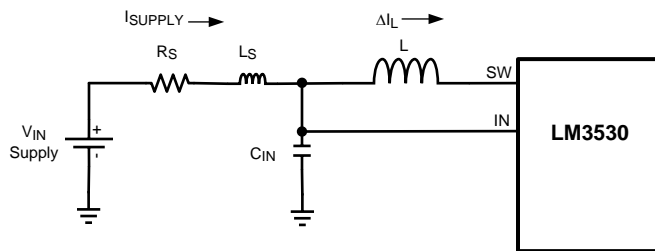

1.  $\frac{1}{L_S \times C_{IN}} > \frac{R_S^2}{4 \times L_S^2}$
2.  $f_{RESONANT} = \frac{1}{2\pi \sqrt{L_S \times C_{IN}}}$
3.  $I_{SUPPLYRIPPLE} \approx \Delta I_L \times \frac{1}{\sqrt{R_S^2 + \left(2\pi \times 500 \text{ kHz} \times L_S - \frac{1}{2\pi \times 500 \text{ kHz} \times C_{IN}}\right)^2}}$

Figure 57. Input RLC Network

11.2 Layout Example

Figure 58, Figure 59, and Figure 60 show example layouts which apply the required proper layout guidelines. These figures should be used as guides for laying out the LM3530 circuit.

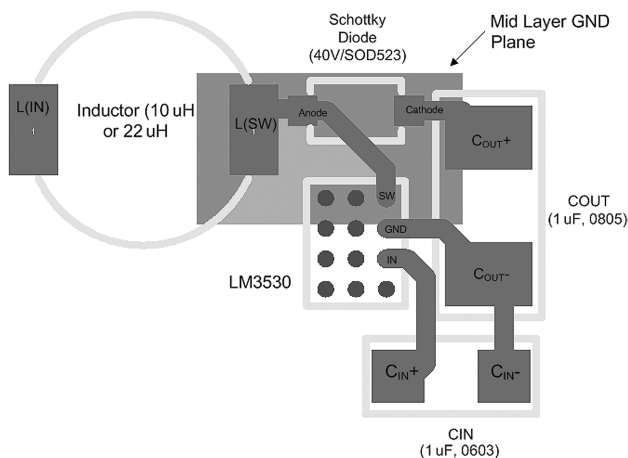
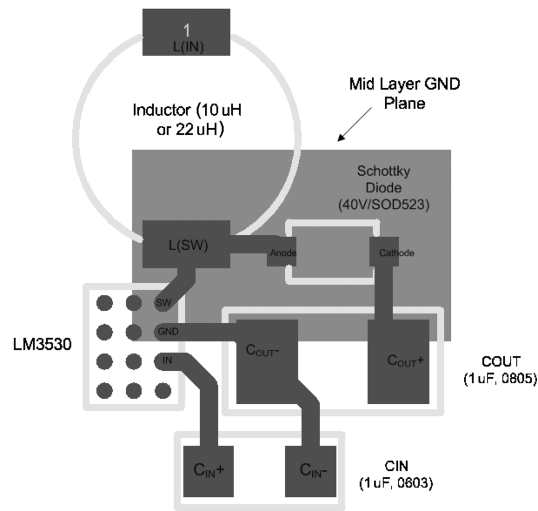
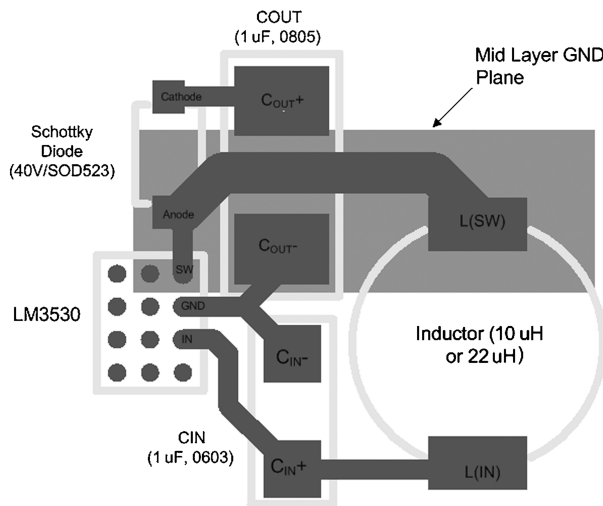

Figure 58. Layout Example 1

**Layout Example (continued)**



**Figure 59. Layout Example 2**



**Figure 60. Layout Example 3**

## 12 Device and Documentation Support

### 12.1 Device Support

#### 12.1.1 Third-Party Products Disclaimer

TI'S PUBLICATION OF INFORMATION REGARDING THIRD-PARTY PRODUCTS OR SERVICES DOES NOT CONSTITUTE AN ENDORSEMENT REGARDING THE SUITABILITY OF SUCH PRODUCTS OR SERVICES OR A WARRANTY, REPRESENTATION OR ENDORSEMENT OF SUCH PRODUCTS OR SERVICES, EITHER ALONE OR IN COMBINATION WITH ANY TI PRODUCT OR SERVICE.

### 12.2 Documentation Support

#### 12.2.1 Related Documentation

For related documentation, see the following:

Texas Instruments Application Note 1112: *DSBGA Wafer Level Chip Scale Package* ([SNVA009](#)).

### 12.3 Trademarks

All trademarks are the property of their respective owners.

### 12.4 Electrostatic Discharge Caution



This integrated circuit can be damaged by ESD. Texas Instruments recommends that all integrated circuits be handled with appropriate precautions. Failure to observe proper handling and installation procedures can cause damage.

ESD damage can range from subtle performance degradation to complete device failure. Precision integrated circuits may be more susceptible to damage because very small parametric changes could cause the device not to meet its published specifications.

### 12.5 Glossary

[SLYZ022](#) — *TI Glossary*.

This glossary lists and explains terms, acronyms, and definitions.

## 13 Mechanical, Packaging, and Orderable Information

The following pages include mechanical, packaging, and orderable information. This information is the most current data available for the designated devices. This data is subject to change without notice and revision of this document. For browser-based versions of this data sheet, refer to the left-hand navigation.

**PACKAGING INFORMATION**

| Orderable Device   | Status<br>(1) | Package Type | Package Drawing | Pins | Package Qty | Eco Plan<br>(2)         | Lead/Ball Finish<br>(6) | MSL Peak Temp<br>(3) | Op Temp (°C) | Device Marking<br>(4/5) | Samples                 |
|--------------------|---------------|--------------|-----------------|------|-------------|-------------------------|-------------------------|----------------------|--------------|-------------------------|-------------------------|
| LM3530TME-40/NOPB  | ACTIVE        | DSBGA        | YFQ             | 12   | 250         | Green (RoHS & no Sb/Br) | SNAGCU                  | Level-1-260C-UNLIM   |              | DX                      | <a href="#">Samples</a> |
| LM3530TMX-40/NOPB  | ACTIVE        | DSBGA        | YFQ             | 12   | 3000        | Green (RoHS & no Sb/Br) | SNAGCU                  | Level-1-260C-UNLIM   |              | DX                      | <a href="#">Samples</a> |
| LM3530UME-25A/NOPB | ACTIVE        | DSBGA        | YFZ             | 12   | 250         | Green (RoHS & no Sb/Br) | SNAGCU                  | Level-1-260C-UNLIM   | -30 to 85    | DS                      | <a href="#">Samples</a> |
| LM3530UME-40/NOPB  | ACTIVE        | DSBGA        | YFZ             | 12   | 250         | Green (RoHS & no Sb/Br) | SNAGCU                  | Level-1-260C-UNLIM   | -30 to 85    | 40                      | <a href="#">Samples</a> |
| LM3530UME-40B/NOPB | ACTIVE        | DSBGA        | YFZ             | 12   | 250         | Green (RoHS & no Sb/Br) | SNAGCU                  | Level-1-260C-UNLIM   |              | DT                      | <a href="#">Samples</a> |
| LM3530UMX-25A/NOPB | ACTIVE        | DSBGA        | YFZ             | 12   | 3000        | Green (RoHS & no Sb/Br) | SNAGCU                  | Level-1-260C-UNLIM   | -30 to 85    | DS                      | <a href="#">Samples</a> |
| LM3530UMX-40/NOPB  | ACTIVE        | DSBGA        | YFZ             | 12   | 3000        | Green (RoHS & no Sb/Br) | SNAGCU                  | Level-1-260C-UNLIM   | -30 to 85    | 40                      | <a href="#">Samples</a> |
| LM3530UMX-40B/NOPB | ACTIVE        | DSBGA        | YFZ             | 12   | 3000        | Green (RoHS & no Sb/Br) | SNAGCU                  | Level-1-260C-UNLIM   |              | DT                      | <a href="#">Samples</a> |

(1) The marketing status values are defined as follows:

**ACTIVE:** Product device recommended for new designs.

**LIFEBUY:** TI has announced that the device will be discontinued, and a lifetime-buy period is in effect.

**NRND:** Not recommended for new designs. Device is in production to support existing customers, but TI does not recommend using this part in a new design.

**PREVIEW:** Device has been announced but is not in production. Samples may or may not be available.

**OBSELETE:** TI has discontinued the production of the device.

(2) Eco Plan - The planned eco-friendly classification: Pb-Free (RoHS), Pb-Free (RoHS Exempt), or Green (RoHS & no Sb/Br) - please check <http://www.ti.com/productcontent> for the latest availability information and additional product content details.

**TBD:** The Pb-Free/Green conversion plan has not been defined.

**Pb-Free (RoHS):** TI's terms "Lead-Free" or "Pb-Free" mean semiconductor products that are compatible with the current RoHS requirements for all 6 substances, including the requirement that lead not exceed 0.1% by weight in homogeneous materials. Where designed to be soldered at high temperatures, TI Pb-Free products are suitable for use in specified lead-free processes.

**Pb-Free (RoHS Exempt):** This component has a RoHS exemption for either 1) lead-based flip-chip solder bumps used between the die and package, or 2) lead-based die adhesive used between the die and leadframe. The component is otherwise considered Pb-Free (RoHS compatible) as defined above.

**Green (RoHS & no Sb/Br):** TI defines "Green" to mean Pb-Free (RoHS compatible), and free of Bromine (Br) and Antimony (Sb) based flame retardants (Br or Sb do not exceed 0.1% by weight in homogeneous material)

(3) MSL, Peak Temp. - The Moisture Sensitivity Level rating according to the JEDEC industry standard classifications, and peak solder temperature.

(4) There may be additional marking, which relates to the logo, the lot trace code information, or the environmental category on the device.

(5) Multiple Device Markings will be inside parentheses. Only one Device Marking contained in parentheses and separated by a "~" will appear on a device. If a line is indented then it is a continuation of the previous line and the two combined represent the entire Device Marking for that device.

(6) Lead/Ball Finish - Orderable Devices may have multiple material finish options. Finish options are separated by a vertical ruled line. Lead/Ball Finish values may wrap to two lines if the finish value exceeds the maximum column width.

**Important Information and Disclaimer:**The information provided on this page represents TI's knowledge and belief as of the date that it is provided. TI bases its knowledge and belief on information provided by third parties, and makes no representation or warranty as to the accuracy of such information. Efforts are underway to better integrate information from third parties. TI has taken and continues to take reasonable steps to provide representative and accurate information but may not have conducted destructive testing or chemical analysis on incoming materials and chemicals. TI and TI suppliers consider certain information to be proprietary, and thus CAS numbers and other limited information may not be available for release.

In no event shall TI's liability arising out of such information exceed the total purchase price of the TI part(s) at issue in this document sold by TI to Customer on an annual basis.

**TAPE AND REEL INFORMATION**

**QUADRANT ASSIGNMENTS FOR PIN 1 ORIENTATION IN TAPE**

\*All dimensions are nominal

| Device             | Package Type | Package Drawing | Pins | SPQ  | Reel Diameter (mm) | Reel Width W1 (mm) | A0 (mm) | B0 (mm) | K0 (mm) | P1 (mm) | W (mm) | Pin1 Quadrant |
|--------------------|--------------|-----------------|------|------|--------------------|--------------------|---------|---------|---------|---------|--------|---------------|
| LM3530TME-40/NOPB  | DSBGA        | YFQ             | 12   | 250  | 178.0              | 8.4                | 1.35    | 1.75    | 0.76    | 4.0     | 8.0    | Q1            |
| LM3530TMX-40/NOPB  | DSBGA        | YFQ             | 12   | 3000 | 178.0              | 8.4                | 1.35    | 1.75    | 0.76    | 4.0     | 8.0    | Q1            |
| LM3530UME-25A/NOPB | DSBGA        | YFZ             | 12   | 250  | 178.0              | 8.4                | 1.37    | 1.77    | 0.56    | 4.0     | 8.0    | Q1            |
| LM3530UME-40/NOPB  | DSBGA        | YFZ             | 12   | 250  | 178.0              | 8.4                | 1.37    | 1.77    | 0.56    | 4.0     | 8.0    | Q1            |
| LM3530UME-40B/NOPB | DSBGA        | YFZ             | 12   | 250  | 178.0              | 8.4                | 1.37    | 1.77    | 0.56    | 4.0     | 8.0    | Q1            |
| LM3530UMX-25A/NOPB | DSBGA        | YFZ             | 12   | 3000 | 178.0              | 8.4                | 1.37    | 1.77    | 0.56    | 4.0     | 8.0    | Q1            |
| LM3530UMX-40/NOPB  | DSBGA        | YFZ             | 12   | 3000 | 178.0              | 8.4                | 1.37    | 1.77    | 0.56    | 4.0     | 8.0    | Q1            |
| LM3530UMX-40B/NOPB | DSBGA        | YFZ             | 12   | 3000 | 178.0              | 8.4                | 1.37    | 1.77    | 0.56    | 4.0     | 8.0    | Q1            |

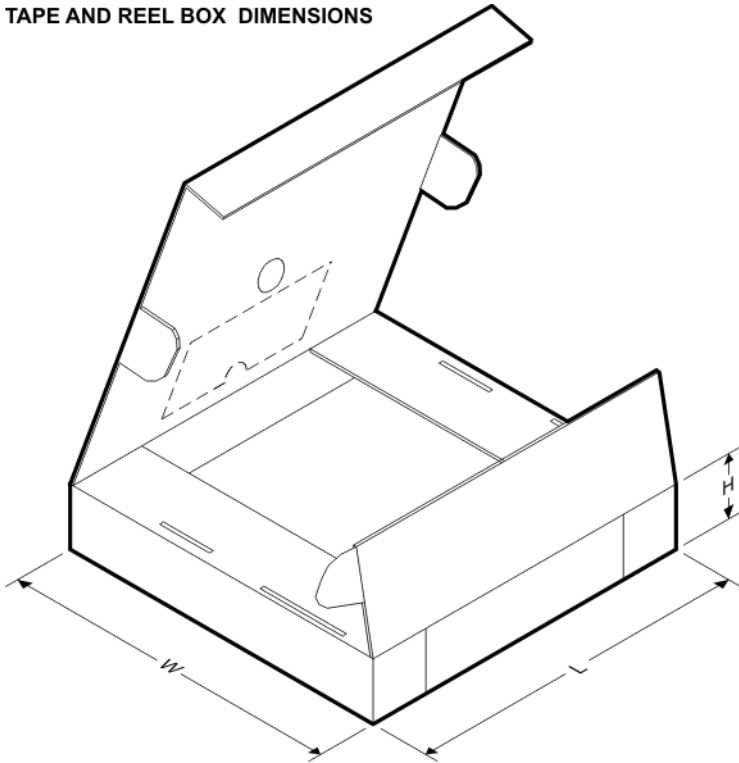
**TAPE AND REEL BOX DIMENSIONS**

\*All dimensions are nominal

| Device             | Package Type | Package Drawing | Pins | SPQ  | Length (mm) | Width (mm) | Height (mm) |
|--------------------|--------------|-----------------|------|------|-------------|------------|-------------|
| LM3530TME-40/NOPB  | DSBGA        | YFQ             | 12   | 250  | 210.0       | 185.0      | 35.0        |
| LM3530TMX-40/NOPB  | DSBGA        | YFQ             | 12   | 3000 | 210.0       | 185.0      | 35.0        |
| LM3530UME-25A/NOPB | DSBGA        | YFZ             | 12   | 250  | 210.0       | 185.0      | 35.0        |
| LM3530UME-40/NOPB  | DSBGA        | YFZ             | 12   | 250  | 210.0       | 185.0      | 35.0        |
| LM3530UME-40B/NOPB | DSBGA        | YFZ             | 12   | 250  | 210.0       | 185.0      | 35.0        |
| LM3530UMX-25A/NOPB | DSBGA        | YFZ             | 12   | 3000 | 210.0       | 185.0      | 35.0        |
| LM3530UMX-40/NOPB  | DSBGA        | YFZ             | 12   | 3000 | 210.0       | 185.0      | 35.0        |
| LM3530UMX-40B/NOPB | DSBGA        | YFZ             | 12   | 3000 | 210.0       | 185.0      | 35.0        |





## IMPORTANT NOTICE AND DISCLAIMER

TI PROVIDES TECHNICAL AND RELIABILITY DATA (INCLUDING DATASHEETS), DESIGN RESOURCES (INCLUDING REFERENCE DESIGNS), APPLICATION OR OTHER DESIGN ADVICE, WEB TOOLS, SAFETY INFORMATION, AND OTHER RESOURCES "AS IS" AND WITH ALL FAULTS, AND DISCLAIMS ALL WARRANTIES, EXPRESS AND IMPLIED, INCLUDING WITHOUT LIMITATION ANY IMPLIED WARRANTIES OF MERCHANTABILITY, FITNESS FOR A PARTICULAR PURPOSE OR NON-INFRINGEMENT OF THIRD PARTY INTELLECTUAL PROPERTY RIGHTS.

These resources are intended for skilled developers designing with TI products. You are solely responsible for (1) selecting the appropriate TI products for your application, (2) designing, validating and testing your application, and (3) ensuring your application meets applicable standards, and any other safety, security, or other requirements. These resources are subject to change without notice. TI grants you permission to use these resources only for development of an application that uses the TI products described in the resource. Other reproduction and display of these resources is prohibited. No license is granted to any other TI intellectual property right or to any third party intellectual property right. TI disclaims responsibility for, and you will fully indemnify TI and its representatives against, any claims, damages, costs, losses, and liabilities arising out of your use of these resources.

TI's products are provided subject to TI's Terms of Sale ([www.ti.com/legal/termsofsale.html](http://www.ti.com/legal/termsofsale.html)) or other applicable terms available either on [ti.com](http://ti.com) or provided in conjunction with such TI products. TI's provision of these resources does not expand or otherwise alter TI's applicable warranties or warranty disclaimers for TI products.

Mailing Address: Texas Instruments, Post Office Box 655303, Dallas, Texas 75265  
Copyright © 2019, Texas Instruments Incorporated

## Looking for pricing, stock, or lifecycle information?

Click below to explore more details on WIN SOURCE:

 [View LM3530UMX-25A on WIN SOURCE](#)

 [Texas Instruments](#) Information

## Optimize Your Supply Chain with WIN SOURCE Solutions

-  Global Sourcing Solution
-  Obsolete Management
-  Cost Control Management
-  Shortage Management
-  Alternative Solution
-  Excess Inventory Management