



# THE DATASHEET OF LM3501TL-16/NOPB



# LM3501 Synchronous Step-up DC/DC Converter for White LED Applications

Check for Samples: [LM3501](#)

## FEATURES

- Synchronous Rectification, High Efficiency and no External Schottky Diode required
- Uses Small Surface Mount Components
- Can Drive 2-5 White LEDs in Series (May Function with More Low  $V_F$  LEDs)
- 2.7V to 7V Input Range
- True Shutdown Isolation, no LED Leakage Current
- DC Voltage LED Current Control
- Input Undervoltage Lockout
- Internal Output Over-Voltage Protection (OVP) Circuitry, with no External Zener Diode Required LM3501-16: 15.5V OVP; LM3501-21: 20.5V OVP.
- Requires Only a Small 16V (LM3501-16) or 25V (LM3501-21) Ceramic Capacitor at the Input and Output
- Thermal Shutdown
- 0.1 $\mu$ A shutdown Current
- Small 8-Bump Thin DSBGA Package

## APPLICATIONS

- LCD Bias Supplies
- White LED Back-Lighting
- Handheld Devices
- Digital Cameras
- Portable Applications

## DESCRIPTION

The LM3501 is a fixed-frequency step-up DC/DC converter that is ideal for driving white LEDs for display backlighting and other lighting functions. With fully integrated synchronous switching (no external schottky diode required) and a low feedback voltage (515 mV), power efficiency of the LM3501 circuit has been optimized for lighting applications in wireless phones and other portable products (single cell Li-Ion or 3-cell NiMH battery supplies). The LM3501 operates with a fixed 1 MHz switching frequency. When used with ceramic input and output capacitors, the LM3501 provides a small, low-noise, low-cost solution.

## Typical Application Circuit

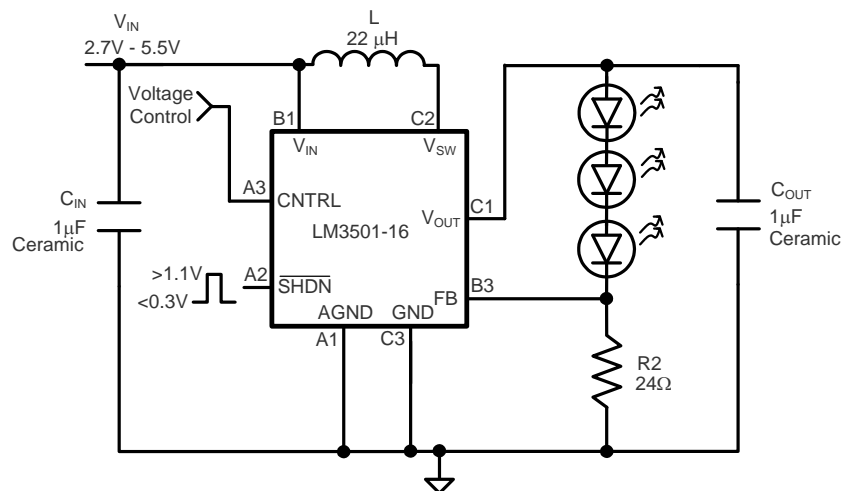

Figure 1. Typical 3 LED Application



Please be aware that an important notice concerning availability, standard warranty, and use in critical applications of Texas Instruments semiconductor products and disclaimers thereto appears at the end of this data sheet.

All trademarks are the property of their respective owners.

## DESCRIPTION (CONTINUED)

Two LM3501 options are available with different output voltage capabilities. The LM3501-21 has a maximum output voltage of 21V and is typically suited for driving 4 or 5 white LEDs in series. The LM3501-16 has a maximum output voltage of 16V and is typically suited for driving 3 or 4 white LEDs in series (maximum number of series LEDs dependent on LED forward voltage). If the primary white LED network should be disconnected, the LM3501 uses internal protection circuitry on the output to prevent a destructive overvoltage event.

A single external resistor is used to set the maximum LED current in LED-drive applications. The LED current can easily be adjusted by varying the analog control voltage on the control pin or by using a pulse width modulated (PWM) signal on the shutdown pin. In shutdown, the LM3501 completely disconnects the input from output, creating total isolation and preventing any leakage currents from trickling into the LEDs.

## Connection Diagram

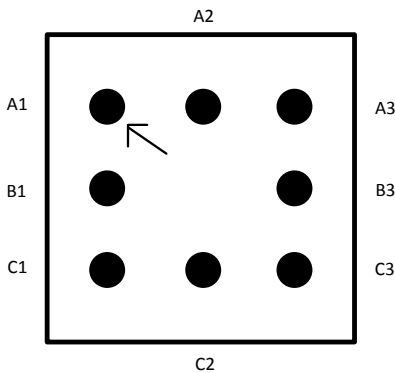

**Figure 2. 8-Bump DSBGA  
Top View**

**PIN DESCRIPTIONS**

Pin	Name	Function
A1	AGND	Analog ground.
B1	V <sub>IN</sub>	Analog and Power supply input.
C1	V <sub>OUT</sub>	PMOS source connection for synchronous rectification.
C2	V <sub>SW</sub>	Switch pin. Drain connections of both NMOS and PMOS power devices.
C3	GND	Power Ground.
B3	FB	Output voltage feedback connection.
A3	CNTRL	Analog LED current control.
A2	$\overline{\text{SHDN}}$	Shutdown control pin.

**AGND (pin A1):** Analog ground pin

The analog ground pin should tie directly to the GND pin.

**V<sub>IN</sub> (pin B1):** Analog and Power supply pin

Bypass this pin with a capacitor, as close to the device as possible, connected between the V<sub>IN</sub> and GND pins.

**V<sub>OUT</sub> (pin C1):** Source connection of internal PMOS power device

Connect the output capacitor between the V<sub>OUT</sub> and GND pins as close as possible to the device.

**V<sub>SW</sub> (pin C2):** Drain connection of internal NMOS and PMOS switch devices

Keep the inductor connection close to this pin to minimize EMI radiation.

**GND (pin C3):** Power ground pin

Tie directly to ground plane.

**FB (pin B3):** Output voltage feedback connection

Set the primary White LED network current with a resistor from the FB pin to GND. Keep the current setting resistor close to the device and connected between the FB and GND pins.

**CNTRL (pin A3):** Analog control of LED current

A voltage above 125 mV will begin to regulate the LED current. Decreasing the voltage below 75 mV will turn off the LEDs.

 **$\overline{\text{SHDN}}$  (pin A2):** Shutdown control pin

Disable the device with a voltage less than 0.3V and enable the device with a voltage greater than 1.1V. The white LED current can be controlled using a PWM signal at this pin. There is an internal pull down on the  $\overline{\text{SHDN}}$  pin, the device is in a normally off state.



These devices have limited built-in ESD protection. The leads should be shorted together or the device placed in conductive foam during storage or handling to prevent electrostatic damage to the MOS gates.

### Absolute Maximum Ratings <sup>(1)(2)</sup>

$V_{IN}$	-0.3V to 7.5V
$V_{OUT}$ (LM3501-16) <sup>(3)</sup>	-0.3V to 16V
$V_{OUT}$ (LM3501-21) <sup>(3)</sup>	-0.3V to 21V
$V_{SW}$ <sup>(3)</sup>	-0.3V to $V_{OUT}+0.3V$
FB Voltage	-0.3V to 7.5V
$\overline{SHDN}$ Voltage	-0.3V to $V_{IN}+0.3V$
CNTRL	-0.3V to 7.5V
Maximum Junction Temperature	150°C
Lead Temperature (Soldering 10 sec.)	300°C
Vapor Phase (60 sec.)	215°C
Infrared (15 sec.)	220°C
ESD Ratings <sup>(4)</sup>	
Human Body Model	2kV
Machine Model	200V

- (1) Absolute maximum ratings are limits beyond which damage to the device may occur. Operating Ratings are conditions for which the device is intended to be functional, but device parameter specifications may not be specified. For specifications and test conditions, see the Electrical Characteristics.
- (2) Military/Aerospace specified devices are required, please contact the Texas Instruments Sales Office/ Distributors for availability and specifications.
- (3) This condition applies if  $V_{IN} < V_{OUT}$ . If  $V_{IN} > V_{OUT}$ , a voltage greater than  $V_{IN} + 0.3V$  should not be applied to the  $V_{OUT}$  or  $V_{SW}$  pins.
- (4) The human body model is a 100 pF capacitor discharged through a 1.5 k $\Omega$  resistor into each pin. The machine model is a 200 pF capacitor discharged directly into each pin.

### Operating Conditions

Junction Temperature <sup>(1)</sup>	-40°C to +125°C
Supply Voltage	2.7V to 7V
CNTRL Max.	2.7V

- (1) The maximum allowable power dissipation is a function of the maximum operating junction temperature,  $T_{J(MAX)}$ , the junction-to-ambient thermal resistance,  $\theta_{JA}$ , and the ambient temperature,  $T_A$ . See the *Thermal Properties* section for the thermal resistance. The maximum allowable power dissipation at any ambient temperature is calculated using:  $P_D (MAX) = (T_{J(MAX)} - T_A)/\theta_{JA}$ . Exceeding the maximum allowable power dissipation will cause excessive die temperature.

### Thermal Properties

Junction to Ambient Thermal Resistance ( $\theta_{JA}$ ) <sup>(1)</sup>	75°C/W
-------------------------------------------------------------------------	--------

- (1) Junction-to-ambient thermal resistance ( $\theta_{JA}$ ) is highly application and board-layout dependent. The 75°C/W figure provided was measured on a 4-layer test board conforming to JEDEC standards. In applications where high maximum power dissipation exists, special care must be paid to thermal dissipation issues when designing the board layout.

## Electrical Characteristics

Specifications in standard type face are for  $T_A = 25^\circ\text{C}$  and those in **boldface type** apply over the **Operating Temperature Range of  $T_A = -10^\circ\text{C}$  to  $+85^\circ\text{C}$** . Unless otherwise specified  $V_{IN} = 2.7\text{V}$  and specifications apply to both LM3501-16 and LM3501-21.

Symbol	Parameter	Conditions	Min (1)	Typ (2)	Max (1)	Units
$I_Q$	Quiescent Current, Device Not Switching	$FB > 0.54\text{V}$		0.95	<b>1.2</b>	mA
	Quiescent Current, Device Switching	$FB = 0\text{V}$		2	<b>2.5</b>	
	Shutdown	$\overline{\text{SHDN}} = 0\text{V}$		0.1	<b>2</b>	$\mu\text{A}$
$V_{FB}$	Feedback Voltage	$\text{CNTRL} = 2.7\text{V}$ , $V_{IN} = 2.7\text{V}$ to $7\text{V}$	<b>0.485</b>	0.515	<b>0.545</b>	V
		$\text{CNTRL} = 1\text{V}$ , $V_{IN} = 2.7\text{V}$ to $7\text{V}$	<b>0.14</b>	0.19	<b>0.24</b>	
$\Delta V_{FB}$	Feedback Voltage Line Regulation	$V_{IN} = 2.7\text{V}$ to $7\text{V}$		0.1	<b>0.5</b>	$\%/V$
$I_{CL}$	Switch Current Limit (LM3501-16)	$V_{IN} = 2.7\text{V}$ , Duty Cycle = 80%	<b>275</b>	400	<b>480</b>	mA
		$V_{IN} = 3.0\text{V}$ , Duty Cycle = 70%	<b>255</b>	400	<b>530</b>	
	Switch Current Limit (LM3501-21)	$V_{IN} = 2.7\text{V}$ , Duty Cycle = 70%	<b>420</b>	640	<b>770</b>	
		$V_{IN} = 3.0\text{V}$ , Duty Cycle = 63%	<b>450</b>	670	<b>800</b>	
$I_B$	FB Pin Bias Current	$FB = 0.5\text{V}$ (3)		45	<b>200</b>	nA
$V_{IN}$	Input Voltage Range		<b>2.7</b>		<b>7.0</b>	V
$R_{DS(on)}$	NMOS Switch $R_{DS(on)}$	$V_{IN} = 2.7\text{V}$ , $I_{SW} = 300\text{mA}$			0.43	$\Omega$
	PMOS Switch $R_{DS(on)}$	$V_{OUT} = 6\text{V}$ , $I_{SW} = 300\text{mA}$		1.3	<b>2.3</b>	
$D_{Limit}$	Duty Cycle Limit (LM3501-16)	$FB = 0\text{V}$	<b>80</b>	87		%
	Duty Cycle Limit (LM3501-21)	$FB = 0\text{V}$	<b>85</b>	94		
$F_{SW}$	Switching Frequency		<b>0.85</b>	1.0	<b>1.15</b>	MHz
$I_{SD}$	$\overline{\text{SHDN}}$ Pin Current (4)	$\overline{\text{SHDN}} = 5.5\text{V}$		1.8	<b>4</b>	$\mu\text{A}$
		$\overline{\text{SHDN}} = 2.7\text{V}$		1	<b>2.5</b>	
		$\overline{\text{SHDN}} = \text{GND}$		0.1		
$I_{CNTRL}$	CNTRL Pin Current (4)	$V_{CNTRL} = 2.7\text{V}$		10	<b>20</b>	$\mu\text{A}$
		$V_{CNTRL} = 1\text{V}$		4	<b>15</b>	
$I_L$	Switch Leakage Current (LM3501-16)	$V_{SW} = 15\text{V}$		0.01	<b>0.5</b>	$\mu\text{A}$
	Switch Leakage Current (LM3501-21)	$V_{SW} = 20\text{V}$		0.01	<b>2.0</b>	
UVP	Input Undervoltage Lockout	ON Threshold	<b>2.4</b>	2.5	<b>2.6</b>	V
		OFF Threshold	<b>2.3</b>	2.4	<b>2.5</b>	
OVP	Output Overvoltage Protection (LM3501-16)	ON Threshold	<b>15</b>	15.5	<b>16</b>	V
		OFF Threshold	<b>14</b>	14.6	<b>15</b>	
	Output Overvoltage Protection (LM3501-21)	ON Threshold	<b>20</b>	20.5	<b>21</b>	V
		OFF Threshold	<b>19</b>	19.5	<b>20</b>	

(1) All limits specified at room temperature (standard typeface) and at temperature extremes (bold typeface). All room temperature limits are production tested, specified through statistical analysis or specified by design. All limits at temperature extremes are specified via correlation using standard Statistical Quality Control (SQC) methods. All limits are used to calculate Average Outgoing Quality Level (AOQL).

(2) Typical numbers are at  $25^\circ\text{C}$  and represent the most likely norm.

(3) Feedback current flows out of the pin.

(4) Current flows into the pin.

## Electrical Characteristics (continued)

Specifications in standard type face are for  $T_A = 25^\circ\text{C}$  and those in **boldface type** apply over the **Operating Temperature Range of  $T_A = -10^\circ\text{C}$  to  $+85^\circ\text{C}$** . Unless otherwise specified  $V_{IN} = 2.7\text{V}$  and specifications apply to both LM3501-16 and LM3501-21.

Symbol	Parameter	Conditions	Min (1)	Typ (2)	Max (1)	Units
$I_{Vout}$	$V_{OUT}$ Bias Current (LM3501-16)	$V_{OUT} = 15\text{V}$ , $\overline{\text{SHDN}} = 1.5\text{V}$		260	<b>400</b>	$\mu\text{A}$
	$V_{OUT}$ Bias Current (LM3501-21)	$V_{OUT} = 20\text{V}$ , $\overline{\text{SHDN}} = 1.5\text{V}$		300	<b>460</b>	
$I_{VL}$	PMOS Switch Leakage Current (LM3501-16)	$V_{OUT} = 15\text{V}$ , $V_{SW} = 0\text{V}$		0.01	<b>3</b>	$\mu\text{A}$
	PMOS Switch Leakage Current (LM3501-21)	$V_{OUT} = 20\text{V}$ , $V_{SW} = 0\text{V}$		0.01	<b>3</b>	
CNTRL Threshold		LED power off		75		mV
		LED power on		125		
$\overline{\text{SHDN}}$ Threshold	$\overline{\text{SHDN}}$ low			0.65	<b>0.3</b>	V
	$\overline{\text{SHDN}}$ High		<b>1.1</b>	0.65		

Specifications in standard type face are for  $T_J = 25^\circ\text{C}$  and those in **boldface type** apply over the full **Operating Temperature Range ( $T_J = -40^\circ\text{C}$  to  $+125^\circ\text{C}$ )**. Unless otherwise specified  $V_{IN} = 2.7\text{V}$  and specifications apply to both LM3501-16 and LM3501-21.

Symbol	Parameter	Conditions	Min (1)	Typ (2)	Max (1)	Units
$I_Q$	Quiescent Current, Device Not Switching	$\text{FB} > 0.54\text{V}$		0.95	<b>1.2</b>	mA
	Quiescent Current, Device Switching	$\text{FB} = 0\text{V}$		2	<b>2.5</b>	
	Shutdown	$\overline{\text{SHDN}} = 0\text{V}$		0.1	<b>2</b>	$\mu\text{A}$
$V_{FB}$	Feedback Voltage	$\text{CNTRL} = 2.7\text{V}$ , $V_{IN} = 2.7\text{V}$ to $7\text{V}$	<b>0.485</b>	0.515	<b>0.545</b>	V
		$\text{CNTRL} = 1\text{V}$ , $V_{IN} = 2.7\text{V}$ to $7\text{V}$	<b>0.14</b>	0.19	<b>0.24</b>	
$\Delta V_{FB}$	Feedback Voltage Line Regulation	$V_{IN} = 2.7\text{V}$ to $7\text{V}$		0.1	<b>0.5</b>	%/V
$I_{CL}$	Switch Current Limit (LM3501-16)	$V_{IN} = 3.0\text{V}$ , Duty Cycle = 70%		400		mA
	Switch Current Limit (LM3501-21)	$V_{IN} = 3.0\text{V}$ , Duty Cycle = 63%		670		
$I_B$	FB Pin Bias Current	$\text{FB} = 0.5\text{V}$ (3)		45	<b>200</b>	nA
$V_{IN}$	Input Voltage Range		<b>2.7</b>		<b>7.0</b>	V
$R_{DS(on)}$	NMOS Switch $R_{DS(on)}$	$V_{IN} = 2.7\text{V}$ , $I_{SW} = 300\text{mA}$			0.43	$\Omega$
	PMOS Switch $R_{DS(on)}$	$V_{OUT} = 6\text{V}$ , $I_{SW} = 300\text{mA}$		1.3	<b>2.3</b>	
$D_{Limit}$	Duty Cycle Limit (LM3501-16)	$\text{FB} = 0\text{V}$		87		%
	Duty Cycle Limit (LM3501-21)	$\text{FB} = 0\text{V}$		94		
$F_{SW}$	Switching Frequency		<b>0.8</b>	1.0	<b>1.2</b>	MHz
$I_{SD}$	$\overline{\text{SHDN}}$ Pin Current (4)	$\overline{\text{SHDN}} = 5.5\text{V}$		1.8	<b>4</b>	$\mu\text{A}$
		$\overline{\text{SHDN}} = 2.7\text{V}$		1	<b>2.5</b>	
		$\overline{\text{SHDN}} = \text{GND}$		0.1		

- (1) All limits specified at room temperature (standard typeface) and at temperature extremes (bold typeface). All room temperature limits are production tested, specified through statistical analysis or specified by design. All limits at temperature extremes are specified via correlation using standard Statistical Quality Control (SQC) methods. All limits are used to calculate Average Outgoing Quality Level (AOQL).
- (2) Typical numbers are at  $25^\circ\text{C}$  and represent the most likely norm.
- (3) Feedback current flows out of the pin.
- (4) Current flows into the pin.

Specifications in standard type face are for  $T_J = 25^\circ\text{C}$  and those in **boldface type** apply over the full **Operating Temperature Range ( $T_J = -40^\circ\text{C}$  to  $+125^\circ\text{C}$ )**. Unless otherwise specified  $V_{IN} = 2.7\text{V}$  and specifications apply to both LM3501-16 and LM3501-21.

Symbol	Parameter	Conditions	Min (1)	Typ (2)	Max (1)	Units
$I_{\text{CNTRL}}$	CNTRL Pin Current <sup>(4)</sup>	$V_{\text{CNTRL}} = 2.7\text{V}$		10	<b>20</b>	$\mu\text{A}$
		$V_{\text{CNTRL}} = 1\text{V}$		4	<b>15</b>	
$I_{\text{L}}$	Switch Leakage Current (LM3501-16)	$V_{\text{SW}} = 15\text{V}$		0.01	<b>0.5</b>	$\mu\text{A}$
	Switch Leakage Current (LM3501-21)	$V_{\text{SW}} = 20\text{V}$		0.01	<b>2.0</b>	
UVP	Input Undervoltage Lockout	ON Threshold	<b>2.4</b>	2.5	<b>2.6</b>	V
		OFF Threshold	<b>2.3</b>	2.4	<b>2.5</b>	
OVP	Output Overvoltage Protection (LM3501-16)	ON Threshold	<b>15</b>	15.5	<b>16</b>	V
		OFF Threshold	<b>14</b>	14.6	<b>15</b>	
	Output Overvoltage Protection (LM3501-21)	ON Threshold	<b>20</b>	20.5	<b>21</b>	
		OFF Threshold	<b>19</b>	19.5	<b>20</b>	
$I_{\text{Vout}}$	$V_{\text{OUT}}$ Leakage Current (LM3501-16)	$V_{\text{OUT}} = 15\text{V}, \overline{\text{SHDN}} = 1.5\text{V}$		260	<b>400</b>	$\mu\text{A}$
	$V_{\text{OUT}}$ Leakage Current (LM3501-21)	$V_{\text{OUT}} = 20\text{V}, \overline{\text{SHDN}} = 1.5\text{V}$		300	<b>460</b>	
$I_{\text{VL}}$	PMOS Switch Leakage Current (LM3501-16)	$V_{\text{OUT}} = 15\text{V}, V_{\text{SW}} = 0\text{V}$		0.01	<b>3</b>	$\mu\text{A}$
	PMOS Switch Leakage Current (LM3501-21)	$V_{\text{OUT}} = 20\text{V}, V_{\text{SW}} = 0\text{V}$		0.01	<b>3</b>	
CNTRL Threshold		LED power off		75		mV
		LED power on		125		
$\overline{\text{SHDN}}$ Threshold	$\overline{\text{SHDN}}$ low			0.65	<b>0.3</b>	V
	$\overline{\text{SHDN}}$ High		<b>1.1</b>	0.65		

Typical Performance Characteristics

Switching Quiescent Current vs.  $V_{IN}$

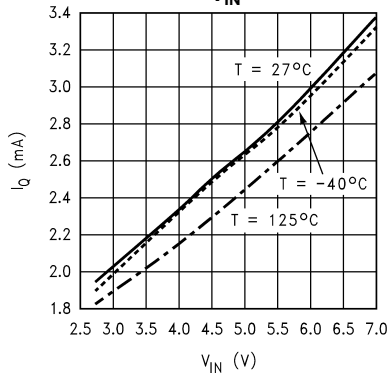

Figure 3.

Non-Switching Quiescent Current vs.  $V_{IN}$

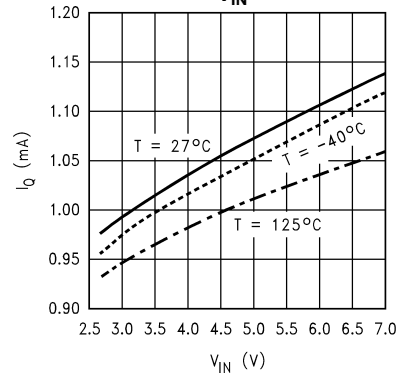

Figure 4.

2 LED Efficiency vs. Load Current  
L = Coilcraft DT1608C-223,  
Efficiency =  $100 \cdot (P_{IN} / (2V_{LED} \cdot I_{LED}))$

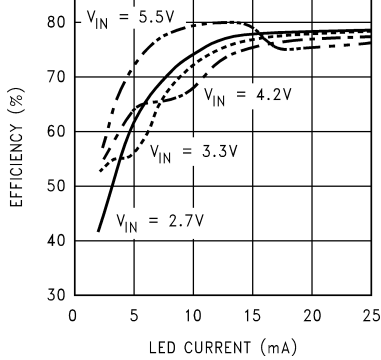

Figure 5.

3 LED Efficiency vs. Load Current  
L = Coilcraft DT1608C-223,  
Efficiency =  $100 \cdot (P_{IN} / (3V_{LED} \cdot I_{LED}))$

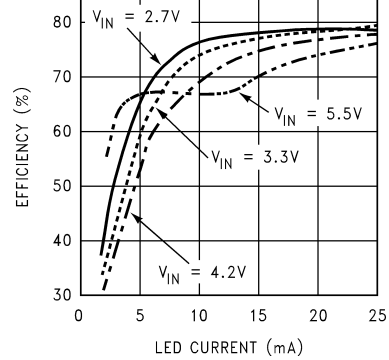

Figure 6.

4 LED Efficiency vs. Load Current  
L = Coilcraft DT1608C-223,  
Efficiency =  $100 \cdot (P_{IN} / (4V_{LED} \cdot I_{LED}))$

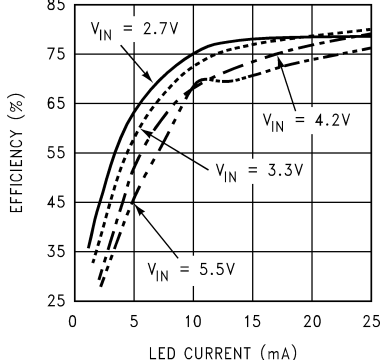

Figure 7.

Output Power vs.  $V_{IN}$   
(LM3501-16, L = Coilcraft DT1608C-223)

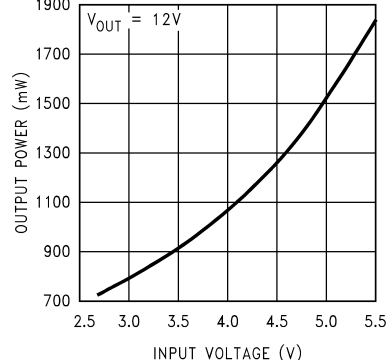

Figure 8.

Typical Performance Characteristics (continued)

Output Power vs. Temperature (LM3501-16, L = Coilcraft DT1608C-223)

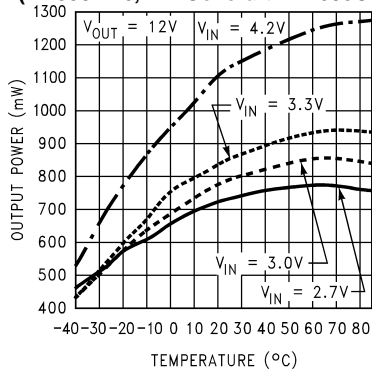

Figure 9.

FB Pin Current vs. Temperature

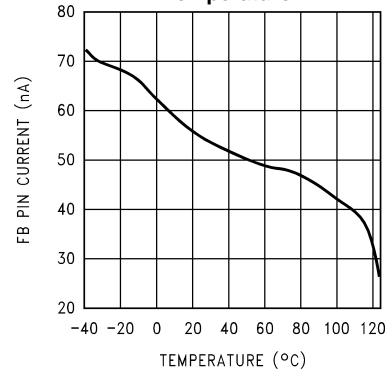

Figure 10.

SHDN Pin Current vs. SHDN Pin Voltage

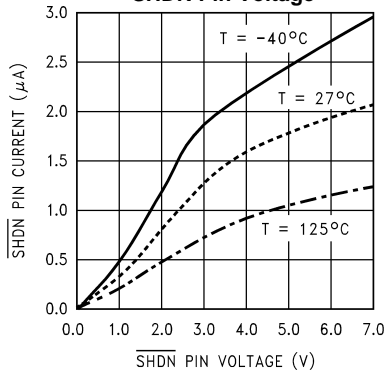

Figure 11.

CNTRL Pin Current vs. CNTRL Pin Voltage

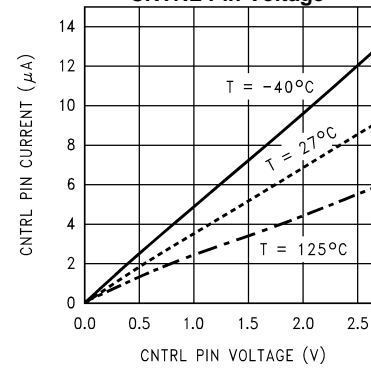

Figure 12.

FB Voltage vs. CNTRL Voltage

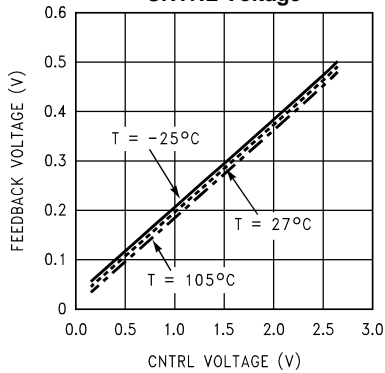

Figure 13.

Switch Current Limit vs. V\_IN (LM3501-16)

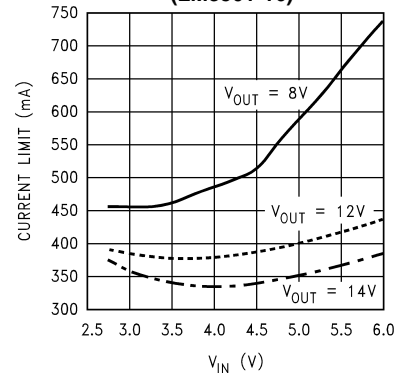

Figure 14.

**Typical Performance Characteristics (continued)**

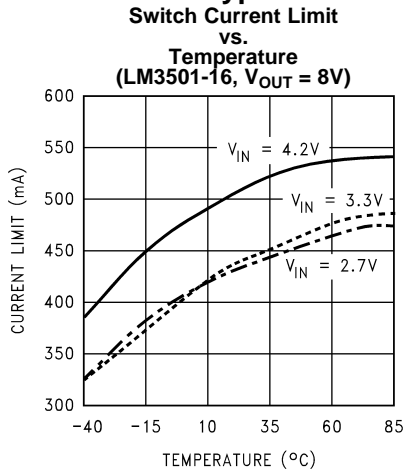

Figure 15.

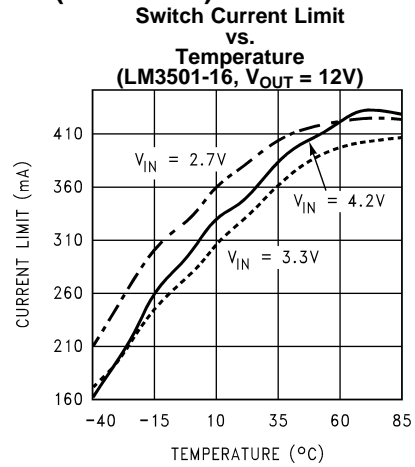

Figure 16.

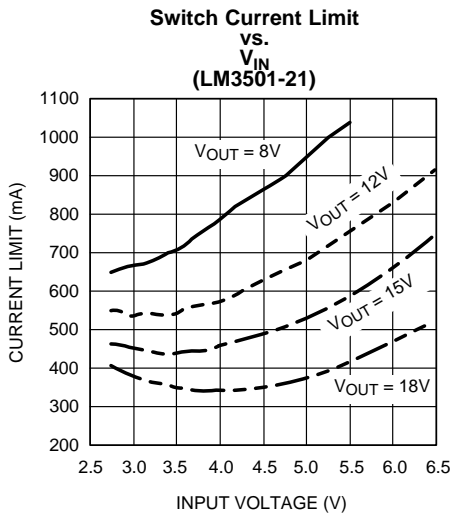

Figure 17.

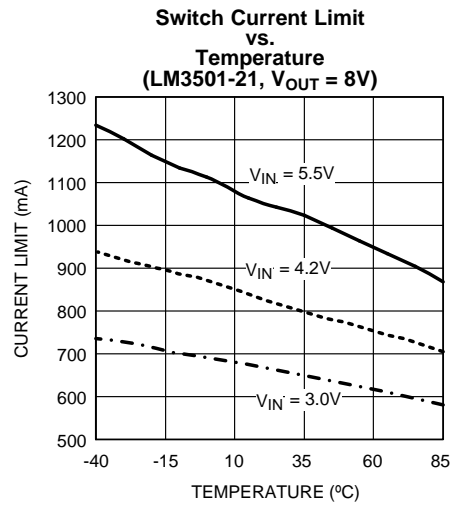

Figure 18.

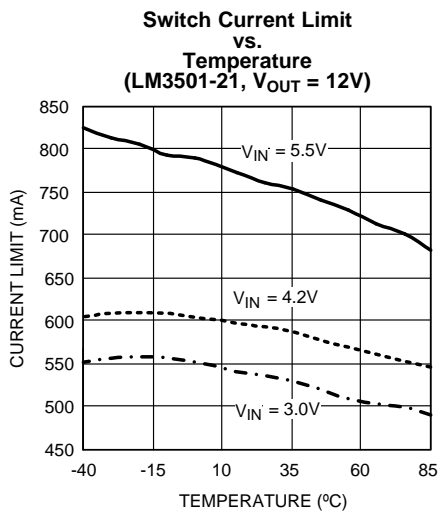

Figure 19.

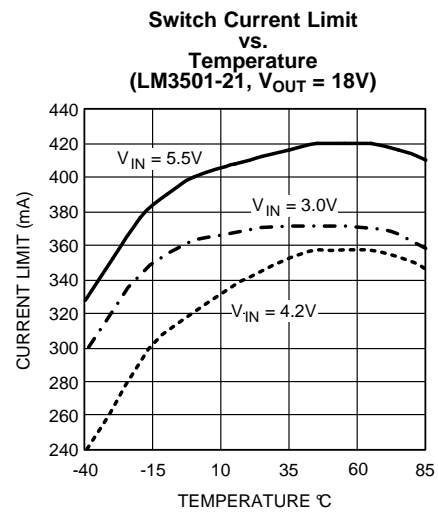

Figure 20.

Typical Performance Characteristics (continued)

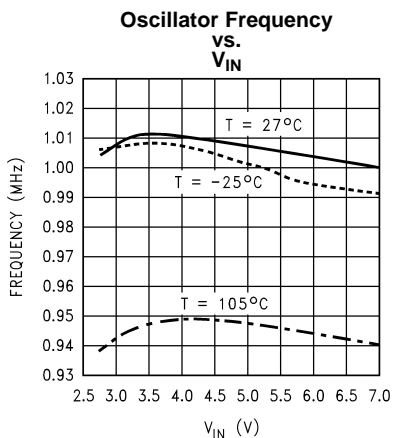

Figure 21.

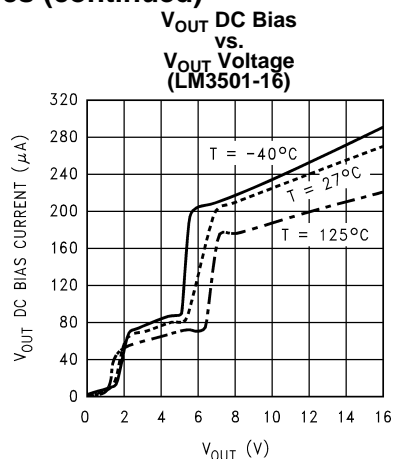

Figure 22.

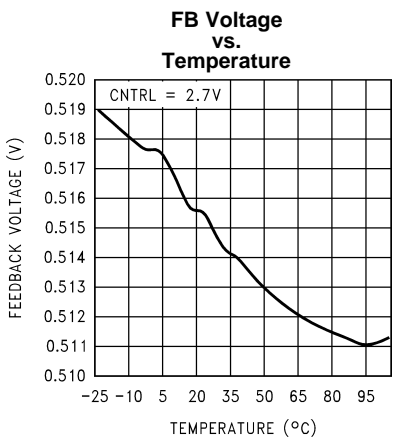

Figure 23.

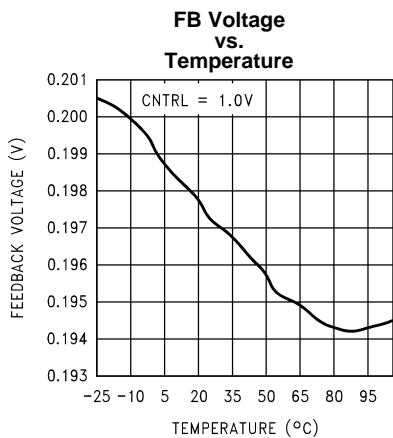

Figure 24.

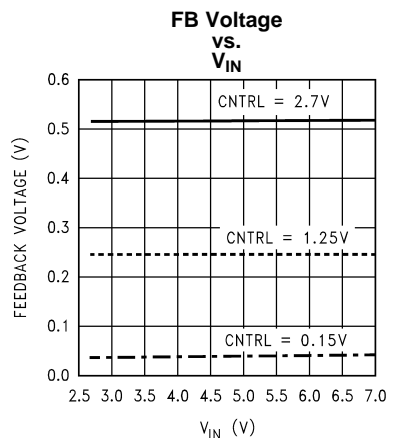

Figure 25.

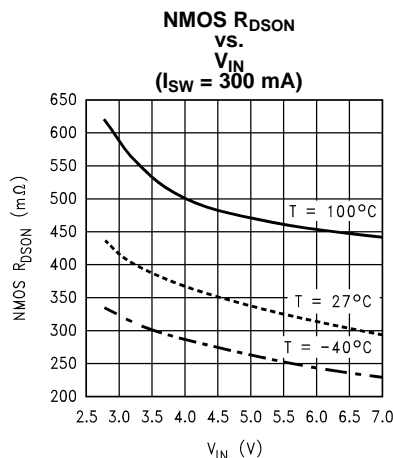

Figure 26.

Typical Performance Characteristics (continued)

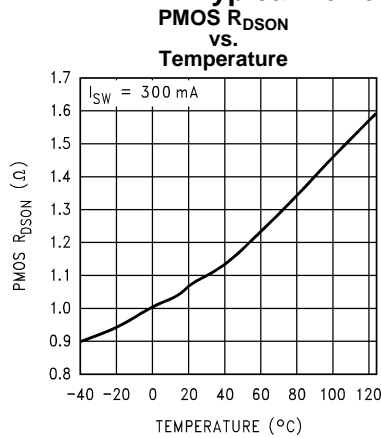
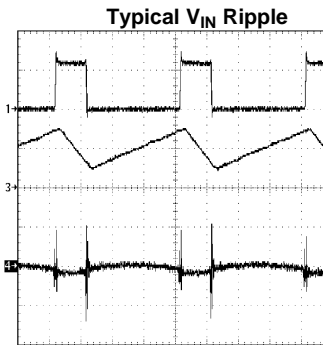
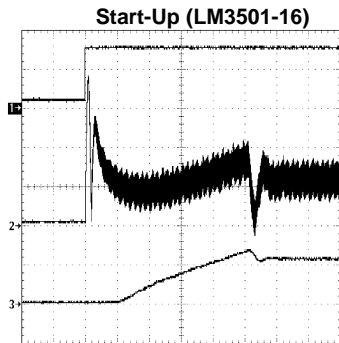

Figure 27.



3 LEDs,  $R_{LED} = 22\Omega$ ,  $V_{IN} = 3.0V$ ,  $CNTRL = 2.7V$   
 1) SW, 10 V/div, DC  
 3)  $I_L$ , 100 mA/div, DC  
 4)  $V_{IN}$ , 100 mV/div, AC  
 T = 250 ns/div

Figure 28.



3 LEDs,  $R_{LED} = 22\Omega$ ,  $V_{IN} = 3.0V$ ,  $CNTRL = 2.7V$   
 1)  $\overline{SHDN}$ , 1 V/div, DC  
 2)  $I_L$ , 100 mA/div, DC  
 3)  $I_{LED}$ , 20 mA/div, DC  
 T = 100  $\mu$ s/div

Figure 29.

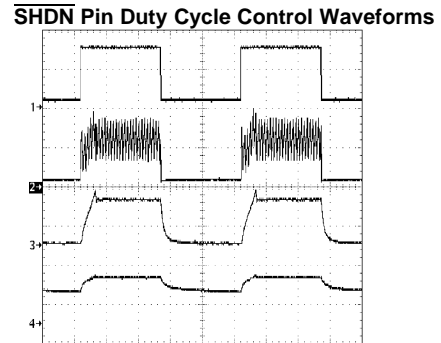

LM3501-16, 3 LEDs,  $R_{LED} = 22\Omega$ ,  $V_{IN} = 3.0V$ ,  $\overline{SHDN}$  frequency = 200 Hz  
 1)  $\overline{SHDN}$ , 1 V/div, DC  
 2)  $I_L$ , 100 mA/div, DC  
 3)  $I_{LED}$ , 20 mA/div, DC  
 4)  $V_{OUT}$ , 10 V/div, DC  
 T = 1 ms/div

Figure 30.

Typical  $V_{OUT}$  Ripple, OVP Functioning (LM3501-16)

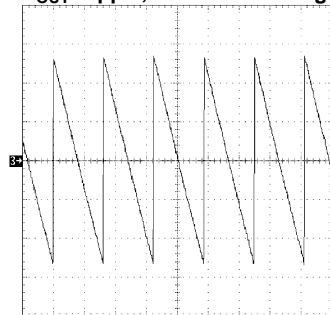

$V_{OUT}$  open circuit and equals approximately 15V DC,  $V_{IN} = 3.0V$   
 3)  $V_{OUT}$ , 200 mV/div, AC  
 T = 1 ms/div

Figure 31.

Typical  $V_{OUT}$  Ripple, OVP Functioning (LM3501-21)

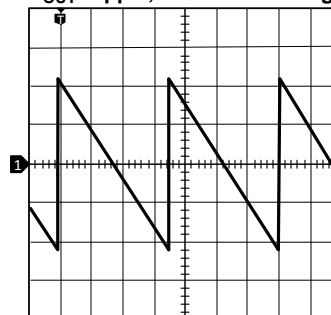

$V_{OUT}$  open circuit and equals approximately 20V DC,  $V_{IN} = 3.0V$   
 1)  $V_{OUT}$ , 200 mV/div, AC  
 T = 400  $\mu$ s/div

Figure 32.

Operation

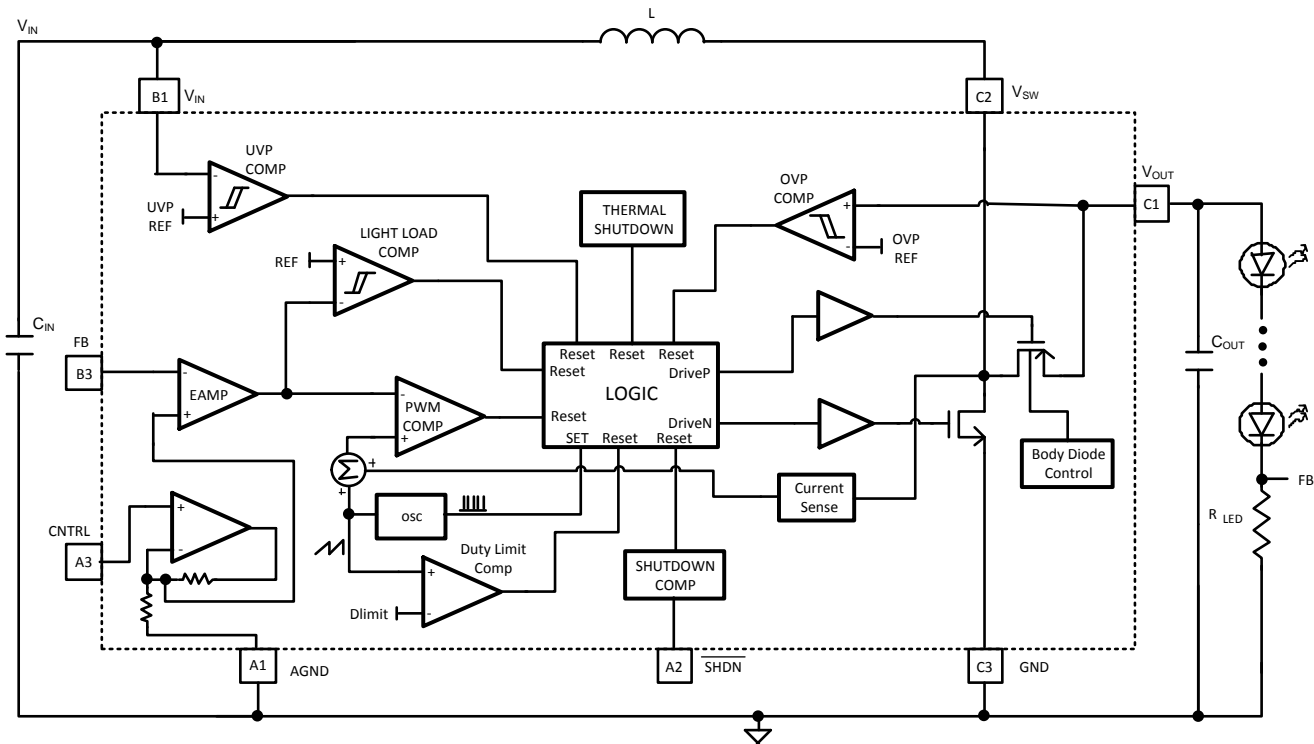

Figure 33. LM3501 Block Diagram

The LM3501 utilizes a synchronous Current Mode PWM control scheme to regulate the feedback voltage over almost all load conditions. The DC/DC controller acts as a controlled current source ideal for white LED applications. The LM3501 is internally compensated thus eliminating the requirement for any external compensation components providing a compact overall solution. The operation can best be understood referring to the block diagram in Figure 33. At the start of each cycle, the oscillator sets the driver logic and turns on the NMOS power device conducting current through the inductor and turns off the PMOS power device isolating the output from the  $V_{SW}$  pin. The LED current is supplied by the output capacitor when the NMOS power device is active. During this cycle, the output voltage of the EAMP controls the current through the inductor. This voltage will increase for larger loads and decrease for smaller loads limiting the peak current in the inductor minimizing EMI radiation. The EAMP voltage is compared with a voltage ramp and the sensed switch voltage. Once this voltage reaches the EAMP output voltage, the PWM COMP will then reset the logic turning off the NMOS power device and turning on the PMOS power device. The inductor current then flows through the PMOS power device to the white LED load and output capacitor. The inductor current recharges the output capacitor and supplies the current for the white LED branches. The oscillator then sets the driver logic again repeating the process. The Duty Limit Comp is always operational preventing the NMOS power switch from being on more than one cycle and conducting large amounts of current.

The LM3501 has dedicated protection circuitry active during normal operation to protect the IC and the external components. The Thermal Shutdown circuitry turns off both the NMOS and PMOS power devices when the die temperature reaches excessive levels. The LM3501 has a UVP Comp that disables both the NMOS and PMOS power devices when battery voltages are too low preventing an on state of the power devices which could conduct large amounts of current. The OVP Comp prevents the output voltage from increasing beyond 15.5V (LM3501-16) and 20.5V (LM3501-21) when the primary white LED network is removed or if there is an LED failure, allowing the use of small (16V for LM3501-16 and 25V for LM3501-21) ceramic capacitors at the output. This comparator has hysteresis that will regulate the output voltage between 15.5V and 14.6V typically for the LM3501-16, and between 20.5V and 19.5V for the LM3501-21. The LM3501 features a shutdown mode that reduces the supply current to 0.1  $\mu$ A and isolates the input and output of the converter. The CNTRL pin can be used to change the white LED current. A CNTRL voltage above 125 mV will enable power to the LEDs and a voltage lower than 75 mV will turn off the power to the LEDs.

## APPLICATION INFORMATION

### ADJUSTING LED CURRENT

The maximum White LED current is set using the following equation:

$$I_{LED} = V_{FB(MAX)}/R_{LED} \quad (1)$$

The LED current can be controlled using an external DC voltage. The recommended operating range for the voltage on the CNTRL pin is 0V to 2.7V. When CNTRL is 2.7V, FB = 0.515V (typ.) The FB voltage will continue to increase if CNTRL is brought above 2.7V (not recommended). The CNTRL to FB voltage relationship is:

$$FB = 0.191 * CNTRL \quad (2)$$

The LED current can be controlled using a PWM signal on the  $\overline{SHDN}$  pin with frequencies in the range of 100 Hz (greater than visible frequency spectrum) to 1 kHz. For controlling LED currents down to the  $\mu$ A levels, it is best to use a PWM signal frequency between 200-500 Hz. The LM3501 LED current can be controlled with PWM signal frequencies above 1 kHz but the controllable current decreases with higher frequency. The maximum LED current would be achieved using the equation above with 100% duty cycle, ie. the  $\overline{SHDN}$  pin always high.

Applying a voltage greater than 125 mV to the CNTRL pin will begin regulating current to the LEDs. A voltage below 75 mV will prevent application or regulation of the LED current.

### LED-DRIVE CAPABILITY

The maximum number of LEDs that can be driven by the LM3501 is limited by the output voltage capability of the LM3501. When using the LM3501 in the typical application configuration, with LEDs stacked in series between the  $V_{OUT}$  and FB pins, the maximum number of LEDs that can be placed in series ( $N_{MAX}$ ) is dependent on the maximum LED forward voltage ( $V_{F-MAX}$ ), the voltage of the LM3501 feedback pin ( $V_{FB-MAX} = 0.545V$ ), and the minimum output overvoltage protection level of the chosen LM3501 option (LM3501-16:  $OVP_{MIN} = 15V$ ; LM3501-21:  $OVP_{MIN} = 20V$ ). For the circuit to function properly, the following inequality must be met:

$$(N_{MAX} \times V_{F-MAX}) + 0.545V \leq OVP_{MIN} \quad (3)$$

When inserting a value for maximum LED VF, LED forward voltage variation over the operating temperature range should be considered. The table below provides maximum LED voltage numbers for the LM3501-16 and LM3501-21 in the typical application circuit configuration (with 3, 4, 5, 6, or 7 LEDs placed in series between the  $V_{OUT}$  and FB pins).

# of LEDs (in series)	Maximum LED $V_F$	
	LM3501-16	LM3501-21
3	4.82V	6.49V
4	3.61V	4.86V
5	2.89V	3.89V
6	X	3.24V
7	X	2.78V

For the LM3501 to operate properly, the output voltage must be kept above the input voltage during operation. For most applications, this requires a minimum of 2 LEDs (total of 6V or more) between the FB and  $V_{OUT}$  pins.

### OUTPUT OVERVOLTAGE PROTECTION

The LM3501 contains dedicated circuitry for monitoring the output voltage. In the event that the primary LED network is disconnected from the LM3501-16, the output voltage will increase and be limited to 15.5V (typ.). There is a 900 mV hysteresis associated with this circuitry which will cause the output to fluctuate between 15.5V and 14.6V (typ.) if the primary network is disconnected. In the event that the network is reconnected regulation will begin at the appropriate output voltage. The 15.5V limit allows the use of 16V 1  $\mu$ F ceramic output capacitors creating an overall small solution for white LED applications.

In the event that the primary LED network is disconnected from the LM3501-21, the output voltage will increase and be limited to 20.5V (typ.). There is a 1V hysteresis associated with this circuitry which will cause the output to fluctuate between 20.5V and 19.5V (typ.) if the primary network is disconnected. In the event that the network is reconnected regulation will begin at the appropriate output voltage. The 20.5V limit allows the use of 25V 1 μF ceramic output capacitors.

## RELIABILITY AND THERMAL SHUTDOWN

The maximum continuous pin current for the 8 pin thin DSBGA package is 535 mA. When driving the device near its power output limits the  $V_{SW}$  pin can see a higher DC current than 535 mA (see [INDUCTOR SELECTION](#) section for average switch current). To preserve the long term reliability of the device the average switch current should not exceed 535 mA.

The LM3501 has an internal thermal shutdown function to protect the die from excessive temperatures. The thermal shutdown trip point is typically 150°C. There is a hysteresis of typically 35°C so the die temperature must decrease to approximately 115°C before the LM3501 will return to normal operation.

## INDUCTOR SELECTION

The inductor used with the LM3501 must have a saturation current greater than the cycle by cycle peak inductor current (see [Table 1](#) below). Choosing inductors with low DCR decreases power losses and increases efficiency.

The minimum inductor value required for the LM3501-16 can be calculated using the following equation:

$$L > \frac{V_{IN} R_{DSON}}{0.29} \left( \frac{D}{D'} - 1 \right) \quad (4)$$

The minimum inductor value required for the LM3501-21 can be calculated using the following equation:

$$L > \frac{V_{IN} R_{DSON}}{0.58} \left( \frac{D}{D'} - 1 \right) \quad (5)$$

For both equations above, L is in μH,  $V_{IN}$  is the input supply of the chip in Volts,  $R_{DSON}$  is the ON resistance of the NMOS power switch found in [Typical Performance Characteristics](#) in ohms and D is the duty cycle of the switching regulator. The above equation is only valid for D greater than or equal to 0.5. For applications where the minimum duty cycle is less than 0.5, a 22 μH inductor is the typical recommendation for use with most applications. Bench-level verification of circuit performance is required in these special cases, however. The duty cycle, D, is given by the following equation:

$$D' = \frac{V_{IN}}{V_{OUT}} = 1 - D \quad (6)$$

where  $V_{OUT}$  is the voltage at pin C1.

**Table 1. Typical Peak Inductor Current (mA)<sup>(1)</sup>**

VIN (V)	# LEDs (in series)	LED Current					
		15 mA	20 mA	30 mA	40 mA	50 mA	60 mA
2.7	2	82	100	134	160	204	234
	3	118	138	190	244	294	352
	4	142	174	244	322	X	X
	5	191	232	319	413	X	X
3.3	2	76	90	116	136	172	198
	3	110	126	168	210	250	290
	4	132	158	212	270	320	X
	5	183	216	288	365	446	X

(1)  $C_{IN} = C_{OUT} = 1 \mu F$ ,  $L = 22 \mu H$ , 160 mΩ DCR max. Coilcraft DT1608C-2232 and 3 LED applications: LM3501-16 or LM3501-21; LED  $V_F = 3.77V$  at 20mA;  $T_A = 25^\circ C$  4 LED applications: LM3501-16 or LM3501-21; LED  $V_F = 3.41V$  at 20mA;  $T_A = 25^\circ C$  5 LED applications: LM3501-21 only; LED  $V_F = 3.28V$  at 20mA;  $T_A = 25^\circ C$

**Table 1. Typical Peak Inductor Current (mA)<sup>(1)</sup> (continued)**

VIN (V)	# LEDs (in series)	LED Current					
		15 mA	20 mA	30 mA	40 mA	50 mA	60 mA
4.2	2	64	76	96	116	142	162
	3	102	116	148	180	210	246
	4	122	146	186	232	272	318
	5	179	206	263	324	388	456

The typical cycle-by-cycle peak inductor current can be calculated from the following equation:

$$I_{PK} \approx \frac{I_{OUT}}{\eta D'} + \frac{V_{IN} D}{2L F_{SW}} \quad (7)$$

where  $I_{OUT}$  is the total load current,  $F_{SW}$  is the switching frequency,  $L$  is the inductance and  $\eta$  is the converter efficiency of the total driven load. A good typical number to use for  $\eta$  is 0.8. The value of  $\eta$  can vary with load and duty cycle. The average inductor current, which is also the average  $V_{SW}$  pin current, is given by the following equation:

$$I_{L(AVE)} \approx \frac{I_{OUT}}{\eta D'} \quad (8)$$

The maximum output current capability of the LM3501 can be estimated with the following equation:

$$I_{OUT} \approx \eta D' \left( I_{CL} - \frac{V_{IN} D}{2L F_{SW}} \right) \quad (9)$$

where  $I_{CL}$  is the current limit. Some recommended inductors include but are not limited to:

Coilcraft DT1608C series

Coilcraft DO1608C series

TDK VLP4612 series

TDK VLP5610 series

TDK VLF4012A series

## CAPACITOR SELECTION

Choose low ESR ceramic capacitors for the output to minimize output voltage ripple. Multilayer X7R or X5R type ceramic capacitors are the best choice. For most applications, a 1  $\mu$ F ceramic output capacitor is sufficient.

Local bypassing for the input is needed on the LM3501. Multilayer X7R or X5R ceramic capacitors with low ESR are a good choice for this as well. A 1  $\mu$ F ceramic capacitor is sufficient for most applications. However, for some applications at least a 4.7  $\mu$ F ceramic capacitor may be required for proper startup of the LM3501. Using capacitors with low ESR decreases input voltage ripple. For additional bypassing, a 100 nF ceramic capacitor can be used to shunt high frequency ripple on the input. Some recommended capacitors include but are not limited to:

TDK C2012X7R1C105K

Taiyo-Yuden EMK212BJ105 G

## LAYOUT CONSIDERATIONS

The input bypass capacitor  $C_{IN}$ , as shown in [Figure 33](#), must be placed close to the device and connect between the  $V_{IN}$  and GND pins. This will reduce copper trace resistance which effects the input voltage ripple of the IC. For additional input voltage filtering, a 100 nF bypass capacitor can be placed in parallel with  $C_{IN}$  to shunt any high frequency noise to ground. The output capacitor,  $C_{OUT}$ , should also be placed close to the LM3501 and connected directly between the  $V_{OUT}$  and GND pins. Any copper trace connections for the  $C_{OUT}$  capacitor can increase the series resistance, which directly effects output voltage ripple and efficiency. The current setting

resistor,  $R_{LED}$ , should be kept close to the FB pin to minimize copper trace connections that can inject noise into the system. The ground connection for the current setting resistor should connect directly to the GND pin. The AGND pin should connect directly to the GND pin. Not connecting the AGND pin directly, as close to the chip as possible, may affect the performance of the LM3501 and limit its current driving capability. Trace connections made to the inductor should be minimized to reduce power dissipation, EMI radiation and increase overall efficiency. It is good practice to keep the  $V_{SW}$  routing away from sensitive pins such as the FB pin. Failure to do so may inject noise into the FB pin and affect the regulation of the device. See Figure 34 and Figure 35 for an example of a good layout as used for the LM3501 evaluation board.

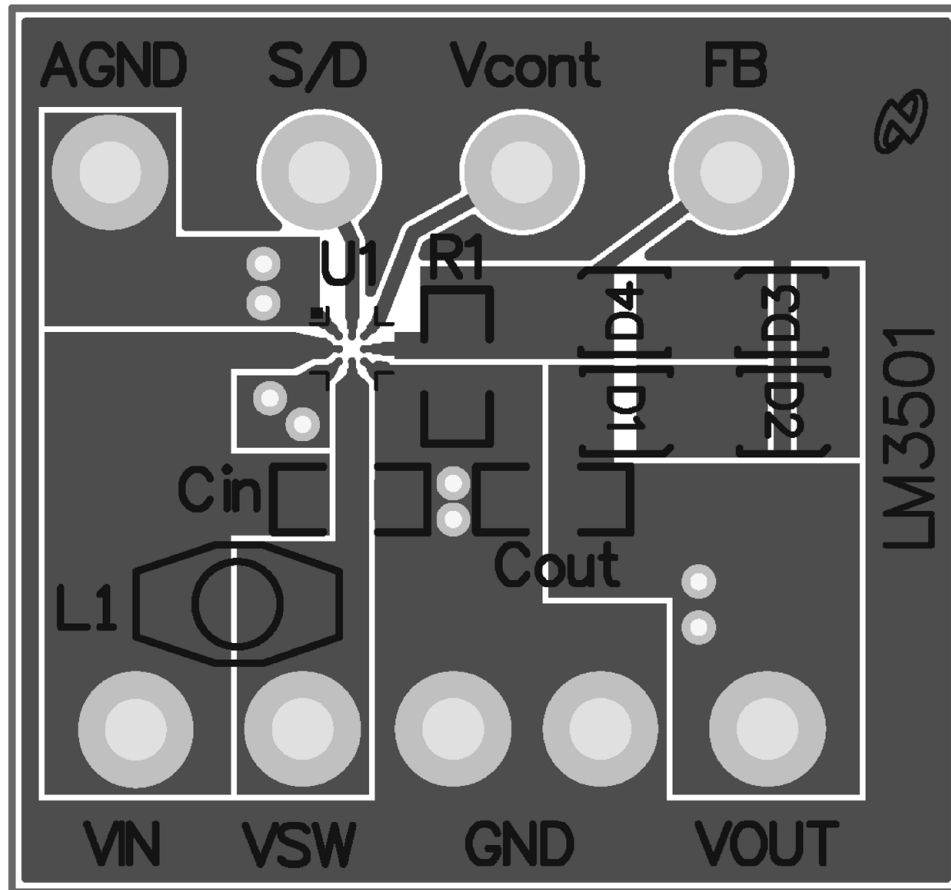

Figure 34. Evaluation Board Layout (2X Magnification)  
Top Layer

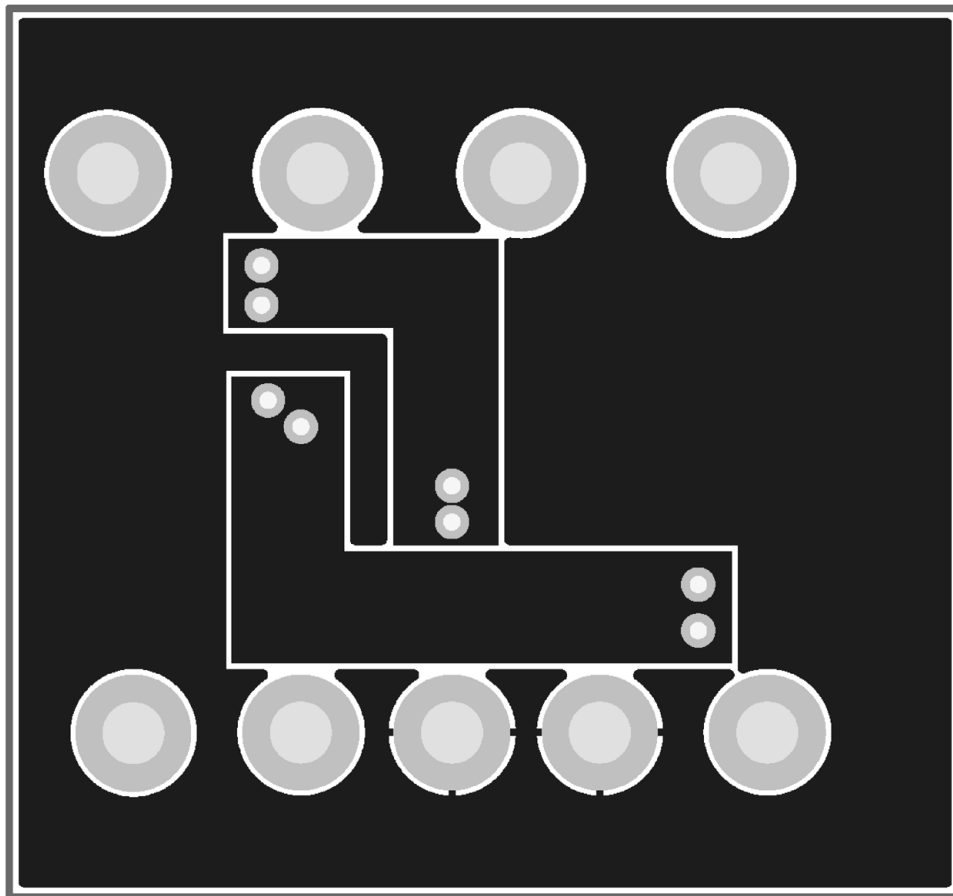

Figure 35. Evaluation Board Layout (2X Magnification) Bottom Layer (as viewed from the top)

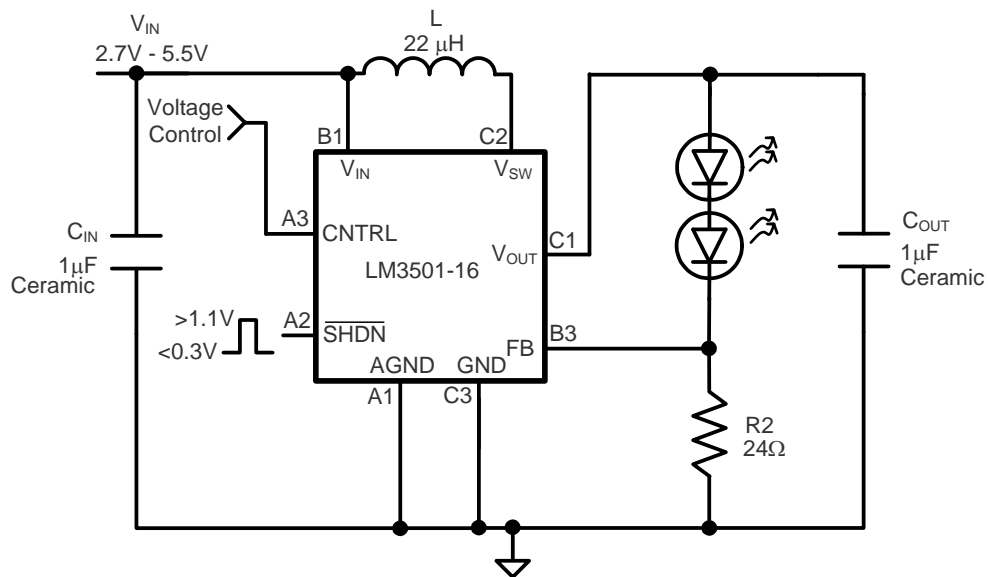

Figure 36. 2 White LED Application

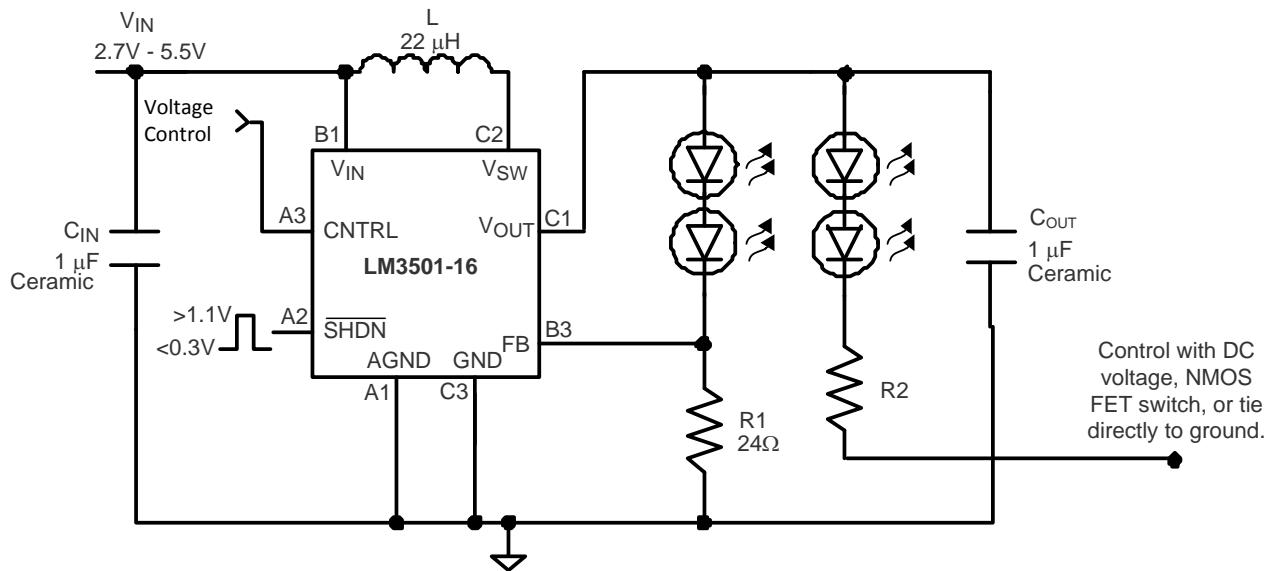

Figure 37. Multiple 2 LED String Application

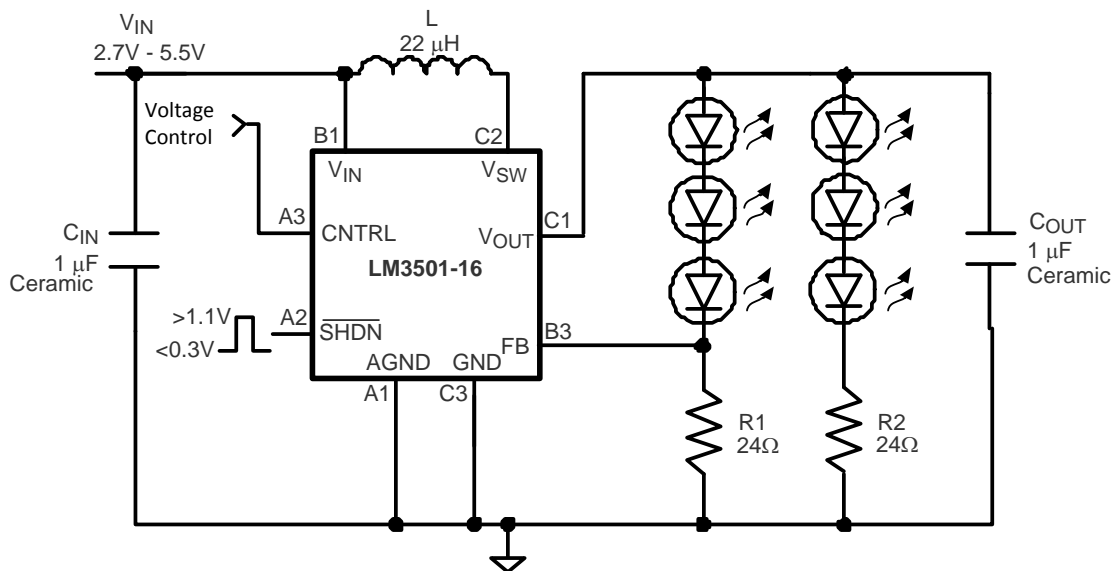

Figure 38. Multiple 3 LED String Application

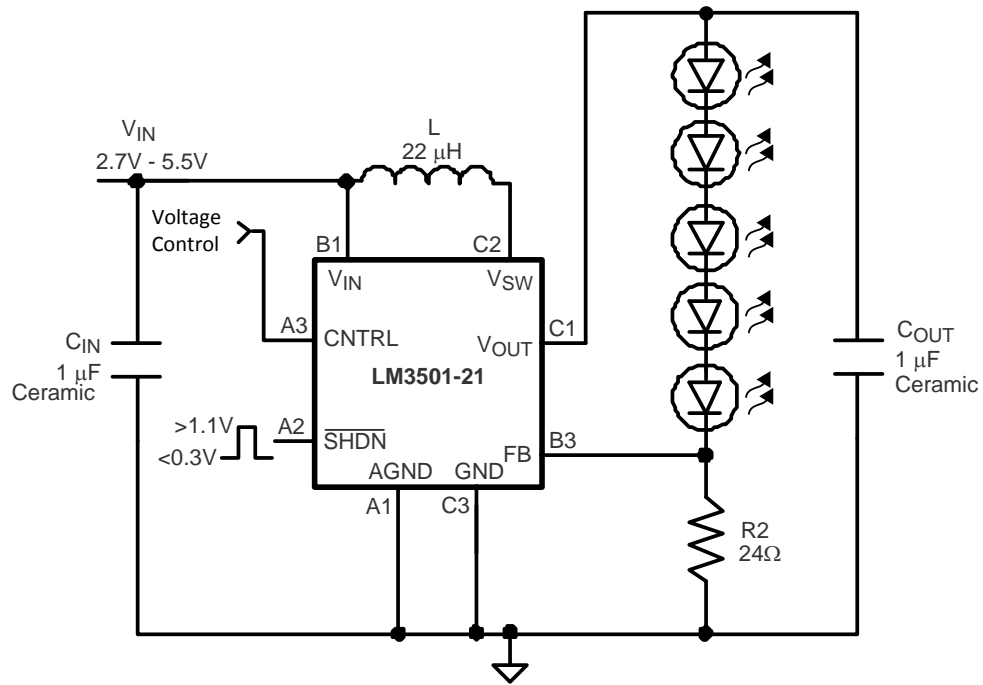

Figure 39. LM3501-21 5 LED Application

---

**REVISION HISTORY**

<b>Changes from Revision B (May 2013) to Revision C</b>	<b>Page</b>
• Changed layout of National Data Sheet to TI format .....	<a href="#">20</a>

---

**PACKAGING INFORMATION**

Orderable Device	Status (1)	Package Type	Package Drawing	Pins	Package Qty	Eco Plan (2)	Lead/Ball Finish (6)	MSL Peak Temp (3)	Op Temp (°C)	Device Marking (4/5)	Samples
LM3501TL-16/NOPB	ACTIVE	DSBGA	YZR	8	250	Green (RoHS & no Sb/Br)	SNAGCU	Level-1-260C-UNLIM	-40 to 85	S 19	<b>Samples</b>

(1) The marketing status values are defined as follows:

**ACTIVE:** Product device recommended for new designs.

**LIFEBUY:** TI has announced that the device will be discontinued, and a lifetime-buy period is in effect.

**NRND:** Not recommended for new designs. Device is in production to support existing customers, but TI does not recommend using this part in a new design.

**PREVIEW:** Device has been announced but is not in production. Samples may or may not be available.

**OBSELETE:** TI has discontinued the production of the device.

(2) Eco Plan - The planned eco-friendly classification: Pb-Free (RoHS), Pb-Free (RoHS Exempt), or Green (RoHS & no Sb/Br) - please check <http://www.ti.com/productcontent> for the latest availability information and additional product content details.

**TBD:** The Pb-Free/Green conversion plan has not been defined.

**Pb-Free (RoHS):** TI's terms "Lead-Free" or "Pb-Free" mean semiconductor products that are compatible with the current RoHS requirements for all 6 substances, including the requirement that lead not exceed 0.1% by weight in homogeneous materials. Where designed to be soldered at high temperatures, TI Pb-Free products are suitable for use in specified lead-free processes.

**Pb-Free (RoHS Exempt):** This component has a RoHS exemption for either 1) lead-based flip-chip solder bumps used between the die and package, or 2) lead-based die adhesive used between the die and leadframe. The component is otherwise considered Pb-Free (RoHS compatible) as defined above.

**Green (RoHS & no Sb/Br):** TI defines "Green" to mean Pb-Free (RoHS compatible), and free of Bromine (Br) and Antimony (Sb) based flame retardants (Br or Sb do not exceed 0.1% by weight in homogeneous material)

(3) MSL, Peak Temp. - The Moisture Sensitivity Level rating according to the JEDEC industry standard classifications, and peak solder temperature.

(4) There may be additional marking, which relates to the logo, the lot trace code information, or the environmental category on the device.

(5) Multiple Device Markings will be inside parentheses. Only one Device Marking contained in parentheses and separated by a "-" will appear on a device. If a line is indented then it is a continuation of the previous line and the two combined represent the entire Device Marking for that device.

(6) Lead/Ball Finish - Orderable Devices may have multiple material finish options. Finish options are separated by a vertical ruled line. Lead/Ball Finish values may wrap to two lines if the finish value exceeds the maximum column width.

**Important Information and Disclaimer:**The information provided on this page represents TI's knowledge and belief as of the date that it is provided. TI bases its knowledge and belief on information provided by third parties, and makes no representation or warranty as to the accuracy of such information. Efforts are underway to better integrate information from third parties. TI has taken and continues to take reasonable steps to provide representative and accurate information but may not have conducted destructive testing or chemical analysis on incoming materials and chemicals. TI and TI suppliers consider certain information to be proprietary, and thus CAS numbers and other limited information may not be available for release.

In no event shall TI's liability arising out of such information exceed the total purchase price of the TI part(s) at issue in this document sold by TI to Customer on an annual basis.



## TAPE AND REEL INFORMATION



### QUADRANT ASSIGNMENTS FOR PIN 1 ORIENTATION IN TAPE



\*All dimensions are nominal

Device	Package Type	Package Drawing	Pins	SPQ	Reel Diameter (mm)	Reel Width W1 (mm)	A0 (mm)	B0 (mm)	K0 (mm)	P1 (mm)	W (mm)	Pin1 Quadrant
LM3501TL-16/NOPB	DSBGA	YZR	8	250	178.0	8.4	2.08	2.08	0.76	4.0	8.0	Q1

TAPE AND REEL BOX DIMENSIONS



\*All dimensions are nominal

Device	Package Type	Package Drawing	Pins	SPQ	Length (mm)	Width (mm)	Height (mm)
LM3501TL-16/NOPB	DSBGA	YZR	8	250	210.0	185.0	35.0

YZR0008

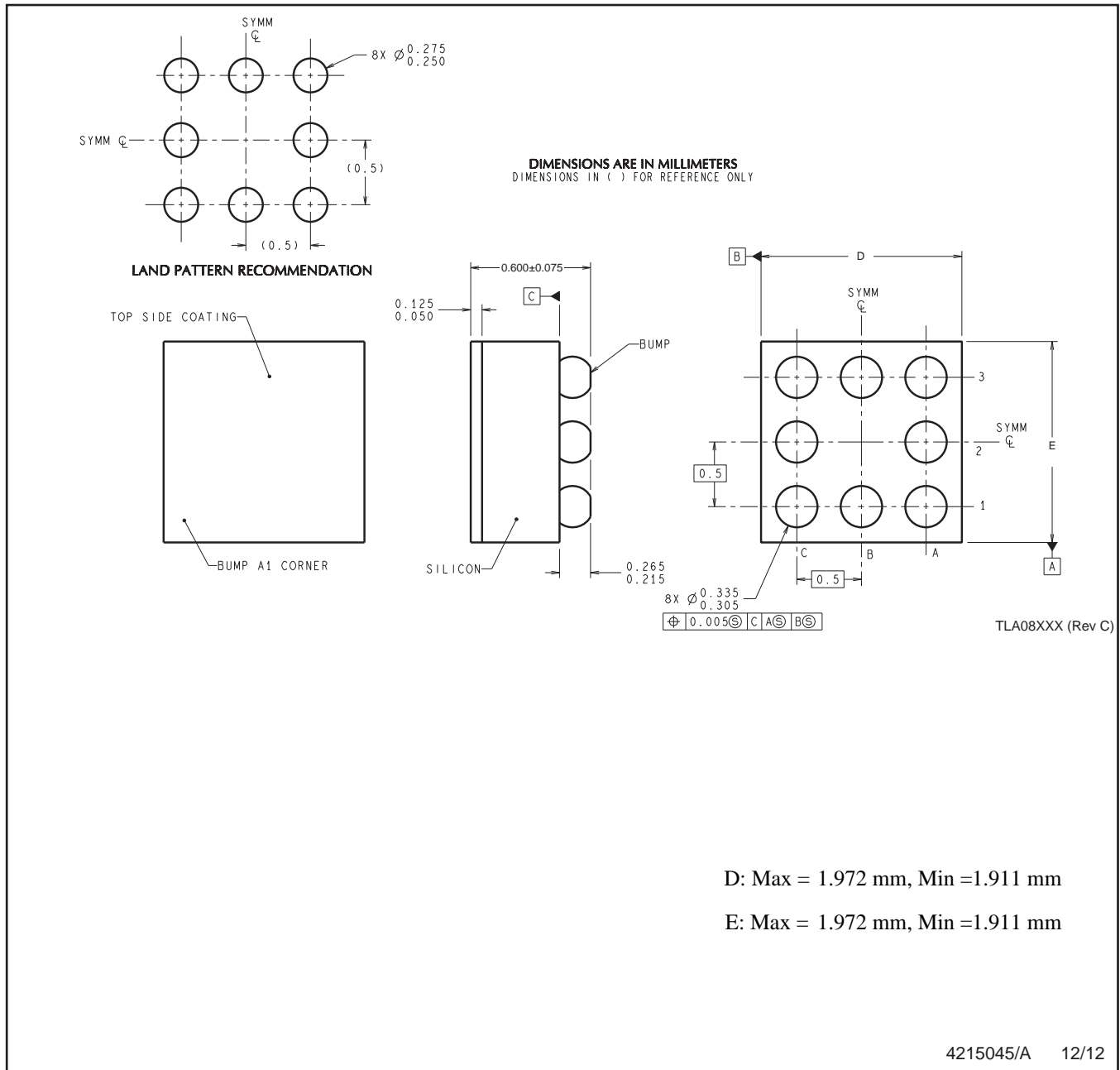

NOTES: A. All linear dimensions are in millimeters. Dimensioning and tolerancing per ASME Y14.5M-1994.  
B. This drawing is subject to change without notice.

4215045/A 12/12

## IMPORTANT NOTICE

Texas Instruments Incorporated (TI) reserves the right to make corrections, enhancements, improvements and other changes to its semiconductor products and services per JESD46, latest issue, and to discontinue any product or service per JESD48, latest issue. Buyers should obtain the latest relevant information before placing orders and should verify that such information is current and complete.

TI's published terms of sale for semiconductor products (<http://www.ti.com/sc/docs/stdterms.htm>) apply to the sale of packaged integrated circuit products that TI has qualified and released to market. Additional terms may apply to the use or sale of other types of TI products and services.

Reproduction of significant portions of TI information in TI data sheets is permissible only if reproduction is without alteration and is accompanied by all associated warranties, conditions, limitations, and notices. TI is not responsible or liable for such reproduced documentation. Information of third parties may be subject to additional restrictions. Resale of TI products or services with statements different from or beyond the parameters stated by TI for that product or service voids all express and any implied warranties for the associated TI product or service and is an unfair and deceptive business practice. TI is not responsible or liable for any such statements.

Buyers and others who are developing systems that incorporate TI products (collectively, "Designers") understand and agree that Designers remain responsible for using their independent analysis, evaluation and judgment in designing their applications and that Designers have full and exclusive responsibility to assure the safety of Designers' applications and compliance of their applications (and of all TI products used in or for Designers' applications) with all applicable regulations, laws and other applicable requirements. Designer represents that, with respect to their applications, Designer has all the necessary expertise to create and implement safeguards that (1) anticipate dangerous consequences of failures, (2) monitor failures and their consequences, and (3) lessen the likelihood of failures that might cause harm and take appropriate actions. Designer agrees that prior to using or distributing any applications that include TI products, Designer will thoroughly test such applications and the functionality of such TI products as used in such applications.

TI's provision of technical, application or other design advice, quality characterization, reliability data or other services or information, including, but not limited to, reference designs and materials relating to evaluation modules, (collectively, "TI Resources") are intended to assist designers who are developing applications that incorporate TI products; by downloading, accessing or using TI Resources in any way, Designer (individually or, if Designer is acting on behalf of a company, Designer's company) agrees to use any particular TI Resource solely for this purpose and subject to the terms of this Notice.

TI's provision of TI Resources does not expand or otherwise alter TI's applicable published warranties or warranty disclaimers for TI products, and no additional obligations or liabilities arise from TI providing such TI Resources. TI reserves the right to make corrections, enhancements, improvements and other changes to its TI Resources. TI has not conducted any testing other than that specifically described in the published documentation for a particular TI Resource.

Designer is authorized to use, copy and modify any individual TI Resource only in connection with the development of applications that include the TI product(s) identified in such TI Resource. NO OTHER LICENSE, EXPRESS OR IMPLIED, BY ESTOPPEL OR OTHERWISE TO ANY OTHER TI INTELLECTUAL PROPERTY RIGHT, AND NO LICENSE TO ANY TECHNOLOGY OR INTELLECTUAL PROPERTY RIGHT OF TI OR ANY THIRD PARTY IS GRANTED HEREIN, including but not limited to any patent right, copyright, mask work right, or other intellectual property right relating to any combination, machine, or process in which TI products or services are used. Information regarding or referencing third-party products or services does not constitute a license to use such products or services, or a warranty or endorsement thereof. Use of TI Resources may require a license from a third party under the patents or other intellectual property of the third party, or a license from TI under the patents or other intellectual property of TI.

TI RESOURCES ARE PROVIDED "AS IS" AND WITH ALL FAULTS. TI DISCLAIMS ALL OTHER WARRANTIES OR REPRESENTATIONS, EXPRESS OR IMPLIED, REGARDING RESOURCES OR USE THEREOF, INCLUDING BUT NOT LIMITED TO ACCURACY OR COMPLETENESS, TITLE, ANY EPIDEMIC FAILURE WARRANTY AND ANY IMPLIED WARRANTIES OF MERCHANTABILITY, FITNESS FOR A PARTICULAR PURPOSE, AND NON-INFRINGEMENT OF ANY THIRD PARTY INTELLECTUAL PROPERTY RIGHTS. TI SHALL NOT BE LIABLE FOR AND SHALL NOT DEFEND OR INDEMNIFY DESIGNER AGAINST ANY CLAIM, INCLUDING BUT NOT LIMITED TO ANY INFRINGEMENT CLAIM THAT RELATES TO OR IS BASED ON ANY COMBINATION OF PRODUCTS EVEN IF DESCRIBED IN TI RESOURCES OR OTHERWISE. IN NO EVENT SHALL TI BE LIABLE FOR ANY ACTUAL, DIRECT, SPECIAL, COLLATERAL, INDIRECT, PUNITIVE, INCIDENTAL, CONSEQUENTIAL OR EXEMPLARY DAMAGES IN CONNECTION WITH OR ARISING OUT OF TI RESOURCES OR USE THEREOF, AND REGARDLESS OF WHETHER TI HAS BEEN ADVISED OF THE POSSIBILITY OF SUCH DAMAGES.

Unless TI has explicitly designated an individual product as meeting the requirements of a particular industry standard (e.g., ISO/TS 16949 and ISO 26262), TI is not responsible for any failure to meet such industry standard requirements.



Where TI specifically promotes products as facilitating functional safety or as compliant with industry functional safety standards, such products are intended to help enable customers to design and create their own applications that meet applicable functional safety standards and requirements. Using products in an application does not by itself establish any safety features in the application. Designers must ensure compliance with safety-related requirements and standards applicable to their applications. Designer may not use any TI products in life-critical medical equipment unless authorized officers of the parties have executed a special contract specifically governing such use. Life-critical medical equipment is medical equipment where failure of such equipment would cause serious bodily injury or death (e.g., life support, pacemakers, defibrillators, heart pumps, neurostimulators, and implantables). Such equipment includes, without limitation, all medical devices identified by the U.S. Food and Drug Administration as Class III devices and equivalent classifications outside the U.S.

TI may expressly designate certain products as completing a particular qualification (e.g., Q100, Military Grade, or Enhanced Product). Designers agree that it has the necessary expertise to select the product with the appropriate qualification designation for their applications and that proper product selection is at Designers' own risk. Designers are solely responsible for compliance with all legal and regulatory requirements in connection with such selection.

Designer will fully indemnify TI and its representatives against any damages, costs, losses, and/or liabilities arising out of Designer's non-compliance with the terms and provisions of this Notice.

## Looking for pricing, stock, or lifecycle information?

Click below to explore more details on WIN SOURCE:

-  [View LM3501TL-16/NOPB on WIN SOURCE](#)
-  [Texas Instruments](#) Information

## Optimize Your Supply Chain with WIN SOURCE Solutions

-  Global Sourcing Solution
-  Obsolete Management
-  Cost Control Management
-  Shortage Management
-  Alternative Solution
-  Excess Inventory Management