



THE DATASHEET OF LM2754SQX/NOPB



LM2754 800mA Switched Capacitor Flash LED Driver with Time-Out Protection

Check for Samples: [LM2754](#)

FEATURES

- Up to 800mA Output Current
- Wide Operating Input Voltage Range: 2.8V to 5.5V
- Drives 1, 2, 3 or 4 LEDs in Parallel
- Ability to Disable One Current Sink Via the SEL Pin to Accommodate 3-LED Flash Modules
- Time-Out Circuitry Limits Flash Duration to 1 Second
- TX Input Ensures Synchronization with RF Power Amplifier Pulse
- Adaptive 1x, 1.5x and 2x Gains for Maximum Efficiency
- 1MHz Constant Frequency Operation
- Output Current Limit
- True Shutdown Output Disconnect
- $1\mu\text{A}$ Shutdown Current
- Internal Soft-Start Limits Inrush Current
- No Inductor Required
- Total Solution Size without LED <math><28\text{mm}^2</math>
- Low Profile 24-Pin WQFN Package (4mm x 4mm x 0.8mm)

APPLICATIONS

- Camera Flash in Mobile Phones
- Flash for Digital Cameras
- Supplies for DSP's, Microprocessors, Memory, MP3 Players, Pagers, Other Portable Devices

DESCRIPTION

The LM2754 is an integrated low noise, high current switched capacitor DC/DC converter with four regulated current sinks. The device is optimized for driving 1 to 4 high power white LEDs in parallel with a maximum current of 800mA. Maximum efficiency is achieved over the input voltage range by actively selecting the proper gain based on the LED forward voltage and current requirements.

Two external low power resistors set the desired current for Torch and Flash modes. The TX pin allows the device to be forced into Torch mode during a Flash pulse, allowing for synchronization between the RF power amplifier pulse and Flash/Torch modes. To protect the device and Flash LEDs, internal Time-Out circuitry turns off the LM2754 in case of a faulty prolonged Flash mode. Internal soft-start circuitry limits the amount of inrush current during start-up.

The LM2754 is available in a small 24-pin thermally enhanced WQFN package.

Typical Application Circuit

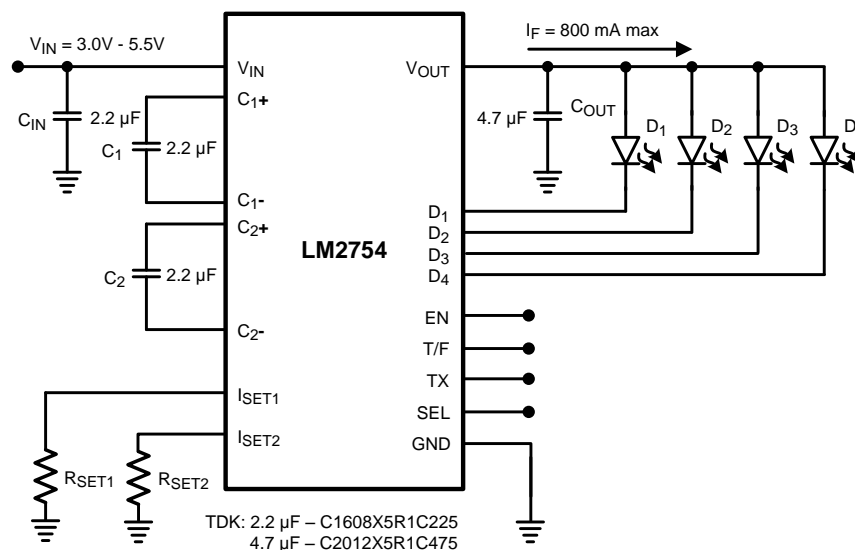

Please be aware that an important notice concerning availability, standard warranty, and use in critical applications of Texas Instruments semiconductor products and disclaimers thereto appears at the end of this data sheet.

All trademarks are the property of their respective owners.

Connection Diagram

24-pin No-Pullback Leadless Leadframe Package (WQFN-24) 4mm x 4mm x 0.8mm See Package Number RTW0024A

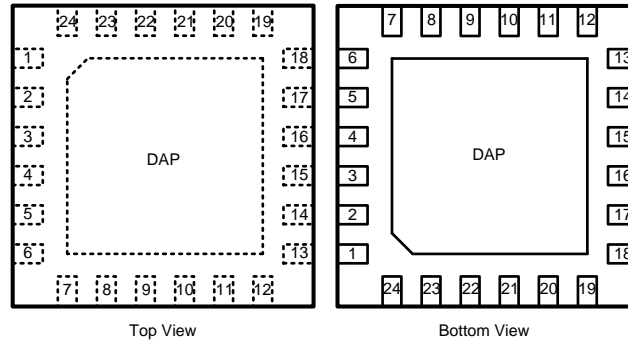

PIN DESCRIPTIONS

| Pin | Name | Description |
|----------------|---|---|
| 23,24 | V_{INSW} | Input Voltage Connection for Switch Array. Pins 23 and 24 are connected internally on the die. Connect V_{IN} and V_{INSW} pins together. |
| 22 | V_{IN} | Input Voltage Connection. Connect V_{IN} and V_{INSW} pins together. |
| 8 | V_{OUT} | Output Voltage. Connect to LED Anodes. |
| 12, 13, 14, 15 | D1, D2, D3, D4* | Regulated Current Sink Inputs. (* See SEL PIN description) |
| 1, 2, 7, 5 | C_{1+} , C_{1-} , C_{2+} , C_{2-} | Flying Capacitor Connections. |
| 3 | GND_{SW} | Switch Array Ground Connection. Connect GND and GND_{SW} pins together. |
| 9, 16, 17 | GND | Ground Connection. Connect GND and GND_{SW} pins together. |
| 21 | EN | Enable Control Pin. Logic High = Normal Operation in Torch Mode. Logic Low = Device Shut-Down. (See Note) |
| 20 | T/F | Torch/Flash Control Pin. Logic High = Flash Mode. Logic Low = Torch Mode. Device must be enabled for Torch or Flash to operate. (See Note) |
| 10, 11 | I_{SET1} , I_{SET2} | Current Set Resistor Connections. Connect 1% resistors to ground to set the desired current through the LEDs. LED current is approximated by the equation: $800 \times (1.25V \div R)$. This equation corresponds to the current through one current sink. Total LED current is equal to the sum of currents through all current sinks connected to the LED. The equation used for Torch (I_{SET1}) and Flash (I_{SET2}) resistors are the same. |
| 19 | TX | RF PA synchronization control pin. Logic High = Force Torch Mode. Logic Low = Normal Operation. (See APPLICATION INFORMATION Applications Information section for the full operational description) |
| 18 | SEL | D ₄ Control Pin. Logic Low = Normal 4-LED Operation. Logic High = Disable D ₄ LED Input. Connect D ₄ to V_{OUT} when not used. (See Note) |
| 4, 6 | No Connect | Do not connect to any node. |

Note: EN, T/F, TX, and SEL pins each have a 500kΩ resistor connected internally to GND



These devices have limited built-in ESD protection. The leads should be shorted together or the device placed in conductive foam during storage or handling to prevent electrostatic damage to the MOS gates.

Absolute Maximum Ratings ⁽¹⁾ ⁽²⁾ ⁽³⁾

| | |
|---|---|
| V_{IN} , V_{OUT} pins | -0.3V to 6.0V |
| EN, T/F, TX, SEL pins | -0.3V to ($V_{IN} + 0.3V$) w/ 6.0V max |
| Continuous Power Dissipation ⁽⁴⁾ | Internally Limited |
| Junction Temperature ($T_{J-MAX-ABS}$) | 150°C |
| Storage Temperature Range | -65°C to 150°C |
| Lead Temp. (Soldering, 5 sec.) | 260°C |
| ESD Rating ⁽⁵⁾ Human Body Model | 2kV |

- (1) Absolute Maximum Ratings indicate limits beyond which damage to the component may occur. Operating Ratings are conditions under which operation of the device is specified. Operating Ratings do not imply performance limits. For performance limits and associated test conditions, see the [Electrical Characteristics](#).
- (2) All voltages are with respect to the potential at the GND pin.
- (3) **If Military/Aerospace specified devices are required, please contact the Texas Instruments Sales Office / Distributors for availability and specifications.**
- (4) Internal thermal shutdown circuitry protects the device from permanent damage. Thermal shutdown engages at $T_J=150^\circ\text{C}$ (typ.) and disengages at $T_J = 120^\circ\text{C}$ (typ.).
- (5) The Human-body model is a 100 pF capacitor discharged through a 1.5k Ω resistor into each pin.

Operating Ratings ⁽¹⁾ ⁽²⁾

| | |
|--|-----------------|
| Input Voltage (V_{IN}) | 2.8V to 5.5V |
| Junction Temperature Range (T_J) | -40°C to +125°C |
| Ambient Temperature Range (T_A) ⁽³⁾ | -40°C to +85 °C |

- (1) Absolute Maximum Ratings indicate limits beyond which damage to the component may occur. Operating Ratings are conditions under which operation of the device is specified. Operating Ratings do not imply performance limits. For performance limits and associated test conditions, see the [Electrical Characteristics](#).
- (2) All voltages are with respect to the potential at the GND pin.
- (3) In applications where high power dissipation and/or poor package thermal resistance is present, the maximum ambient temperature may have to be derated. Maximum ambient temperature (T_{A-MAX}) is dependent on the maximum operation junction temperature ($T_{J-MAX-OP} = 125^\circ\text{C}$), the maximum power dissipation of the device in the application (P_{D-MAX}), and the junction-to ambient thermal resistance of the part/package in the application (θ_{JA}), as given by the following equation: $T_{A-MAX} = T_{J-MAX-OP} - (\theta_{JA} \times P_{D-MAX})$.

Thermal Information

| | |
|--|--------|
| Junction-to-Ambient Thermal Resistance, WQFN-24 Package (θ_{JA}) ⁽¹⁾ | 42°C/W |
|--|--------|

- (1) Junction-to-ambient thermal resistance (θ_{JA}) is taken from a thermal modeling result, performed under the conditions and guidelines set forth in the JEDEC standard JESD51-7. The test board is a 4 layer FR-4 board measuring 102mm x 76mm x 1.6mm. The 2 imbedded copper layers cover roughly the same area as the board. Thickness of copper layers are 70 μm /35 μm /35 μm /70 μm (2oz/1oz/1oz/2oz). Thermal vias are placed between the die attach pad in the 1st copper layer and the 2nd copper layer. Ambient temperature in simulation is 22°C, still air. Power dissipation is 1W. The value of θ_{JA} of the LM2754 in WQFN-24 could fall in a range as wide as 35°C/W to 150°C/W (if not wider), depending on PWB material, layout, and environmental conditions. In applications where high maximum power dissipation exists (high V_{IN} , high Gain, high I_{OUT}), special care must be paid to thermal dissipation issues. For more information on these topics, please refer to Application Note AN-1187 ([SNOA401](#)) and the [POWER EFFICIENCY](#) and [POWER DISSIPATION](#) sections of this datasheet.

Electrical Characteristics^{(1) (2)}

Limits in standard typeface are for $T_J = 25^\circ\text{C}$, and limits in **boldface** type apply over the full operating junction temperature range (-40°C to $+125^\circ\text{C}$). Unless otherwise noted, specifications apply to the LM2754 Typical Application Circuit (pg.1) with $V_{(IN, INSW)} = 3.6\text{V}$, $V_{EN} = 1.8\text{V}$, $V_{T/F} = 0\text{V}$, $V_{TX} = 0\text{V}$, $V_{SEL} = 0\text{V}$, $C_{IN} = C_1 = C_2 = 2.2\mu\text{F}$, $C_{OUT} = 4.7\mu\text{F}$.⁽³⁾

| Symbol | Parameter | Conditions | Min | Typ | Max | Units |
|-------------------|---|--|---------------|-------|---------------|---------------|
| V_{SETx} | I_{SETx} Pin Voltage | $R_{SETx} = 20\text{k}\Omega$ | -3.5% | 1.244 | +3.5% | V |
| I_{Dx}/I_{SETx} | LED Current to Set Current Ratio ⁽⁴⁾ | $I_{Dx} = 50\text{mA}$ to 100mA | -7% | 795 | +7% | mA/mA |
| | | $I_{Dx} = 200\text{mA}$ | -11.5% | 820 | +11.5% | |
| V_{HR} | Current Sink Headroom Voltage ⁽⁵⁾ | $I_{Dx} = 200\text{mA}$ | | 550 | | mV |
| | | $I_{Dx} = 50\text{mA}$ | | 150 | | |
| V_{OUT} | Output Voltage | 1x Mode, $I_{Dx} = 0\text{mA}$ | | 4.7 | | V |
| | | 1.5x Mode, $I_{Dx} = 0\text{mA}$ | | 4.7 | | |
| | | 2x Mode, $I_{Dx} = 0\text{mA}$ | | 5.1 | | |
| R_{OUT} | Output Impedance | 1x Mode | | 0.25 | | Ω |
| | | 1.5x Mode | | 1.3 | | |
| | | 2x Mode | | 1.5 | | |
| I_Q | Quiescent Supply Current | 1x Mode, $I_{Dx} = 0\text{mA}$ | | 0.7 | | mA |
| | | 1.5x Mode, $I_{Dx} = 0\text{mA}$ | | 3.4 | | |
| | | 2x Mode, $I_{Dx} = 0\text{mA}$ | | 6.3 | 8 | |
| I_{SD} | Shutdown Supply Current | $V_{EN} = 0\text{V}$ | | 0.1 | 1 | μA |
| f_{SW} | Switching Frequency | | 0.7 | 1 | 1.3 | MHz |
| V_{IH} | Logic Input High | Input Pins: EN, T/F, TX, SEL | 1.2 | | | V |
| V_{IL} | Logic Input Low | Input Pins: EN, T/F, TX, SEL | | | 0.4 | |
| I_{IH} | Logic Input High Current ⁽⁶⁾ | $V_{(EN, T/F, TX, SEL)} = 1.8\text{V}$ | | 4 | | μA |
| I_{IL} | Logic Input Low Current ⁽⁶⁾ | $V_{(EN, T/F, TX, SEL)} = 0\text{V}$ | | 0.5 | | μA |

(1) All voltages are with respect to the potential at the GND pin.

(2) Min and Max limits are specified by design, test, or statistical analysis. Typical numbers represent the most likely norm.

(3) C_{IN} , C_{OUT} , C_1 , C_2 : Low-ESR Surface-Mount Ceramic Capacitors (MLCCs) used in setting electrical characteristics

(4) I_{Dx}/I_{SETx} Ratio was tested with the Charge Pump in a gain of 1x.

(5) Headroom Voltage (V_{HR}) is the voltage across the current sinks (V_{Dx}) at which the current falls to 95% of the nominal programmed current. V_{HR} is measured from V_{Dx} to GND. If the headroom voltage requirement is not met, LED current regulation will be compromised.

(6) There is a 500k Ω resistor connected internally between each logic pin (EN, T/F, TX, SEL) and GND.

BLOCK DIAGRAM

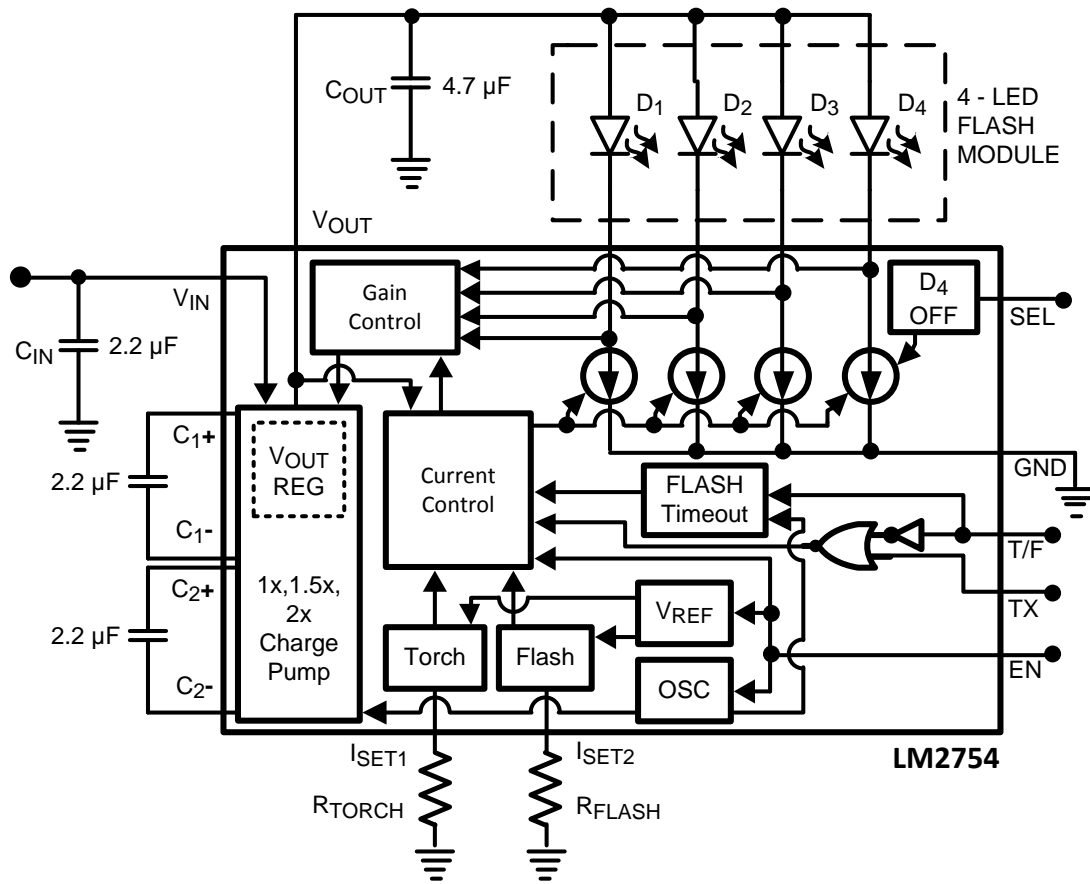

TYPICAL PERFORMANCE CHARACTERISTICS

Unless otherwise specified: $T_A = 25^\circ\text{C}$, $V_{Dx} = 1\text{V}$, $V_{(IN, INSW)} = 3.6\text{V}$, $V_{EN} = V_{IN}$, $V_{T/F} = V_{TX} = V_{SEL} = 0\text{V}$, $C_{IN} = C_1 = C_2 = 2.2\mu\text{F}$, $C_{OUT} = 4.7\mu\text{F}$. Capacitors are low-ESR multi-layer ceramic capacitors (MLCC's).

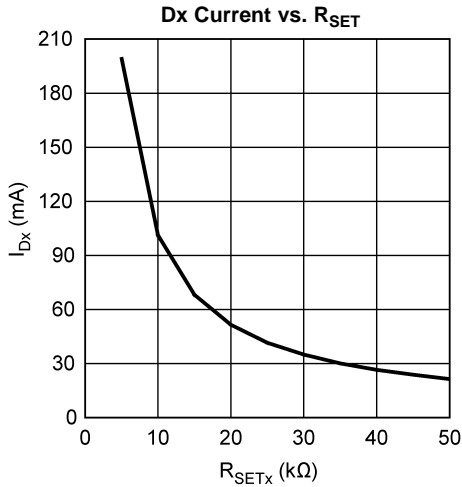

Figure 1.

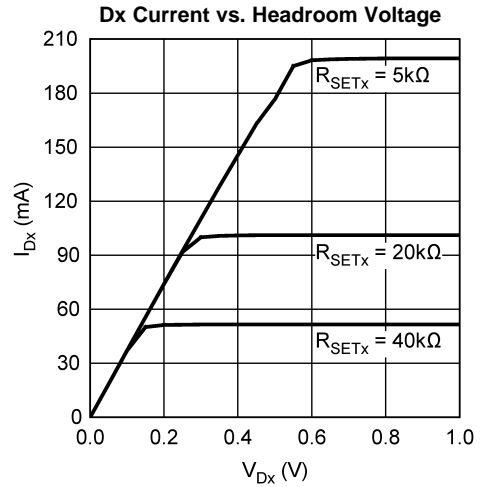

Figure 2.

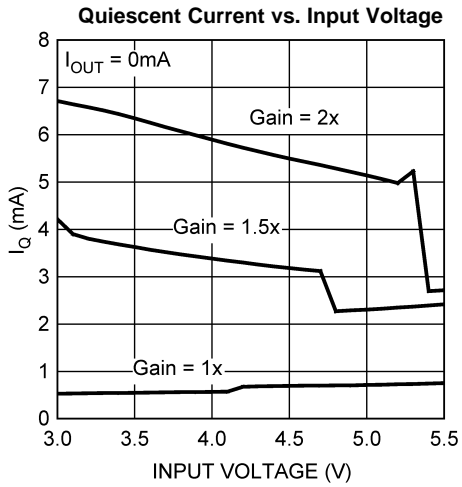

Figure 3.

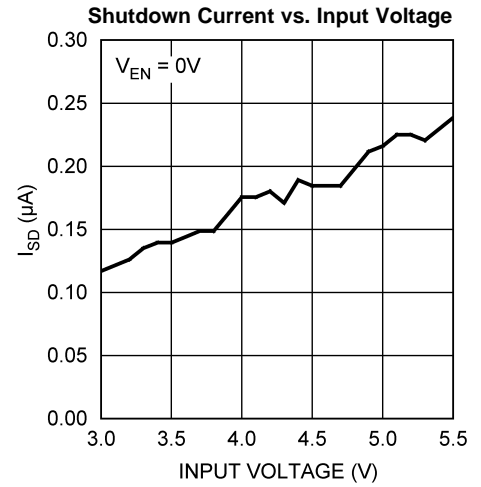

Figure 4.

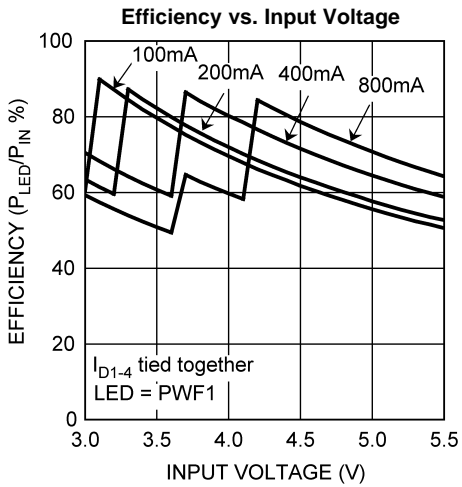

Figure 5.

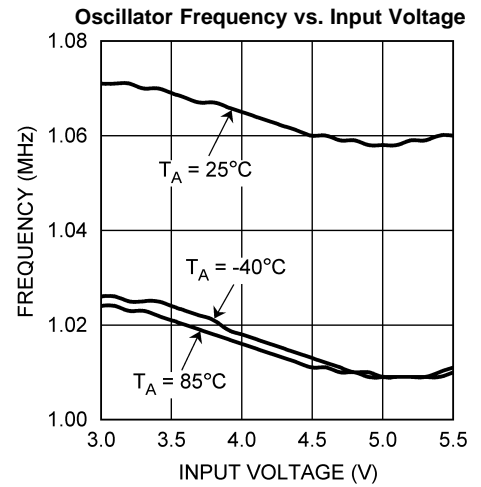
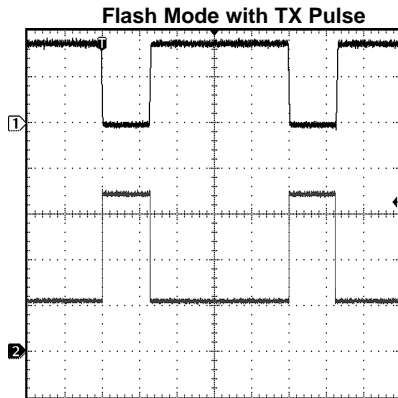

Figure 6.

TYPICAL PERFORMANCE CHARACTERISTICS (continued)

Unless otherwise specified: $T_A = 25^\circ\text{C}$, $V_{Dx} = 1\text{V}$, $V_{(IN, INSW)} = 3.6\text{V}$, $V_{EN} = V_{IN}$, $V_{T/F} = V_{TX} = V_{SEL} = 0\text{V}$, $C_{IN} = C_1 = C_2 = 2.2\mu\text{F}$, $C_{OUT} = 4.7\mu\text{F}$. Capacitors are low-ESR multi-layer ceramic capacitors (MLCC's).



$V_{IN} = 3.6\text{V}$, Load = 700mA (Flash), LED = PWF1
CH1 (TOP): V_{TX} ; Scale: 1V/Div, DC Coupled
CH2 (MIDDLE): I_{LED} ; Scale: 200mA/Div
Time scale: 1ms/Div

Figure 7.

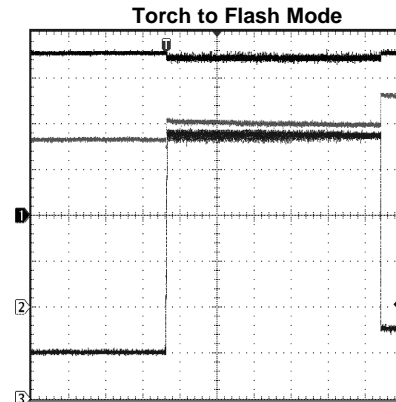

$V_{IN} = 3.6\text{V}$, Load = 200mA/800mA (Torch/Flash), LED = PWF1;
CH1 (TOP): V_{IN} ; Scale: 1V/Div, DC Coupled
CH2 (MIDDLE): V_{OUT} ; Scale: 1V/Div, DC Coupled
CH3 (BOTTOM): I_{IN} ; Scale: 200mA/Div
Time scale: 100ms/Div

Figure 8.

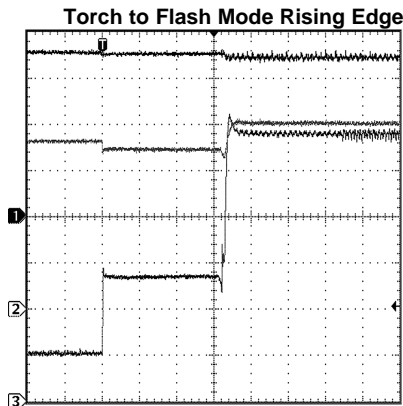

$V_{IN} = 3.6\text{V}$, Load = 200mA/800mA (Torch/Flash), LED = PWF1
CH1 (TOP): V_{IN} ; Scale: 1V/Div, DC Coupled
CH2 (MIDDLE): V_{OUT} ; Scale: 1V/Div, DC Coupled
CH3 (BOTTOM): I_{IN} ; Scale: 200mA/Div
Time scale: 400µs/Div

Figure 9.

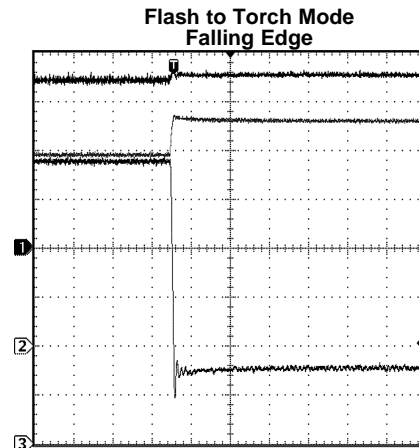

$V_{IN} = 3.6\text{V}$, Load = 800mA/200mA (Flash/Torch), LED = PWF1
CH1 (TOP): V_{IN} ; Scale: 1V/Div, DC Coupled
CH2 (MIDDLE): V_{OUT} ; Scale: 1V/Div, DC Coupled
CH3 (BOTTOM): I_{IN} ; Scale: 200mA/Div
Time scale: 100µs/Div

Figure 10.

TYPICAL PERFORMANCE CHARACTERISTICS (continued)

Unless otherwise specified: $T_A = 25^\circ\text{C}$, $V_{Dx} = 1\text{V}$, $V_{(IN, INSW)} = 3.6\text{V}$, $V_{EN} = V_{IN}$, $V_{T/F} = V_{TX} = V_{SEL} = 0\text{V}$, $C_{IN} = C_1 = C_2 = 2.2\mu\text{F}$, $C_{OUT} = 4.7\mu\text{F}$. Capacitors are low-ESR multi-layer ceramic capacitors (MLCC's).

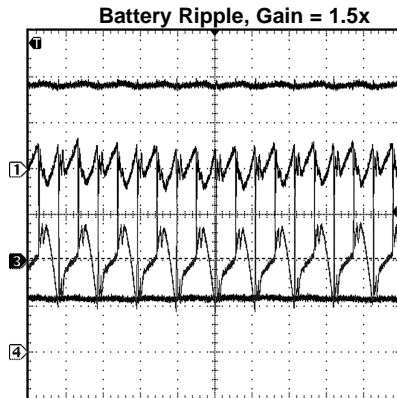

V_{IN} = Li-Ion Battery at 3.7V, Load = 400mA, LED = PWF1;
 CH1 (MID-TOP): V_{OUT} ; Scale: 20mV/Div, AC Coupled;
 CH2 (MID-BOTTOM): V_{IN} ; Scale: 50mV/Div, AC Coupled;
 CH3 (TOP): V_{IN} ; Scale: 1V/Div, DC Coupled;
 CH4 (BOTTOM): I_{IN} ; Scale: 500mA/Div;
 Time scale: 1 μs /Div

Figure 11.

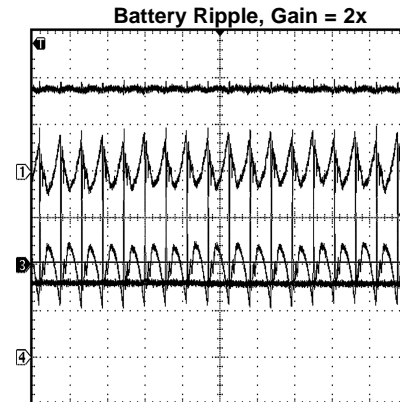

V_{IN} = Li-Ion Battery at 3.7V, Load = 400mA; LED = PWF1;
 CH1 (MID-TOP): V_{OUT} ; Scale: 20mV/Div, AC Coupled;
 CH2 (MID-BOTTOM): V_{IN} ; Scale: 50mV/Div, AC Coupled;
 CH3 (TOP): V_{IN} ; Scale: 1V/Div, DC Coupled;
 CH4 (BOTTOM): I_{IN} ; Scale: 500mA/Div; Time scale: 1 μs /Div

Figure 12.

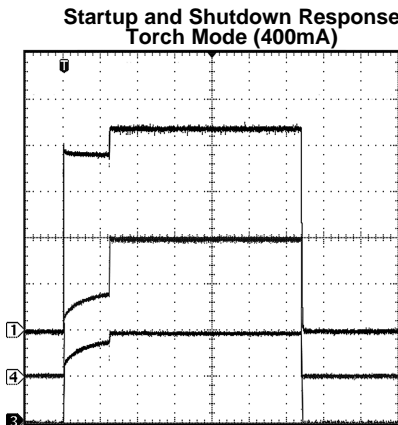

$V_{IN} = 3.6\text{V}$, Load = 400mA, LED = PWF1;
 CH1 (TOP): V_{OUT} ; Scale: 1V/Div, DC Coupled;
 CH4 (MIDDLE): I_{IN} ; Scale: 200mA/Div
 CH3 (BOTTOM): I_{OUT} ; Scale: 200mA/Div ;
 Time scale: 100ms/Div

Figure 13.

APPLICATION INFORMATION

CIRCUIT DESCRIPTION

The LM2754 is an adaptive 1x/1.5x/2x CMOS charge pump, optimized for driving Flash LEDs in camera phone and other portable applications. It provides four constant current inputs, each capable of sinking up to 200mA for Flash mode, and 100mA for Torch mode.

Each LED is driven from V_{OUT} and connected to one of the four current sinks. LED drive current for Torch mode is programmed by connecting a resistor, R_{SET1} , to the current set pin, I_{SET1} . LED drive current for Flash mode is set by connecting a resistor, R_{SET2} , to the current set pin, I_{SET2} . Torch mode is enabled by the EN pin, and the transition from Torch to Flash mode is controlled by the T/F pin. This device also has an option to disable the D_4 current sink via the SEL pin, for Flash LED modules with only 3 LEDs.

To prevent high battery load during a simultaneous RF PA transmission pulse and Flash condition, this device has a Flash interrupt pin (TX) to reduce the LED current to the Torch mode level for the duration of the RF PA transmission pulse.

CHARGE PUMP

The input to the 1x/1.5x/2x charge pump is connected to the V_{IN} pin, and the loosely regulated output of the charge pump is connected to the V_{OUT} pin. The device's loosely-regulated charge pump has both open loop and closed loop modes of operation. Under no-load conditions, open loop operation occurs when V_{OUT} is equal to the product of the input voltage and the charge pump gain, and is less than the nominal output regulation voltage. Over the recommended input voltage range of 3.0V to 5.5V, unloaded open loop operation will only occur in 1x and 1.5x gains. When the LM2754 is in closed loop operation with no-load, the voltage at V_{OUT} is loosely regulated to 4.7V (typ.) for the 1x and 1.5x gains, and 5.1V (typ.) for the 2x gain. When under load, the voltage at V_{OUT} can be less than the target regulation voltage while the charge pump is still in closed loop operation. This is due to the load regulation topology of the LM2754.

The charge pump gain transitions are actively selected to maintain regulation based on LED forward voltage and load requirements. The charge pump only transitions to higher gains, from 1x to 1.5x and 1.5x to 2x. Each transition from one gain to the next takes 125ms (typ.) for Torch mode and 2ms (typ.) for Flash mode. Once the charge pump transitions to a higher gain, it will remain at that gain for as long as the device remains enabled. Shutting down and then re-enabling the device resets the gain mode to the minimum gain required to maintain the load.

SOFT START

The LM2754 contains internal soft-start circuitry to limit inrush currents when the part is enabled. Soft start is implemented internally with a controlled turn-on of the internal voltage reference.

CURRENT LIMIT PROTECTION

The LM2754 charge pump contains current limit protection circuitry that protects the device during V_{OUT} fault conditions where excessive current is drawn. Output current is limited to 1.2A (typ.).

LOGIC CONTROL PINS

There are 4 logic control pins for the LM2754. All pins are active-High logic (High = Function ON). There is an internal pull-down resistor (500k Ω typ.) connected between each logic pin and GND. The operating modes for the part function according to [Table 1](#):

Table 1. LM2754 Logic Control Pins

| EN | T/F | TX | SEL | Mode |
|----|-----|----|-----|---|
| 0 | X | X | X | Part in Shutdown |
| 1 | 0 | X | 0 | Part Enabled, Current set by R _{SET1} , D ₁₋₄ Active |
| 1 | 0 | X | 1 | Part Enabled, Current set by R _{SET1} , D ₁₋₃ Active, D ₄ Disabled |
| 1 | 1 | 0 | 0 | Part Enabled, Current set by R _{SET2} , D ₁₋₄ Active |
| 1 | 1 | 0 | 1 | Part Enabled, Current set by R _{SET2} , D ₁₋₃ Active, D ₄ Disabled |
| 1 | 1 | 1 | 0 | Part Enabled, Current set by R _{SET1} , TX signal from RF PA, D ₁₋₄ Active |
| 1 | 1 | 1 | 1 | Part Enabled, Current set by R _{SET1} , TX signal from RF PA, D ₁₋₃ Active, D ₄ Disabled |

EN PIN (TORCH)

The EN pin is the master enable pin for the part. When the voltage on this pin is Low (<0.4V), the part is in shutdown mode. In this mode, all internal circuitry is OFF, V_{OUT} is disconnected from the V_{IN}, and the part consumes very little supply current (<1µA typ.). When the voltage on the EN pin is High (>1.2V), the part will activate the charge pump and regulate the output voltage to its nominal value. When the output voltage reaches its regulation level, the current sinks will turn on and sink the current programmed by R_{SET1} (assuming the logic on T/F is Low). Enabling the device is also referred to as Torch Mode. For correct start-up sequencing, power must be applied to V_{IN} before a High logic signal is applied to the EN pin.

T/F PIN (FLASH) AND FLASH TIMEOUT

A logic Low (<0.4V) signal on the T/F pin disables the Flash mode, defaulting the current through the LEDs to the Torch level programmed by R_{SET1}. Applying a logic High (>1.2V) signal to T/F places the device in Flash mode, with the LED current set by R_{SET2}.

Flash Timeout Protection Circuitry disables the current sinks when the signal on T/F is held high for more than 1 second (typ). This prevents the device from self-heating due to the high power dissipation during Flash conditions. During the timeout condition, voltage will still be present on V_{OUT} but the current sinks will be shut off, resulting in no current through the Flash LEDs. When the device goes into a timeout condition, placing a logic Low signal on EN will reset the timeout and a subsequent logic High signal on EN will return the device to normal operation. Flash timeout is not active during TX mode.

TX PIN

The TX pin on the LM2754 disables the Flash operation during a RF PA transmission pulse, and sets the LED current to the Torch level programmed by R_{SET1} for the duration of that pulse. At the end of each transmission interrupt pulse signal on the TX pin, the LED current level returns to the Flash current level set by R_{SET2}. The TX pin responds to the typical logic High (>1.2V) and logic Low (<0.4V) signal levels. Flash Timeout is not active during the TX mode operation.

SEL PIN

Connecting the SEL pin to a logic Low (<0.4V) signal places the device in normal operation, with all 4 current sinks active. To accommodate Flash LED modules with only 3 LEDs, place a logic High (>1.2V) signal on the SEL pin to disable the current sink D₄. If only 3 current sinks are used, the 200mA per current sink recommendation still applies, and the maximum Flash current will be 600mA. Connect D₄ to V_{OUT} when the logic in the SEL pin is High. Optional use of the SEL pin is to reduce the LED current used for Torch or Flash by 25% for high battery load conditions.

SETTING LED CURRENTS

The current through the LEDs connected to D₁₋₄ can be set simply by connecting an appropriately sized resistor (R_{SETx}) between the I_{SET1} pin of the LM2754 and GND for Torch mode and the I_{SET2} pin and GND for Flash Mode. The LED currents are proportional to the current that flows out of the I_{SETx} pin and are a factor of approximately 800 times greater than the I_{SETx} current. The feedback loop of an internal amplifier sets the voltage of the I_{SET} pin to 1.25V (typ.). The statements above are simplified in the equations below:

$$I_{Dx} = 800 \times (V_{SET} / R_{SET}) \quad (1)$$

$$R_{SET} = 800 \times (1.25V / I_{Dx}) \quad (2)$$

The maximum recommended current through each current sink is 100mA during Torch mode and 200mA during Flash mode. Maximum recommended total Flash current with all 4 current sinks used is 800mA (max 200mA per current sink). Using the part in conditions where the junction temperature might rise above the rated maximum requires that the operating ranges and/or conditions be de-rated. The printed circuit board also must be carefully laid out to account for high thermal dissipation in the part.

PARALLEL DX OUTPUTS FOR INCREASED CURRENT DRIVE

Outputs D₁₋₄ may be connected together to drive a one or two LEDs at higher currents. In applications using a single LED, all four parallel current sinks of equal value drive the single LED. For this type of configuration, the LED current should be programmed so that the current through each of the outputs is 25% of the total desired LED current. For example, if 200mA is the desired drive current for the single LED, R_{SET} should be selected such that the current through each of the current sink inputs is 50mA. Similarly, if two LEDs are to be driven by pairing up the D₁₋₄ inputs (i.e D₁₋₂, D₃₋₄), R_{SET} should be selected such that the current through each current sink input is 50% of the desired LED current.

Connecting the outputs in parallel does not affect internal operation of the LM2754 and has no impact on the Electrical Characteristics and limits previously presented. The available diode output current, maximum diode voltage, and all other specifications provided in the [Electrical Characteristics](#) table apply to this parallel output configuration, just as they do to the standard 4-LED application circuit.

Maximum recommended LED current for any configuration is 200mA per current sink, and 800mA total. For situations where only 3 current sinks will be used for the application, see the **SEL PIN** operation section.

CAPACITOR SELECTION

The LM2754 requires 4 external capacitors for proper operation. Surface-mount multi-layer ceramic capacitors are recommended. These capacitors are small, inexpensive and have very low equivalent series resistance (ESR <20mΩ typ.). Tantalum capacitors, OS-CON capacitors, and aluminum electrolytic capacitors are not recommended for use with the LM2754 due to their high ESR, as compared to ceramic capacitors.

For most applications, ceramic capacitors with X7R or X5R temperature characteristic are preferred for use with the LM2754. These capacitors have tight capacitance tolerance (as good as ±10%) and hold their value over temperature (X7R: ±15% over -55°C to 125°C; X5R: ±15% over -55°C to 85°C).

Capacitors with Y5V or Z5U temperature characteristic are generally not recommended for use with the LM2754. Capacitors with these temperature characteristics typically have wide capacitance tolerance (+80%, -20%) and vary significantly over temperature (Y5V: +22%, -82% over -30°C to +85°C range; Z5U: +22%, -56% over +10°C to +85°C range). Under some conditions, a nominal 1μF Y5V or Z5U capacitor could have a capacitance of only 0.1μF. Such detrimental deviation is likely to cause Y5V and Z5U capacitors to fail to meet the minimum capacitance requirements of the LM2754.

The voltage rating of the output capacitor should be 10V or more. For example, a 10V 0603 4.7μF output capacitor (TDK C1608X5R1A475) is acceptable for use with the LM2754, as long as the capacitance on the output does not fall below a minimum of 3μF in the intended application. All other capacitors should have a voltage rating at or above the maximum input voltage of the application and should have a minimum capacitance of 1μF.

POWER EFFICIENCY

Efficiency of LED drivers is commonly taken to be the ratio of power consumed by the LEDs (P_{LED}) to the power drawn at the input of the part (P_{IN}). With a 1x/1.5x/2x charge pump, the input current is equal to the charge pump gain times the output current (total LED current). The efficiency of the LM2754 can be predicted as follows:

$$P_{LED} = N \times V_{LED} \times I_{LED} \quad (3)$$

$$P_{IN} = V_{IN} \times I_{IN} \quad (4)$$

$$P_{IN} = V_{IN} \times (\text{Gain} \times N \times I_{LED} + I_Q) \quad (5)$$

$$E = (P_{LED} \div P_{IN}) \quad (6)$$

For a simple approximation, the current consumed by internal circuitry (I_Q) can be neglected, and the resulting efficiency will become:

$$E = V_{LED} \div (V_{IN} \times \text{Gain}) \quad (7)$$

Neglecting I_Q will result in a slightly higher efficiency prediction, but this impact will be negligible due to the value of I_Q being very low compared to the typical Torch and Flash current levels (100-800mA). It is also worth noting that efficiency as defined here is in part dependent on LED voltage. Variation in LED voltage does not affect power consumed by the circuit and typically does not relate to the brightness of the LED. For an advanced analysis, it is recommended that power consumed by the circuit ($V_{IN} \times I_{IN}$) be evaluated rather than power efficiency.

THERMAL PROTECTION

Internal thermal protection circuitry disables the LM2754 when the junction temperature exceeds 150°C (typ.). This feature protects the device from being damaged by high die temperatures that might otherwise result from excessive power dissipation. The device will recover and operate normally when the junction temperature falls below 120°C (typ.). It is important that the board layout provide good thermal conduction to keep the junction temperature within the specified operating ratings.

POWER DISSIPATION

The power dissipation ($P_{DISSIPATION}$) and junction temperature (T_J) can be approximated with the equations below. P_{IN} is the power generated by the 1x/1.5x/2x charge pump, P_{LED} is the power consumed by the LEDs, T_A is the ambient temperature, and θ_{JA} is the junction-to-ambient thermal resistance for the WQFN-24 package. V_{IN} is the input voltage to the LM2754, V_{LED} is the nominal LED forward voltage, and I_{LED} is the programmed LED current.

$$P_{DISSIPATION} = P_{IN} - P_{LED} \quad (8)$$

$$= [\text{Gain} \times V_{IN} \times (4 \times I_{LED})] - (V_{LED} \times 4 \times I_{LED}) \quad (9)$$

$$T_J = T_A + (P_{DISSIPATION} \times \theta_{JA}) \quad (10)$$

The junction temperature rating takes precedence over the ambient temperature rating. The LM2754 may be operated outside the ambient temperature rating, so long as the junction temperature of the device does not exceed the maximum operating rating of 125°C. The maximum ambient temperature rating must be derated in applications where high power dissipation and/or poor thermal resistance causes the junction temperature to exceed 125°C.

PCB Layout Considerations

The WQFN is a leadframe based Chip Scale Package (CSP) with very good thermal properties. This package has an exposed DAP (die attach pad) at the center of the package measuring 2.6mm x 2.6mm. The main advantage of this exposed DAP is to offer lower thermal resistance when it is soldered to the thermal land on the PCB. For PCB layout, a 1:1 ratio between the package and the PCB thermal land is recommended. To further enhance thermal conductivity, the PCB thermal land may include vias to a ground plane. For more detailed instructions on mounting WQFN packages, please refer to Application Note AN-1187 ([SNOA401](#)).

REVISION HISTORY

| Changes from Original (May 2013) to Revision A | Page |
|--|--------------------------|
| <hr/> <ul style="list-style-type: none">• Changed layout of National Data Sheet to TI format | <hr/> 12 |

PACKAGING INFORMATION

| Orderable Device | Status (1) | Package Type | Package Drawing | Pins | Package Qty | Eco Plan (2) | Lead/Ball Finish (6) | MSL Peak Temp (3) | Op Temp (°C) | Device Marking (4/5) | Samples |
|------------------|---------------|--------------|-----------------|------|-------------|-------------------------|-------------------------|----------------------|--------------|-------------------------|----------------|
| LM2754SQ/NOPB | ACTIVE | WQFN | RTW | 24 | 1000 | Green (RoHS & no Sb/Br) | CU SN | Level-1-260C-UNLIM | -40 to 85 | LM2754 | Samples |

(1) The marketing status values are defined as follows:

ACTIVE: Product device recommended for new designs.

LIFEBUY: TI has announced that the device will be discontinued, and a lifetime-buy period is in effect.

NRND: Not recommended for new designs. Device is in production to support existing customers, but TI does not recommend using this part in a new design.

PREVIEW: Device has been announced but is not in production. Samples may or may not be available.

OBSELETE: TI has discontinued the production of the device.

(2) Eco Plan - The planned eco-friendly classification: Pb-Free (RoHS), Pb-Free (RoHS Exempt), or Green (RoHS & no Sb/Br) - please check <http://www.ti.com/productcontent> for the latest availability information and additional product content details.

TBD: The Pb-Free/Green conversion plan has not been defined.

Pb-Free (RoHS): TI's terms "Lead-Free" or "Pb-Free" mean semiconductor products that are compatible with the current RoHS requirements for all 6 substances, including the requirement that lead not exceed 0.1% by weight in homogeneous materials. Where designed to be soldered at high temperatures, TI Pb-Free products are suitable for use in specified lead-free processes.

Pb-Free (RoHS Exempt): This component has a RoHS exemption for either 1) lead-based flip-chip solder bumps used between the die and package, or 2) lead-based die adhesive used between the die and leadframe. The component is otherwise considered Pb-Free (RoHS compatible) as defined above.

Green (RoHS & no Sb/Br): TI defines "Green" to mean Pb-Free (RoHS compatible), and free of Bromine (Br) and Antimony (Sb) based flame retardants (Br or Sb do not exceed 0.1% by weight in homogeneous material)

(3) MSL, Peak Temp. - The Moisture Sensitivity Level rating according to the JEDEC industry standard classifications, and peak solder temperature.

(4) There may be additional marking, which relates to the logo, the lot trace code information, or the environmental category on the device.

(5) Multiple Device Markings will be inside parentheses. Only one Device Marking contained in parentheses and separated by a "-" will appear on a device. If a line is indented then it is a continuation of the previous line and the two combined represent the entire Device Marking for that device.

(6) Lead/Ball Finish - Orderable Devices may have multiple material finish options. Finish options are separated by a vertical ruled line. Lead/Ball Finish values may wrap to two lines if the finish value exceeds the maximum column width.

Important Information and Disclaimer:The information provided on this page represents TI's knowledge and belief as of the date that it is provided. TI bases its knowledge and belief on information provided by third parties, and makes no representation or warranty as to the accuracy of such information. Efforts are underway to better integrate information from third parties. TI has taken and continues to take reasonable steps to provide representative and accurate information but may not have conducted destructive testing or chemical analysis on incoming materials and chemicals. TI and TI suppliers consider certain information to be proprietary, and thus CAS numbers and other limited information may not be available for release.

In no event shall TI's liability arising out of such information exceed the total purchase price of the TI part(s) at issue in this document sold by TI to Customer on an annual basis.

TAPE AND REEL INFORMATION



QUADRANT ASSIGNMENTS FOR PIN 1 ORIENTATION IN TAPE



*All dimensions are nominal

| Device | Package Type | Package Drawing | Pins | SPQ | Reel Diameter (mm) | Reel Width W1 (mm) | A0 (mm) | B0 (mm) | K0 (mm) | P1 (mm) | W (mm) | Pin1 Quadrant |
|---------------|--------------|-----------------|------|------|--------------------|--------------------|---------|---------|---------|---------|--------|---------------|
| LM2754SQ/NOPB | WQFN | RTW | 24 | 1000 | 178.0 | 12.4 | 4.3 | 4.3 | 1.3 | 8.0 | 12.0 | Q1 |

TAPE AND REEL BOX DIMENSIONS

*All dimensions are nominal

| Device | Package Type | Package Drawing | Pins | SPQ | Length (mm) | Width (mm) | Height (mm) |
|---------------|--------------|-----------------|------|------|-------------|------------|-------------|
| LM2754SQ/NOPB | WQFN | RTW | 24 | 1000 | 210.0 | 185.0 | 35.0 |

RTW0024A

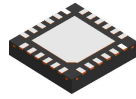

PACKAGE OUTLINE

WQFN - 0.8 mm max height

PLASTIC QUAD FLATPACK - NO LEAD

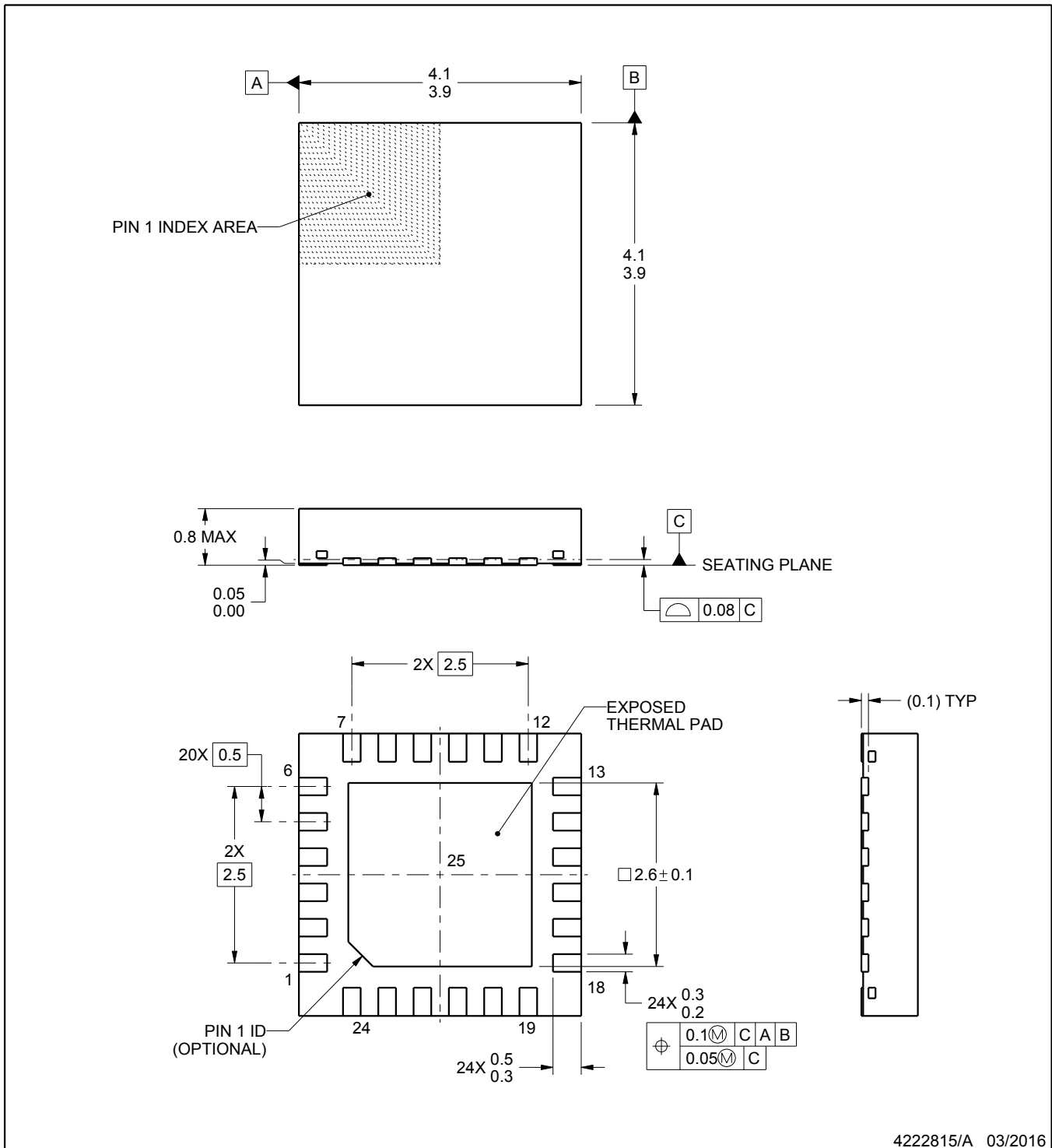

4222815/A 03/2016

NOTES:

1. All linear dimensions are in millimeters. Any dimensions in parenthesis are for reference only. Dimensioning and tolerancing per ASME Y14.5M.
2. This drawing is subject to change without notice.
3. The package thermal pad must be soldered to the printed circuit board for thermal and mechanical performance.

EXAMPLE BOARD LAYOUT

RTW0024A

WQFN - 0.8 mm max height

PLASTIC QUAD FLATPACK - NO LEAD

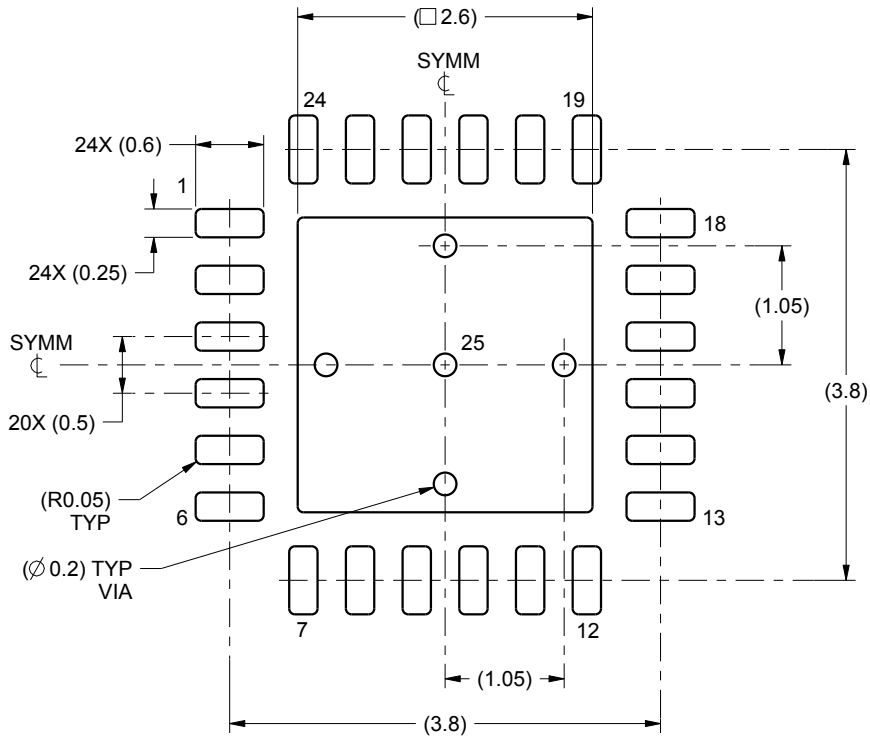

LAND PATTERN EXAMPLE
SCALE:15X

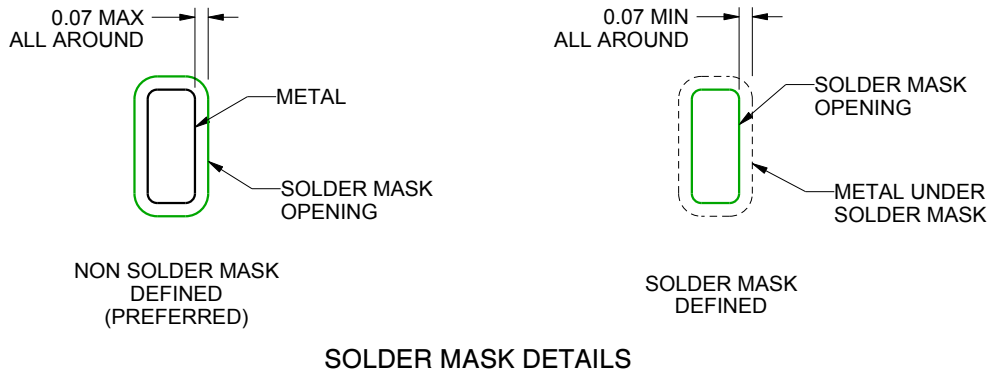

SOLDER MASK DETAILS

4222815/A 03/2016

NOTES: (continued)

4. This package is designed to be soldered to a thermal pad on the board. For more information, see Texas Instruments literature number SLUA271 (www.ti.com/lit/sluea271).

EXAMPLE STENCIL DESIGN

RTW0024A

WQFN - 0.8 mm max height

PLASTIC QUAD FLATPACK - NO LEAD

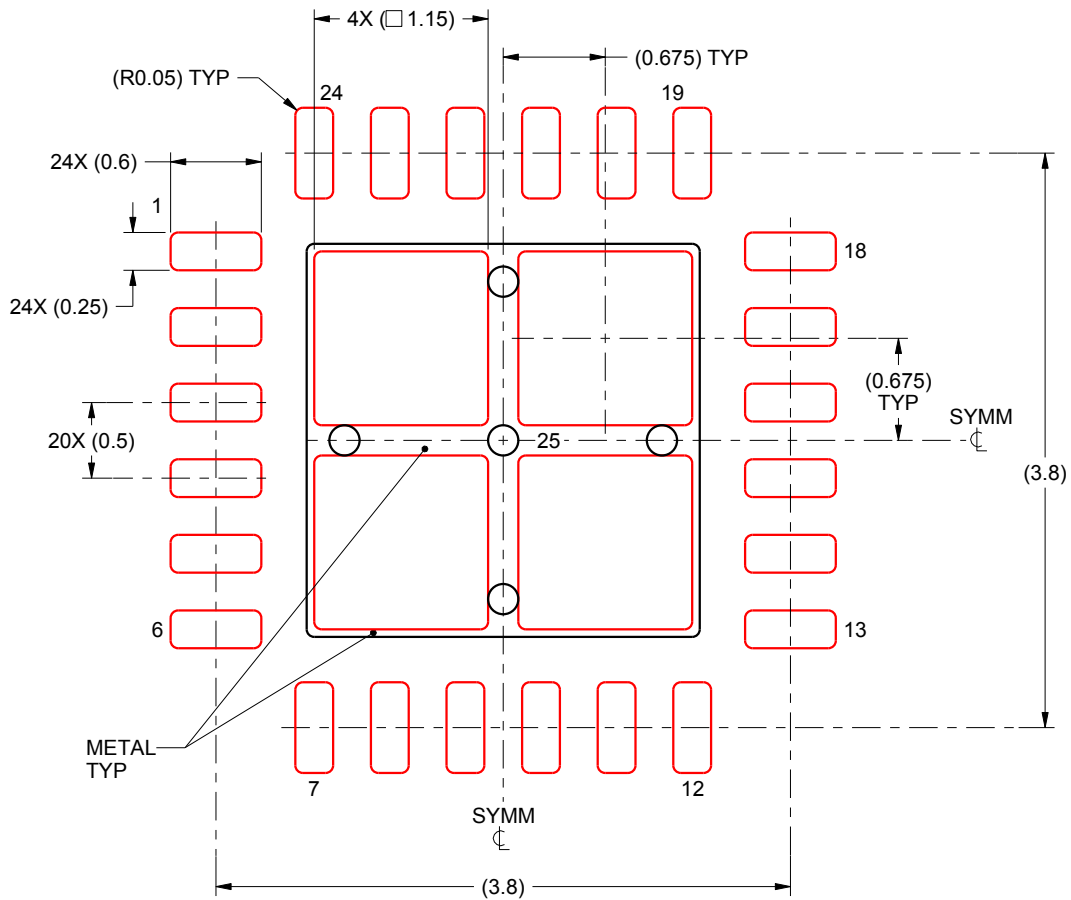

SOLDER PASTE EXAMPLE
BASED ON 0.125 mm THICK STENCIL

EXPOSED PAD 25:
78% PRINTED SOLDER COVERAGE BY AREA UNDER PACKAGE
SCALE:20X

4222815/A 03/2016

NOTES: (continued)

5. Laser cutting apertures with trapezoidal walls and rounded corners may offer better paste release. IPC-7525 may have alternate design recommendations.

IMPORTANT NOTICE

Texas Instruments Incorporated (TI) reserves the right to make corrections, enhancements, improvements and other changes to its semiconductor products and services per JESD46, latest issue, and to discontinue any product or service per JESD48, latest issue. Buyers should obtain the latest relevant information before placing orders and should verify that such information is current and complete.

TI's published terms of sale for semiconductor products (<http://www.ti.com/sc/docs/stdterms.htm>) apply to the sale of packaged integrated circuit products that TI has qualified and released to market. Additional terms may apply to the use or sale of other types of TI products and services.

Reproduction of significant portions of TI information in TI data sheets is permissible only if reproduction is without alteration and is accompanied by all associated warranties, conditions, limitations, and notices. TI is not responsible or liable for such reproduced documentation. Information of third parties may be subject to additional restrictions. Resale of TI products or services with statements different from or beyond the parameters stated by TI for that product or service voids all express and any implied warranties for the associated TI product or service and is an unfair and deceptive business practice. TI is not responsible or liable for any such statements.

Buyers and others who are developing systems that incorporate TI products (collectively, "Designers") understand and agree that Designers remain responsible for using their independent analysis, evaluation and judgment in designing their applications and that Designers have full and exclusive responsibility to assure the safety of Designers' applications and compliance of their applications (and of all TI products used in or for Designers' applications) with all applicable regulations, laws and other applicable requirements. Designer represents that, with respect to their applications, Designer has all the necessary expertise to create and implement safeguards that (1) anticipate dangerous consequences of failures, (2) monitor failures and their consequences, and (3) lessen the likelihood of failures that might cause harm and take appropriate actions. Designer agrees that prior to using or distributing any applications that include TI products, Designer will thoroughly test such applications and the functionality of such TI products as used in such applications.

TI's provision of technical, application or other design advice, quality characterization, reliability data or other services or information, including, but not limited to, reference designs and materials relating to evaluation modules, (collectively, "TI Resources") are intended to assist designers who are developing applications that incorporate TI products; by downloading, accessing or using TI Resources in any way, Designer (individually or, if Designer is acting on behalf of a company, Designer's company) agrees to use any particular TI Resource solely for this purpose and subject to the terms of this Notice.

TI's provision of TI Resources does not expand or otherwise alter TI's applicable published warranties or warranty disclaimers for TI products, and no additional obligations or liabilities arise from TI providing such TI Resources. TI reserves the right to make corrections, enhancements, improvements and other changes to its TI Resources. TI has not conducted any testing other than that specifically described in the published documentation for a particular TI Resource.

Designer is authorized to use, copy and modify any individual TI Resource only in connection with the development of applications that include the TI product(s) identified in such TI Resource. NO OTHER LICENSE, EXPRESS OR IMPLIED, BY ESTOPPEL OR OTHERWISE TO ANY OTHER TI INTELLECTUAL PROPERTY RIGHT, AND NO LICENSE TO ANY TECHNOLOGY OR INTELLECTUAL PROPERTY RIGHT OF TI OR ANY THIRD PARTY IS GRANTED HEREIN, including but not limited to any patent right, copyright, mask work right, or other intellectual property right relating to any combination, machine, or process in which TI products or services are used. Information regarding or referencing third-party products or services does not constitute a license to use such products or services, or a warranty or endorsement thereof. Use of TI Resources may require a license from a third party under the patents or other intellectual property of the third party, or a license from TI under the patents or other intellectual property of TI.

TI RESOURCES ARE PROVIDED "AS IS" AND WITH ALL FAULTS. TI DISCLAIMS ALL OTHER WARRANTIES OR REPRESENTATIONS, EXPRESS OR IMPLIED, REGARDING RESOURCES OR USE THEREOF, INCLUDING BUT NOT LIMITED TO ACCURACY OR COMPLETENESS, TITLE, ANY EPIDEMIC FAILURE WARRANTY AND ANY IMPLIED WARRANTIES OF MERCHANTABILITY, FITNESS FOR A PARTICULAR PURPOSE, AND NON-INFRINGEMENT OF ANY THIRD PARTY INTELLECTUAL PROPERTY RIGHTS. TI SHALL NOT BE LIABLE FOR AND SHALL NOT DEFEND OR INDEMNIFY DESIGNER AGAINST ANY CLAIM, INCLUDING BUT NOT LIMITED TO ANY INFRINGEMENT CLAIM THAT RELATES TO OR IS BASED ON ANY COMBINATION OF PRODUCTS EVEN IF DESCRIBED IN TI RESOURCES OR OTHERWISE. IN NO EVENT SHALL TI BE LIABLE FOR ANY ACTUAL, DIRECT, SPECIAL, COLLATERAL, INDIRECT, PUNITIVE, INCIDENTAL, CONSEQUENTIAL OR EXEMPLARY DAMAGES IN CONNECTION WITH OR ARISING OUT OF TI RESOURCES OR USE THEREOF, AND REGARDLESS OF WHETHER TI HAS BEEN ADVISED OF THE POSSIBILITY OF SUCH DAMAGES.

Unless TI has explicitly designated an individual product as meeting the requirements of a particular industry standard (e.g., ISO/TS 16949 and ISO 26262), TI is not responsible for any failure to meet such industry standard requirements.

Where TI specifically promotes products as facilitating functional safety or as compliant with industry functional safety standards, such products are intended to help enable customers to design and create their own applications that meet applicable functional safety standards and requirements. Using products in an application does not by itself establish any safety features in the application. Designers must ensure compliance with safety-related requirements and standards applicable to their applications. Designer may not use any TI products in life-critical medical equipment unless authorized officers of the parties have executed a special contract specifically governing such use. Life-critical medical equipment is medical equipment where failure of such equipment would cause serious bodily injury or death (e.g., life support, pacemakers, defibrillators, heart pumps, neurostimulators, and implantables). Such equipment includes, without limitation, all medical devices identified by the U.S. Food and Drug Administration as Class III devices and equivalent classifications outside the U.S.

TI may expressly designate certain products as completing a particular qualification (e.g., Q100, Military Grade, or Enhanced Product). Designers agree that it has the necessary expertise to select the product with the appropriate qualification designation for their applications and that proper product selection is at Designers' own risk. Designers are solely responsible for compliance with all legal and regulatory requirements in connection with such selection.

Designer will fully indemnify TI and its representatives against any damages, costs, losses, and/or liabilities arising out of Designer's non-compliance with the terms and provisions of this Notice.

Looking for pricing, stock, or lifecycle information?

Click below to explore more details on WIN SOURCE:

 [View LM2754SQX/NOPB on WIN SOURCE](#)

 [Texas Instruments](#) Information

Optimize Your Supply Chain with WIN SOURCE Solutions

-  Global Sourcing Solution
-  Obsolete Management
-  Cost Control Management
-  Shortage Management
-  Alternative Solution
-  Excess Inventory Management