



THE DATASHEET OF LM10CLN8



FEATURES

- Guaranteed Operation at +1.2V
- Op Amp and Reference on Single Chip
- Low Supply Current 400 μ A
- Capable of Floating Mode Operation
- Low Reference Drift 20ppm/ $^{\circ}$ C
- Low Offset Voltage
- Output Swings to Within 15mV of Rails

APPLICATIONS

- Remote Signal Conditioner / Transmitter
- Battery Operated Instruments
- Precision Current Regulators
- Precision Voltage Regulators
- Thermocouple Transmitter

DESCRIPTION

The LM10 combines a precision reference, a reference buffer amplifier and an independent, high quality op amp on a single chip. The device is capable of operation from a single supply as low as 1.1V, from dual supplies up to ± 20 V and typically draws 270 μ A supply current. Input voltage range for the op amp includes ground, while the unloaded output can swing to within 15mV of each rail. Further, the LM10 will deliver 20mA output current and still swing within ± 400 mV of the supply rails.

With its low operating current and floating operation capability, the LM10 is ideal for two wire analog transmitter circuits where the processed signal is carried on the same line used for power. The LM10 is suggested for portable battery powered equipment and is fully specified for operation from a single 1.2V battery. Other applications include precision current and voltage regulators, operating from very low voltages to several hundred volts.

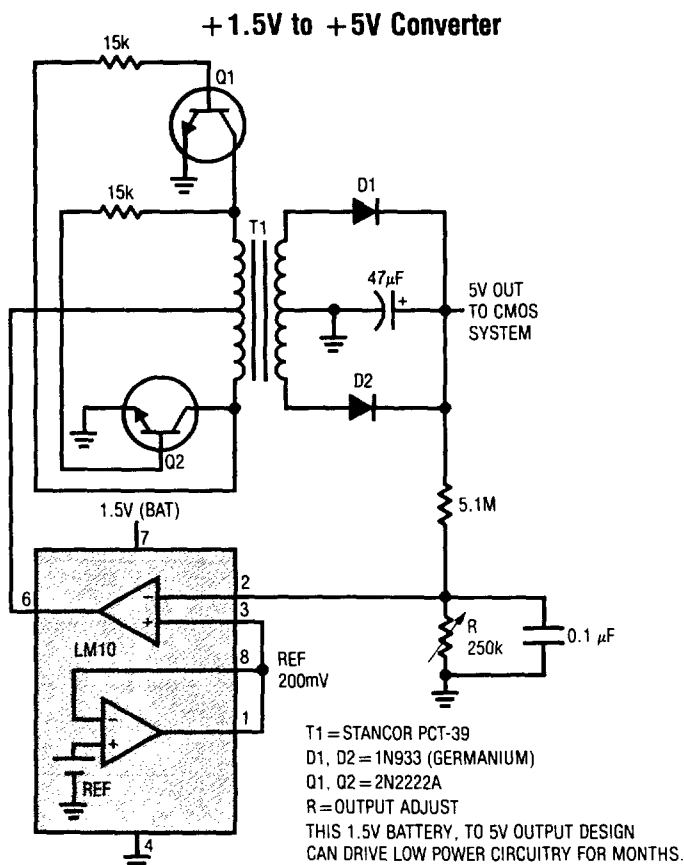

Line Regulation

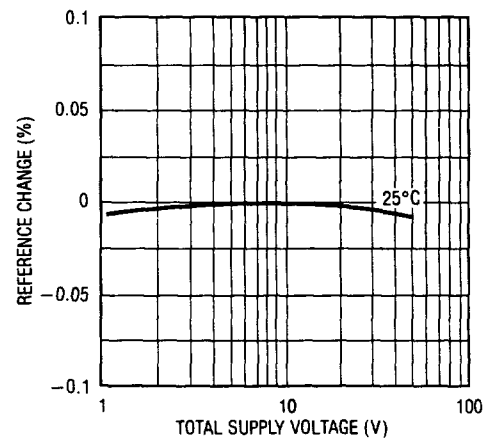

ABSOLUTE MAXIMUM RATINGS

Total Supply Voltage
 LM10/LM10B/LM10C 45V
 LM10BL/LM10CL 7V

Differential Input Voltage (Note 1)
 LM10/LM10B/LM10C ±40V
 LM10BL/LM10CL ±7V

Output Short Circuit Duration Indefinite

Operating Temperature Range (Note 2)
 LM10 -55°C ≤ T_A ≤ 125°C
 LM10B/LM10BL -25°C ≤ T_A ≤ 85°C
 LM10C/LM10CL 0°C ≤ T_A ≤ 70°C

Storage Temperature Range -65°C ≤ T_A ≤ 150°C

Lead Temperature (Soldering, 10 sec.) 300°C

PACKAGE/ORDER INFORMATION

TOP VIEW	ORDER PART NUMBER
<p>METAL CAN H PACKAGE</p>	LM10H LM10BH LM10CH LM10BLH LM10CLH
<p>J8 HERMETIC PACKAGE N8 PLASTIC DIP PACKAGE</p>	LM10CN8 LM10CLN8 LM10CJ8 LM10CLJ8 LM10J8 LM10BJ8 LM10BLJ8

OP AMP ELECTRICAL CHARACTERISTICS (Note 3)

SYMBOL	PARAMETER	CONDITIONS	LM10/LM10B			LM10C			UNITS
			MIN	TYP	MAX	MIN	TYP	MAX	
V _{OS}	Input Offset Voltage			0.3	2.0		0.5	4.0	mV
$\frac{\Delta V_{OS}}{\Delta Temp}$	Average Offset Voltage Drift			2.0	3.0		5.0	5.0	μV/°C
I _{OS}	Input Offset Current	(Note 4)		0.25	0.7		0.4	2.0	nA
$\frac{\Delta I_{OS}}{\Delta Temp}$	Offset Current Drift			2.0	1.5		5.0	3.0	pA/°C
I _B	Input Bias Current			10	20		12	30	nA
$\frac{\Delta I_B}{\Delta Temp}$	Bias Current Drift			60	30		90	40	pA/°C
A _{VOL}	Large Signal Voltage Gain	V _S = ±20V, I _{OUT} = 0, V _{OUT} = ±19.95V	●	120	400		80	400	V/mV
		V _S = ±20V, V _{OUT} = ±19.4V I _{OUT} = ±20mA	●	80			50		V/mV
		I _{OUT} = ±15mA	●	50	130		25	130	V/mV
			●	20			15		V/mV
		V _S = ±0.6V, I _{OUT} = ±2mA V _{OUT} = ±0.4V, V _{CM} = -0.4V		1.5	3.0		1.0	3.0	V/mV
		V _S = ±0.65V, I _{OUT} = ±2mA V _{OUT} = ±0.3V, V _{CM} = -0.4V	●	0.5			0.75		V/mV
	Shunt Gain (Note 5)	0.1mA ≤ I _{OUT} ≤ 5mA, R _L = 1.1kΩ		14	33		10	33	V/mV
		1.2V ≤ V _{OUT} ≤ 40V	●	6			6		V/mV
		1.3V ≤ V _{OUT} ≤ 40V	●	6			6		V/mV
		0.1mA ≤ I _{OUT} ≤ 20mA, R _L = 250Ω		8	25		6	25	V/mV
		1.5V ≤ V ⁺ ≤ 40V	●	4			4		V/mV

OP AMP ELECTRICAL CHARACTERISTICS (Note 3)

SYMBOL	PARAMETER	CONDITIONS	LM10/LM10B			LM10C			UNITS
			MIN	TYP	MAX	MIN	TYP	MAX	
CMRR	Common-Mode Rejection Ratio	$V_S = \pm 20V$ $-20V \leq V_{CM} \leq 19.15V$ $-20V \leq V_{CM} \leq 19V$	93	102		90	102		dB
			87			87			dB
PSRR	Power Supply Rejection Ratio	$-0.2V \geq V^- \geq -39V$ $V^+ = 1.0V$ $V^+ = 1.1V$	90	96		87	96		dB
			84			84			dB
		$V^- = -0.2V$ $1.0V \leq V^+ \leq 39.8V$ $1.1V \leq V^+ \leq 39.8V$	96	106		93	106		dB
			90			90			dB
R_{IN}	Input Resistance	(Note 6)	250	500		150	400		k Ω
			150			115			k Ω
I_S	Supply Current			270	400		300	500	μA
					500		570		μA
ΔI_S	Supply Current Change	$1.2V \leq V_S \leq 40V$ $1.3V \leq V_S \leq 40V$		15	75		15	75	μA
					75		75		μA

2

REFERENCE AMPLIFIER ELECTRICAL CHARACTERISTICS (Note 3)

SYMBOL	PARAMETER	CONDITIONS	LM10/LM10B			LM10C			UNITS
			MIN	TYP	MAX	MIN	TYP	MAX	
V_{REF}	Feedback Sense Voltage	Voltage at Pin 1 with Pin 1 Connected to Pin 8	195	200	205	190	200	210	mV
			194	200	206	189	200	211	mV
$\frac{\Delta V_{REF}}{\Delta Temp}$	Reference Drift			0.002			0.003	% / $^{\circ}C$	
	Feedback Current	Current into Pin 8		20	50		22	75	nA
					65			90	nA
	Line Regulation	$0 \leq I_{REF} \leq 1mA$, $V_{REF} = 200mV$ $1.2V \leq V_S \leq 40V$ $1.3V \leq V_S \leq 40V$		0.001	0.003		0.001	0.008	% / V
				0.001	0.006		0.001	0.01	% / V
	Load Regulation	$0 \leq I_{REF} \leq 1mA$ $V^+ - V_{REF} \geq 1.0V$ $V^+ - V_{REF} \geq 1.1V$		0.01	0.1		0.01	0.15	%
				0.01	0.15		0.01	0.20	%
	Reference Amplifier Gain	$0.2V \leq V_{REF} \leq 35V$	50	75		25	70		V/mV
			23			15			V/mV

OP AMP ELECTRICAL CHARACTERISTICS (Note 3)

SYMBOL	PARAMETER	CONDITIONS	LM10BL			LM10CL			UNITS
			MIN	TYP	MAX	MIN	TYP	MAX	
V_{OS}	Input Offset Voltage			0.3	2.0		0.5	4.0	mV mV
$\frac{\Delta V_{OS}}{\Delta Temp}$	Average Offset Voltage Drift			2.0			5.0		$\mu V/^\circ C$
I_{OS}	Input Offset Current	(Note 4)		0.1	0.7		0.2	2.0	nA nA
$\frac{\Delta I_{OS}}{\Delta Temp}$	Offset Current Drift			2.0			5.0		$\mu A/^\circ C$
I_B	Input Bias Current			10	20		12	30	nA nA
$\frac{\Delta I_B}{\Delta Temp}$	Bias Current Drift			60			90		$\mu A/^\circ C$
A_{VOL}	Large Signal Voltage Gain	$V_S = \pm 3.25V, I_{OUT} = 0, V_{OUT} = \pm 3.2V$		60	300		40	300	V/mV V/mV
		$V_S = \pm 3.25V, V_{OUT} = \pm 2.75V$ $I_{OUT} = \pm 10mA$		10	25		5	25	V/mV V/mV
		$I_{OUT} = \pm 2mA, V_{CM} = -0.4V$ $V_S = \pm 0.6V, V_{OUT} = \pm 0.4V$ $V_S = \pm 0.65V, V_{OUT} = \pm 0.3V$		1.5	3.0		1.0	3.0	V/mV V/mV
	Shunt Gain (Note 5)	$0.1mA \leq I_{OUT} \leq 10mA, R_L = 500\Omega$ $1.5V \leq V^+ \leq 6.5V$		8	30		6	30	V/mV V/mV
CMRR	Common-Mode Rejection Ratio	$V_S = \pm 3.25V$ $-3.25V \leq V_{CM} \leq 2.4V$ $-3.25V \leq V_{CM} \leq 2.25V$		89	102		80	102	dB dB
				83			74		
PSRR	Power Supply Rejection Ratio	$-0.2V \geq V^- \geq -5.4V$ $V^+ = 1.0V$ $V^+ = 1.2V$		86	96		80	96	dB dB
				80			74		
PSRR		$V^- = -0.2V$ $1.0V \leq V^+ \leq 6.3V$ $1.1V \leq V^+ \leq 6.3V$		94	106		80	106	dB dB
				88			74		
R_{IN}	Input Resistance	(Note 6)		250	500		150	400	k Ω k Ω
					150			115	
I_S	Supply Current			260	400		280	500	μA μA
					500			570	

REFERENCE AMPLIFIER ELECTRICAL CHARACTERISTICS (Note 3)

SYMBOL	PARAMETER	CONDITIONS	LM10BL			LM10CL			UNITS	
			MIN	TYP	MAX	MIN	TYP	MAX		
V_{REF}	Feedback Sense Voltage	Voltage at Pin 1 with Pin 1 Connected to Pin 8	●	195	200	205	190	200	210	mV
			●	194	200	206	189	200	211	mV
$\frac{\Delta V_{REF}}{\Delta Temp}$	Reference Drift		●	0.002			0.003			%/°C
			●	20			22			nA
	Feedback Current	Current into Pin 8	●	50			75			nA
			●	65			90			nA
	Line Regulation	$0 \leq I_{REF} \leq 0.5mA$, $V_{REF} = 200mV$ $1.2V \leq V_S \leq 6.5V$ $1.3V \leq V_S \leq 6.5V$	●	0.001 0.01			0.001 0.02			%/V
			●	0.001 0.02			0.001 0.03			%/V
	Load Regulation	$0 \leq I_{REF} \leq 0.5mA$ $V^+ - V_{REF} \geq 1.0V$ $V^+ - V_{REF} \geq 1.1V$	●	0.01 0.1			0.01 0.15			%
			●	0.01 0.15			0.01 0.20			%
	Reference Amplifier Gain	$0.2V \leq V_{REF} \leq 5.5V$	●	30	70		20	70		V/mV
			●	20			15			V/mV

The ● denotes the specifications which apply over full operating temperature range.

Note 1: The input voltage can exceed the supply voltages as long as the voltage from the input to any other terminal does not exceed the maximum differential voltage, and the maximum junction temperature is not exceeded due to the excess power dissipation that occurs when the input voltage is less than the negative supply voltage.

Note 2: The maximum operating junction temperatures are: 150°C for the LM10; 100°C for the LM10B and LM10BL; and 85°C for the LM10C and LM10CL. Package derating factors will be found on the back page of this data sheet.

Note 3: These specifications apply for the following conditions unless otherwise noted:

at 25°C

(a) $V^- \leq V_{CM} \leq V^+ - 0.85V$

(b) $1.2V \leq V_S \leq V_{MAX}$

over temperature

$V^- \leq V_{CM} \leq V^+ - 1.0V$

$1.3V \leq V_S \leq V_{MAX}$

$V_{REF} = 0.2V$ and $0 \leq I_{REF} \leq 1.0mA$ where $V_{MAX} = 40V$ for the LM10, LM10B and LM10C and $V_{MAX} = 6.5V$ for the LM10BL and LM10CL. The specifications do not include errors due to thermal gradients ($\tau_1 \approx 20ms$), die heating ($\tau_2 \approx 0.2$ sec) or package heating.

Note 4: For $T_J > 90^\circ C$, I_{OS} may exceed 1.5nA when $V_{CM} = V^-$. When the common-mode input voltage is within 100mV of the negative supply and $T_J = 125^\circ C$, the offset current will be less than 5nA.

Note 5: Shunt gain defines the operation in floating applications when the output is connected to the V^+ terminal and input common-mode is referred to V^- (see typical applications). The effects of larger output voltage swing with higher load resistance can be accounted for by adding the positive supply rejection error.

Note 6: Guaranteed by design.

TYPICAL PERFORMANCE CHARACTERISTICS (Op Amp)

Input Current

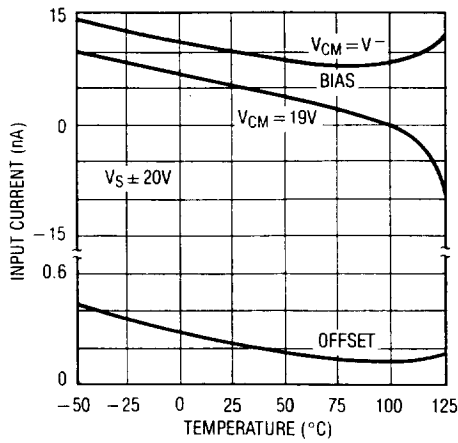

Common-Mode Limits

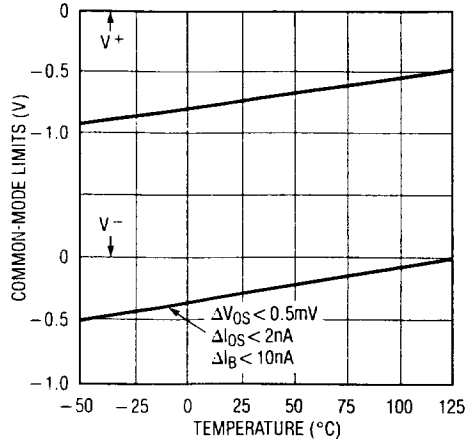

Offset Voltage Drift

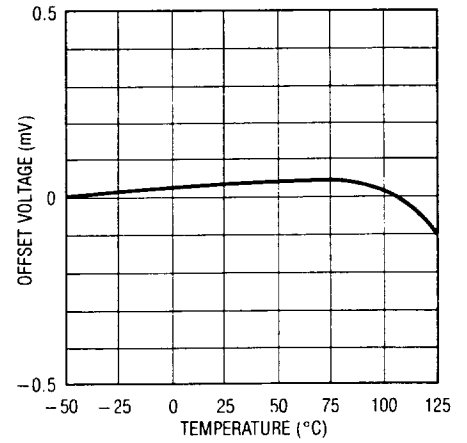

Input Noise Voltage

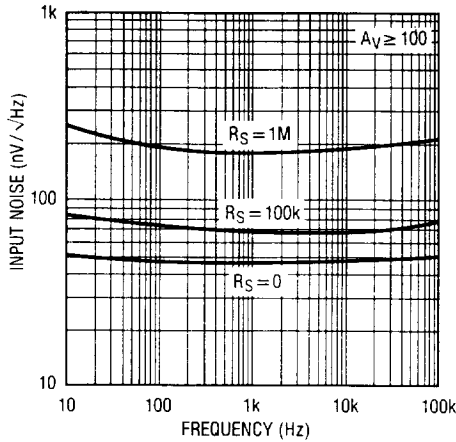

DC Voltage Gain

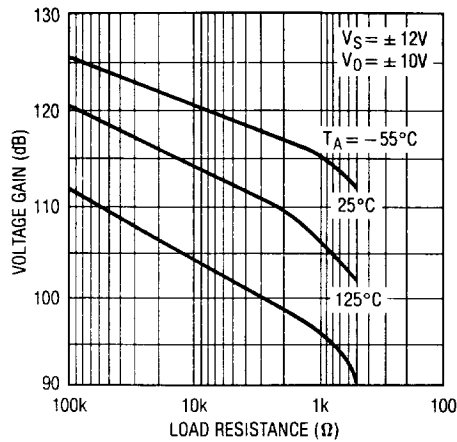

Transconductance

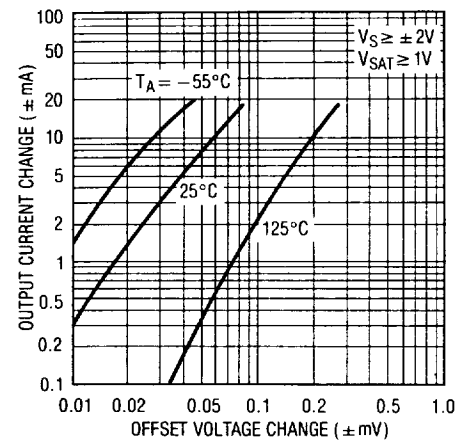

Output Saturation Characteristics

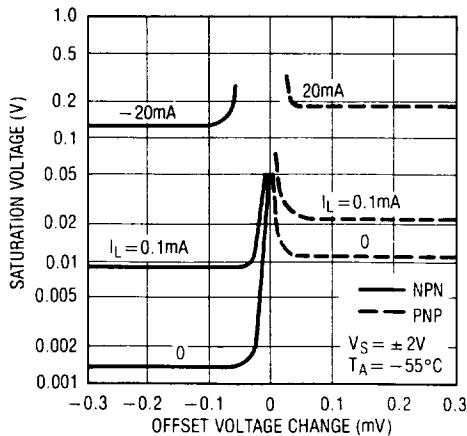

Output Saturation Characteristics

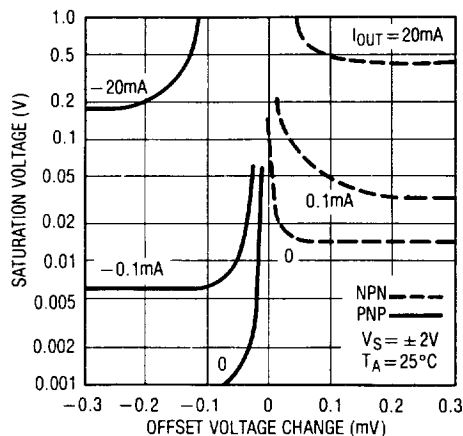

Output Saturation Characteristics

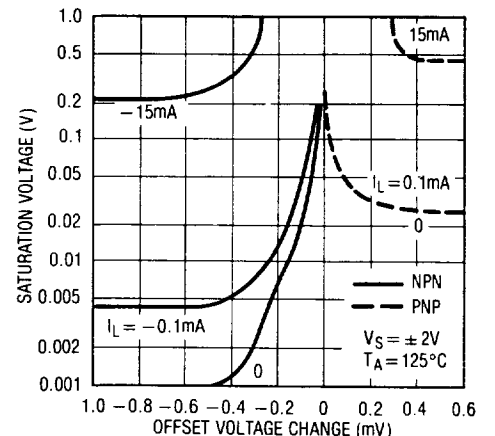

TYPICAL PERFORMANCE CHARACTERISTICS (Op Amp)

Minimum Supply Voltage

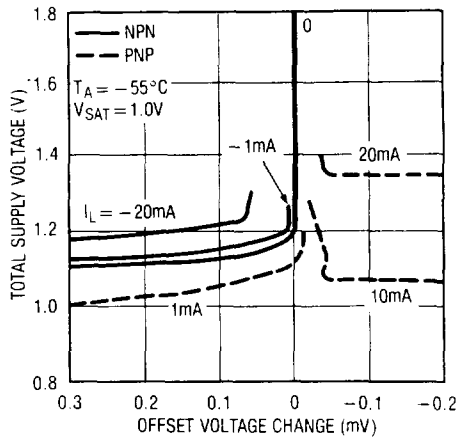

Minimum Supply Voltage

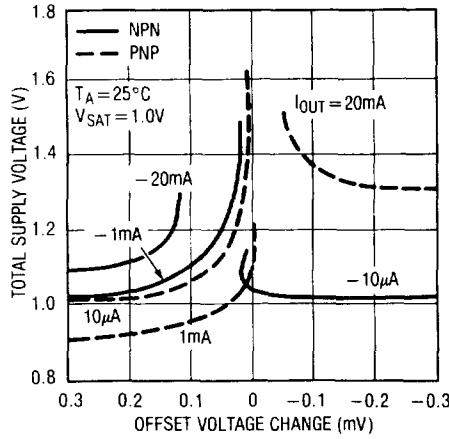

Minimum Supply Voltage

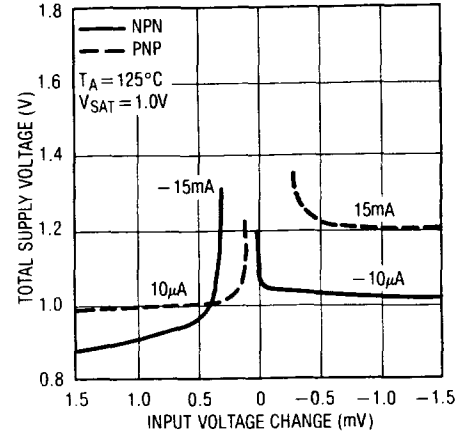

2

Frequency Response

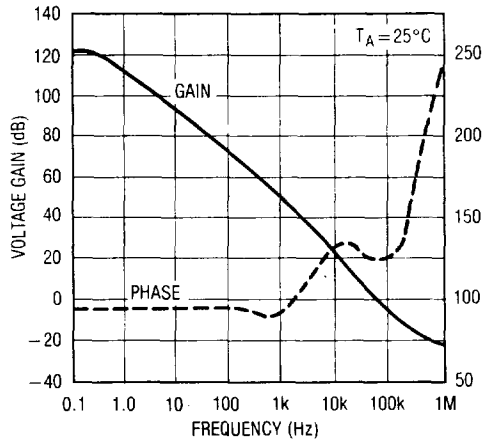

Output Impedance

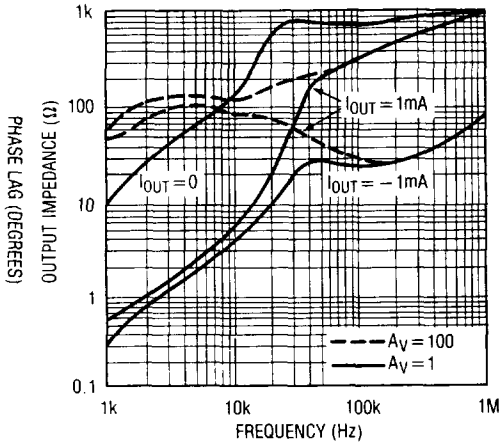

Typical Stability Range

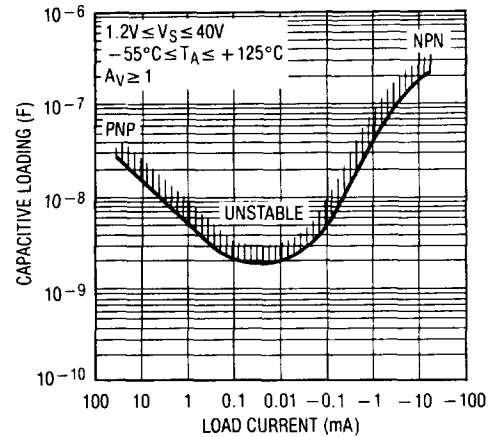

Large Signal Response

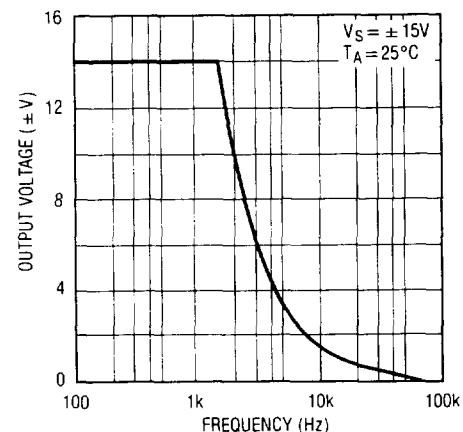

Comparator Response Time for Various Input Overdrives

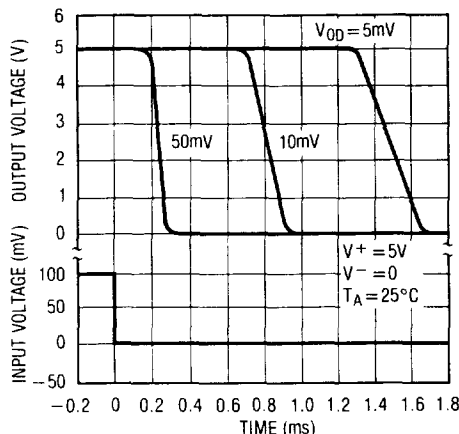

Comparator Response Time for Various Input Overdrives

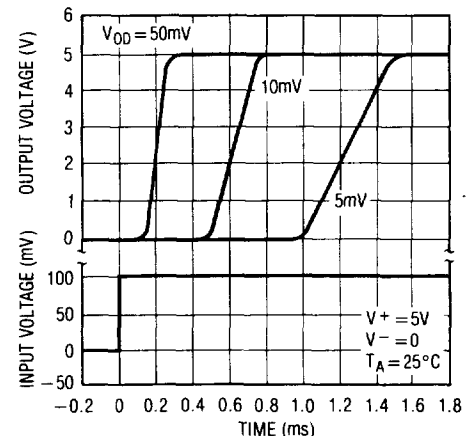

TYPICAL PERFORMANCE CHARACTERISTICS

Follower Pulse Response

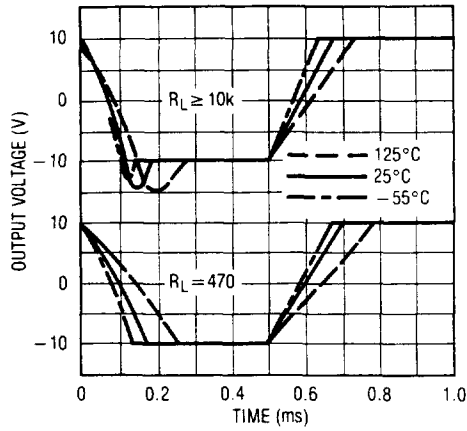

Noise Rejection

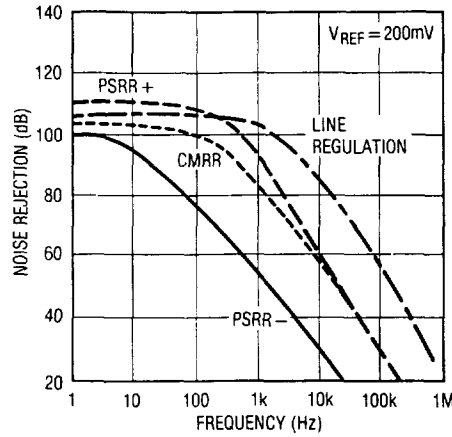

Rejection Slew Limiting

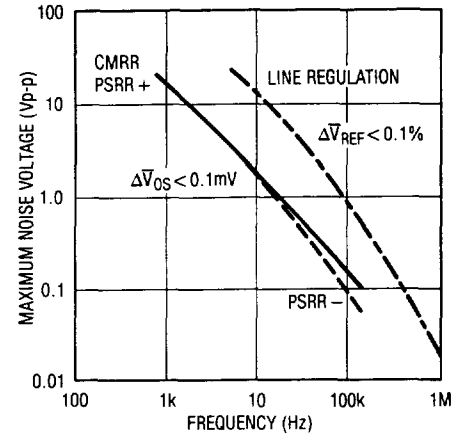

Shunt Gain

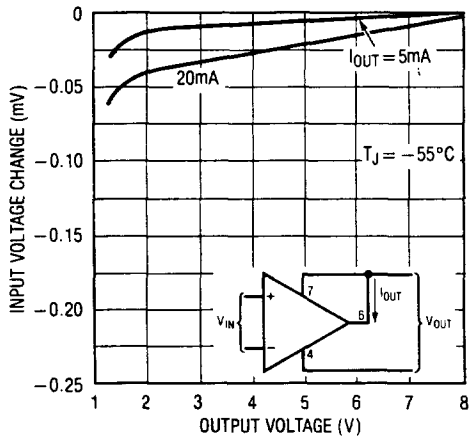

Shunt Gain

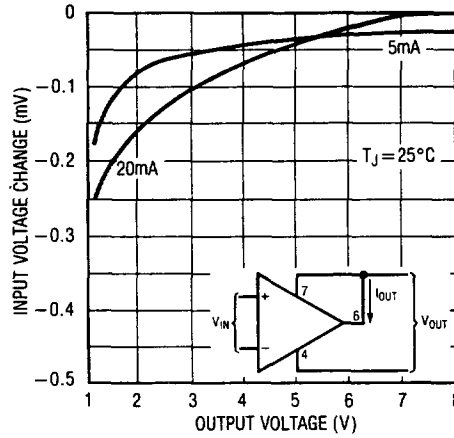

Shunt Gain

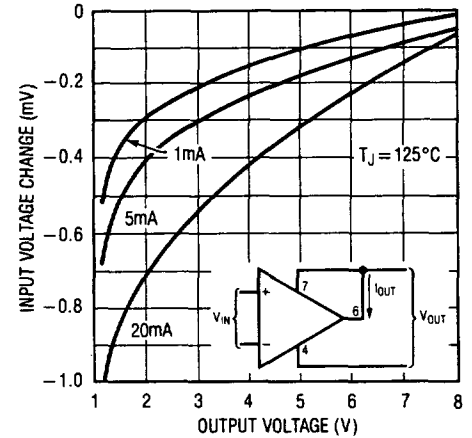

Thermal Gradient Feedback

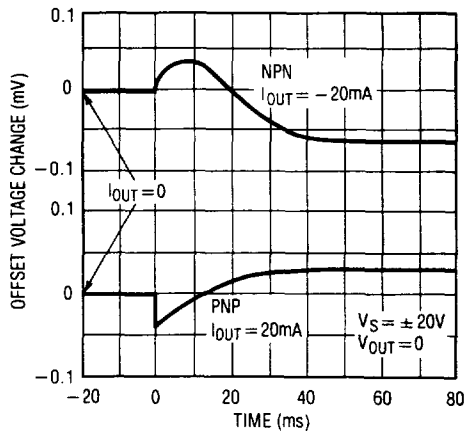

Change in Reference Op Amp Loading

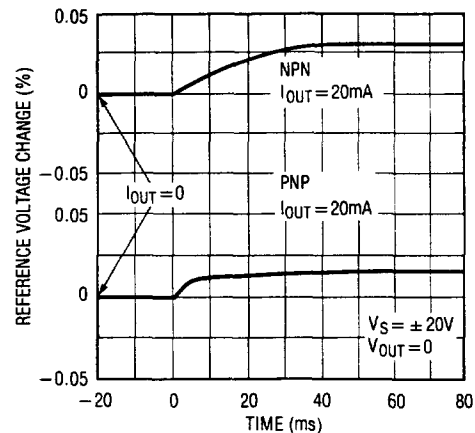

TYPICAL PERFORMANCE CHARACTERISTICS (Reference)

Supply Current

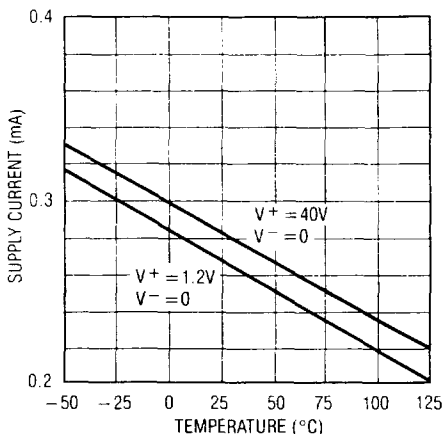

Load Regulation

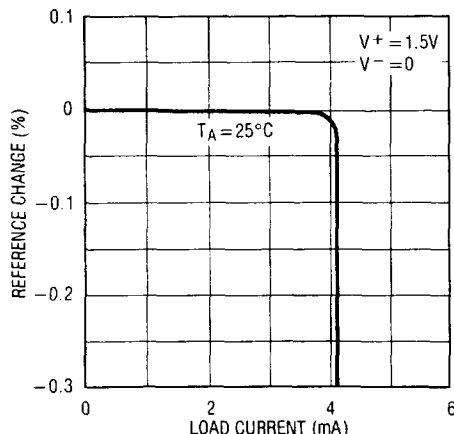

Reference Noise Voltage

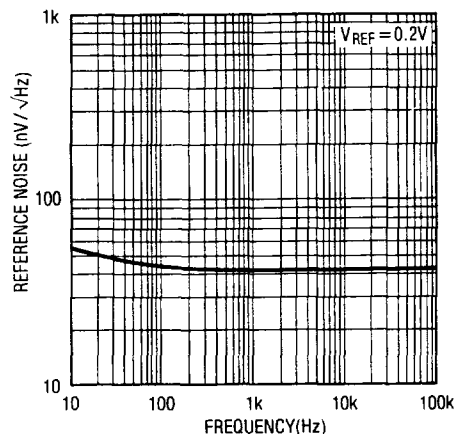

2

Minimum Supply Voltage

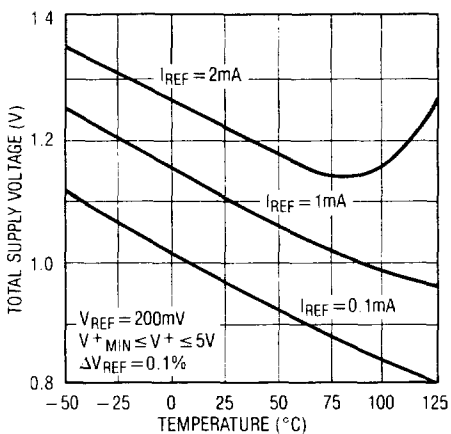

Output Saturation

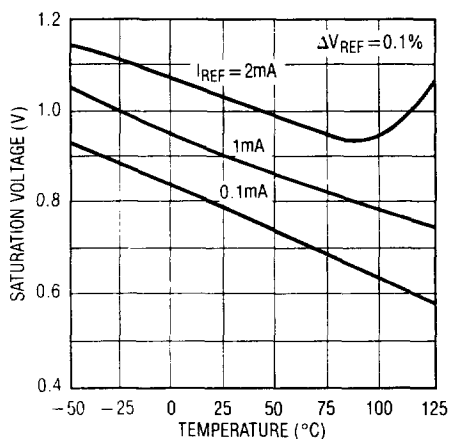

Typical Stability Range

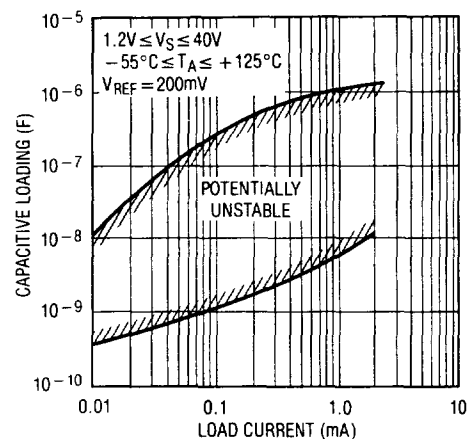

BLOCK DIAGRAM

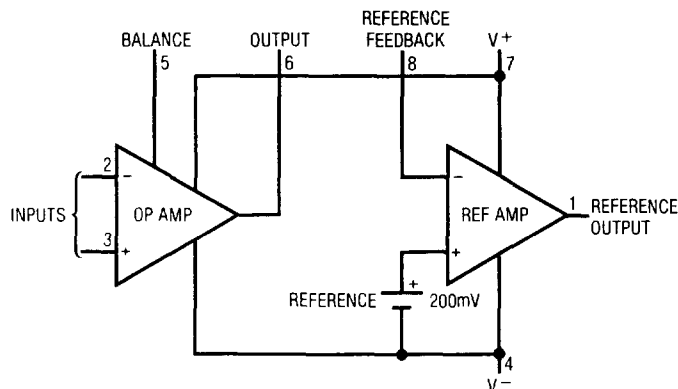

APPLICATION HINTS

With heavy amplifier loading to V^- , resistance drops in the V^- lead can adversely affect reference regulation.

Lead resistance can approach 1Ω . Therefore, the common to the reference circuitry should be connected as close as possible to the package.

TYPICAL APPLICATIONS

Standard Offset Adjustment

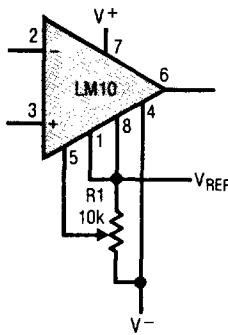

Limited Range Offset Adjustment

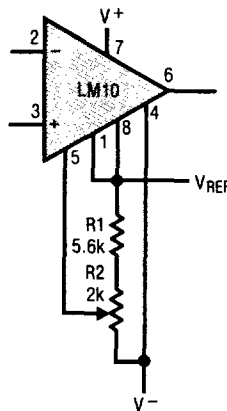

Limited Range Offset Adjustment with Boosted Reference

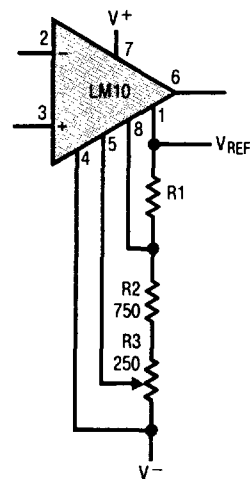

Low Voltage Regulator

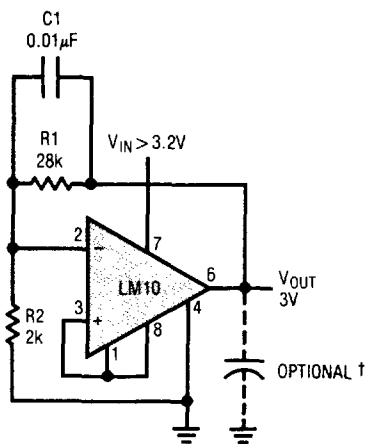

† USE ELECTROLYTIC OUTPUT CAPACITORS

Best Regulation

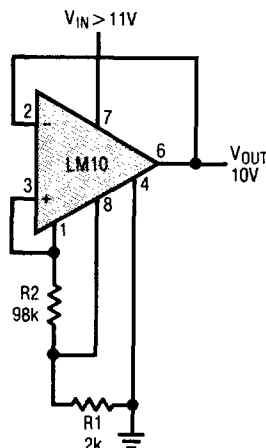

0V to 5V Regulator

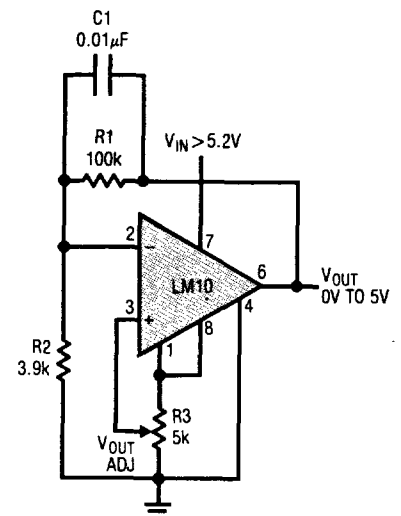

TYPICAL APPLICATIONS

Two-Terminal Current Regulator

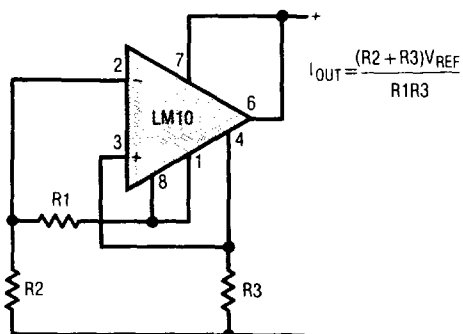

Shunt Regulator

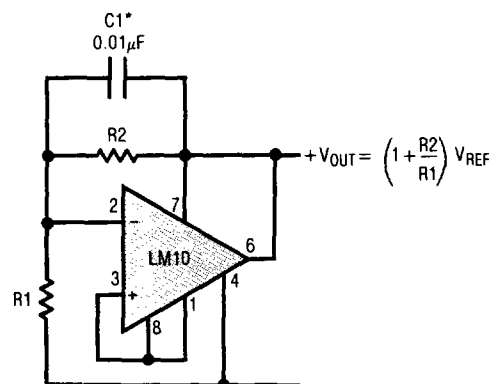

*REQUIRED FOR CAPACITIVE LOADING

2

Negative Regulator

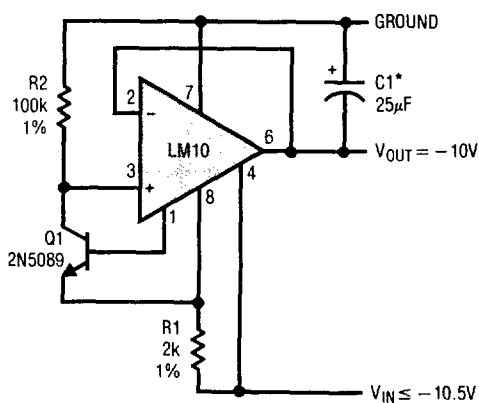

*ELECTROLYTIC

Floating Regulator

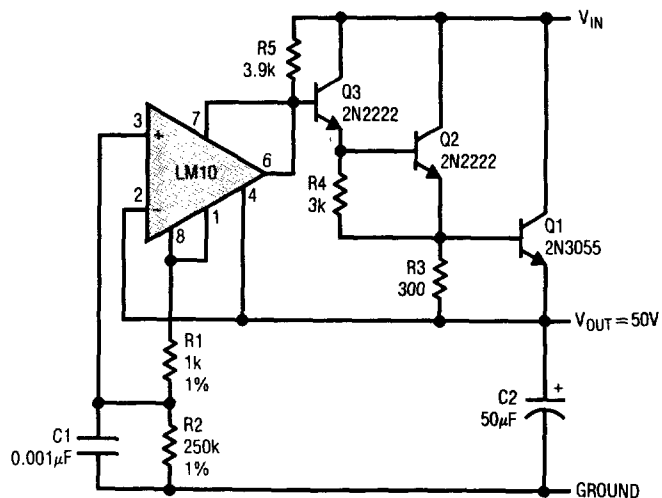

TYPICAL APPLICATIONS

High Voltage Regulator

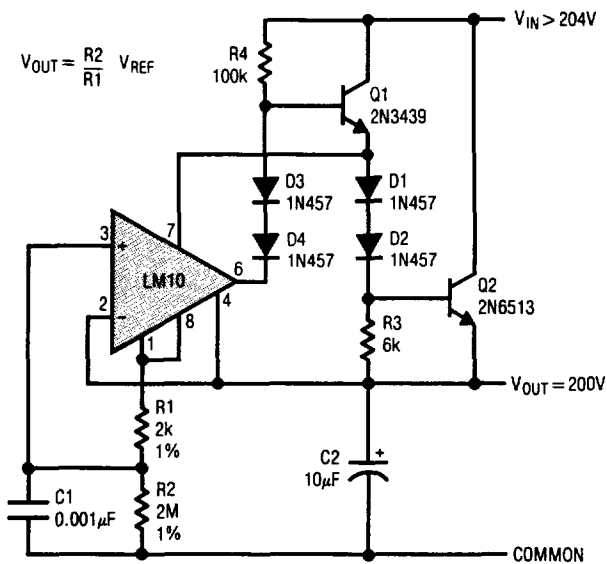

6V Battery-Level Indicator

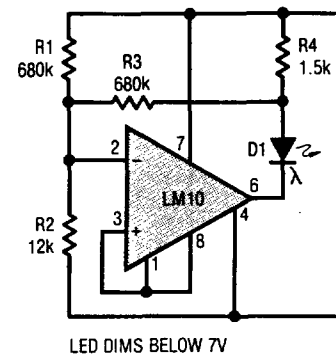

Light Level Sensor

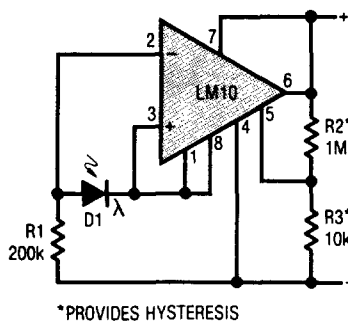

Transducer Amplifier

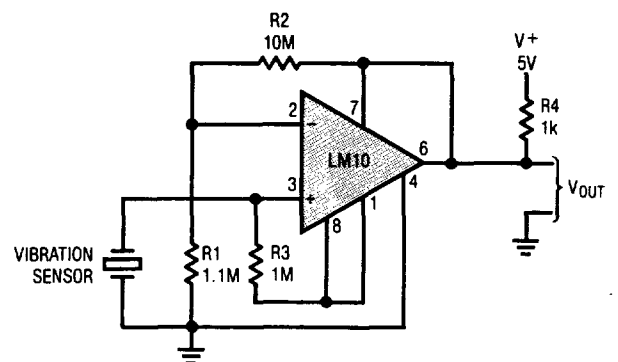

TYPICAL APPLICATIONS

Thermocouple Transmitter

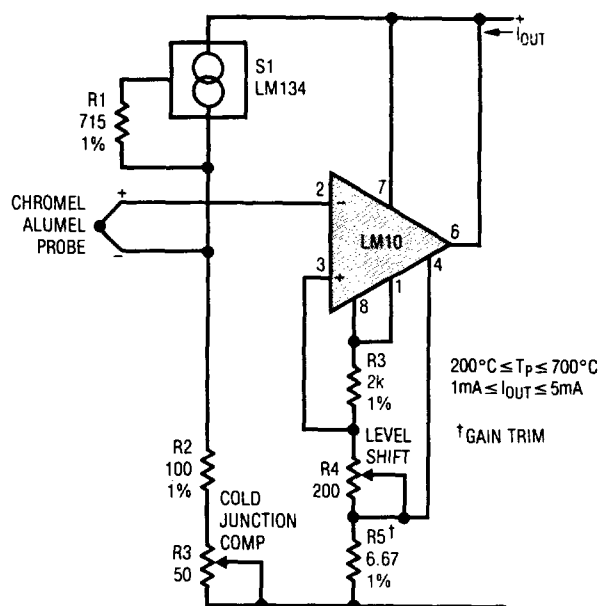

Flame Detector

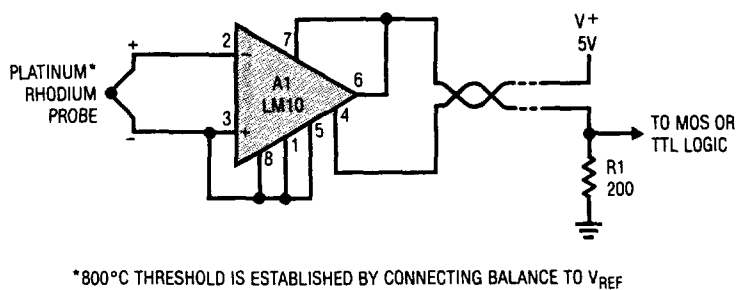

2

Meter Amplifier

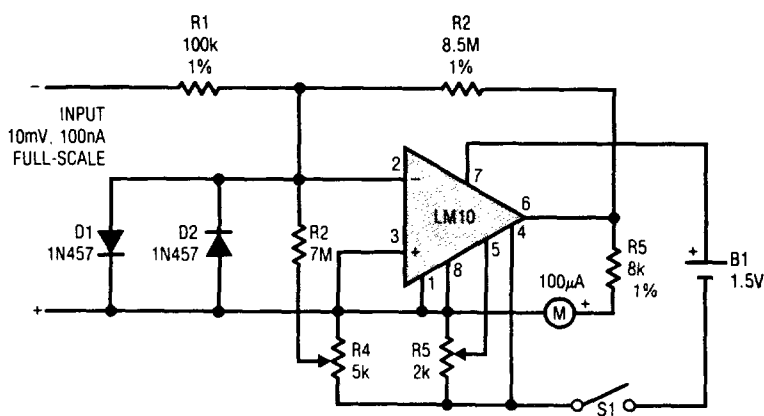

Thermometer

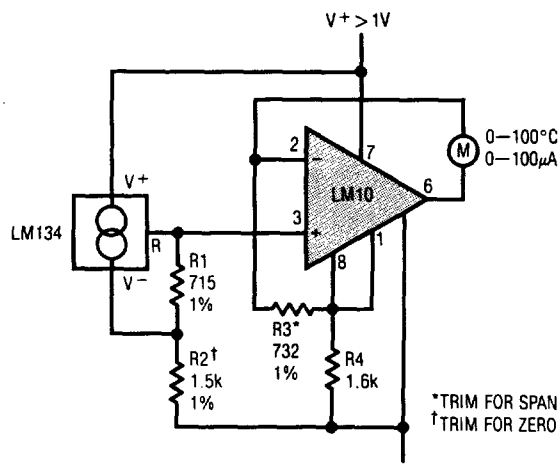

TYPICAL APPLICATIONS

Microphone Amplifier
 $A_v \approx 1k$

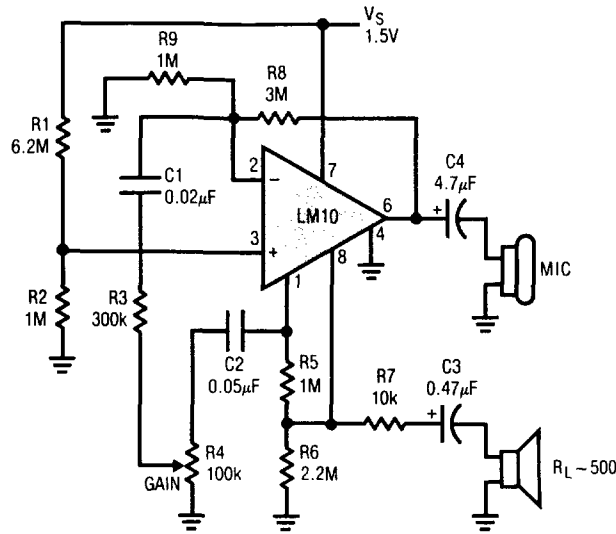

Isolated Voltage Sensor
 for Switching Regulators

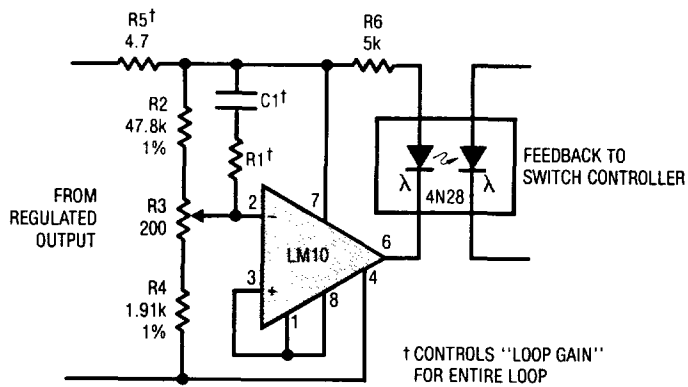

OP AMP SCHEMATIC DIAGRAM

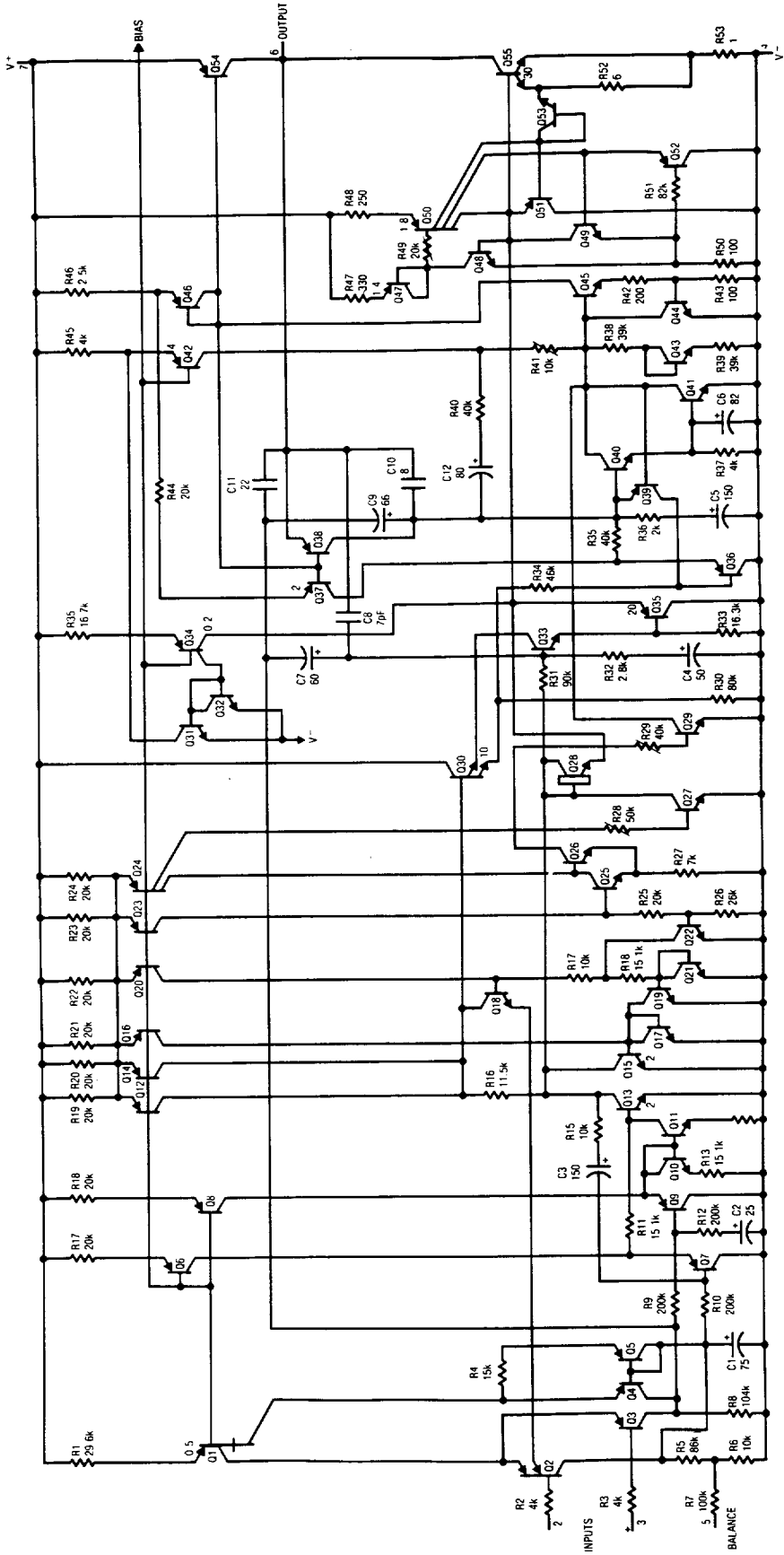

Looking for pricing, stock, or lifecycle information?

Click below to explore more details on WIN SOURCE:

 [View LM10CLN8 on WIN SOURCE](#)

 [Linear Technology](#) Information

Optimize Your Supply Chain with WIN SOURCE Solutions

-  Global Sourcing Solution
-  Obsolete Management
-  Cost Control Management
-  Shortage Management
-  Alternative Solution
-  Excess Inventory Management