



THE DATASHEET OF LM1036N



LM1036 Dual DC Operated Tone/Volume/Balance Circuit

Check for Samples: [LM1036](#)

FEATURES

- **Wide Supply Voltage Range, 9V to 16V**
- **Large Volume Control Range, 75 dB Typical**
- **Tone Control, ± 15 dB Typical**
- **Channel Separation, 75 dB Typical**
- **Low Distortion, 0.06% Typical for An Input Level of 0.3 Vrms**
- **High Signal to Noise, 80 dB Typical for an Input Level of 0.3 Vrms**
- **Few External Components Required**

DESCRIPTION

The LM1036 is a DC controlled tone (bass/treble), volume and balance circuit for stereo applications in car radio, TV and audio systems. An additional control input allows loudness compensation to be simply effected.

Four control inputs provide control of the bass, treble, balance and volume functions through application of DC voltages from a remote control system or, alternatively, from four potentiometers which may be biased from a zener regulated supply provided on the circuit.

Each tone response is defined by a single capacitor chosen to give the desired characteristic.

Block and Connection Diagram

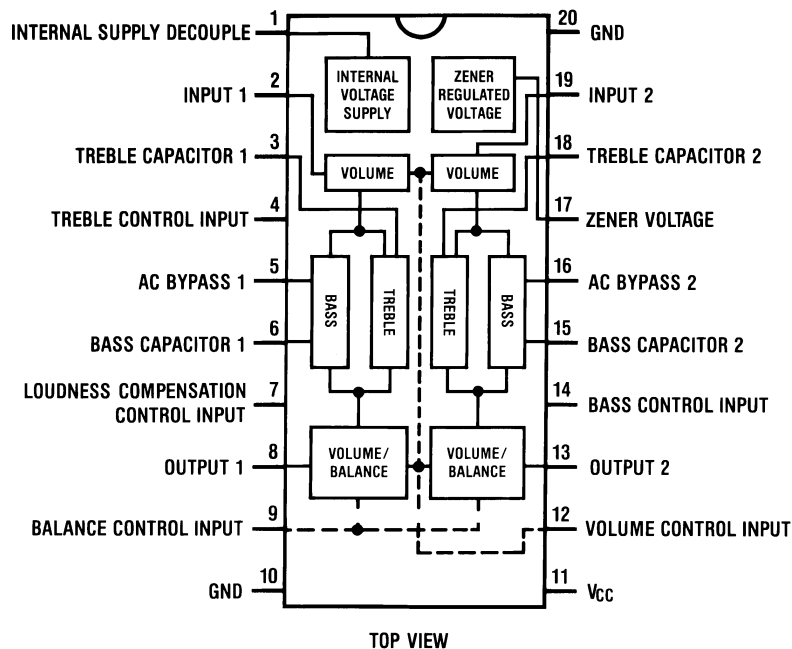

**Figure 1. PDIP and SOIC Packages
See Package Numbers NFH0020A or DW0020B**



Please be aware that an important notice concerning availability, standard warranty, and use in critical applications of Texas Instruments semiconductor products and disclaimers thereto appears at the end of this data sheet.

All trademarks are the property of their respective owners.



These devices have limited built-in ESD protection. The leads should be shorted together or the device placed in conductive foam during storage or handling to prevent electrostatic damage to the MOS gates.

Absolute Maximum Ratings⁽¹⁾⁽²⁾

Supply Voltage	16V
Control Pin Voltage (Pins 4, 7, 9, 12, 14)	V_{CC}
Operating Temperature Range	0°C to +70°C
Storage Temperature Range	-65°C to +150°C
Power Dissipation	1W
Lead Temp. (Soldering, 10 seconds)	260°C

- (1) Absolute Maximum Ratings indicate limits beyond which damage to the device may occur. Operating Ratings indicate conditions for which the device is functional, but do not ensure specific performance limits.
- (2) If Military/Aerospace specified devices are required, please contact the Texas Instruments Sales Office/ Distributors for availability and specifications.

Electrical Characteristics⁽¹⁾

$V_{CC}=12V$, $T_A=25^\circ C$ (unless otherwise stated)

Parameter	Conditions	Min	Typ	Max	Units
Supply Voltage Range	Pin 11	9		16	V
Supply Current			35	45	mA
Zener Regulated Output Voltage	Pin 17		5.4		V
Zener Regulated Output Current				5	mA
Maximum Output Voltage	Pins 8, 13; $f=1$ kHz $V_{CC}=9V$, Maximum Gain $V_{CC}=12V$	0.8	0.8 1.0		Vrms Vrms
Maximum Input Voltage	Pins 2, 19; $f=1$ kHz, $V_{CC} 2V$ Gain=-10 dB	1.3	1.6		Vrms
Input Resistance	Pins 2, 19; $f=1$ kHz	20	30		k Ω
Output Resistance	Pins 8, 13; $f=1$ kHz		20		Ω
Maximum Gain	$V(\text{Pin } 12)=V(\text{Pin } 17)$; $f=1$ kHz	-2	0	2	dB
Volume Control Range	$f=1$ kHz	70	75		dB
Gain Tracking	$f=1$ kHz				
Channel 1–Channel 2	0 dB through -40 dB		1	3	dB
	-40 dB through -60 dB		2		dB
Balance Control Range	Pins 8, 13; $f=1$ kHz		1		dB
			-26	-20	dB
Bass Control Range ⁽²⁾	$f=40$ Hz, $C_b=0.39$ μF $V(\text{Pin } 14)=V(\text{Pin } 17)$ $V(\text{Pin } 14)=0V$	12 -12	15 -15	18 -18	dB dB
Treble Control Range ⁽²⁾	$f=16$ kHz, $C_t=0.01$ μF $V(\text{Pin } 4)=V(\text{Pin } 17)$ $V(\text{Pin } 4)=0V$	12 -12	15 -15	18 -18	dB dB
Total Harmonic Distortion	$f=1$ kHz, $V_{IN}=0.3$ Vrms Gain=0 dB Gain=-30 dB		0.06 0.03	0.3	% %
Channel Separation	$f=1$ kHz, Maximum Gain	60	75		dB

(1) The maximum permissible input level is dependent on tone and volume settings. See [Application Notes](#).

(2) The tone control range is defined by capacitors C_b and C_t . See [Application Notes](#).

Electrical Characteristics⁽¹⁾ (continued)
 $V_{CC}=12V$, $T_A=25^{\circ}C$ (unless otherwise stated)

Parameter	Conditions	Min	Typ	Max	Units
Signal/Noise Ratio	Unweighted 100 Hz–20 kHz		80		dB
	Maximum Gain, 0 dB=0.3 Vrms				
	CCIR/ARM ⁽³⁾				
	Gain=0 dB, $V_{IN}=0.3$ Vrms	75	79		dB
	Gain=-20 dB, $V_{IN}=1.0$ Vrms		72		dB
Output Noise Voltage at Minimum Gain	CCIR/ARM ⁽³⁾		10	16	μV
Supply Ripple Rejection	200 mVrms, 1 kHz Ripple	35	50		dB
Control Input Currents	Pins 4, 7, 9, 12, 14 ($V=0V$)		-0.6	-2.5	μA
Frequency Response	-1 dB (Flat Response 20 Hz–16 kHz)		250		kHz

(3) Gaussian noise, measured over a period of 50 ms per channel, with a CCIR filter referenced to 2 kHz and an average-responding meter.

Typical Performance Characteristics

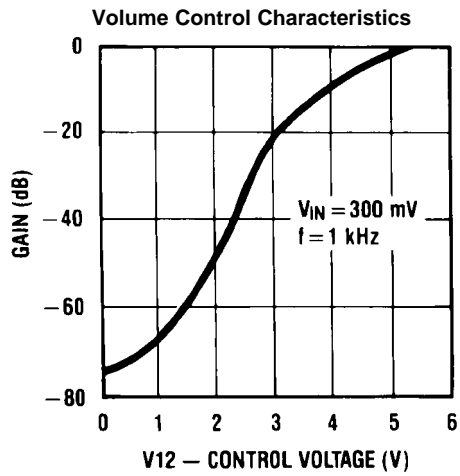

Figure 2.

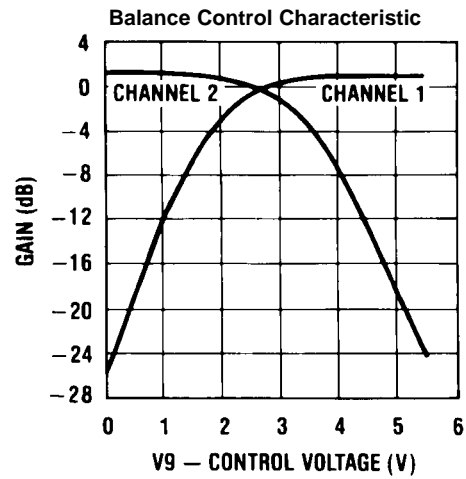

Figure 3.

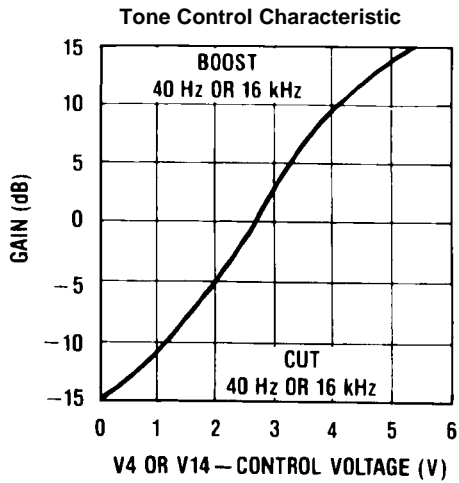

Figure 4.

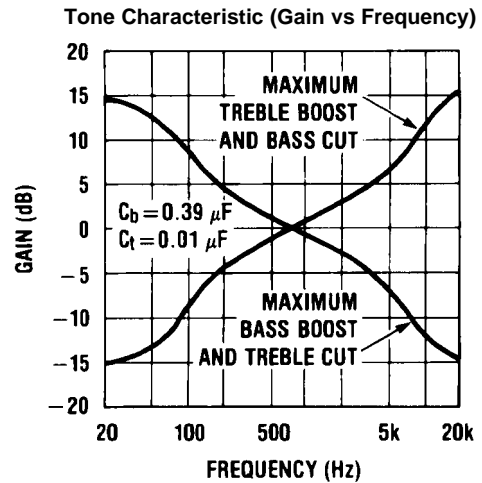

Figure 5.

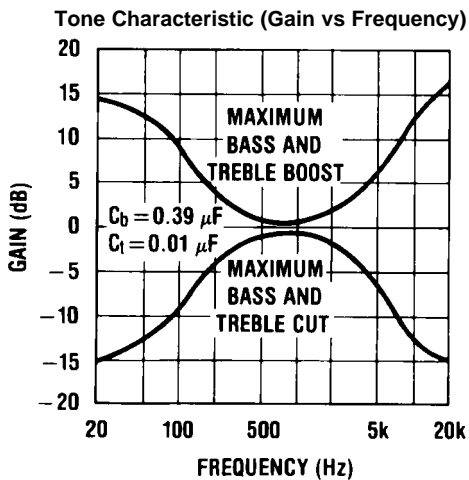

Figure 6.

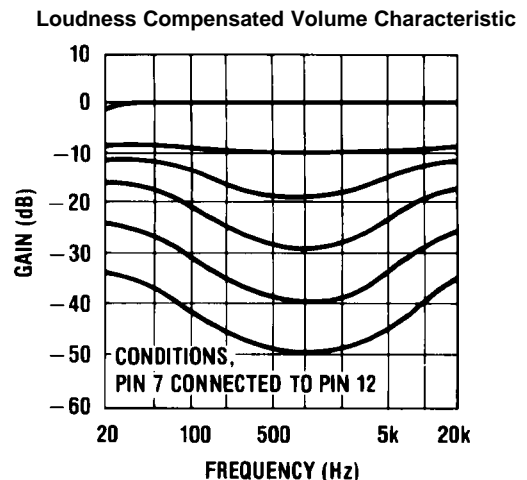

Figure 7.

Typical Performance Characteristics (continued)

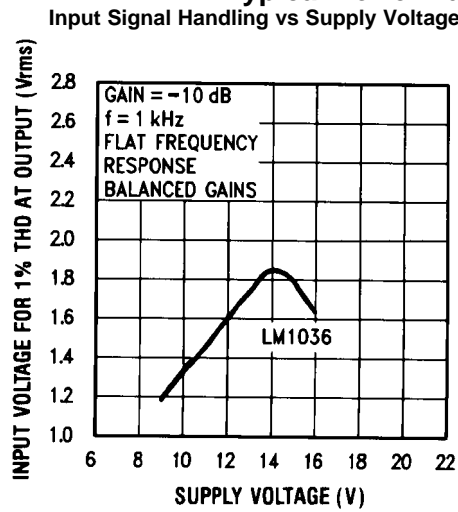

Figure 8.

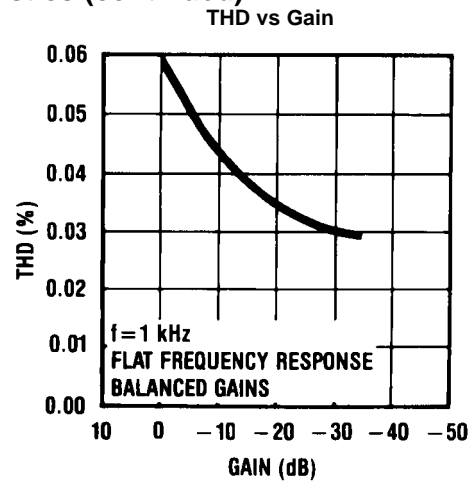

Figure 9.

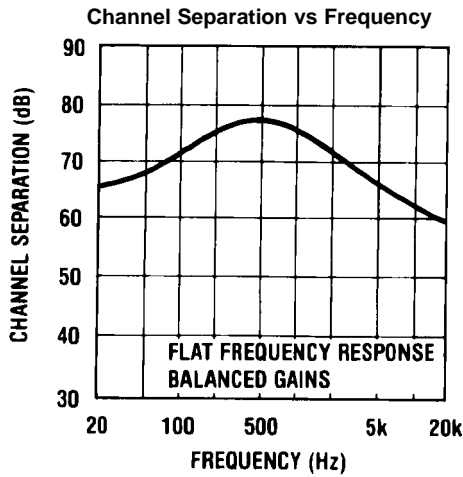

Figure 10.

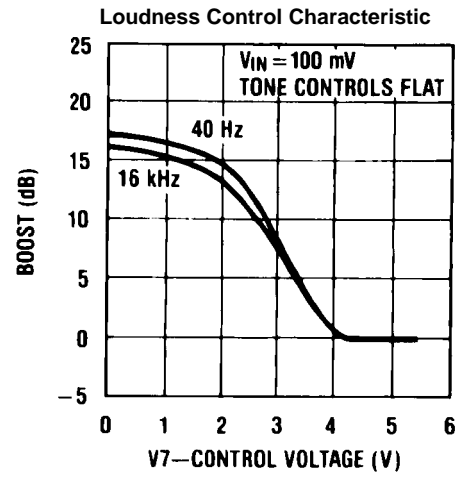

Figure 11.

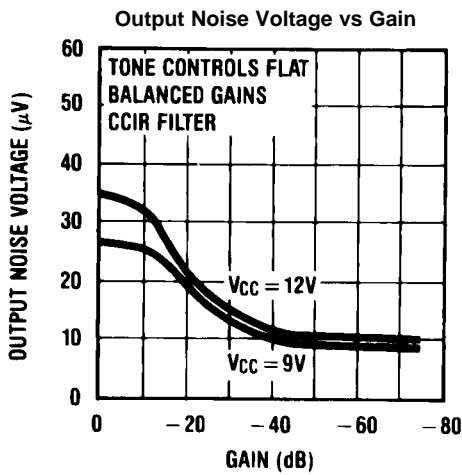

Figure 12.

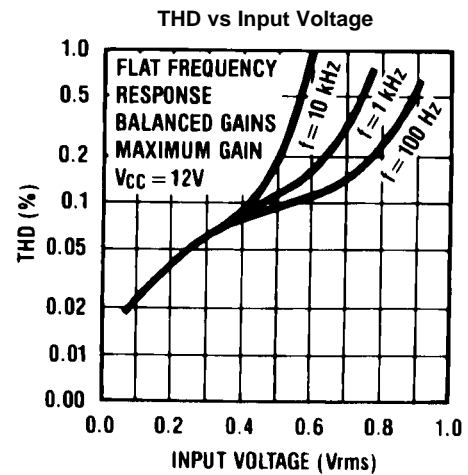

Figure 13.

Application Notes

TONE RESPONSE

The maximum boost and cut can be optimized for individual applications by selection of the appropriate values of C_t (treble) and C_b (bass).

The tone responses are defined by the relationships:

$$\text{Bass Response} = \frac{1 + \frac{0.00065(1 - a_b)}{j\omega C_b}}{1 + \frac{0.00065a_b}{j\omega C_b}}$$

$$\text{Treble Response} = \frac{1 + j\omega 5500(1 - a_t)C_t}{1 + j\omega 5500a_t C_t}$$

where

- $a_b = a_t = 0$ for maximum bass and treble boost respectively
- $a_b = a_t = 1$ for maximum cut (1)

For the values of C_b and C_t of 0.39 μF and 0.01 μF as shown in the [Application Circuit](#), 15 dB of boost or cut is obtained at 40 Hz and 16 kHz.

ZENER VOLTAGE

A zener voltage (pin 17=5.4V) is provided which may be used to bias the control potentiometers. Setting a DC level of one half of the zener voltage on the control inputs, pins 4, 9, and 14, results in the balanced gain and flat response condition. Typical spread on the zener voltage is ± 100 mV and this must be taken into account if control signals are used which are not referenced to the zener voltage. If this is the case, then they will need to be derived with similar accuracy.

LOUDNESS COMPENSATION

A simple loudness compensation may be effected by applying a DC control voltage to pin 7. This operates on the tone control stages to produce an additional boost limited by the maximum boost defined by C_b and C_t . There is no loudness compensation when pin 7 is connected to pin 17. Pin 7 can be connected to pin 12 to give the loudness compensated volume characteristic as illustrated without the addition of further external components. (Tone settings are for flat response, C_b and C_t as given in Application Circuit.) Modification to the loudness characteristic is possible by changing the capacitors C_b and C_t for a different basic response or, by a resistor network between pins 7 and 12 for a different threshold and slope.

SIGNAL HANDLING

The volume control function of the LM1036 is carried out in two stages, controlled by the DC voltage on pin 12, to improve signal handling capability and provide a reduction of output noise level at reduced gain. The first stage is before the tone control processing and provides an initial 15 dB of gain reduction, so ensuring that the tone sections are not overdriven by large input levels when operating with a low volume setting. Any combination of tone and volume settings may be used provided the output level does not exceed 1 V_{rms}, $V_{CC}=12\text{V}$ (0.8 V_{rms}, $V_{CC}=9\text{V}$). At reduced gain (< -6 dB) the input stage will overload if the input level exceeds 1.6 V_{rms}, $V_{CC}=12\text{V}$ (1.1 V_{rms}, $V_{CC}=9\text{V}$). As there is volume control on the input stages, the inputs may be operated with a lower overload margin than would otherwise be acceptable, allowing a possible improvement in signal to noise ratio.

Application Circuit

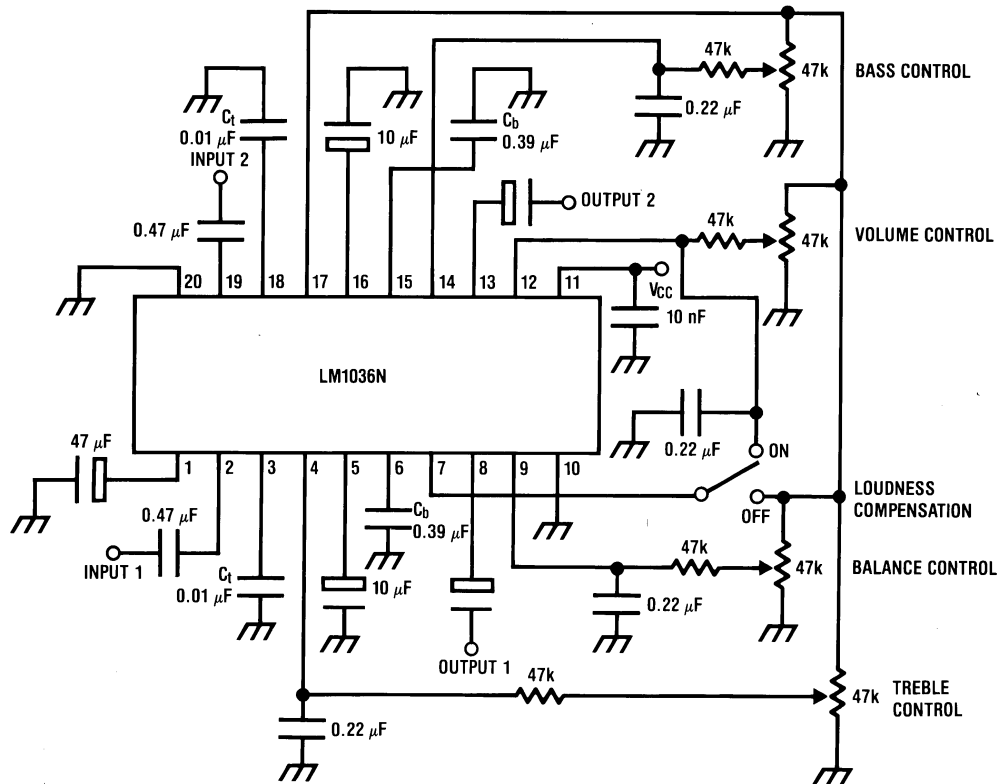

APPLICATIONS INFORMATION

OBTAINING MODIFIED RESPONSE CURVES

The LM1036 is a dual DC controlled bass, treble, balance and volume integrated circuit ideal for stereo audio systems.

In the various applications where the LM1036 can be used, there may be requirements for responses different to those of the standard application circuit given in the data sheet. This application section details some of the simple variations possible on the standard responses, to assist the choice of optimum characteristics for particular applications.

TONE CONTROLS

Summarizing the relationship given in the data sheet, basically for an increase in the treble control range C_t must be increased, and for increased bass range C_b must be reduced.

Figure 14 shows the typical tone response obtained in the standard application circuit. ($C_t=0.01 \mu\text{F}$, $C_b=0.39 \mu\text{F}$). Response curves are given for various amounts of boost and cut.

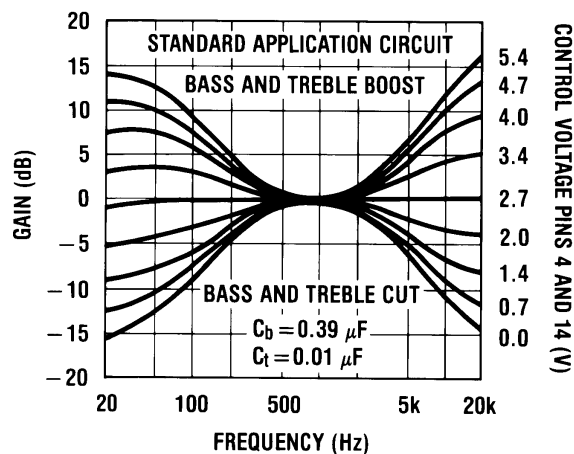

Figure 14. Tone Characteristic (Gain vs Frequency)

Figure 15 and Figure 16 show the effect of changing the response defining capacitors C_t and C_b to $2C_t$, $C_b/2$ and $4C_t$, $C_b/4$ respectively, giving increased tone control ranges. The values of the bypass capacitors may become significant and affect the lower frequencies in the bass response curves.

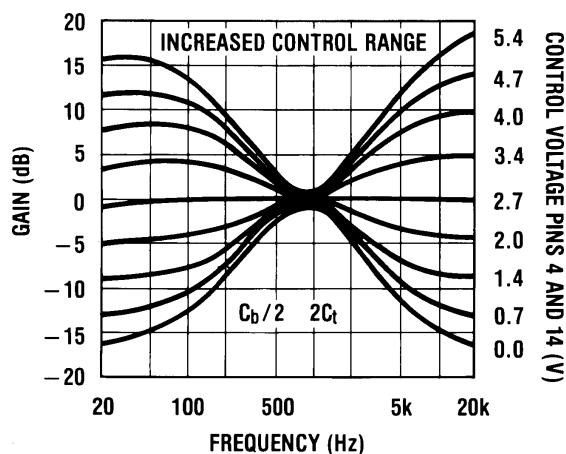

Figure 15. Tone Characteristic (Gain vs Frequency)

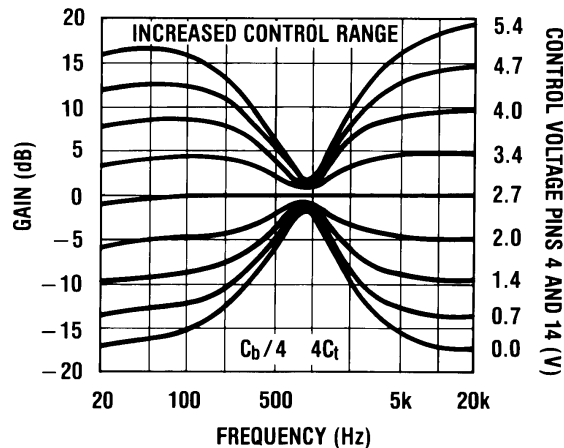

Figure 16. Tone Characteristic (Gain vs Frequency)

Figure 17 shows the effect of changing C_t and C_b in the opposite direction to $C_t/2$, $2C_b$ respectively giving reduced control ranges. The various results corresponding to the different C_t and C_b values may be mixed if it is required to give a particular emphasis to, for example, the bass control. The particular case with $C_b/2$, C_t is illustrated in Figure 18.

Restriction of Tone Control Action at High or Low Frequencies

It may be desired in some applications to level off the tone responses above or below certain frequencies for example to reduce high frequency noise.

This may be achieved for the treble response by including a resistor in series with C_t . The treble boost and cut will be 3 dB less than the standard circuit when $R=X_{C_t}$.

A similar effect may be obtained for the bass response by reducing the value of the AC bypass capacitors on pins 5 (channel 1) and 16 (channel 2). The internal resistance at these pins is 1.3 k Ω and the bass boost/cut will be approximately 3 dB less with X_C at this value. An example of such modified response curves is shown in Figure 19. The input coupling capacitors may also modify the low frequency response.

It will be seen from Figure 15 and Figure 16 that modifying C_t and C_b for greater control range also has the effect of flattening the tone control extremes and this may be utilized, with or without additional modification as outlined above, for the most suitable tone control range and response shape.

Other Advantages of DC Controls

The DC controls make the addition of other features easy to arrange. For example, the negative-going peaks of the output amplifiers may be detected below a certain level, and used to bias back the bass control from a high boost condition, to prevent overloading the speaker with low frequency components.

LOUDNESS CONTROL

The loudness control is achieved through control of the tone sections by the voltage applied to pin 7; therefore, the tone and loudness functions are not independent. There is normally 1 dB more bass than treble boost (40 Hz–16 kHz) with loudness control in the standard circuit. If a greater difference is desired, it is necessary to introduce an offset by means of C_t or C_b or by changing the nominal control voltage ranges.

Figure 20 shows the typical loudness curves obtained in the standard application circuit at various volume levels ($C_b=0.39 \mu\text{F}$).

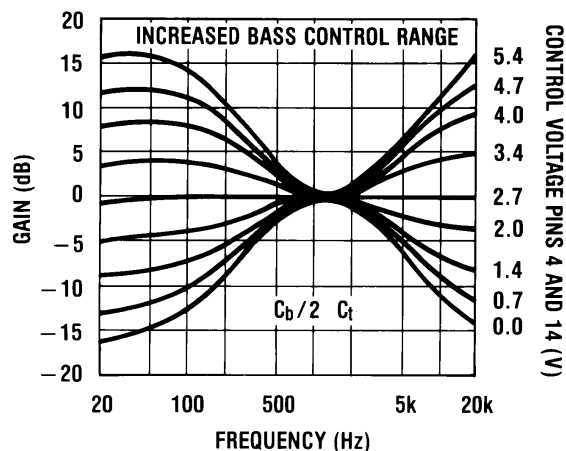
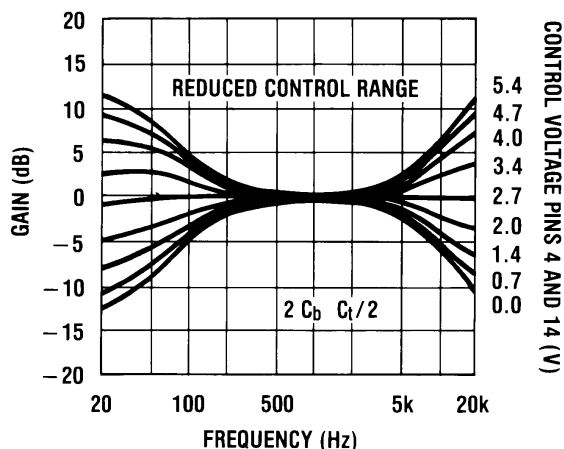

Figure 17. Tone Characteristic (Gain vs Frequency) Figure 18. Tone Characteristic (Gain vs Frequency)

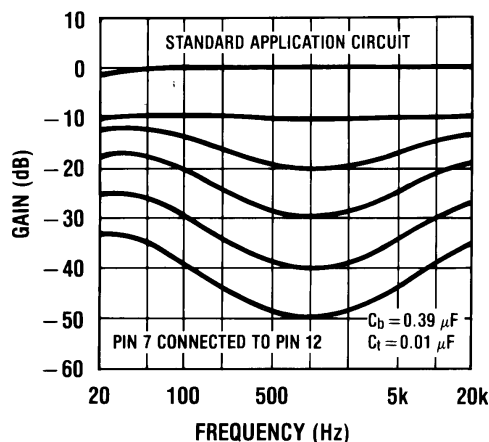
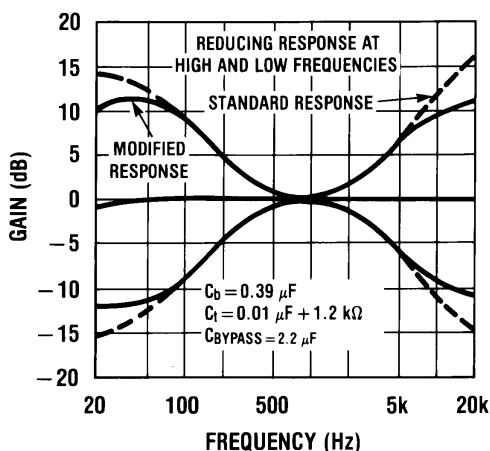

Figure 19. Tone Characteristic (Gain vs Frequency)

Figure 20. Loudness Compensated Volume Characteristic

Figure 21 and Figure 22 illustrate the loudness characteristics obtained with C_b changed to $C_b/2$ and $C_b/4$ respectively, C_t being kept at the nominal $0.01 \mu\text{F}$. These values naturally modify the bass tone response as in Figure 15 and Figure 16.

With pins 7 (loudness) and 12 (volume) directly connected, loudness control starts at typically -8 dB volume, with most of the control action complete by -30 dB .

Figure 23 and Figure 24 show the effect of resistively offsetting the voltage applied to pin 7 towards the control reference voltage (pin 17). Because the control inputs are high impedance, this is easily done and high value resistors may be used for minimal additional loading. It is possible to reduce the rate of onset of control to extend the active range to -50 dB volume control and below.

The control on pin 7 may also be divided down towards ground bringing the control action on earlier. This is illustrated in Figure 25. With a suitable level shifting network between pins 12 and 7, the onset of loudness control and its rate of change may be readily modified.

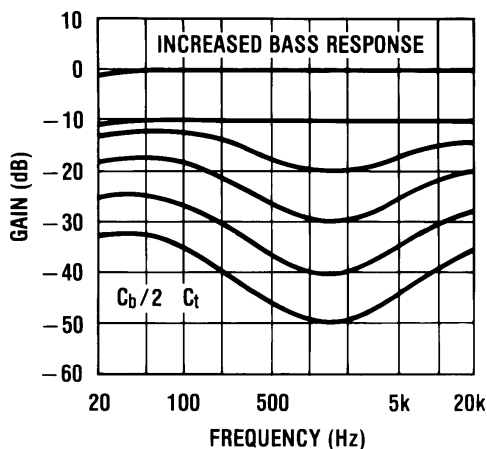

Figure 21. Loudness Compensated Volume Characteristic

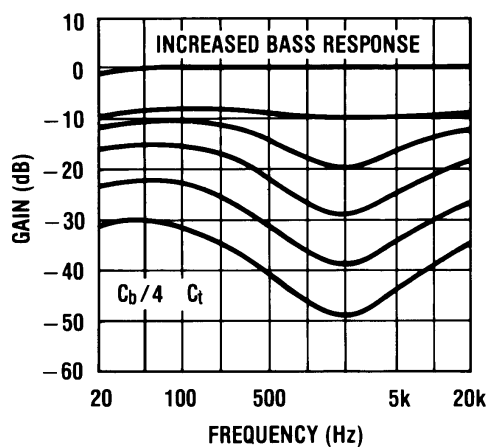

Figure 22. Loudness Compensated Volume Characteristic

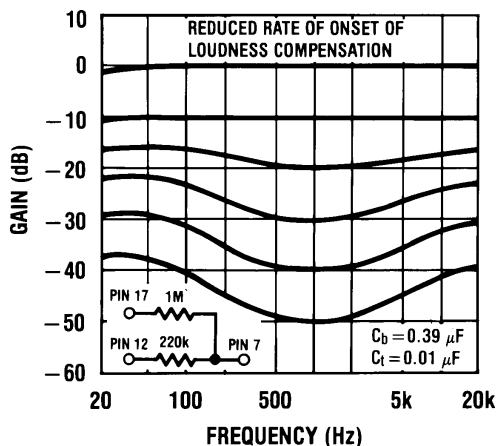

Figure 23. Loudness Compensated Volume Characteristic

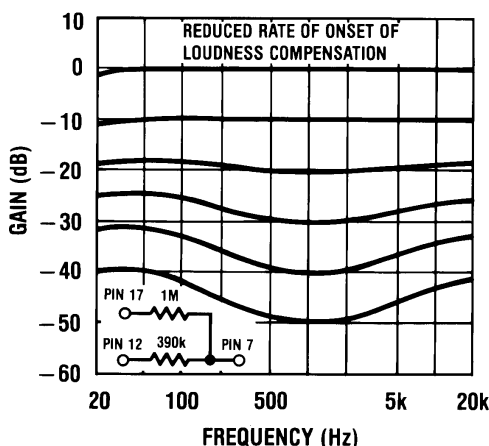

Figure 24. Loudness Compensated Volume Characteristic

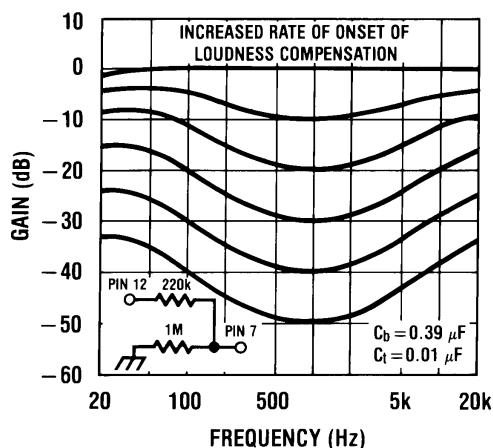

Figure 25. Loudness Compensated Volume Characteristic

When adjusted for maximum boost in the usual application circuit, the LM1036 cannot give additional boost from the loudness control with reducing gain. If it is required, some additional boost can be obtained by restricting the tone control range and modifying C_t , C_b , to compensate. A circuit illustrating this for the case of bass boost is shown in Figure 26. The resulting responses are given in Figure 27 showing the continuing loudness control action possible with bass boost previously applied.

USE OF THE LM1036 ABOVE AUDIO FREQUENCIES

The LM1036 has a basic response typically 1 dB down at 250 kHz (tone controls flat) and therefore by scaling C_b and C_t , it is possible to arrange for operation over a wide frequency range for possible use in wide band equalization applications. As an example Figure 28 shows the responses obtained centered on 10 kHz with $C_b=0.039 \mu\text{F}$ and $C_t=0.001 \mu\text{F}$.

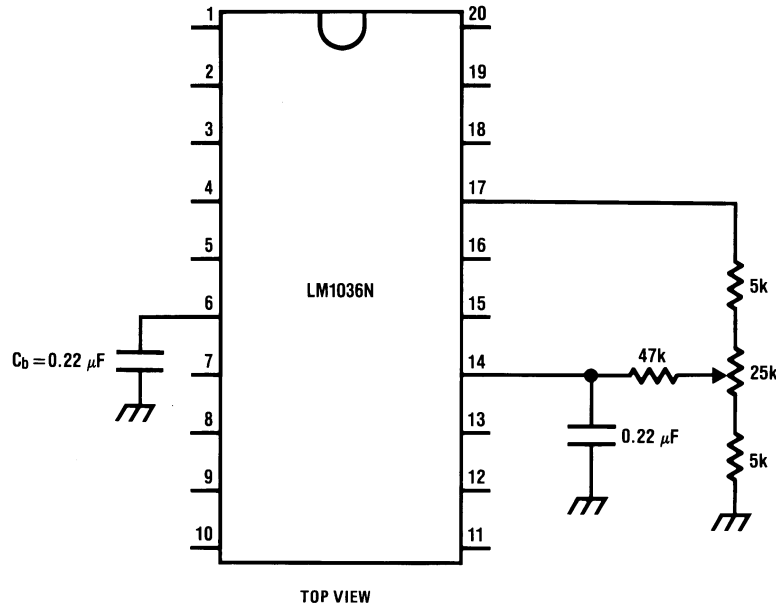

Figure 26. Modified Application Circuit for Additional Bass Boost with Loudness Control

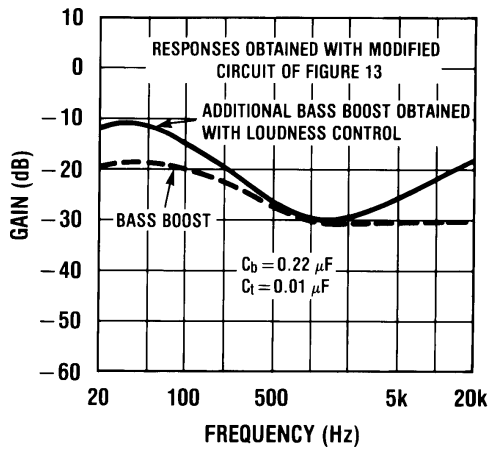

Figure 27. Loudness Compensated Volume Characteristic

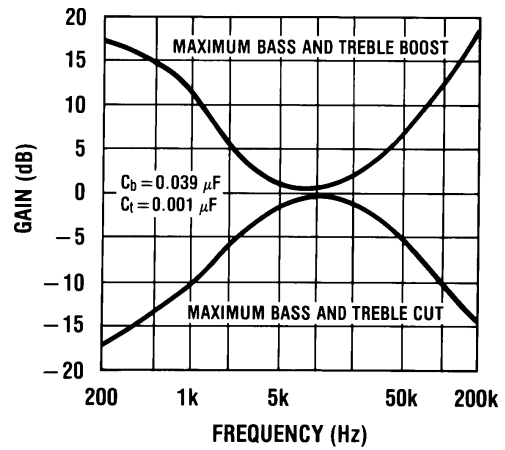
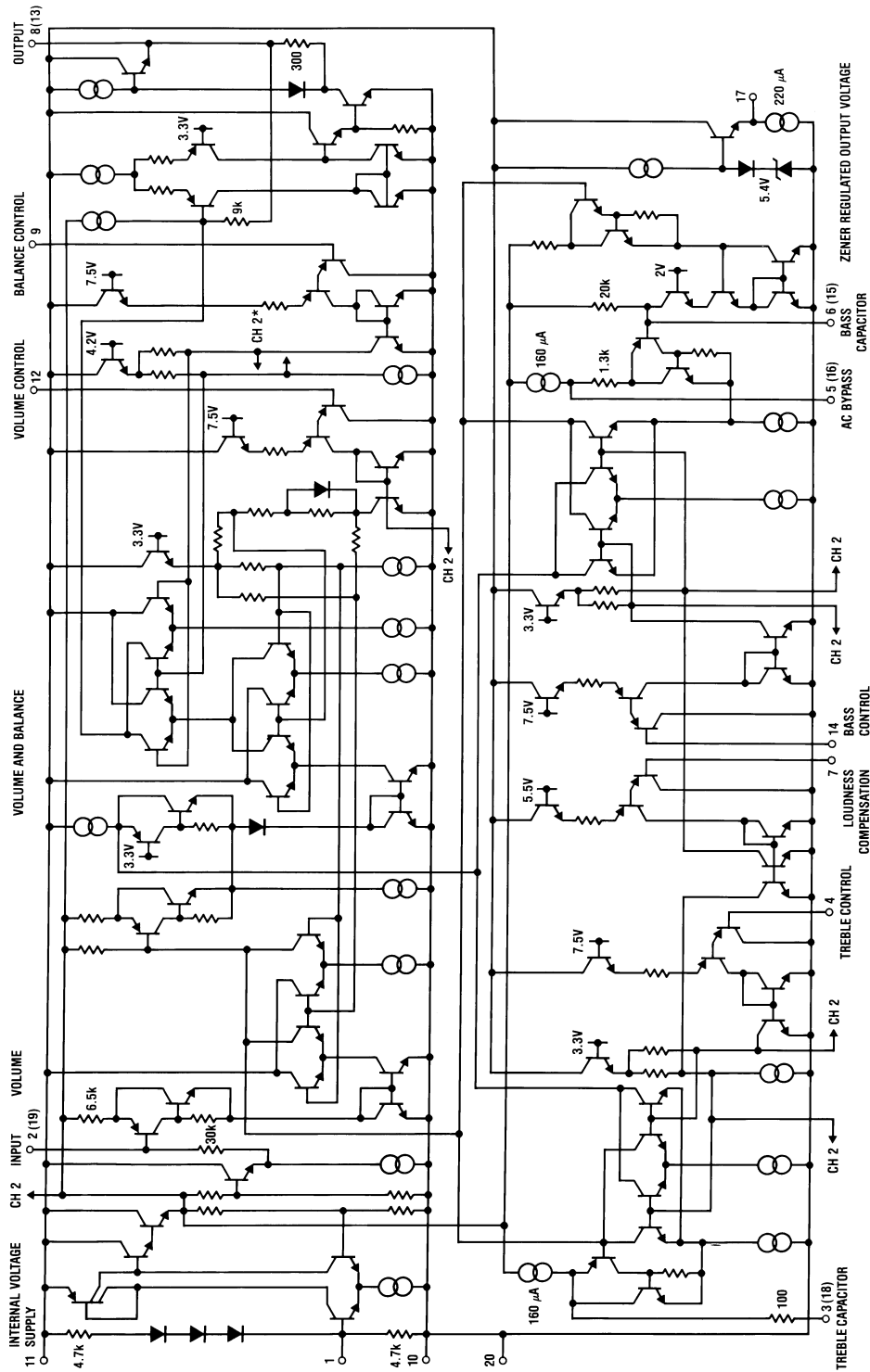

Figure 28. Tone Characteristic (Gain vs Frequency)

Simplified Schematic Diagram

(One Channel)



*Connections reversed

REVISION HISTORY

Changes from Revision B (April 2013) to Revision C	Page
• Changed layout of National Data Sheet to TI format	13

PACKAGING INFORMATION

Orderable Device	Status (1)	Package Type	Package Drawing	Pins	Package Qty	Eco Plan (2)	Lead/Ball Finish (6)	MSL Peak Temp (3)	Op Temp (°C)	Device Marking (4/5)	Samples
LM1036M/NOPB	OBSOLETE	SOIC	DW	20		TBD	Call TI	Call TI	0 to 70	LM1036M	
LM1036MX/NOPB	OBSOLETE	SOIC	DW	20		TBD	Call TI	Call TI	0 to 70	LM1036M	
LM1036N/NOPB	OBSOLETE	PDIP	NFH	20		TBD	Call TI	Call TI	0 to 70	LM1036N	

(1) The marketing status values are defined as follows:

ACTIVE: Product device recommended for new designs.

LIFEBUY: TI has announced that the device will be discontinued, and a lifetime-buy period is in effect.

NRND: Not recommended for new designs. Device is in production to support existing customers, but TI does not recommend using this part in a new design.

PREVIEW: Device has been announced but is not in production. Samples may or may not be available.

OBSOLETE: TI has discontinued the production of the device.

(2) Eco Plan - The planned eco-friendly classification: Pb-Free (RoHS), Pb-Free (RoHS Exempt), or Green (RoHS & no Sb/Br) - please check <http://www.ti.com/productcontent> for the latest availability information and additional product content details.

TBD: The Pb-Free/Green conversion plan has not been defined.

Pb-Free (RoHS): TI's terms "Lead-Free" or "Pb-Free" mean semiconductor products that are compatible with the current RoHS requirements for all 6 substances, including the requirement that lead not exceed 0.1% by weight in homogeneous materials. Where designed to be soldered at high temperatures, TI Pb-Free products are suitable for use in specified lead-free processes.

Pb-Free (RoHS Exempt): This component has a RoHS exemption for either 1) lead-based flip-chip solder bumps used between the die and package, or 2) lead-based die adhesive used between the die and leadframe. The component is otherwise considered Pb-Free (RoHS compatible) as defined above.

Green (RoHS & no Sb/Br): TI defines "Green" to mean Pb-Free (RoHS compatible), and free of Bromine (Br) and Antimony (Sb) based flame retardants (Br or Sb do not exceed 0.1% by weight in homogeneous material)

(3) MSL, Peak Temp. - The Moisture Sensitivity Level rating according to the JEDEC industry standard classifications, and peak solder temperature.

(4) There may be additional marking, which relates to the logo, the lot trace code information, or the environmental category on the device.

(5) Multiple Device Markings will be inside parentheses. Only one Device Marking contained in parentheses and separated by a "~" will appear on a device. If a line is indented then it is a continuation of the previous line and the two combined represent the entire Device Marking for that device.

(6) Lead/Ball Finish - Orderable Devices may have multiple material finish options. Finish options are separated by a vertical ruled line. Lead/Ball Finish values may wrap to two lines if the finish value exceeds the maximum column width.

Important Information and Disclaimer: The information provided on this page represents TI's knowledge and belief as of the date that it is provided. TI bases its knowledge and belief on information provided by third parties, and makes no representation or warranty as to the accuracy of such information. Efforts are underway to better integrate information from third parties. TI has taken and continues to take reasonable steps to provide representative and accurate information but may not have conducted destructive testing or chemical analysis on incoming materials and chemicals. TI and TI suppliers consider certain information to be proprietary, and thus CAS numbers and other limited information may not be available for release.

In no event shall TI's liability arising out of such information exceed the total purchase price of the TI part(s) at issue in this document sold by TI to Customer on an annual basis.

N0020A

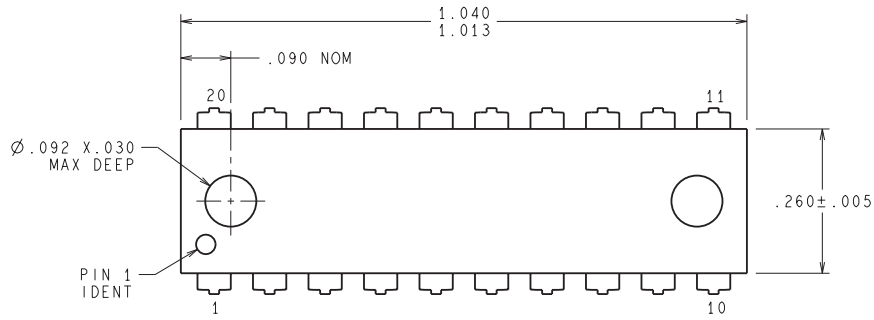

OPTION 1

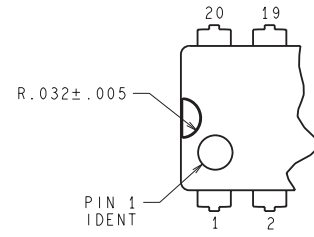

OPTION 2

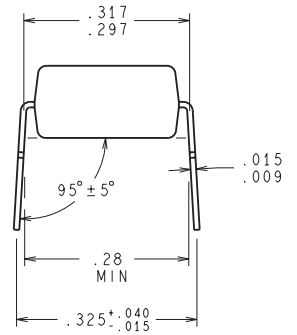
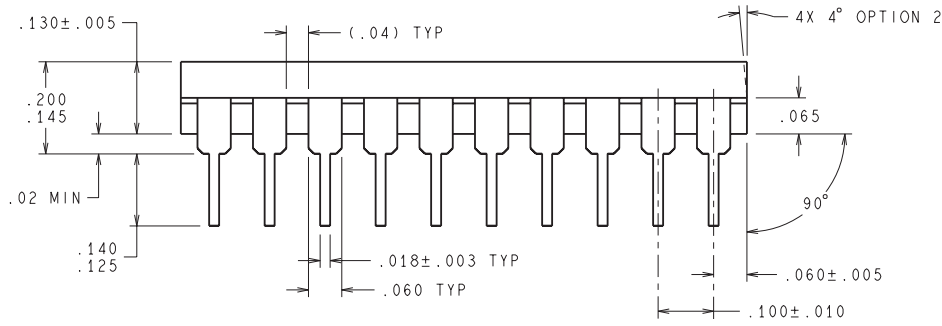

N20A (Rev G)

DW0020A



PACKAGE OUTLINE

SOIC - 2.65 mm max height

SOIC



4220724/A 05/2016

NOTES:

1. All linear dimensions are in millimeters. Dimensions in parenthesis are for reference only. Dimensioning and tolerancing per ASME Y14.5M.
2. This drawing is subject to change without notice.
3. This dimension does not include mold flash, protrusions, or gate burrs. Mold flash, protrusions, or gate burrs shall not exceed 0.15 mm per side.
4. This dimension does not include interlead flash. Interlead flash shall not exceed 0.43 mm per side.
5. Reference JEDEC registration MS-013.

EXAMPLE BOARD LAYOUT

DW0020A

SOIC - 2.65 mm max height

SOIC



LAND PATTERN EXAMPLE
SCALE:6X



SOLDER MASK DETAILS

4220724/A 05/2016

NOTES: (continued)

- 6. Publication IPC-7351 may have alternate designs.
- 7. Solder mask tolerances between and around signal pads can vary based on board fabrication site.

EXAMPLE STENCIL DESIGN

DW0020A

SOIC - 2.65 mm max height

SOIC



SOLDER PASTE EXAMPLE
BASED ON 0.125 mm THICK STENCIL
SCALE:6X

4220724/A 05/2016

NOTES: (continued)

8. Laser cutting apertures with trapezoidal walls and rounded corners may offer better paste release. IPC-7525 may have alternate design recommendations.
9. Board assembly site may have different recommendations for stencil design.

IMPORTANT NOTICE

Texas Instruments Incorporated and its subsidiaries (TI) reserve the right to make corrections, enhancements, improvements and other changes to its semiconductor products and services per JESD46, latest issue, and to discontinue any product or service per JESD48, latest issue. Buyers should obtain the latest relevant information before placing orders and should verify that such information is current and complete. All semiconductor products (also referred to herein as "components") are sold subject to TI's terms and conditions of sale supplied at the time of order acknowledgment.

TI warrants performance of its components to the specifications applicable at the time of sale, in accordance with the warranty in TI's terms and conditions of sale of semiconductor products. Testing and other quality control techniques are used to the extent TI deems necessary to support this warranty. Except where mandated by applicable law, testing of all parameters of each component is not necessarily performed.

TI assumes no liability for applications assistance or the design of Buyers' products. Buyers are responsible for their products and applications using TI components. To minimize the risks associated with Buyers' products and applications, Buyers should provide adequate design and operating safeguards.

TI does not warrant or represent that any license, either express or implied, is granted under any patent right, copyright, mask work right, or other intellectual property right relating to any combination, machine, or process in which TI components or services are used. Information published by TI regarding third-party products or services does not constitute a license to use such products or services or a warranty or endorsement thereof. Use of such information may require a license from a third party under the patents or other intellectual property of the third party, or a license from TI under the patents or other intellectual property of TI.

Reproduction of significant portions of TI information in TI data books or data sheets is permissible only if reproduction is without alteration and is accompanied by all associated warranties, conditions, limitations, and notices. TI is not responsible or liable for such altered documentation. Information of third parties may be subject to additional restrictions.

Resale of TI components or services with statements different from or beyond the parameters stated by TI for that component or service voids all express and any implied warranties for the associated TI component or service and is an unfair and deceptive business practice. TI is not responsible or liable for any such statements.

Buyer acknowledges and agrees that it is solely responsible for compliance with all legal, regulatory and safety-related requirements concerning its products, and any use of TI components in its applications, notwithstanding any applications-related information or support that may be provided by TI. Buyer represents and agrees that it has all the necessary expertise to create and implement safeguards which anticipate dangerous consequences of failures, monitor failures and their consequences, lessen the likelihood of failures that might cause harm and take appropriate remedial actions. Buyer will fully indemnify TI and its representatives against any damages arising out of the use of any TI components in safety-critical applications.

In some cases, TI components may be promoted specifically to facilitate safety-related applications. With such components, TI's goal is to help enable customers to design and create their own end-product solutions that meet applicable functional safety standards and requirements. Nonetheless, such components are subject to these terms.

No TI components are authorized for use in FDA Class III (or similar life-critical medical equipment) unless authorized officers of the parties have executed a special agreement specifically governing such use.

Only those TI components which TI has specifically designated as military grade or "enhanced plastic" are designed and intended for use in military/aerospace applications or environments. Buyer acknowledges and agrees that any military or aerospace use of TI components which have **not** been so designated is solely at the Buyer's risk, and that Buyer is solely responsible for compliance with all legal and regulatory requirements in connection with such use.

TI has specifically designated certain components as meeting ISO/TS16949 requirements, mainly for automotive use. In any case of use of non-designated products, TI will not be responsible for any failure to meet ISO/TS16949.

Products

Audio	www.ti.com/audio
Amplifiers	amplifier.ti.com
Data Converters	dataconverter.ti.com
DLP® Products	www.dlp.com
DSP	dsp.ti.com
Clocks and Timers	www.ti.com/clocks
Interface	interface.ti.com
Logic	logic.ti.com
Power Mgmt	power.ti.com
Microcontrollers	microcontroller.ti.com
RFID	www.ti-rfid.com
OMAP Applications Processors	www.ti.com/omap
Wireless Connectivity	www.ti.com/wirelessconnectivity

Applications



Automotive and Transportation	www.ti.com/automotive
Communications and Telecom	www.ti.com/communications
Computers and Peripherals	www.ti.com/computers
Consumer Electronics	www.ti.com/consumer-apps
Energy and Lighting	www.ti.com/energy
Industrial	www.ti.com/industrial
Medical	www.ti.com/medical
Security	www.ti.com/security
Space, Avionics and Defense	www.ti.com/space-avionics-defense
Video and Imaging	www.ti.com/video

TI E2E Community

e2e.ti.com

Looking for pricing, stock, or lifecycle information?

Click below to explore more details on WIN SOURCE:

-  [View LM1036N](#) on WIN SOURCE
-  [Texas Instruments](#) Information

Optimize Your Supply Chain with WIN SOURCE Solutions

-  Global Sourcing Solution
-  Obsolete Management
-  Cost Control Management
-  Shortage Management
-  Alternative Solution
-  Excess Inventory Management