



**THE DATASHEET OF
LEMF2520T150K**



巻線チップインダクタ

WOUND CHIP INDUCTORS

LE SERIES M TYPE

OPERATING TEMP. -40~+85°C

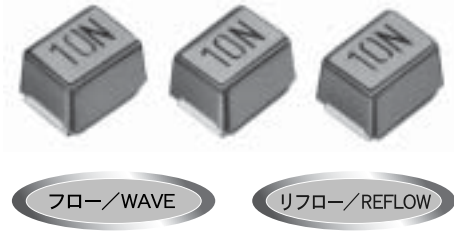

特長 FEATURES

- ・アキシヤルリード形インダクタの製造工程・基本構造を継承した量産性に優れた高品質のインダクタ
- ・耐熱樹脂成形による優れた耐熱性と機械的強度を有したインダクタ
- ・ A high-quality inductor that is simple to mass-produce and conforms to the same production process and basic construction as an axial lead type inductor.
- ・ Constructed of heat-resistant molded resin having excellent heat resistance and mechanical strength.

用途 APPLICATIONS

VTRカメラ、HDD、FDD、液晶TV、カーオーディオ、移動体通信、その他小型電子機器一般

Video cameras, hard disk drives, floppy disk drives, liquid crystal television sets, car audio equipment, mobile communications and other small-sized general electronic appliances.

形名表記法 ORDERING CODE

1	3	5	6
形式	外径寸法 (mm)	公称インダクタンス [μ H]	インダクタンス許容差 [%]
LE 巻線チップインダクタ	2520(1008) 2.5×2.0 3225(1210) 3.2×2.5	例 10N 0.010 R10 0.1 1R0 1 101 100	J ± 5 K ± 10 M ± 20
2	4	*R=小数点 *N=nHとしての小数点	
形状	包装	7	
M Δ 角形 MC 角形/大電流 MF 角形/低Rdc	B Δ 単品 T Δ テーピング Δ =スペース	当社管理記号 $\Delta\Delta\Delta\Delta$ 標準品 Δ =スペース	
Δ =スペース			



1	3	5	6
Type	External Dimensions (mm)	Nominal Inductance [μ H]	Inductance Tolerances [%]
LE Wound chip inductor	2520(1008) 2.5×2.0 3225(1210) 3.2×2.5	example 10N 0.010 R10 0.1 1R0 1 101 100	J ± 5 K ± 10 M ± 20
2	4	*R=decimal point *N=0.0(nH type)	
Shape	Packaging	7	
M Δ Rectangular Type MC Rectangular / High current Type MF Rectangular / Low Rdc	B Δ Bulk T Δ Tape & Reel Δ =Blank space	Internal code $\Delta\Delta\Delta\Delta$ Standard Products Δ =Blank space	
Δ =Blank space			

外形寸法 EXTERNAL DIMENSIONS

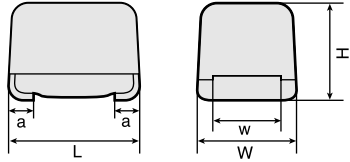
Type	LEM2520/LEMC2520/LEMF2520 (1008)	LEMC3225 / LEMF3225 (1210)
Fig.		
L	2.5±0.2 (0.098±0.008)	3.2±0.2 (0.126±0.008)
W	2.0±0.2 (0.079±0.008)	2.5±0.2 (0.098±0.008)
H	1.8±0.2 (0.071±0.008)	2.2±0.2 (0.087±0.008)
a	0.45 (0.018)	0.45 (0.018)
w	1.4±0.1 (0.055±0.004)	1.9±0.1 (0.075±0.004)

Unit : mm(inch)

概略バリエーション AVAILABLE INDUCTANCE RANGE

Range		Type	LEM2520	LEMC2520	LEMF2520	LEMC3225	LEMF3225
			I _{max} [mA] Inductance R _{dc} [Ω]	I _{max} [mA] R _{dc} [Ω]	I _{max} [mA] R _{dc} [Ω]	I _{max} [mA] R _{dc} [Ω]	I _{max} [mA] R _{dc} [Ω]
高周波タイプ High frequency	Inductance [nH]	10	530 10nH 0.26				
		100	280 0.80				
一般タイプ/大電流タイプ Ordinary type/High Current type	Inductance [μH]	1.0	245 1.10	475 1.0μH 0.25 ±30%	455 1.0μH 0.13 ±30%	850 1.0μH 0.1 ±30%	500 1.0μH 0.06 ±30%
		10	155 3.50	210 1.5 ±30%	155 0.5 ±30%	300 0.41 ±30%	165 0.22 ±30%
		100	60 21.00	33μH	40 100μH 5.5 ±30%	100 4.3 ±30%	55 2.1 ±30%
				100μH		330μH	330μH

代 表 値 Examples	inductance	I max [mA]	Rdc [Ω]	I max [mA]	Rdc [Ω]	I max [mA]	Rdc [Ω]	I max [mA]	Rdc [Ω]	I max [mA]	Rdc [Ω]
	10nH	530	0.26	—	—	—	—	—	—	—	—
	100nH	280	0.80	—	—	—	—	—	—	—	—
	1μH	245	1.10	475	0.25±30%	455	0.13±30%	850	0.10±30%	500	0.06±30%
	10μH	155	3.50	210	1.5±30%	155	0.50±30%	300	0.41±30%	165	0.22±30%
	100μH	60	21.00	—	—	40	5.50±30%	100	4.30±30%	55	2.1±30%

セレクトションガイド
Selection Guide

アイテム一覧
Part Numbers

特性図
Electrical Characteristics

梱包
Packaging

信頼性
Reliability Data

使用上の注意
Precautions



etc

LEM2520 TYPE

高周波タイプ High frequency type

形名 Ordering code	公称 インダクタンス Inductance [nH]	インダクタンス 許容差 Inductance Tolerance	Q min.	LQ 測定 周波数 Measuring frequency [MHz]	Q (参考値) (Typical)					自己共振周波数 Self-resonant frequency [MHz]		直流抵抗 DC Resistance [Ω] max.	定格電流 Rated current [mA] max.
					周波数 Frequency [MHz]					min.	typ.		
					100	300	500	800	1000				
LEM2520□10NK	10	±10%	10	100	25	37	45	52	57	2150	4300	0.26	530
LEM2520□12NK	12				26	38	45	52	54	2050	3900	0.27	500
LEM2520□15NK	15				26	38	46	51	51	1850	3500	0.31	480
LEM2520□18NK	18				26	40	48	52	51	1650	3100	0.34	450
LEM2520□22NK	22				28	43	51	56	50	1550	2700	0.38	420
LEM2520□27NK	27		29		44	50	51	48	1400	2450	0.42	410	
LEM2520□33NK	33		30		45	51	50	43	1250	2200	0.46	400	
LEM2520□39NK	39		30		45	50	39	42	1100	2000	0.50	380	
LEM2520□47NK	47		30		44	48	43	35	1050	1800	0.56	360	
LEM2520□56NK	56		31		44	42	35	25	950	1600	0.65	340	
LEM2520□68NK	68	31	41	38	27	17	900	1500	0.70	320			
LEM2520□82NK	82	32	44	40	29	17	850	1300	0.75	300			
LEM2520□R10K	100	32	41	36	20	8	700	1200	0.80	280			

・注：形名の□には包装記号が入ります。 ・□ Please specify the packaging code. (T: Tape & reel, B: Bulk)

一般タイプ Ordinary type

形名 Ordering code	公称 インダクタンス Inductance [μH]	インダクタンス 許容差 Inductance Tolerance	Q min.	測定 周波数 Measuring frequency [MHz]	自己共振 周波数 Self-resonant frequency [MHz] min.	直流抵抗 DC Resistance [Ω] max.	定格電流 Rated current [mA] max.
LEM2520□R12K	0.12	±10%	30	25.2	600	0.37	520
LEM2520□R15K	0.15				550	0.42	480
LEM2520□R18K	0.18				500	0.46	460
LEM2520□R22K	0.22				450	0.52	430
LEM2520□R27K	0.27				425	0.56	420
LEM2520□R33K	0.33				400	0.60	400
LEM2520□R39K	0.39				375	0.65	375
LEM2520□R47K	0.47				350	0.68	350
LEM2520□R56K	0.56				300	0.75	325
LEM2520□R68K	0.68				270	0.85	300
LEM2520□R82K	0.82	250	1.00	260			
LEM2520□1R0J	1.0	±5%	25	7.96	220	1.10	245
LEM2520□1R2J	1.2				180	1.20	230
LEM2520□1R5J	1.5				135	1.30	220
LEM2520□1R8J	1.8				100	1.45	210
LEM2520□2R2J	2.2				75	1.55	200
LEM2520□2R7J	2.7				55	1.70	195
LEM2520□3R3J	3.3				48	1.90	185
LEM2520□3R9J	3.9				43	2.10	180
LEM2520□4R7J	4.7				40	2.30	175
LEM2520□5R6J	5.6				36	2.50	170
LEM2520□6R8J	6.8	33	2.70	165			
LEM2520□8R2J	8.2	30	3.05	160			
LEM2520□100J	10	±5%	20	2.52	27	3.50	155
LEM2520□120J	12				23	3.80	150
LEM2520□150J	15				20	4.40	140
LEM2520□180J	18				18	4.80	130
LEM2520□220J	22				17	5.50	125
LEM2520□270J	27				16	6.30	115
LEM2520□330J	33				15	7.10	110
LEM2520□390J	39				14	9.50	90
LEM2520□470J	47				13	11.10	80
LEM2520□560J	56				12	12.10	75
LEM2520□680J	68	11	16.60	70			
LEM2520□820J	82	10	19.00	65			
LEM2520□101J	100	15	0.796	9	21.00	60	

・注：形名の□には包装記号が入ります。 ・□ Please specify the packaging code. (T: Tape & reel, B: Bulk)

LEMC2520 TYPE

大電流タイプ High current type

形名 Ordering code	公称 インダクタンス Inductance [μH]	インダクタンス 許容差 Inductance Tolerance	Q (参考値) (Typical)	測定 周波数 Measuring frequency [MHz]	自己共振 周波数 Self-resonant frequency [MHz] min.	直流抵抗 DC Resistance [Ω] (30%)	定格電流 Rated current [mA] max.
LEMC2520□1R0M	1.0	±20%	20	7.96	180	0.25	475
LEMC2520□1R5M	1.5				100	0.3	435
LEMC2520□2R2M	2.2				75	0.4	390
LEMC2520□3R3M	3.3				55	0.5	340
LEMC2520□4R7M	4.7				43	0.7	285
LEMC2520□6R8M	6.8				39	0.9	275
LEMC2520□100K	10	±10%	30	2.52	32	1.5	210
LEMC2520□150K	15				21	1.9	175
LEMC2520□220K	22				18	2.7	160
LEMC2520□330K	33				16	4.8	120

・注：形名の□には包装記号が入ります。 □ Please specify the packaging code. (T: Tape & reel, B: Bulk,)

LEMF2520 TYPE

低Rdcタイプ Low Rdc type

形名 Ordering code	公称 インダクタンス Inductance [μH]	インダクタンス 許容差 Inductance Tolerance	Q (参考値) (Typical)	測定 周波数 Measuring frequency [MHz]	自己共振 周波数 Self-resonant frequency [MHz] min.	直流抵抗 DC Resistance [Ω] (±30%)	定格電流 Rated current [mA] max.		
LEMF2520□1R0M	1.0	±20%	10	7.96	100	0.13	455		
LEMF2520□1R5M	1.5				80	0.17	350		
LEMF2520□2R2M	2.2				70	0.20	315		
LEMF2520□3R3M	3.3				55	0.25	280		
LEMF2520□4R7M	4.7				45	0.30	210		
LEMF2520□6R8M	6.8				38	0.35	175		
LEMF2520□100K	10	±10%	20	2.52	32	0.50	155		
LEMF2520□150K	15				28	1.00	130		
LEMF2520□220K	22				16	1.20	105		
LEMF2520□330K	33				14	2.10	85		
LEMF2520□470K	47				11	2.60	60		
LEMF2520□680K	68				10	3.30	50		
LEMF2520□101K	100				8	5.50	40		
						0.796			

・注：形名の□には包装記号が入ります。 □ Please specify the packaging code. (T: Tape & reel, B: Bulk,)

LEM3225 TYPE

大電流タイプ High current type

形名 Ordering code	公称 インダクタンス Inductance [μH]	インダクタンス 許容差 Inductance Tolerance	Q min.	測定 周波数 Measuring frequency [MHz]	自己共振 周波数 Self-resonant frequency [MHz] min.	直流抵抗 DC Resistance [Ω] (±30%)	定格電流 Rated current [mA] max.
LEM3225□1R0M	1.0	±20%	10	7.96	100	0.10	850
LEM3225□1R5M	1.5				80	0.12	700
LEM3225□2R2M	2.2				68	0.15	600
LEM3225□3R3M	3.3				54	0.18	500
LEM3225□4R7M	4.7				46	0.22	430
LEM3225□6R8M	6.8				38	0.29	360
LEM3225□100K	10	±10%	15	2.52	30	0.41	300
LEM3225□150K	15				26	0.55	250
LEM3225□220K	22				20	1.00	210
LEM3225□330K	33				17	1.30	170
LEM3225□470K	47				14	1.90	150
LEM3225□680K	68				12	3.30	120
LEM3225□101K	100		20	0.796	10	4.30	100
LEM3225□151K	150				8	6.30	85
LEM3225□221K	220				6	8.00	70
LEM3225□331K	330				5	13.00	60

・注：形名の□には包装記号が入ります。・□ Please specify the packaging code. (T: Tape & reel, B: Bulk,)

LEM3225 TYPE

低Rdcタイプ Low Rdc type

形名 Ordering code	公称 インダクタンス Inductance [μH]	インダクタンス 許容差 Inductance Tolerance	Q (参考値) (Typical)	測定 周波数 Measuring frequency [MHz]	自己共振 周波数 Self-resonant frequency [MHz] min.	直流抵抗 DC Resistance [Ω] (±30%)	定格電流 Rated current [mA] max.
LEM3225□1R0M	1.0	±20%	5	7.96	100	0.06	500
LEM3225□1R5M	1.5				80	0.08	400
LEM3225□2R2M	2.2				68	0.09	340
LEM3225□3R3M	3.3				54	0.11	270
LEM3225□4R7M	4.7				43	0.13	240
LEM3225□6R8M	6.8				35	0.17	195
LEM3225□100K	10	±10%	10	2.52	28	0.22	165
LEM3225□150K	15				24	0.30	145
LEM3225□220K	22				20	0.45	115
LEM3225□330K	33				17	0.65	95
LEM3225□470K	47				13	0.95	85
LEM3225□680K	68				11	1.3	70
LEM3225□101K	100		20	0.796	9	2.1	55
LEM3225□151K	150				7	3.2	45
LEM3225□221K	220				6	4.5	35
LEM3225□331K	330				4.5	7.0	30

・注：形名の□には包装記号が入ります。・□ Please specify the packaging code. (T: Tape & reel, B: Bulk,)

直流電流特性例 DC Bias characteristics(Measured by HP4285A+42841A)

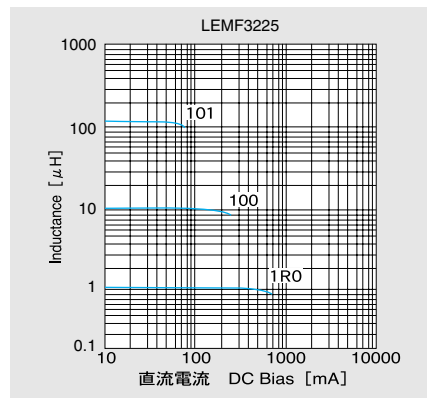
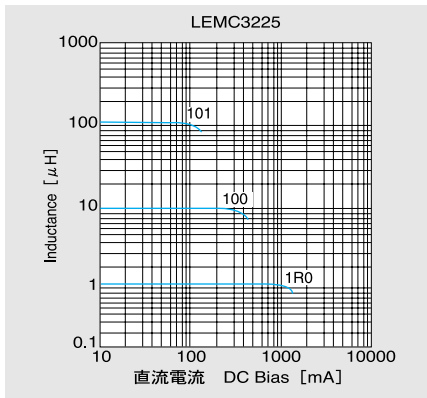
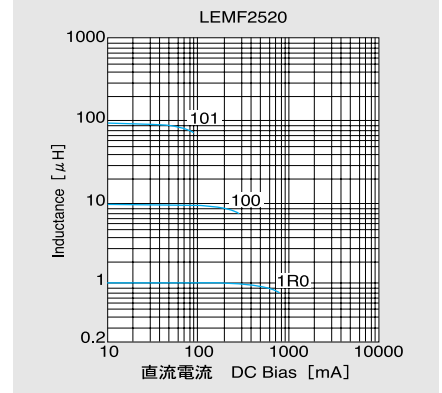
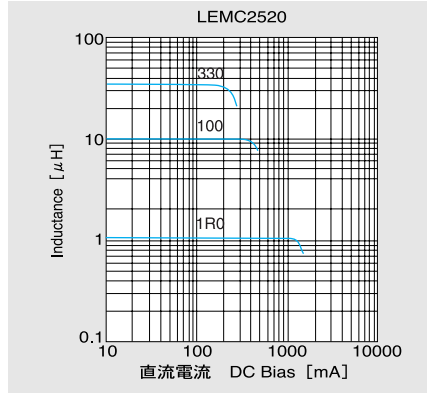
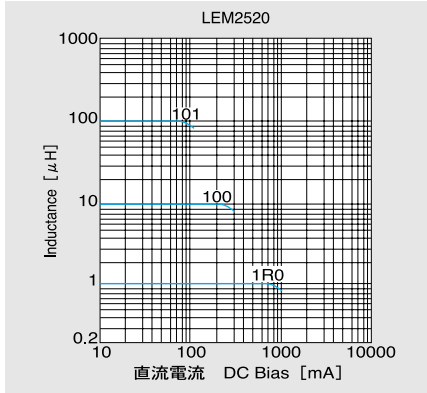

温度特性例 Temperature characteristics(Measured by HP4285A+42851A)

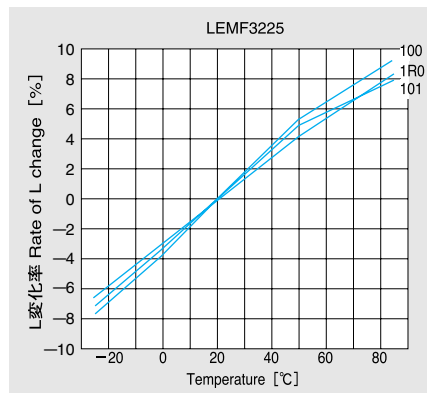
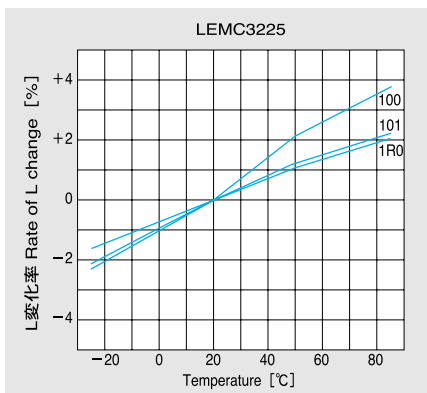
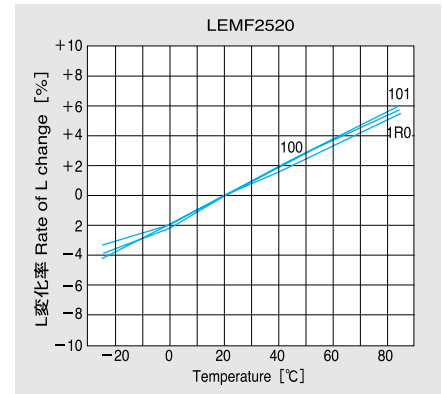
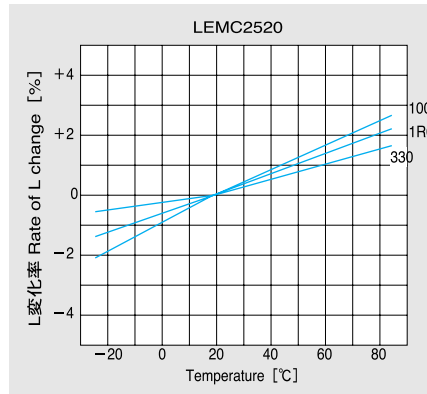
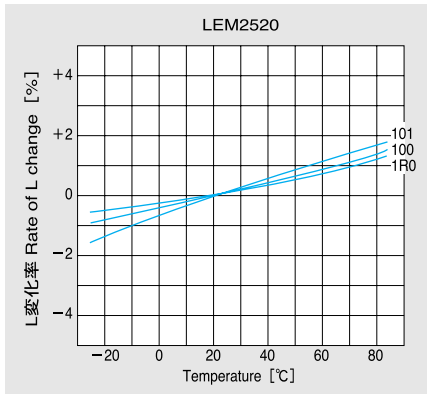

Q-周波数特性例 Q-Characteristics
 一般タイプ Ordinary type(Measured by HP4285A+42851A)

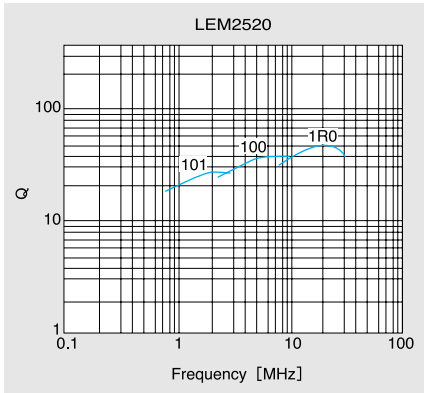

高周波タイプ High frequency type(Measured by HP8720B)

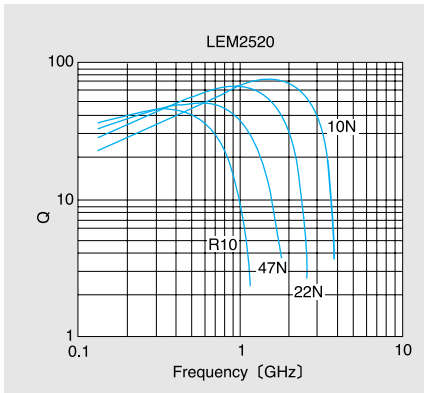

インピーダンス周波数特性例 Impedance-vs-Frequency characteristics(Measured by HP8720B)

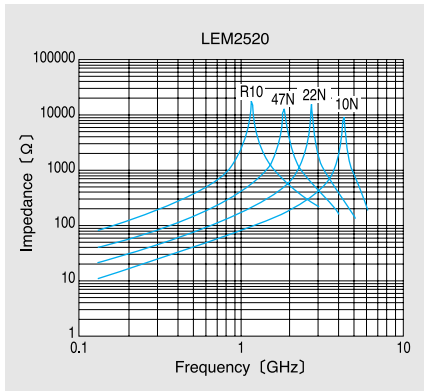

インダクタンス周波数特性例 Inductance-vs-Frequency characteristics(Measured by HP8720B)

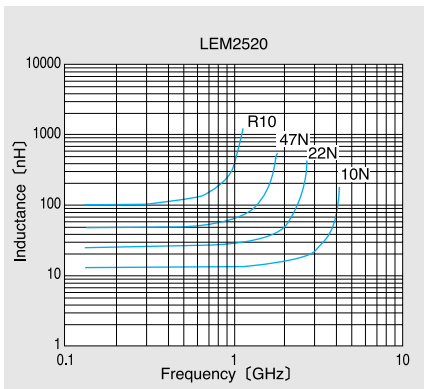

①標準数量 Standard Quantity

形式 Type	標準数量 Standard Quantity [pcs]	
	袋づめ Bulk / Bag	テーピング Tape&Reel
LEM2520/LEMC2520/LEMF2520	2000	2000
LEMC3225/LEMF3225	2000	2000
LER012	3000	3000
LER015	3000	3000

②テーピング材質 Tape material

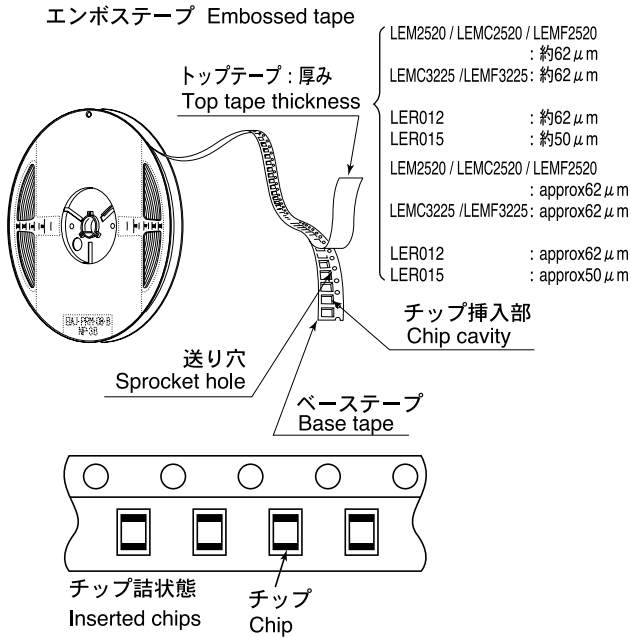

形式 Type	チップ挿入部 Chip Cavity		挿入ピッチ Insertion Pitch F	テープ厚み Tape Thickness	
	A	B		K	T
LEM2520/ LEMC2520/ LEMF2520	2.3±0.1 (0.091±0.004)	2.7±0.1 (0.106±0.004)	4.0±0.1 (0.157±0.004)	2.1 (0.083)	0.3 (0.012)
				±0.1 (±0.004)	±0.05 (±0.002)
LEMC3225/ LEMF3225	2.8±0.2 (0.110±0.008)	3.55±0.2 (0.140±0.008)	4.0±0.1 (0.157±0.004)	2.45 (0.096)	0.3 (0.012)
				±0.1 (0.004)	±0.05 (0.002)
LER012	1.45±0.2 (0.057±0.008)	2.43±0.2 (0.096±0.008)	4.0±0.1 (0.157±0.004)	2.0 (0.079)	0.3 (0.012)
				max.	max.
LER015	2.0±0.2 (0.079±0.008)	3.6±0.2 (0.142±0.008)	4.0±0.1 (0.157±0.004)	2.0 (0.079)	0.3 (0.012)
				max.	±0.05 (±0.002)

Unit: mm (inch)

④リーダー部/空部 Leader and Blank Portion

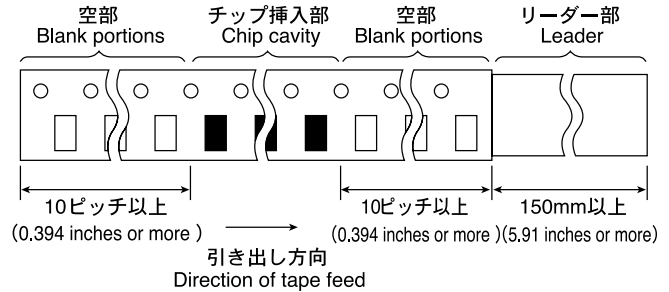

③テーピング寸法 Taping Dimensions

エンボステープ (8mm幅) Embossed Tape (0.315 inches wide)

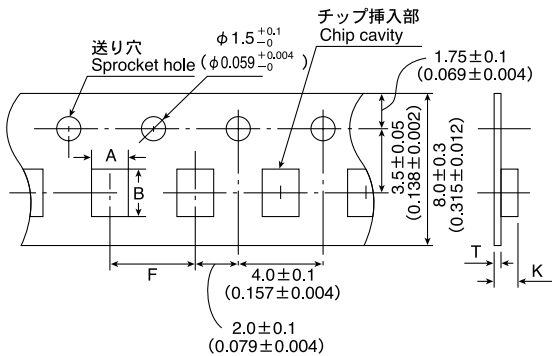

⑤ リール寸法 Reel Size

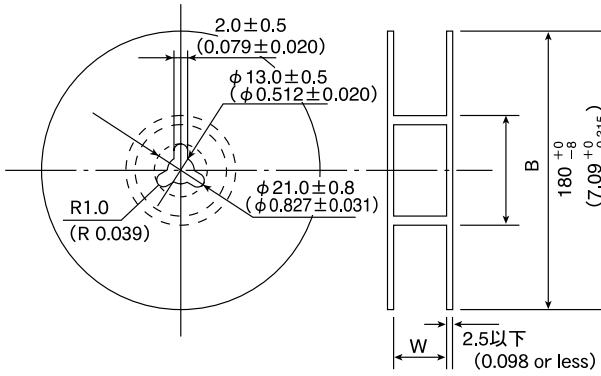

Unit: mm (inch)

形式 Type	W	B
LER012	9±0.8 (0.354±0.031)	60 ⁺¹ ₋₀ (2.36 ^{+0.039} ₋₀)
LER015	10.0±1.5 (0.394±0.059)	50±1 (1.97±0.039)
LEM2520 LEMC2520 LEMF2520	9±0.8 (0.354±0.031)	60 ⁺¹ ₋₀ (2.36 ^{+0.039} ₋₀)
LEMC3225 LEMF3225	9±0.8 (0.354±0.031)	60 ⁺¹ ₋₀ (2.36 ^{+0.039} ₋₀)

⑥ トップテープ強度 Top Tape Strength

トップテープのはがし力は、下図矢印方向にて0.2~0.7Nとなります。
The top tape requires a peel-off force of 0.2 to 0.7N in the direction of the arrow as illustrated below.

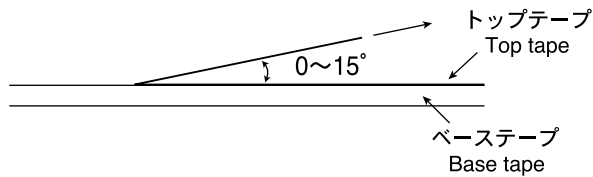

Item	Specified Value											Test Methods and Remarks	
	LER012 LER015	LEM2520	LEMC2520	LEMF2520	LEMC3225	LEMF3225	LB2518	LB2016	LB2012	LB1608	LBC2518		LBH1608
1. Operating temperature Range	-25~+85°C	-40~+85°C					-25~+85°C						
2. Storage	-40~+85°C					-25~+85°C							
3. Rated Voltage	Within the specified tolerance											<p>The maximum DC value having inductance decrease within 10% and temperature increases within 20°C by the application of DC bias.</p> <p>LBH1608 · LEM Series 5N6~R10: The maximum DC value having temperature increases within 20°C by the application of DC bias.</p>	
4. Inductance	Within the specified tolerance											<p>LER · LEM Series 5N6~R10 : Measuring equipment : Impedance analyzer (HP4291A or its equivalent) Measuring frequency : Specified frequency</p> <p>LER · LEM Series R12~221 : Measuring equipment : LCR Meter (HP4285A+42851A or its equivalent) Measuring frequency : Specified frequency</p> <p>LB · LBC Series : Measuring equipment : LCR Meter (HP4285A or its equivalent)</p> <p>LBH1608 Series : Measuring equipment : Impedance analyzer (HP4291A or its equivalent)</p>	
5. Q	Within the specified tolerance										12~18 (at 100MHz) min	<p>LER · LEM Series 5N6~R10 : Measuring equipment : Impedance analyzer (HP4291A or its equivalent) Measuring frequency : Specified frequency</p> <p>LER · LEM Series R12~221 : Measuring equipment : LCR Meter (HP4285A+42851A or its equivalent) Measuring frequency : Specified frequency</p> <p>LB · LBC Series : Measuring equipment : LCR Meter (HP4285A or its equivalent)</p> <p>LBH1608 Series : Measuring equipment : Impedance analyzer (HP4291A or its equivalent)</p>	
6. DC Resistance	Within the specified tolerance											<p>LER · LEM · LB · LBC · LBH Series : Measuring equipment : low ohmmeter (A&D AD5812 or its equivalent)</p>	

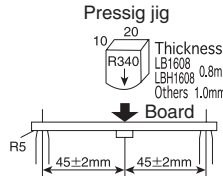
Item	Specified Value												Test Methods and Remarks												
	LER012 LER015	LEM2520	LEMC2520	LEMF2520	LEMC3225	LEMF3225	LB2518	LB2016	LB2012	LB1608	LBC2518	LBH1608													
7. Self-Resonant Frequency	Within the specified tolerance												LER・LEM Series 5N6~R10 : Measuring equipment : Network analyzer (HP8720B or its equivalent) LER・LEM Series (Exclude LEM2520) R12~ : Measuring equipment : Impedance analyzer (HP4291A or its equivalent) LEM2520 : Measuring equipment : Network analyzer (Anritsu MS620J or its equivalent) LB・LBC Series : Measuring equipment : Impedance analyzer (HP4291A or its equivalent) LBH1608 Series : Measuring equipment : Network analyzer (HP8720B or its equivalent)												
8. Temperature Characteristic	$\Delta L/L \rightarrow$ Within $\pm 5\%$		$\Delta L/L \rightarrow$ Within $\pm 10\%$	$\Delta L/L \rightarrow$ Within $\pm 5\%$	$\Delta L/L \rightarrow$ Within $\pm 15\%$			$\Delta L/L \rightarrow$ Within $\pm 15\%$				$\Delta L/L \rightarrow$ Within $\pm 5\%$ ※ $\Delta L/L \rightarrow$ Within $\pm 0.5nH$ under 8.2nH	Change of maximum inductance deviation in step 1-5 * Exclude CM03MS series <table border="1"> <thead> <tr> <th>Step</th> <th>Temperature (°C)</th> </tr> </thead> <tbody> <tr> <td>1</td> <td>20</td> </tr> <tr> <td>2</td> <td>-25</td> </tr> <tr> <td>3</td> <td>20 (Reference temperature)</td> </tr> <tr> <td>4</td> <td>+85 (Maximum operating temperature)</td> </tr> <tr> <td>5</td> <td>20</td> </tr> </tbody> </table>	Step	Temperature (°C)	1	20	2	-25	3	20 (Reference temperature)	4	+85 (Maximum operating temperature)	5	20
Step	Temperature (°C)																								
1	20																								
2	-25																								
3	20 (Reference temperature)																								
4	+85 (Maximum operating temperature)																								
5	20																								
9. Resistance to Flexure of Substrate	No breakdown or damage												Warp: 2mm (LER012, LER015, LBC, LB) : 3mm (LEM2520, LEMC2520, LEMF2520, LEMC3225, LEMF3225) Test substrate: Printed board According to JIS C0051 Pressig jig 												
10. Body Strength	No breakdown or damage												LER012・LER015 Applide force : 15N Duration : 5sec. LB・LBC・LBH LEM2520・LEMC2520・LEMF2520・ LEMC3225・LEMF3225 Applide force : 10N Duration : 10sec. LB1608 Applide force : 5N Duration : 10sec.												
11. Self Resonant Frequency	$\Delta L/L \rightarrow$ Within -10%												Measure inductance with application of rated current using LCR metre to compare it with the initial value. (* Excluding 5N6~R10)												

Item	Specified Value												Test Methods and Remarks
	LER012 LER015	LEM2520	LEMC2520	LEMF2520	LEMC3225	LEMF3225	LB2518	LB2016	LB2012	LB1608	LBC2518	LBH1608	
12. Adhesion of terminal electrode	Shall not come off PC board.	No detachment of electrode					Shall not come off PC board.						LER012 · LER015 Applied force : 15N Duration : 5 sec. Test substrate : Printed board LB · LBC · LBH LEM2520 · LEMC2520 · LEMF2520 · LEMC3225 · LEMF3225 Applied force : 10N to X and Y directions Duration : 5 sec. Test substrate : Printed board
13. Resistance to vibration	$\Delta L/L \rightarrow$ Within $\pm 5\%$ Q \rightarrow R12~1R0 : 25min. 1R2~3R3 : 20min. $\Delta L/L \rightarrow$ Within $\pm 5\%$ Q \rightarrow R12~100 : 30min. 120~220 : 20min.	$\Delta L/L \rightarrow$ Within $\pm 5\%$ No significant abnormality in appearance.					$\Delta L/L \rightarrow$ Within $\pm 10\%$ No significant abnormality in appearance.						LER · LEM · LB · LBC : According to JIS C5102 clause 8.2. Vibration type : A Directions : 2 hrs each in X, Y and Z directions. Total : 6 hrs Frequency range : 10 to 55 to 10 Hz (1min.) Amplitude : 1.5mm Mounting method : Soldering onto printed board (* Excluding 5N6-R10 LE Series) Recovery : At least 1 hr of recovery under the standard condition after the test, followed by the measurement within 2 hrs.

Item	Specified Value												Test Methods and Remarks
	LER012 LER015	LEM2520	LEMC2520	LEMF2520	LEMC3225	LEMF3225	LB2518	LB2016	LB2012	LB1608	LBC2518	LBH1608	
14.Drop test	No significant abnormality in appearance.	△L/L→Within±5% No significant abnormality in appearance.				△L/L→ Within±10% No significant abnormality in appearance.							LER・LEM : LER012・LER015 Drop test Impact material : concreta or vinyl tile Height : 1m Total number of drops : 10 times LEM2520・LEMC2520・LEMF2520・ LEMC3225・LEMF3225 Acceleration : 980m/sec ² Duration : 6msec Number of times : 6 sides × 3 times Mounting method : Soldering onto printed board (* Excluding 10N~R10) Recovery : At least 1 hr of recovery under the standard condition after the
15.Solderability	At least 90% of electrode											test, followed by the measurement within 2 hrs. LER・LEM : Solder temperature : 230±5°C Duration : 2±0.5sec. (LER012・LER015) 5±0.5sec. (LEM2520・ LEMC2520・LEMF2520・ LEMC3225・LEMF3225) Flux : Methanol solution with 25% of colophony LB・LBH : Solder temperature : 230±5°C Duration : 5±0.5sec Flux : Methanol solution with 25% of colophony	

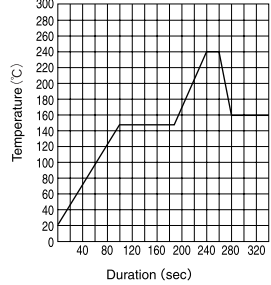
Item	Specified Value												Test Methods and Remarks
	LER012 LER015	LEM2520	LEMC2520	LEMF2520	LEMC3225	LEMF3225	LB2518	LB2016	LB2012	LB1608	LBC2518	LBH1608	
16. Resistance to soldering heat	No significant abnormality in appearance												Conduct following wave soldering twice. (LER012)  Solder temperature : 260±5°C Duration : 5±0.5sec. Twice (LERO15) 10±1sec. Once (LEM2520 · LEMC2520 · LEMF2520 · LEMC3225 · LEMF3225) LB · LBH : 3 times of reflow oven at 220 ± 5°C for 40sec. with peak temperature at 235± 5°C for 5sec.
17. Resistance to solvent	No significant abnormality in appearance.												Solvent temperature : Room temperature Type of solvent : Chlorocarbon type (LEM2520 · LEMC2520 · LEMC3225) Isopropyl alcohol (LEMF2520 · LEMF3225 · LB · LBC) Cleaning conditions : Output : 20mW/cm ² Frequency : 28kHz Duration : 1 min Conduct ultrasonic cleaning. (LEM2520 · LEMC2520 · LEMC3225) 90s. Immersion and cleaning. (LEMF2520 · LEMF3225 · LB · LBC)

Item	Specified Value											Test Methods and Remarks													
	LER012 LER015	LEM2520	LEMC2520	LEMF2520	LEMC3225	LEMF3225	LB2518	LB2016	LB2012	LB1608	LBC2518		LBH1608												
18. Resisittance to solvent	ΔL/L→ Within±10% Q→ 5N6~18N : 10min. 22N~R10 : 15min. 15min. R12~1R0 : 20min. 25min. 1R2~3R3 : 30min. 20min. 5R6~330 : 25min. ΔL/L→ Within±10% Q→ 10N~18N : 10min. 22N~R10 : 15min. R12~100 : 30min. 120~220 : 20min.	ΔL/L→ Within±10% Q→ 10N : 10min. 12N~33N : 15min. 39N~R10 : 20min. R12~4R7 : 30min. 5R6~330 : 25min. 390~820 : 20min. 101 : 15min.	ΔL/L→Within±10%									ΔL/L→ Within±5% ※ΔL/L→ within±0.5nH under 8.2nH ΔQ/Q→ within±20% ※ΔQ/Q →within ±5 under 8.2nH	<p>Conditions for 1cycle</p> <table border="1"> <thead> <tr> <th>Step</th> <th>Temperature(C)①</th> <th>Temperature(C)②</th> <th>Duration(min)</th> </tr> </thead> <tbody> <tr> <td>1</td> <td>-25</td> <td>-40</td> <td>30</td> </tr> <tr> <td>2</td> <td>+85</td> <td>+85</td> <td>30</td> </tr> </tbody> </table> <p>Temperature ① for : LER012・LER015 Temperature ② for : LEM2520・LEMC2520・LEMF2520・ LEMC3225・LEMF3225 Number of cycle : 100 cycle Recovery : At least 1 hr of recovery the stan- dard condition after the removal from test chamber, followed by measurement within 2 hrs.</p> <p>LB・LBC・LBH : -40~+85°C, miantain times 30min. ,100 cycle Recovery : At least 1 hr of recovery under the standard condition after the test, followed by the measure- ment within 2 hrs.</p>	Step	Temperature(C)①	Temperature(C)②	Duration(min)	1	-25	-40	30	2	+85	+85	30
	Step	Temperature(C)①	Temperature(C)②	Duration(min)																					
1	-25	-40	30																						
2	+85	+85	30																						
19. Damp heat	ΔL/L→ Within±10% Q→ 5R6~18N : 10min. 22N~R10 : 15min. 15min. R12~1R0 : 20min. 25min. 1R2~3R3 : 30min. 20min. 5R6~330 : 25min. ΔL/L→ Within±10% Q→ 10N~18N : 10min. 22N~R10 : 15min. R12~100 : 30min. 120~220 : 20min.	ΔL/L→ Within±10% Q→ 10N : 10min. 12N~33N : 15min. 39N~R10 : 20min. R12~4R7 : 30min. 5R6~330 : 25min. 390~820 : 20min. 101 : 15min.	ΔL/L→Within±10%									ΔL/L→ Within±5% ※ΔL/L→ within±0.5nH under 8.2nH ΔQ/Q→ Within±20% ※ΔQ/Q →within ±5 under 8.2nH	<p>Temperature : 60±2°C Humidity : 90~95%RH Duration : 1000 hrs Recovery : At least 1 hr of recovery the stan- dard condition after the removal from test chamber, followed by measurement within 2 hrs.</p>												

Item	Specified Value											Test Methods and Remarks	
	LER012 LER015	LEM2520	LEMC2520	LEMF2520	LEMC3225	LEMF3225	LB2518	LB2016	LB2012	LB1608	LBC2518		LBH1608
20.Loading under damp heat	$\Delta L/L \rightarrow$ Within $\pm 10\%$ Q \rightarrow R12~1R0 : 25min. 1R2~3R3 : 20min. $\Delta L/L \rightarrow$ Within $\pm 10\%$ Q \rightarrow R12~100 : 30min. 120~220 : 20min.	$\Delta L/L \rightarrow$ Within $\pm 10\%$ Q \rightarrow R12~4R7 : 30min. 5R6~330 : 25min. 390~820 : 20min. 101 : 15min.	$\Delta L/L \rightarrow$ Within $\pm 10\%$									$\Delta L/L \rightarrow$ Within $\pm 5\%$ ※ $\Delta L/L \rightarrow$ within $\pm 0.5nH$ under 8.2 n H $\Delta Q/Q \rightarrow$ within $\pm 20\%$ ※ $\Delta Q/Q$ \rightarrow within ± 5 under 8.2 n H	LER · LEM · LB · LBC : Temperature : 60 $\pm 2^\circ C$ (Excluding nH range) Humidity : 90~95%RH Duration : 1000 hrs Applied current : Rated current Recovery : At least 1 hr of recovery the standard condition after the removal from test chamber, followed by measurement within 2 hrs.
21.Hirh temperaturte life test	$\Delta L/L \rightarrow$ Within $\pm 10\%$ Q \rightarrow 5R6~18N : 10min. 22N~R10 : 15min. 15min. R12~1R0 : 25min. 1R2~3R3 : 20min. $\Delta L/L \rightarrow$ Within $\pm 10\%$ Q \rightarrow 10N~18N : 10min. 22N~R10 : 15min. R12~100 : 30min. 120~220 : 20min.	$\Delta L/L \rightarrow$ Within $\pm 10\%$ Q \rightarrow 10N : 10min. 12N~33N : 15min. 39N~R10 : 20min. R12~4R7 : 30min. 5R6~330 : 25min. 390~820 : 20min. 101 : 15min.	$\Delta L/L \rightarrow$ Within $\pm 10\%$									LER · LEM : Temperature : 85 $\pm 2^\circ C$ Duration : 1000 hrs Recovery : At least 1 hr of recovery the standard condition after the removal from test chamber, followed by measurement within 2 hrs.	
22.Loading at high temperature	$\Delta L/L \rightarrow$ Within $\pm 10\%$ Q \rightarrow R12~1R0 : 25min. 1R2~3R3 : 20min. $\Delta L/L \rightarrow$ Within $\pm 10\%$ Q \rightarrow R12~100 : 30min. 120~220 : 20min.	$\Delta L/L \rightarrow$ Within $\pm 10\%$					$\Delta L/L \rightarrow$ Within $\pm 10\%$				$\Delta L/L \rightarrow$ Within $\pm 5\%$ ※ $\Delta L/L \rightarrow$ within $\pm 0.5nH$ under 8.2 n H $\Delta Q/Q \rightarrow$ Within $\pm 20\%$ ※ $\Delta Q/Q$ \rightarrow within ± 0.5 under 8.2 n H	LER · LB · LBC : Temperature : 85 $\pm 2^\circ C$ (Excluding nH range) Duration : 1000 hrs Applied current : Rated current Recovery : At least 1 hr of recovery the standard condition after the removal from test chamber, followed by measurement within 2 hrs.	

Item	Specified Value											Test Methods and Remarks	
	LER012 LER015	LEM2520	LEMC2520	LEMF2520	LEMC3225	LEMF3225	LB2518	LB2016	LB2012	LB1608	LBC2518		LBH1608
23.Low temperature life test	$\Delta L/L \rightarrow$ Within $\pm 10\%$ Q \rightarrow 5R6~18N : 10min. 22N~R10 : 15min. 15min. R12~1R0 : 20min. 25min. 1R2~3R3 : 30min. 20min. $\Delta L/L \rightarrow$ $\pm 10\%$ 以内 Q \rightarrow 10N~18N : 10min. 22N~R10 : 15min. R12~100 : 30min. 120~220 : 20min.	$\Delta L/L \rightarrow$ Within $\pm 10\%$ Q \rightarrow 10N : 10min. 12N~33N : 15min. 39N~R10 : 20min. R12~4R7 : 30min. 5R6~330 : 25min. 390~820 : 20min. 101 : 15min.	$\Delta L/L \rightarrow$ Within $\pm 10\%$									$\Delta L/L \rightarrow$ Within $\pm 5\%$ ※ $\Delta L/L \rightarrow$ within $\pm 0.5nH$ under 8.2 n H $\Delta Q/Q \rightarrow$ Within $\pm 20\%$ ※ $\Delta Q/Q$ \rightarrow within ± 5 under 8.2 n H	LER · LEM · LB · LBC · LBH Temperature : $-40 \pm 2^\circ C$ Duration : 1000 hrs Recovery : At least 1 hr of recovery the standard condition after the removal from test chamber, followed by measurement within 2 hrs.
24.Standard condition	"Standard condition" referred to herein defined as follows : 5 to 35°C of temperature, 45 to 85% relative humidity, and 86 to 106kPa of air pressure. When there are questions concerning measurement results : In order to provide correlation data, the test shall be conducted under condition of $20 \pm 2^\circ C$ of temperature, 45 to 85% to 106kPa of air pressure. Unless otherwise specified all the test are conducted under the "standard condition"					Standard test condition : Unless otherwise specified, Temperature $20 \pm 15^\circ C$ of temperature, $65 \pm 20\%$ of relative humidity. When there are question concerning measurement result : In order to provide correlation date, the test shall be condition of $20 \pm 2^\circ C$ of temperature, $65 \pm 5\%$ relative humidity. Inductance is in accordance with our measured value.							

PRECAUTIONS

LER Type, LEM Type, LB Type

Stages	Precautions	Technical considerations
1.Circuit Design	<p>Operating environment,</p> <p>1.The products described in this specification are intended for use in general electronic equipment,(office supply equipment, telecommunications systems, measuring equipment, and household equipment). They are not intended for use in mission-critical equipment or systems requiring special quality and high reliability (traffic systems, safety equipment, aerospace systems, nuclear control systems and medical equipment including life-support systems,) where product failure might result in loss of life, injury or damage. For such uses, contact TAIYO YUDEN Sales Department in advance.</p>	
2.PCB Design	<p>Land pattern design</p> <p>1.Please contact any of our offices for a land pattern, and refer to a recommended land pattern of specifications.</p>	
3.Considerations for automatic placement	<p>Adjustment of mounting machine</p> <p>1.Excessive impact load should not be imposed on the products when mounting onto the PC boards.</p> <p>2.Mounting and soldering conditions should be checked beforehand.</p>	<p>1. When installing products, care should be taken not to apply distortion stress as it may deform the products.</p>
4.Soldering	<p>Wave soldering</p> <p>1.Please refer to the specifications in the catalog for a wave soldering.</p> <p>Reflow soldering</p> <p>1.Please contact any of our offices for a reflow soldering, and refer to the recommended condition specified.</p> <p>2.LER012 Type, LB Type</p> <p>Reflow solderring only.</p> <p>Lead free soldering</p> <p>1.When using products with lead free soldering, we request to use them after confirming of adhesion, temperature of resistance to soldering heat, etc. sufficiently.</p> <p>Recommended conditions for using a soldering iron</p> <p>Put the soldering iron on the land-pattern.</p> <p>Soldering iron's temperature - Below 350 °C</p> <p>Duration - 3 seconds or less</p> <p>The soldering iron should not directly touch the inductor.</p>	<p>1.If products are used beyond the range of the recommended conditions, heat stresses may deform the products, and consequently degrade the reliability of the products.</p>
5.Cleaning	<p>Cleaning conditions</p> <p>LB Type</p> <p>1.Washing by supersonic waves shall be avoided.</p>	<p>LB Type</p> <p>1.If washing by supersonic waves, supersonic waves may cause broken products.</p>
6.Handling	<p>Handling</p> <p>1.Keep the inductors away from all magnets and magnetic objects.</p> <p>Breakaway PC boards (splitting along perforations)</p> <p>1.When splitting the PC board after mounting inductors, care should be taken not to give any stresses of deflection or twisting to the board.</p> <p>2.Board separation should not be done manually, but by using the appropriate devices.</p> <p>Mechanical considerations</p> <p>1.Please do not give the inductors any excessive mechanical shocks.</p>	<p>1.There is a case that a characteristic varies with magnetic influence.</p> <p>1.Planning pattern configurations and the position of products should be carefully performed to minimize stress.</p> <p>1.There is a case to be damaged by a mechanical shock.</p>
7.Storage conditions	<p>Storage</p> <p>1.To maintain the solderability of terminal electrodes and to keep the packing material in good condition, temperature and humidity in the storage area should be controlled.</p> <p>· Recommended conditions</p> <p>Ambient temperature 0~40°C</p> <p>Humidity Below 70% RH</p> <p>The ambient temperature must be kept below 30°C Even under ideal storage conditions, solderability of products electrodes may decrease as time passes. For this reason, LE type inductors should be used within one year from the time of delivery.</p> <p>LER type, LB type</p> <p>Please should be used within 6 months from the time of delivery.</p> <p>LE type</p> <p>In case of storage over 6 months, solderability shall be checked before actual usage.</p>	<p>1. Under a high temperature and humidity environment, problems such as reduced solderability caused by oxidation of terminal electrodes and deterioration of taping/packaging materials may take place.</p>

Looking for pricing, stock, or lifecycle information?

Click below to explore more details on WIN SOURCE:

 [View LEMF2520T150K on WIN SOURCE](#)

 [Taiyo Yuden Information](#)

Optimize Your Supply Chain with WIN SOURCE Solutions

-  Global Sourcing Solution
-  Obsolete Management
-  Cost Control Management
-  Shortage Management
-  Alternative Solution
-  Excess Inventory Management