

Surface Mount

Monolithic Amplifier

LEE-9+

50Ω DC to 8 GHz

The Big Deal

- Low Gain
- Excellent Gain flatness, ± 0.5 dB up to 8 GHz
- Broadband matched



Generic photo used for illustration purposes only

3mm x 3mm MCLP package

Product Overview

LEE-9+ (RoHS compliant) is wideband current driven amplifier fabricated using HBT technology. In addition, the LEE-9+, has good input and output return loss over a broad frequency range without the need for external matching components. Lead finish is SnAgNi. It has repeatable performance from lot to lot and is enclosed in a 3mm x 3mm x 0.89mm MCLP package for very good thermal performance.

Key Features

Feature	Advantages
Broadband, DC* to 8 GHz (* Low frequency cut off determined by external coupling capacitors)	A single amplifier covering DC* to C band. <ul style="list-style-type: none">• Reduced component inventory• Ideal for wideband applications such as instrumentation and military
Low gain: 8.5 dB typ. at 0.1 GHz and 7.7 dB at 8 GHz	Ideal for increasing the gain of amplifier chain by low value. Typically small gain change may need two components; an amplifier and an attenuator. Use of LEE-9+ reduces component count.
Outstanding Gain Flatness: ± 0.4 dB	No need for gain flatness compensation over 8 GHz band to realize published gain flatness.
Wideband matched Input return loss: 17-29 dB typ. Output return loss: 12-34 dB typ.	No external matching required to realize published return loss.
MCLP Package	Low inductance, repeatable transitions, excellent thermal pad.

Notes

- A. Performance and quality attributes and conditions not expressly stated in this specification document are intended to be excluded and do not form a part of this specification document.
B. Electrical specifications and performance data contained in this specification document are based on Mini-Circuit's applicable established test performance criteria and measurement instructions.
C. The parts covered by this specification document are subject to Mini-Circuits standard limited warranty and terms and conditions (collectively, "Standard Terms"); Purchasers of this part are entitled to the rights and benefits contained therein. For a full statement of the Standard Terms and the exclusive rights and remedies thereunder, please visit Mini-Circuits' website at www.minicircuits.com/MCLStore/terms.jsp



Surface Mount

Monolithic Amplifier

DC-8 GHz

Product Features

- DC-8 GHz
- Gain, 8.4 dB typ. at 2 GHz
- Outstanding gain flatness, ± 0.5 dB typ.
- Output power, 13.9 dBm typ. at 2 GHz
- Internally Matched to 50 Ohms
- Aqueous washable
- Protected by US Patent 6,943,629



Generic photo used for illustration purposes only

LEE-9+

CASE STYLE: FG873

+RoHS Compliant

The +Suffix identifies RoHS Compliance. See our web site for RoHS Compliance methodologies and qualifications

Typical Applications

- Cellular
- PCS
- Communication receivers & transmitters
- Satellite communication, military

General Description

LEE-9+ (RoHS compliant) is a wideband amplifier offering medium dynamic range. It has repeatable performance from lot to lot. It is enclosed in a 3X3mm MCLP molded plastic package.

simplified schematic and pin description

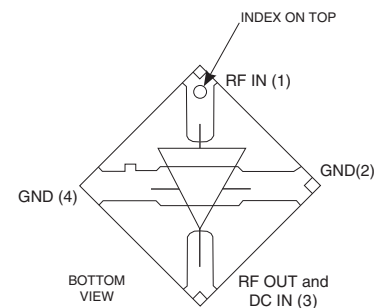
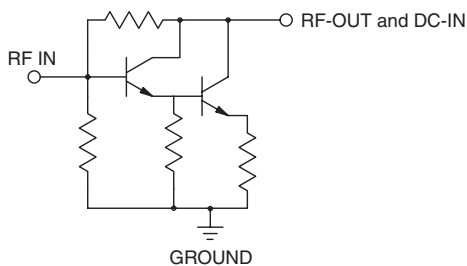

Function	Pin Number	Description
RF IN	1	RF input pin. This pin requires the use of an external DC blocking capacitor chosen for the frequency of operation.
RF-OUT and DC-IN	3	RF output and bias pin. DC voltage is present on this pin; therefore a DC blocking capacitor is necessary for proper operation. An RF choke is needed to feed DC bias without loss of RF signal due to the bias connection, as shown in "Recommended Application Circuit".
GND	2,4	Connections to ground. Use via holes as shown in "Suggested Layout for PCB Design" to reduce ground path inductance for best performance.

Notes

- Performance and quality attributes and conditions not expressly stated in this specification document are intended to be excluded and do not form a part of this specification document.
- Electrical specifications and performance data contained in this specification document are based on Mini-Circuit's applicable established test performance criteria and measurement instructions.
- The parts covered by this specification document are subject to Mini-Circuits' standard limited warranty and terms and conditions (collectively, "Standard Terms"); Purchasers of this part are entitled to the rights and benefits contained therein. For a full statement of the Standard Terms and the exclusive rights and remedies thereunder, please visit Mini-Circuits' website at www.minicircuits.com/MCLStore/terms.jsp



Electrical Specifications¹ at 25°C and 50mA, unless noted

Parameter	Condition (GHz)	Min.	Typ.	Max.	Units
Frequency Range ²		DC		8	GHz
Gain	0.1	—	8.5	—	dB
	1	—	8.5	—	
	2	7.6	8.4	9.3	
	4	—	8.2	—	
	5	—	8.0	—	
	8	—	7.7	—	
Input Return Loss	0.1		24.0		dB
	1		23.8		
	2		22.6		
	4		20.2		
	5		23.1		
	8		23.5		
Output Return Loss	0.1		33.0		dB
	1		29.7		
	2		26.1		
	4		22.0		
	5		20.9		
	8		13.3		
Output IP3	0.1		31.3		dBm
	1		30.5		
	2		29.7		
	4		25.4		
	5		23.4		
	8		19.7		
Output Power @ 1 dB compression	0.1	—	14.1	—	dBm
	1	—	14.0	—	
	2	12.0	13.9	—	
	4	—	12.4	—	
	5	—	11.9	—	
	8	—	7.9	—	
Noise Figure	0.1		5.1		dB
	1		5.1		
	2		5.3		
	4		5.3		
	5		5.2		
	8		5.3		
Recommended Device Operating Current (Id)			50		mA
Device Operating Voltage (Vd)		3.6	4.0	4.4	V
Device Voltage Variation vs. Temperature at 50 mA			-2.7		mV/°C
Device Voltage Variation vs. Current at 25°C			17.3		mV/mA
Thermal Resistance, junction-to-case			138		°C/W

- 1. Measured on Mini-Circuits test board TB-154
- 2. Low frequency cut off determined by external coupling capacitors.

Absolute Maximum Ratings³

Parameter	Ratings
Operating Temperature (ground lead)	-40°C to 85°C
Storage Temperature	-65°C to 150°C
Operating Current	74 mA
Input Power ⁴	26 dBm (5 min max.) 15 dBm (continuous)

- 3. Permanent damage may occur if any of these limits are exceeded. These ratings are not intended for continuous normal operation.
- 4. For continuous operation 15 dBm max.

Notes

- A. Performance and quality attributes and conditions not expressly stated in this specification document are intended to be excluded and do not form a part of this specification document.
- B. Electrical specifications and performance data contained in this specification document are based on Mini-Circuit's applicable established test performance criteria and measurement instructions.
- C. The parts covered by this specification document are subject to Mini-Circuits standard limited warranty and terms and conditions (collectively, "Standard Terms"); Purchasers of this part are entitled to the rights and benefits contained therein. For a full statement of the Standard Terms and the exclusive rights and remedies thereunder, please visit Mini-Circuits' website at www.minicircuits.com/MCLStore/terms.jsp



Characterization Test Circuit

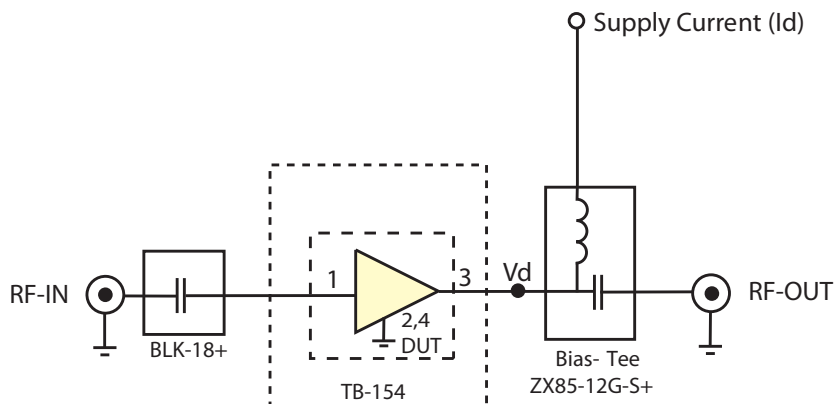
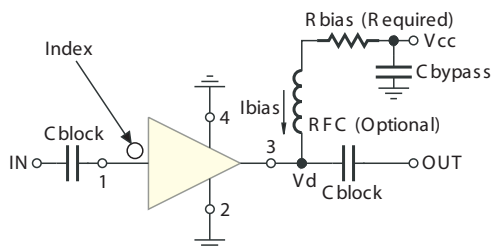

Fig 1. Block Diagram of Test Circuit used for characterization. (DUT soldered on Mini-Circuits Characterization test board TB-154) Gain, Return loss, Output power at 1dB compression (P1 dB) , output IP3 (OIP3) and noise figure measured using Agilent’s N5242A PNA-X microwave network analyzer.

Conditions:

1. Gain and Return loss: Pin= -25dBm
2. Output IP3 (OIP3): Two tones, spaced 1 MHz apart, -5 dBm/tone at output.

Recommended Application Circuit



Test Board includes case, connectors, and components (in bold) soldered to PCB

Product Marking



R BIAS	
Vcc	“1%” Res. Values (ohms) for Optimum Biasing
7	61.9
8	80.6
9	100
10	121
11	140
12	165
13	182
14	200
15	221
16	237
17	261
18	274
19	301
20	316

Notes

- A. Performance and quality attributes and conditions not expressly stated in this specification document are intended to be excluded and do not form a part of this specification document.
- B. Electrical specifications and performance data contained in this specification document are based on Mini-Circuit’s applicable established test performance criteria and measurement instructions.
- C. The parts covered by this specification document are subject to Mini-Circuits standard limited warranty and terms and conditions (collectively, “Standard Terms”); Purchasers of this part are entitled to the rights and benefits contained therein. For a full statement of the Standard Terms and the exclusive rights and remedies thereunder, please visit Mini-Circuits’ website at www.minicircuits.com/MCLStore/terms.jsp



Additional Detailed Technical Information	
<i>additional information is available on our dash board. To access this information click here</i>	
Performance Data	Data Table
	Swept Graphs
	S-Parameter (S2P Files) Data Set (.zip file)
Case Style	FG873, MCLP Plastic package, exposed paddle, lead finish: Matte-Tin
Tape & Reel	F68 7" Reels with 20, 50, 100, 200, 500, 1K devices 13" Reels with 2K, 3K, 4K devices
Suggested Layout for PCB Design	98-PL-252
Evaluation Board	TB-413-9+
Environmental Ratings	ENV08T1

ESD Rating

Human Body Model (HBM): Class 1B (500 to <1000V) in accordance with ANSI/ESD STM 5.1 - 2001

Machine Model (MM): Class M1 (25V) in accordance with ANSI/ESD STM5.2-1999

MSL Rating

Moisture Sensitivity: MSL1 in accordance with IPC/JEDEC J-STD-020D

MSL Test Flow Chart

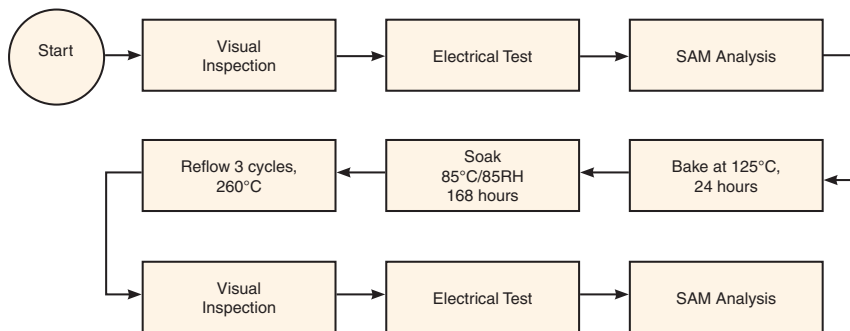



Notes

- A. Performance and quality attributes and conditions not expressly stated in this specification document are intended to be excluded and do not form a part of this specification document.
- B. Electrical specifications and performance data contained in this specification document are based on Mini-Circuit's applicable established test performance criteria and measurement instructions.
- C. The parts covered by this specification document are subject to Mini-Circuits standard limited warranty and terms and conditions (collectively, "Standard Terms"); Purchasers of this part are entitled to the rights and benefits contained therein. For a full statement of the Standard Terms and the exclusive rights and remedies thereunder, please visit Mini-Circuits' website at www.minicircuits.com/MCLStore/terms.jsp



Looking for pricing, stock, or lifecycle information?

Click below to explore more details on WIN SOURCE:

-  [View LEE-9+ on WIN SOURCE](#)
-  [Mini-Circuits Information](#)

Optimize Your Supply Chain with WIN SOURCE Solutions

-  Global Sourcing Solution
-  Obsolete Management
-  Cost Control Management
-  Shortage Management
-  Alternative Solution
-  Excess Inventory Management