



**THE DATASHEET OF  
LC4128V-10TN100I**



# IRF9321PbF

HEXFET® Power MOSFET

<b>V<sub>DS</sub></b>	<b>-30</b>	<b>V</b>
<b>R<sub>DS(on)</sub> max</b> (@ V <sub>GS</sub> = -10V)	<b>7.2</b>	<b>mΩ</b>
<b>R<sub>DS(on)</sub> max</b> (@ V <sub>GS</sub> = -4.5V)	<b>11.2</b>	<b>mΩ</b>
<b>Q<sub>g</sub> (typical)</b>	<b>34</b>	<b>nC</b>
<b>I<sub>D</sub></b> (@ T <sub>A</sub> = 25°C)	<b>-15</b>	<b>A</b>

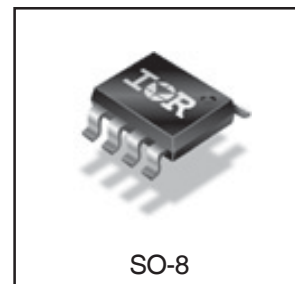
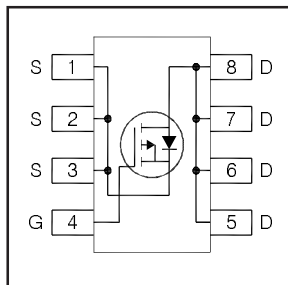

## Applications

- Charge and Discharge Switch for Notebook PC Battery Application

## Features and Benefits

### Features

Industry-Standard SO-8 Package
RoHS Compliant Containing no Lead, no Bromide and no Halogen

results in  
⇒

### Resulting Benefits

Multi-Vendor Compatibility
Environmentally Friendlier

Orderable part number	Package Type	Standard Pack		Note
		Form	Quantity	
IRF9321PbF	SO8	Tube/Bulk	95	
IRF9321TRPbF	SO8	Tape and Reel	4000	

## Absolute Maximum Ratings

	Parameter	Max.	Units
V <sub>DS</sub>	Drain-to-Source Voltage	-30	V
V <sub>GS</sub>	Gate-to-Source Voltage	±20	
I <sub>D</sub> @ T <sub>A</sub> = 25°C	Continuous Drain Current, V <sub>GS</sub> @ -10V	-15	A
I <sub>D</sub> @ T <sub>A</sub> = 70°C	Continuous Drain Current, V <sub>GS</sub> @ -10V	-12	
I <sub>DM</sub>	Pulsed Drain Current ①	-120	
P <sub>D</sub> @ T <sub>A</sub> = 25°C	Power Dissipation ④	2.5	W
P <sub>D</sub> @ T <sub>A</sub> = 70°C	Power Dissipation ④	1.6	
	Linear Derating Factor	0.02	W/°C
T <sub>J</sub>	Operating Junction and	-55 to + 150	°C
T <sub>STG</sub>	Storage Temperature Range		

Notes ① through ⑥ are on page 2

## Static @ T<sub>J</sub> = 25°C (unless otherwise specified)

	Parameter	Min.	Typ.	Max.	Units	Conditions
BV <sub>DSS</sub>	Drain-to-Source Breakdown Voltage	-30	—	—	V	V <sub>GS</sub> = 0V, I <sub>D</sub> = -250μA
ΔBV <sub>DSS</sub> /ΔT <sub>J</sub>	Breakdown Voltage Temp. Coefficient	—	0.021	—	V/°C	Reference to 25°C, I <sub>D</sub> = -1mA
R <sub>DS(on)</sub>	Static Drain-to-Source On-Resistance	—	5.9	7.2	mΩ	V <sub>GS</sub> = -10V, I <sub>D</sub> = -15A ③
		—	9.3	11.2		V <sub>GS</sub> = -4.5V, I <sub>D</sub> = -12A ③
V <sub>GS(th)</sub>	Gate Threshold Voltage	-1.3	-1.8	-2.4	V	V <sub>DS</sub> = V <sub>GS</sub> , I <sub>D</sub> = -50μA
ΔV <sub>GS(th)</sub>	Gate Threshold Voltage Coefficient	—	-5.9	—	mV/°C	
I <sub>DSS</sub>	Drain-to-Source Leakage Current	—	—	-1.0	μA	V <sub>DS</sub> = -24V, V <sub>GS</sub> = 0V
		—	—	-150		V <sub>DS</sub> = -24V, V <sub>GS</sub> = 0V, T <sub>J</sub> = 125°C
I <sub>GSS</sub>	Gate-to-Source Forward Leakage	—	—	-100	nA	V <sub>GS</sub> = -20V
	Gate-to-Source Reverse Leakage	—	—	100		V <sub>GS</sub> = 20V
g <sub>fs</sub>	Forward Transconductance	30	—	—	S	V <sub>DS</sub> = -10V, I <sub>D</sub> = -12A
Q <sub>g</sub>	Total Gate Charge ⑥	—	34	—	nC	V <sub>DS</sub> = -15V, V <sub>GS</sub> = -4.5V, I <sub>D</sub> = -12A
Q <sub>g</sub>	Total Gate Charge ⑥	—	65	98	nC	V <sub>GS</sub> = -10V
Q <sub>gs</sub>	Gate-to-Source Charge ⑥	—	10	—		V <sub>DS</sub> = -15V
Q <sub>gd</sub>	Gate-to-Drain Charge ⑥	—	16	—		I <sub>D</sub> = -12A
R <sub>G</sub>	Gate Resistance ⑥	—	18	—	Ω	
t <sub>d(on)</sub>	Turn-On Delay Time	—	21	—	ns	V <sub>DD</sub> = -30V, V <sub>GS</sub> = -4.5V ③
t <sub>r</sub>	Rise Time	—	79	—		I <sub>D</sub> = -1.0A
t <sub>d(off)</sub>	Turn-Off Delay Time	—	185	—		R <sub>G</sub> = 6.8Ω
t <sub>f</sub>	Fall Time	—	145	—		See Figs. 19a & 19b
C <sub>iss</sub>	Input Capacitance	—	2590	—		V <sub>GS</sub> = 0V
C <sub>oss</sub>	Output Capacitance	—	590	—	pF	V <sub>DS</sub> = -25V
C <sub>rss</sub>	Reverse Transfer Capacitance	—	360	—		f = 1.0MHz

## Avalanche Characteristics

	Parameter	Typ.	Max.	Units
E <sub>AS</sub>	Single Pulse Avalanche Energy ②	—	310	mJ
I <sub>AR</sub>	Avalanche Current ①	—	-12	A

## Diode Characteristics

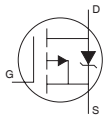
	Parameter	Min.	Typ.	Max.	Units	Conditions
I <sub>S</sub>	Continuous Source Current (Body Diode)	—	—	-2.5	A	MOSFET symbol showing the integral reverse p-n junction diode. 
I <sub>SM</sub>	Pulsed Source Current (Body Diode) ①	—	—	-120		
V <sub>SD</sub>	Diode Forward Voltage	—	—	-1.2	V	T <sub>J</sub> = 25°C, I <sub>S</sub> = -2.5A, V <sub>GS</sub> = 0V ③
t <sub>rr</sub>	Reverse Recovery Time	—	38	57	ns	T <sub>J</sub> = 25°C, I <sub>F</sub> = -2.5A, V <sub>DD</sub> = -24V
Q <sub>rr</sub>	Reverse Recovery Charge	—	24	36	nC	di/dt = 100/μs ③

## Thermal Resistance

	Parameter	Typ.	Max.	Units
R <sub>θJL</sub>	Junction-to-Drain Lead ⑤	—	20	°C/W
R <sub>θJA</sub>	Junction-to-Ambient ④	—	50	

### Notes:

- ① Repetitive rating; pulse width limited by max. junction temperature.
- ② Starting T<sub>J</sub> = 25°C, L = 4.3mH, R<sub>G</sub> = 25Ω, I<sub>AS</sub> = -12A.
- ③ Pulse width ≤ 400μs; duty cycle ≤ 2%.
- ④ When mounted on 1 inch square copper board.
- ⑤ R<sub>θ</sub> is measured at T<sub>J</sub> of approximately 90°C.
- ⑥ For DESIGN AID ONLY, not subject to production testing.

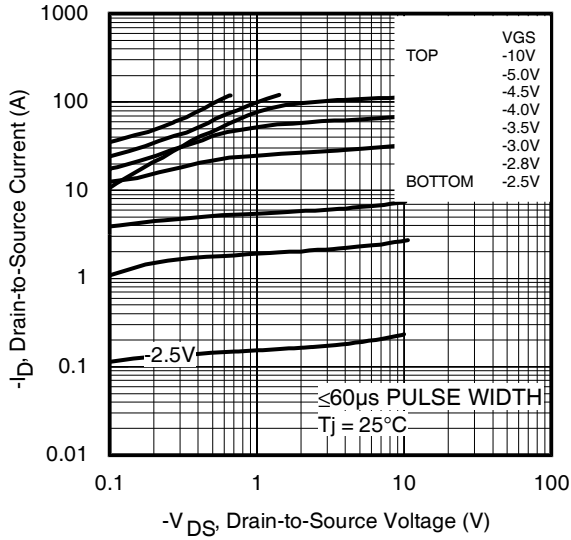

**Fig 1.** Typical Output Characteristics

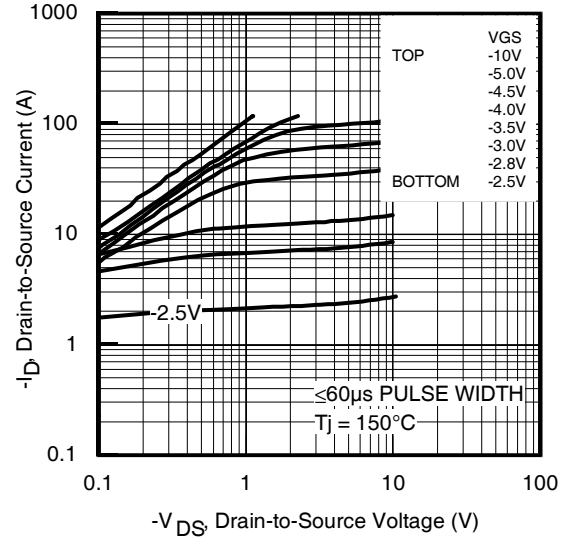

**Fig 2.** Typical Output Characteristics

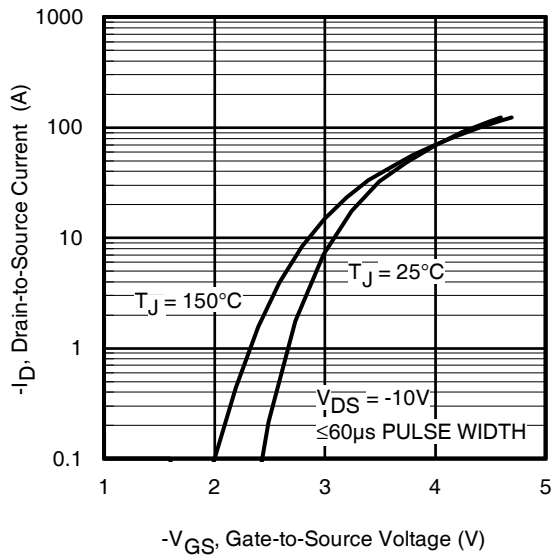

**Fig 3.** Typical Transfer Characteristics

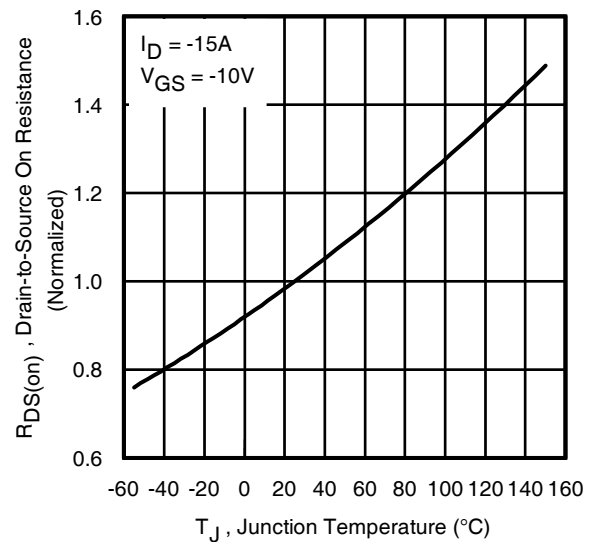

**Fig 4.** Normalized On-Resistance vs. Temperature

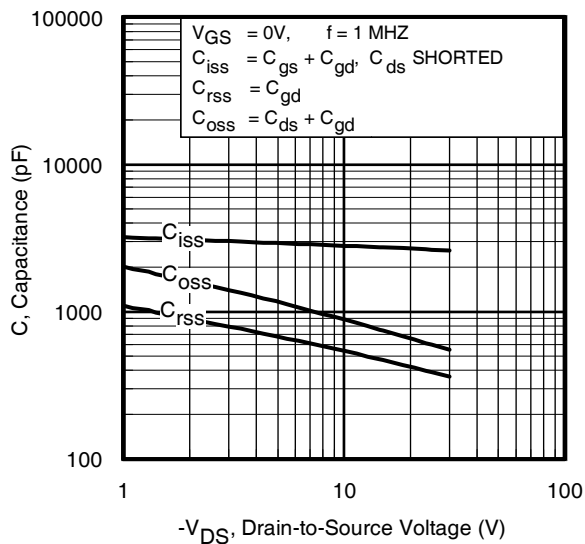

**Fig 5.** Typical Capacitance vs. Drain-to-Source Voltage  
[www.irf.com](http://www.irf.com)

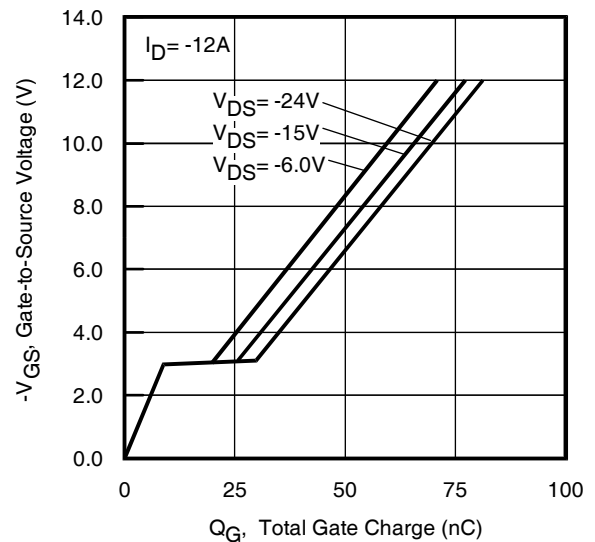

**Fig 6.** Typical Gate Charge vs. Gate-to-Source Voltage

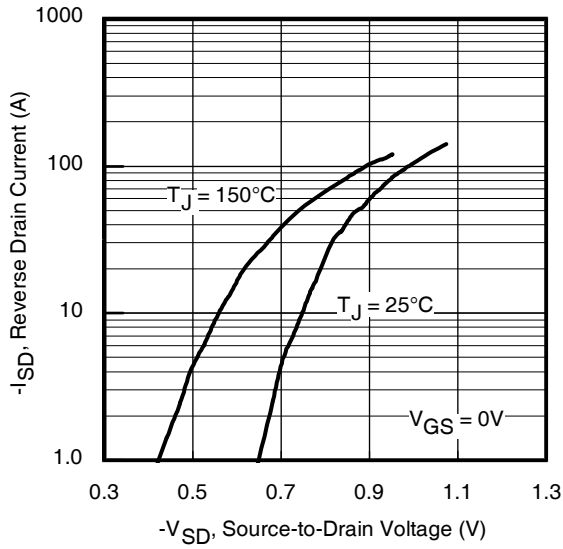

**Fig 7.** Typical Source-Drain Diode Forward Voltage

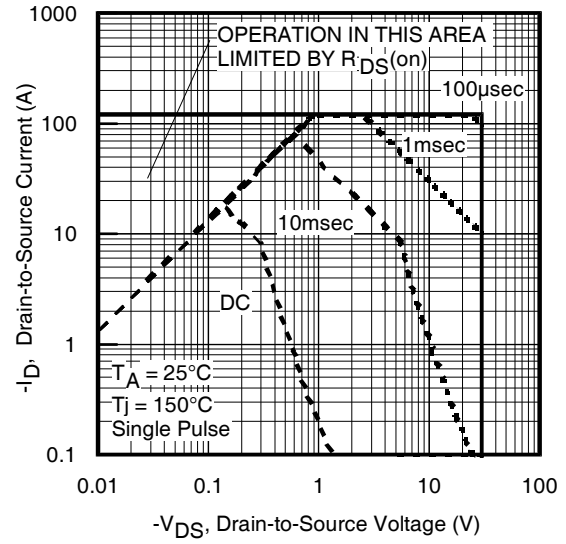

**Fig 8.** Maximum Safe Operating Area

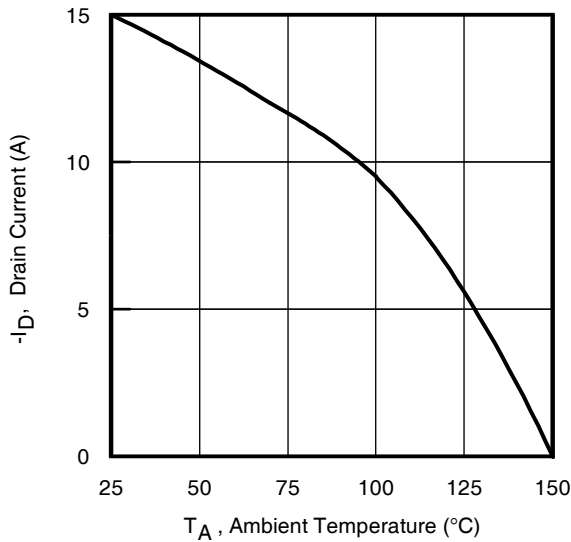

**Fig 9.** Maximum Drain Current vs. Ambient Temperature

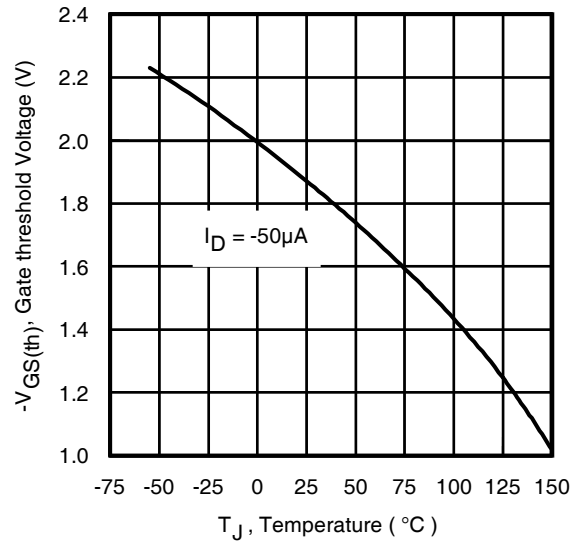

**Fig 10.** Threshold Voltage vs. Temperature

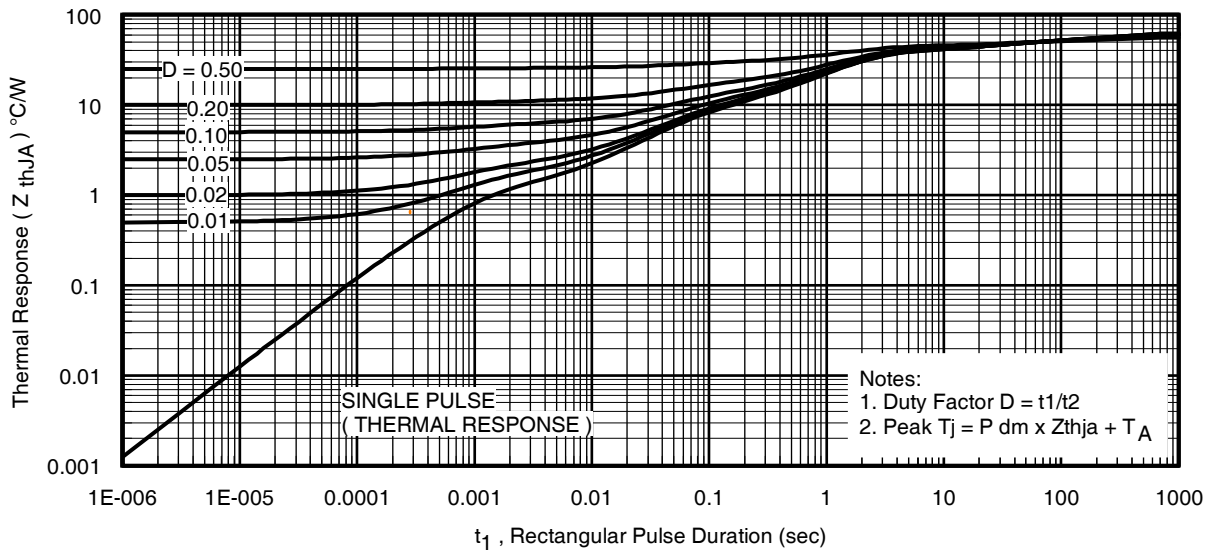

**Fig 11.** Maximum Effective Transient Thermal Impedance, Junction-to-Ambient

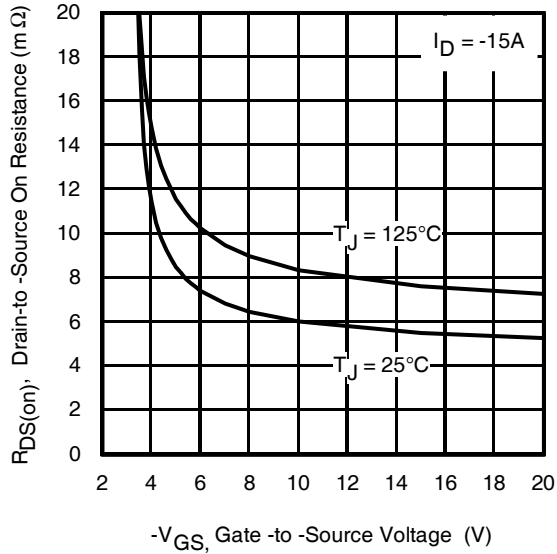

**Fig 12.** On-Resistance vs. Gate Voltage

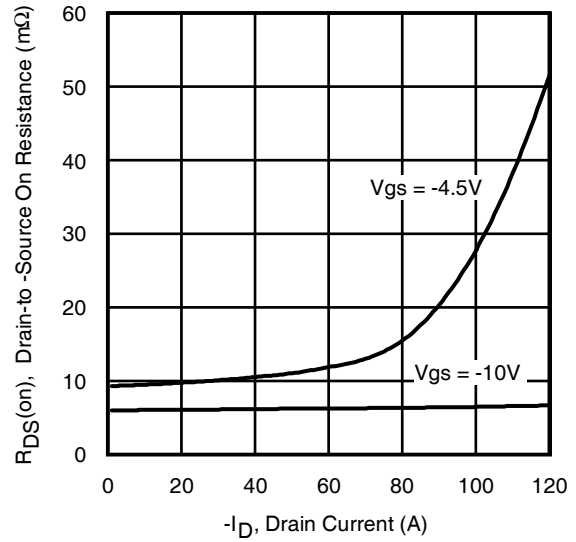

**Fig 13.** Typical On-Resistance vs. Drain Current

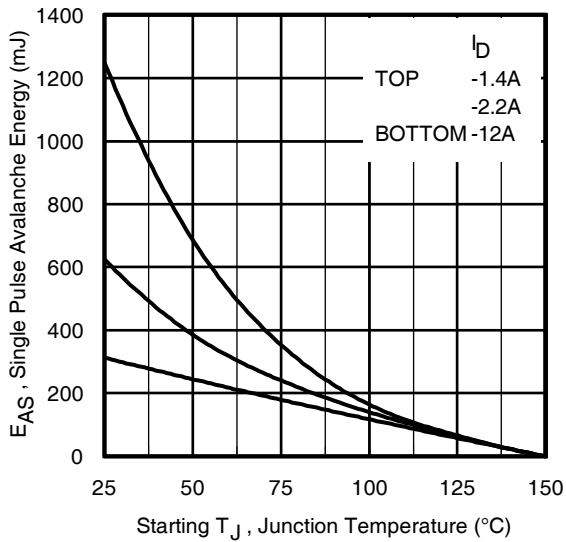

**Fig 14.** Maximum Avalanche Energy vs. Drain Current

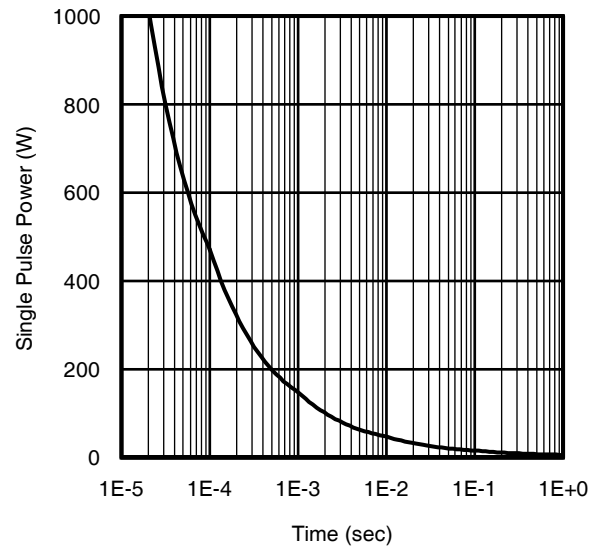

**Fig 15.** Typical Power vs. Time

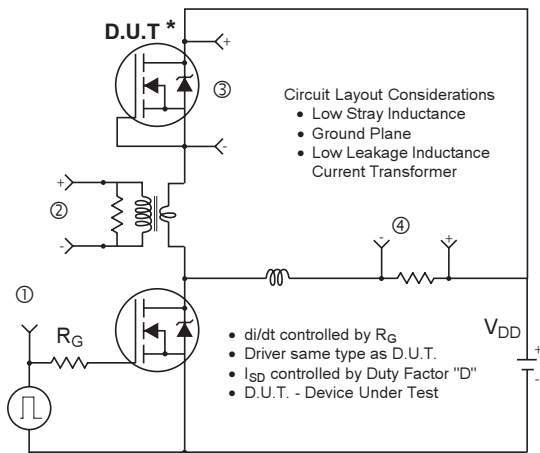

\* Reverse Polarity of D.U.T for P-Channel

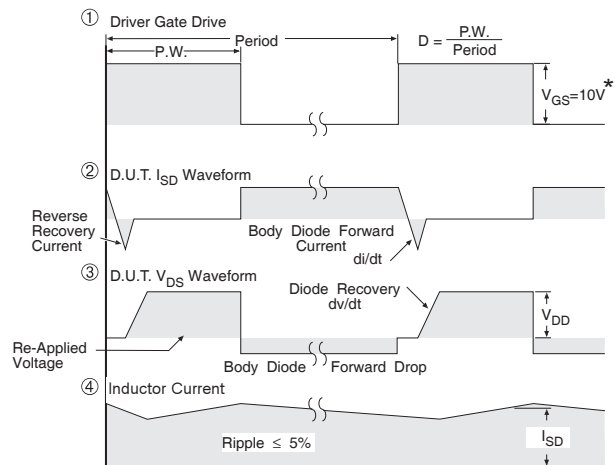

\*  $V_{GS} = 5V$  for Logic Level Devices

**Fig 16.** Diode Reverse Recovery Test Circuit for P-Channel HEXFET® Power MOSFETs

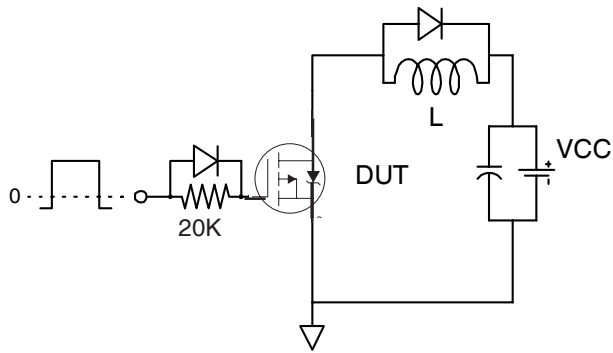

**Fig 17a.** Gate Charge Test Circuit

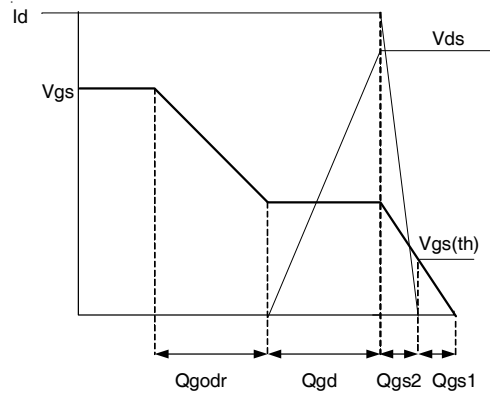

**Fig 17b.** Gate Charge Waveform

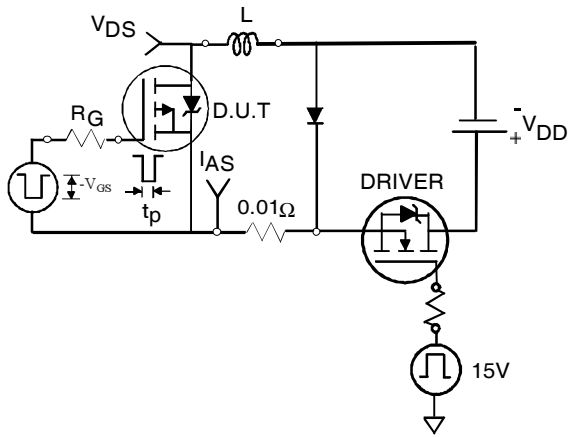

**Fig 18a.** Unclamped Inductive Test Circuit

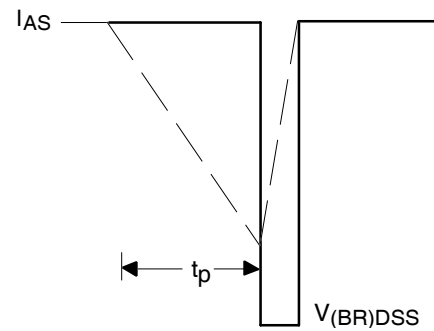

**Fig 18b.** Unclamped Inductive Waveforms

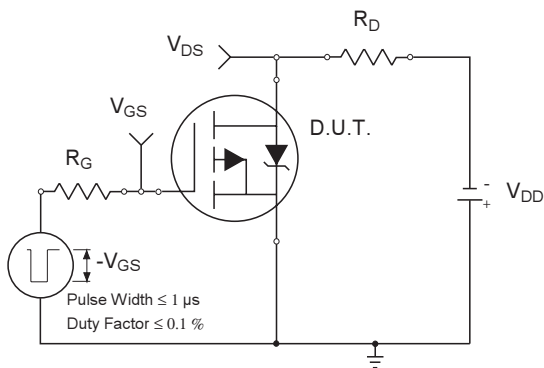

**Fig 19a.** Switching Time Test Circuit

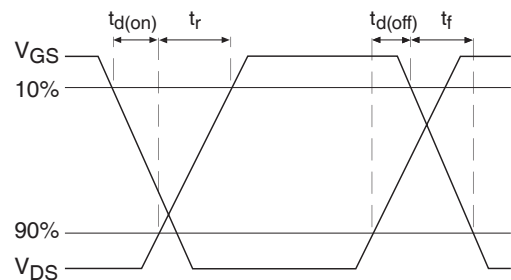

**Fig 19b.** Switching Time Waveforms

## SO-8 Package Outline (MOSFET & Fetky)

Dimensions are shown in millimeters (inches)

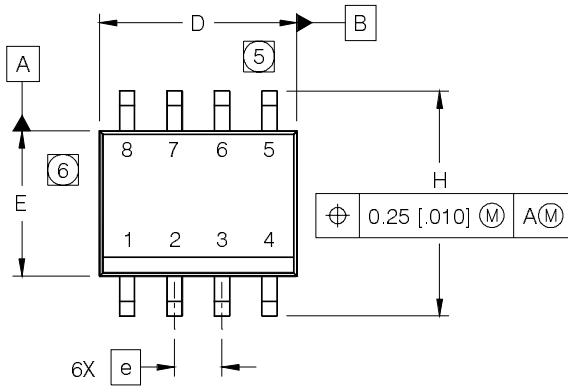

DIM	INCHES		MILLIMETERS	
	MIN	MAX	MIN	MAX
A	.0532	.0688	1.35	1.75
A1	.0040	.0098	0.10	0.25
b	.013	.020	0.33	0.51
c	.0075	.0098	0.19	0.25
D	.189	.1968	4.80	5.00
E	.1497	.1574	3.80	4.00
e	.050 BASIC		1.27 BASIC	
e 1	.025 BASIC		0.635 BASIC	
H	.2284	.2440	5.80	6.20
K	.0099	.0196	0.25	0.50
L	.016	.050	0.40	1.27
y	0°	8°	0°	8°

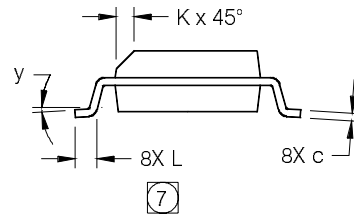
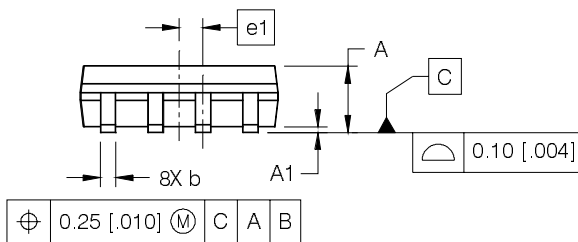

### FOOTPRINT

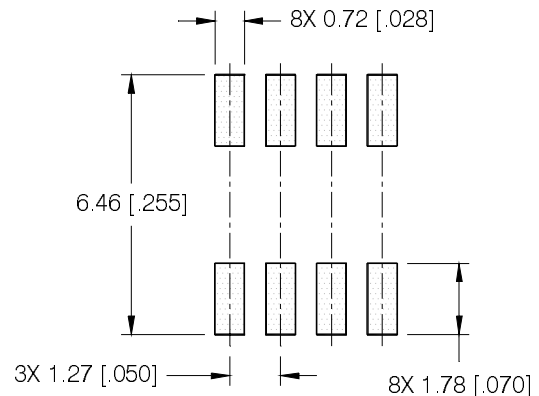

### NOTES:

- DIMENSIONING & TOLERANCING PER ASME Y14.5M-1994.
- CONTROLLING DIMENSION: MILLIMETER
- DIMENSIONS ARE SHOWN IN MILLIMETERS [INCHES].
- OUTLINE CONFORMS TO JEDEC OUTLINE MS-012AA.
- 5** DIMENSION DOES NOT INCLUDE MOLD PROTRUSIONS. MOLD PROTRUSIONS NOT TO EXCEED 0.15 [.006].
- 6** DIMENSION DOES NOT INCLUDE MOLD PROTRUSIONS. MOLD PROTRUSIONS NOT TO EXCEED 0.25 [.010].
- 7** DIMENSION IS THE LENGTH OF LEAD FOR SOLDERING TO A SUBSTRATE.

## SO-8 Part Marking Information

EXAMPLE: THIS IS AN IRF7101 (MOSFET)

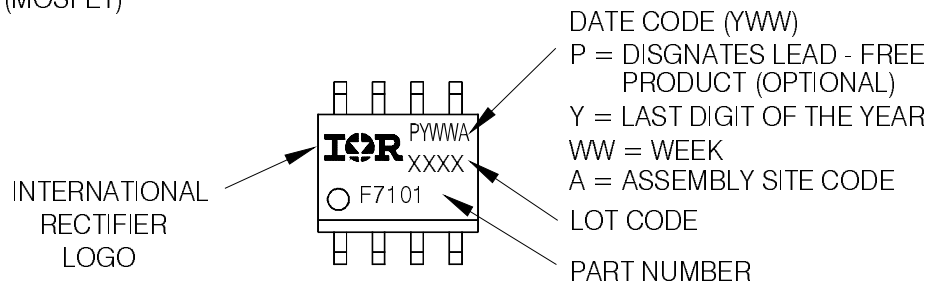

Note: For the most current drawing please refer to IR website at <http://www.irf.com/package/>

# IRF9321PbF

SO-8 Tape and Reel (Dimensions are shown in millimeters (inches))

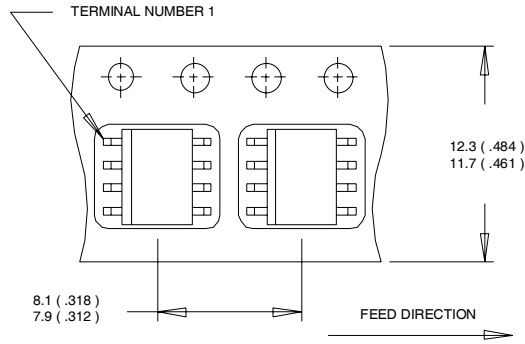

- NOTES:
1. CONTROLLING DIMENSION : MILLIMETER.
  2. ALL DIMENSIONS ARE SHOWN IN MILLIMETERS(INCHES).
  3. OUTLINE CONFORMS TO EIA-481 & EIA-541.

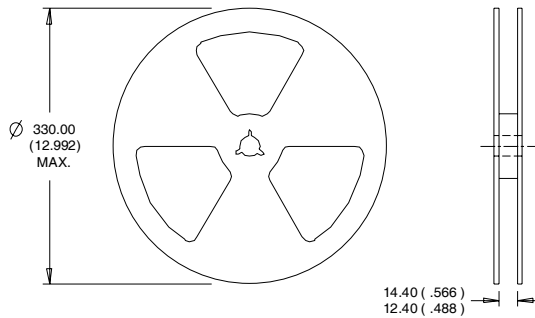

- NOTES :
1. CONTROLLING DIMENSION : MILLIMETER.
  2. OUTLINE CONFORMS TO EIA-481 & EIA-541.

## Qualification Information†

Qualification level	Consumer ††	
	(per JEDEC JESD47F††† guidelines)	
Moisture Sensitivity Level	SO-8	MSL1 (per JEDEC J-STD-020D†††)
RoHS Compliant	Yes	

† Qualification standards can be found at International Rectifier's web site  
<http://www.irf.com/product-info/reliability>

†† Higher qualification ratings may be available should the user have such requirements.  
Please contact your International Rectifier sales representative for further information:  
<http://www.irf.com/whoto-call/salesrep/>

††† Applicable version of JEDEC standard at the time of product release.

Data and specifications subject to change without notice.

## **IMPORTANT NOTICE**

The information given in this document shall in no event be regarded as a guarantee of conditions or characteristics ("Beschaffheitsgarantie").

With respect to any examples, hints or any typical values stated herein and/or any information regarding the application of the product, Infineon Technologies hereby disclaims any and all warranties and liabilities of any kind, including without limitation warranties of non-infringement of intellectual property rights of any third party.

In addition, any information given in this document is subject to customer's compliance with its obligations stated in this document and any applicable legal requirements, norms and standards concerning customer's products and any use of the product of Infineon Technologies in customer's applications.

The data contained in this document is exclusively intended for technically trained staff. It is the responsibility of customer's technical departments to evaluate the suitability of the product for the intended application and the completeness of the product information given in this document with respect to such application.

For further information on the product, technology, delivery terms and conditions and prices please contact your nearest Infineon Technologies office ([www.infineon.com](http://www.infineon.com)).

## **WARNINGS**

Due to technical requirements products may contain dangerous substances. For information on the types in question please contact your nearest Infineon Technologies office.

Except as otherwise explicitly approved by Infineon Technologies in a written document signed by authorized representatives of Infineon Technologies, Infineon Technologies' products may not be used in any applications where a failure of the product or any consequences of the use thereof can reasonably be expected to result in personal injury.

## Looking for pricing, stock, or lifecycle information?

Click below to explore more details on WIN SOURCE:

- ⊖ [View LC4128V-10TN100I on WIN SOURCE](#)
- ⊖ [Lattice Semiconductor Corporation Information](#)

## Optimize Your Supply Chain with WIN SOURCE Solutions

- ✓ Global Sourcing Solution
- ✓ Obsolete Management
- ✓ Cost Control Management
- ✓ Shortage Management
- ✓ Alternative Solution
- ✓ Excess Inventory Management