



ON Semiconductor®

<http://onsemi.com>

LB1941T

Monolithic Linear IC For Digital Cameras Constant Current Forward/Reverse Driver IC

Overview

The LB1941T is a single-channel forward/reverse driver IC that provides a constant current control function. Its low-saturation output makes it appropriate for voice coil motor control, and it is optimal for use as the shutter driver IC in digital cameras.

Functions

- Constant current control ($I_O = 400\text{mA}$ when $R_f = 0.5\Omega$)
- Ultraminiature package (MSOP8: 150mil)
- Built-in thermal protection circuit
- Includes a rapid charge/rapid discharge circuit for stable shutter operation.
- Built-in reference voltage circuit (0.2V typical)

Specifications

Absolute Maximum Ratings at $T_a = 25^\circ\text{C}$

Parameter	Symbol	Conditions	Ratings	Unit
Maximum supply voltage	V_{CC} max		-0.3 to +10.5	V
Output current	I_O max		600	mA
Output applied voltage	V_O max		-0.3 to $V_{CC}+0.3$	V
Input applied voltage	V_{IN} max	IN1, IN2	-0.3 to +10.5	V
Allowable power dissipation	P_d max	Mounted on a specified board.*	400	mW
Operating temperature	T_{opr}		-20 to +75	$^\circ\text{C}$
Storage temperature	T_{stg}		-55 to +150	$^\circ\text{C}$

Note*: Mounted on a board: 114.3mm×76.1mm×1.6mm, glass epoxy resin.

Stresses exceeding Maximum Ratings may damage the device. Maximum Ratings are stress ratings only. Functional operation above the Recommended Operating Conditions is not implied. Extended exposure to stresses above the Recommended Operating Conditions may affect device reliability.

LB1941T

Allowable Operating Range at Ta = 25°C

Parameter	Symbol	Conditions	Ratings	Unit
Function-guaranteed voltage range	VOPR		2.5 to 10	V
Constant-current set range	I _{OUT}	Set with RFG-GND resistance	50 to 500	mA
Input low level voltage	V _{IL}	IN1, IN2	-0.3 to +0.5	V
Input high level voltage	V _{IH}	IN1, IN2	2.0 to 10	V

Electrical Characteristics at Ta = 25°C

Parameter	Symbol	Conditions	Ratings			Unit
			min	typ	max	
Standby Current dissipation	I _{STB}	V _{CC} = 8.5V			1.0	μA
Constant-current H bridge drive circuit						
Output saturation voltage	V _{O(sat)1}	V _{CC} = 3V, I _O = 200mA (Upper + Lower side)		0.20	0.35	V
	V _{O(sat)2}	V _{CC} = 4V, I _O = 400mA (Upper + Lower side)		0.50	0.70	V
Output constant current	I _{OUT}	V _{CC} = 4V, R _L = 3Ω, R _F = 0.5Ω	375	400	424	mA
Temperature dependence of output constant current (reference Ta = 25°C)	ΔI _O	V _{CC} = 4V, R _L = 3Ω, R _F = 0.5Ω * (Ta = -10 to +60°C)	-2		+2	%
Operating current dissipation	I _{CC}	V _{CC} = 4V, R _L = 0Ω, (No load, full drive)		14	21	mA
Thermal protection operating temperature	TSD	Design target value *	150	180	210	°C
Control input circuit						
Control pin maximum input current	I _{IH}	V _{IH} = 5.5V, V _{CC} = 5.5V		80	100	μA
	I _{IL}	V _{IL} = GND	-1		0	μA

Note*: These items are design target values and are not tested.

Package Dimensions

unit : mm (typ)

3245B

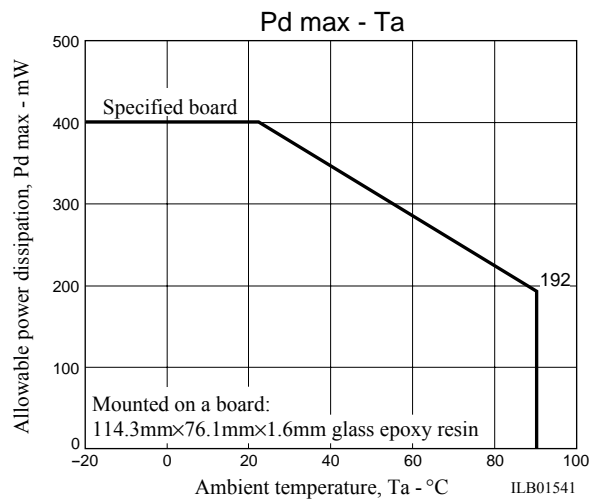
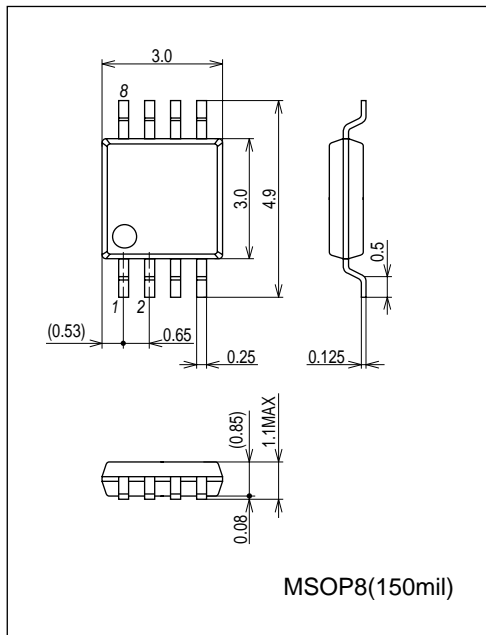

LB1941T

Pin Assignment

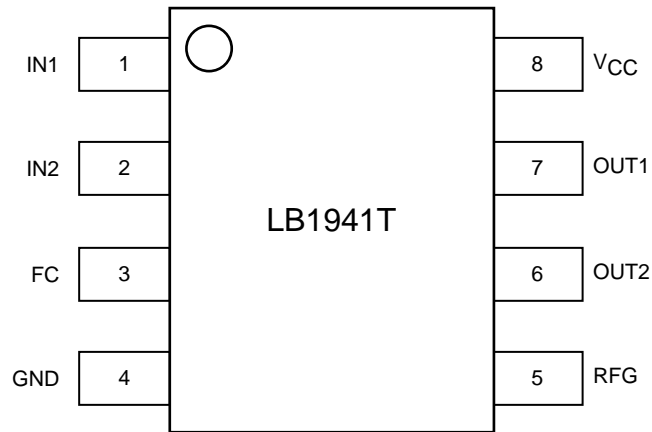

Top view

Block Diagram

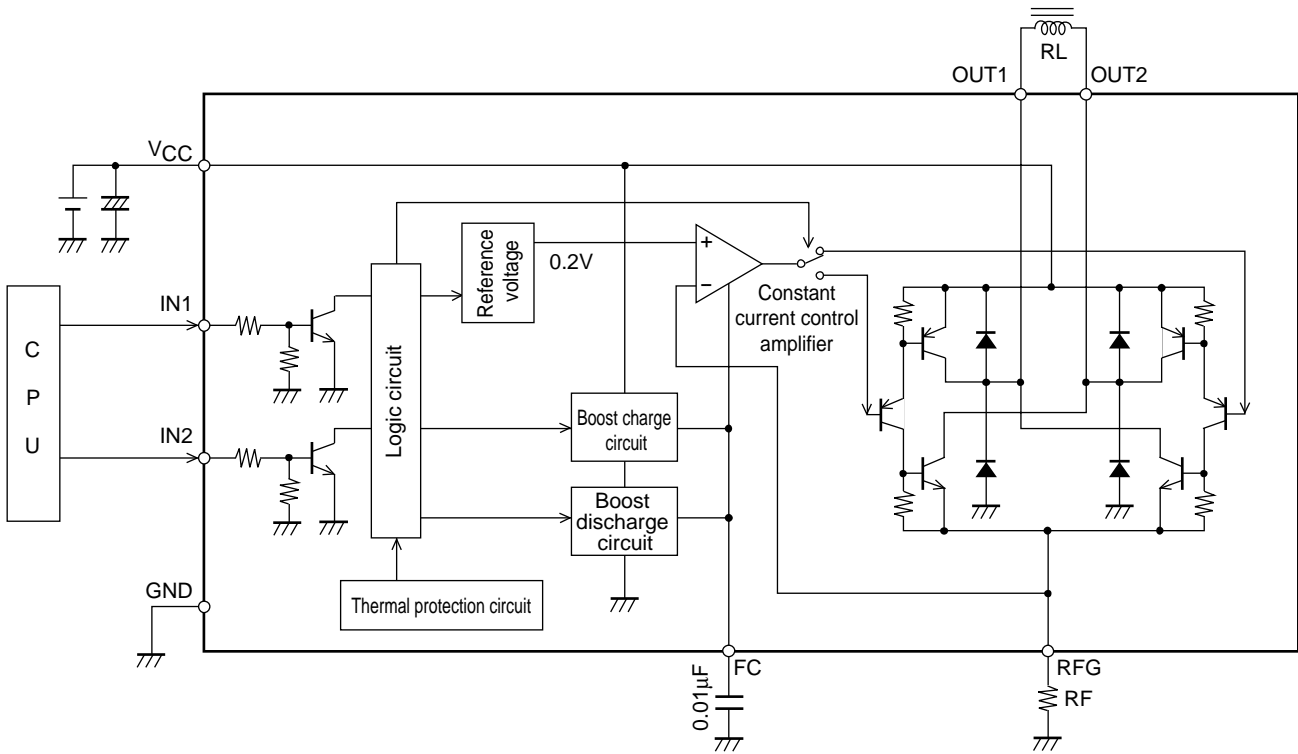

ILB01540

Boost charge and discharge circuits

In order to keep the output response time constant during mode transfer from the standby state to forward (reverse) rotation, this IC incorporates boost charge and discharge circuits for external capacitor connected to the FC pin.

The external capacitor connected to the FC pin is for output phase compensation (to suppress oscillation), for which 0.01 to 0.1 μF is recommended. Note that increase in the capacitor value results in increase in the time necessary for the constant current control to rise.

Truth Table

Input		Output		Mode
IN1	IN2	OUT1	OUT2	
L	L	OFF	OFF	Standby 1*
H	L	H	L	Forward rotation
L	H	L	H	Reverse rotation
H	H	OFF	OFF	Standby 2*

Cautions for use

Standby states 1 and 2 in the above truth table differ as follows:

Standby state 1All circuits in IC are not operating and the current dissipation is almost zero.

Standby state 2The constant-current control amplifier output in IC is in the full drive condition. Both OUT1 and OUT2 are OFF. The current dissipation is a few mA.

During mode transfer from the standby state 1 to forward (reverse) rotation, the current rises from the output current zero condition to the required constant current value. On the other hand, during mode transfer from the standby state 2 to forward (reverse) rotation, full drive is applied once to the output, then the current lowers to the required current value.

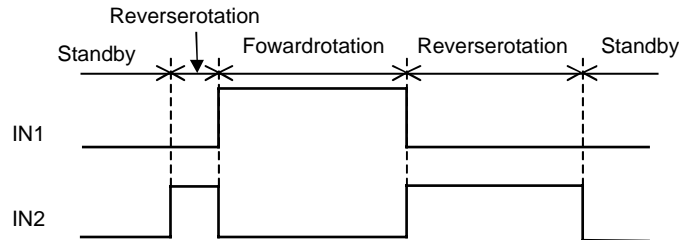

Therefore, select the standby 1 state when putting IC in the standby state. A typical drive sequence is shown in the figure below.



ON Semiconductor and the ON logo are registered trademarks of Semiconductor Components Industries, LLC (SCILLC). SCILLC owns the rights to a number of patents, trademarks, copyrights, trade secrets, and other intellectual property. A listing of SCILLC's product/patent coverage may be accessed at www.onsemi.com/site/pdf/Patent-Marking.pdf. SCILLC reserves the right to make changes without further notice to any products herein. SCILLC makes no warranty, representation or guarantee regarding the suitability of its products for any particular purpose, nor does SCILLC assume any liability arising out of the application or use of any product or circuit, and specifically disclaims any and all liability, including without limitation special, consequential or incidental damages. "Typical" parameters which may be provided in SCILLC data sheets and/or specifications can and do vary in different applications and actual performance may vary over time. All operating parameters, including "Typicals" must be validated for each customer application by customer's technical experts. SCILLC does not convey any license under its patent rights nor the rights of others. SCILLC products are not designed, intended, or authorized for use as components in systems intended for surgical implant into the body, or other applications intended to support or sustain life, or for any other application in which the failure of the SCILLC product could create a situation where personal injury or death may occur. Should Buyer purchase or use SCILLC products for any such unintended or unauthorized application, Buyer shall indemnify and hold SCILLC and its officers, employees, subsidiaries, affiliates, and distributors harmless against all claims, costs, damages, and expenses, and reasonable attorney fees arising out of, directly or indirectly, any claim of personal injury or death associated with such unintended or unauthorized use, even if such claim alleges that SCILLC was negligent regarding the design or manufacture of the part. SCILLC is an Equal Opportunity/Affirmative Action Employer. This literature is subject to all applicable copyright laws and is not for resale in any manner.

Looking for pricing, stock, or lifecycle information?

Click below to explore more details on WIN SOURCE:

-  [View LB1941T-TLM-E on WIN SOURCE](#)
-  [ON Semiconductor](#) Information

Optimize Your Supply Chain with WIN SOURCE Solutions

-  Global Sourcing Solution
-  Obsolete Management
-  Cost Control Management
-  Shortage Management
-  Alternative Solution
-  Excess Inventory Management