

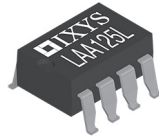

THE DATASHEET OF LAA125LSTR





Parameter	Ratings	Units
Blocking Voltage	350	V_P
Load Current	150	mA_{rms} / mA_{DC}
On-Resistance (max)	18	Ω

Features

- Current Limiting
- 3750V_{rms} Input/Output Isolation
- Low Drive Power Requirements
- High Reliability
- Arc-Free With No Snubbing Circuits
- No EMI/RFI Generation
- Small 8 Pin Packages
- Surface Mount and Tape & Reel Versions Available
- Flammability Rating UL 94 V-0

Applications

- Telecommunications
 - Telecom Switching
 - Tip/Ring Circuits
 - Modem Switching (Laptop, Notebook, Pocket Size)
 - Hook Switch
 - Dial Pulsing
 - Ground Start
 - Ringing Injection
- Instrumentation
- Multiplexers
- Data Acquisition
- Electronic Switching
- I/O Subsystems
- Medical Equipment-Patient/Equipment Isolation
- Meters (Watt-Hour, Water, Gas)
- Security
- Aerospace
- Industrial Controls

Description

LAA125L is a dual normally open (1-Form-A) Solid State Relay that has two independently controlled, optically coupled MOSFET switches with an additional current limiting circuit. The optically coupled combination of MOSFET switches and photovoltaic die provide 3750V_{rms} of input/output isolation.

The optically coupled outputs, which use patented OptoMOS architecture, are controlled by a highly efficient infrared LED.

This dual switch OptoMOS relay provides a more compact design solution than discrete single-pole relays in a variety of applications, and saves board space by incorporating both switches in a single 8-Pin package.

Approvals

- UL Recognized Component: File # E76270
- CSA Certified Component: Certificate #1175739
- EN/IEC 60950-1 Certified Component:
Certificate available on our website

Ordering Information

Part #	Description
LAA125L	8 Pin DIP (50/Tube)
LAA125LS	8 Pin Surface Mount (50/Tube)
LAA125LSTR	8 Pin Surface Mount (1,000/Reel)
LAA125PL	8 Pin Flat Pack (50/Tube)
LAA125PLTR	8 Pin Flat Pack (1,000/Reel)

Pin Configuration

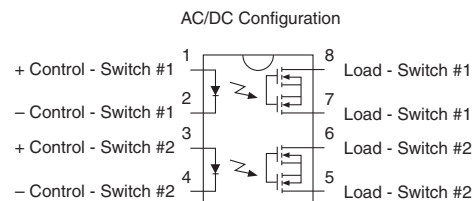

Switching Characteristics of Normally Open (Form A) Devices

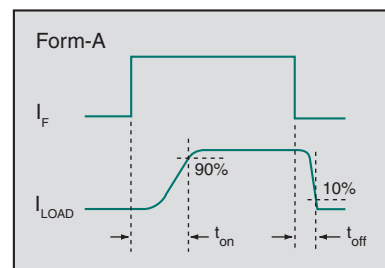

Absolute Maximum Ratings @25°C

Parameter	Ratings	Units
Blocking Voltage	350	V _P
Reverse Input Voltage	5	V
Input Control Current	50	mA
Peak (10ms)	1	A
Input Power Dissipation ¹	150	mW
Total Power Dissipation ²	800	mW
Isolation Voltage, Input to Output	3750	V _{rms}
Operational Temperature	-40 to +85	°C
Storage Temperature	-40 to +125	°C

¹ Derate linearly 1.33 mW / °C

² Derate linearly 6.67 mW / °C

Absolute Maximum Ratings are stress ratings. Stresses in excess of these ratings can cause permanent damage to the device. Functional operation of the device at conditions beyond those indicated in the operational sections of this data sheet is not implied.

Typical values are characteristic of the device at +25°C, and are the result of engineering evaluations. They are provided for information purposes only, and are not part of the manufacturing testing requirements.

Electrical Characteristics @25°C (Unless Otherwise Noted)

Parameter	Conditions	Symbol	Min	Typ	Max	Units
Output Characteristics						
Load Current, Continuous ¹	-	I _L	-	-	150	mA _{rms} / mA _{DC}
Peak Load Current	10ms max	I _{LPK}	-	-	±400	mA _P
Load Current Limiting	-	I _{CL}	±190	±235	±280	mA
On-Resistance ²	I _L =Load Current	R _{ON}	-	-	18	Ω
Off-State Leakage Current	V _L =350V _P	I _{LEAK}	-	-	1	μA
Switching Speeds						
Turn-On	I _F =5mA, V _L =10V	t _{on}	-	-	5	ms
Turn-Off		t _{off}	-	-	5	
Output Capacitance	I _F =0mA, V _L =50V, f=1MHz	C _{OUT}	-	50	-	pF
Input Characteristics						
Input Control Current to Activate	I _L =170mA	I _F	-	-	5	mA
Input Control Current to Deactivate	-	-	0.4	0.7	-	mA
Input Voltage Drop	I _F =5mA	V _F	0.9	1.2	1.5	V
Reverse Input Current	V _R =5V	I _R	-	-	10	μA
Input to Output Capacitance	V _{IO} =0V, f=1MHz	C _{IO}	-	3	-	pF

¹ If both poles operate, then the load current must be derated so that it does not exceed the package power dissipation value.

² Measurement taken within one second of on-time.

PERFORMANCE DATA*

Typical LED Forward Voltage Drop
(N=50, $I_F=5mA$)

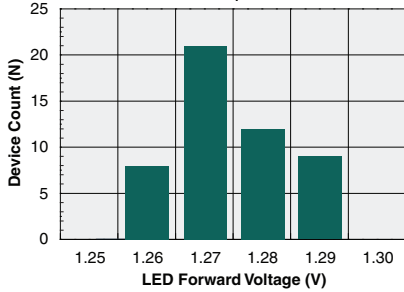

Typical Turn-On Time
(N=50, $I_F=5mA, I_L=150mA$)

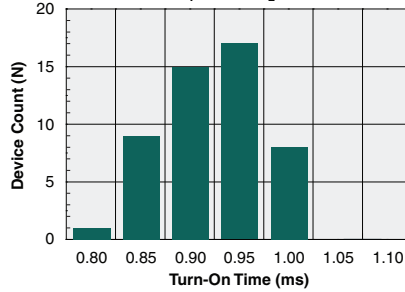

Typical Turn-Off Time
(N=50, $I_F=5mA, I_L=150mA$)

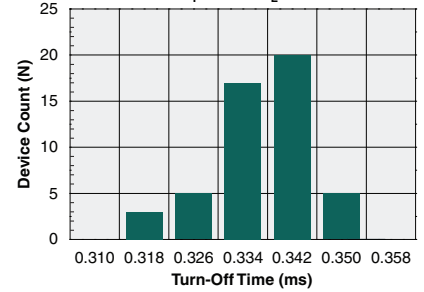

Typical I_F for Switch Operation
(N=50, $I_L=150mA$)

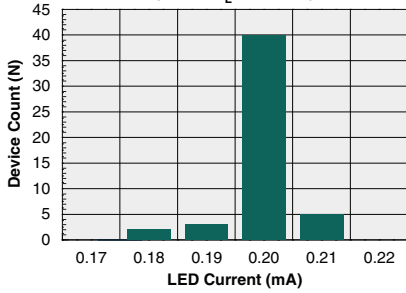

Typical On-Resistance Distribution
(N=50, $I_F=5mA, I_L=150mA$)

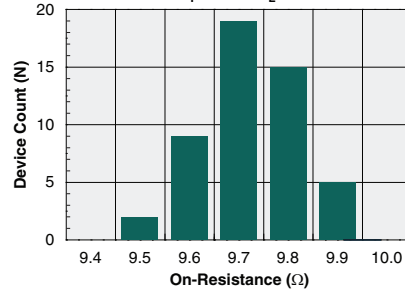

Typical Blocking Voltage Distribution
(N=50)

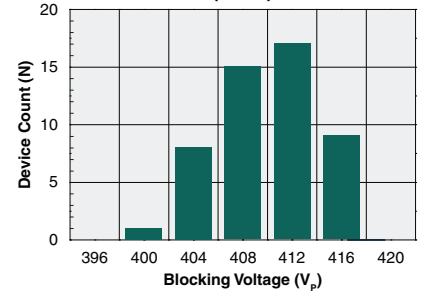

Typical LED Forward Voltage Drop
vs. Temperature

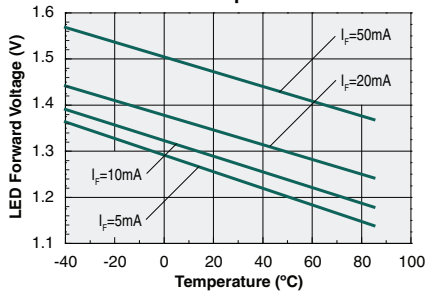

Typical Turn-On Time
vs. LED Forward Current

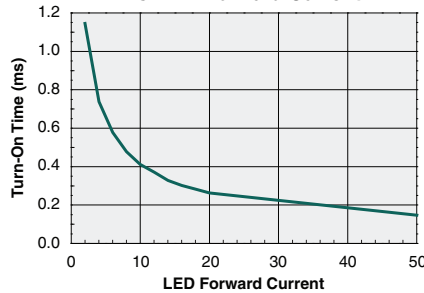

Typical Turn-Off Time
vs. LED Forward Current

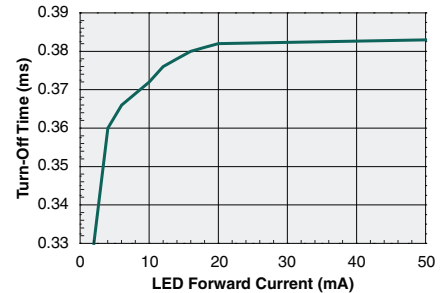

Typical I_F for Switch Operation
vs. Temperature
($I_L=80mA$)

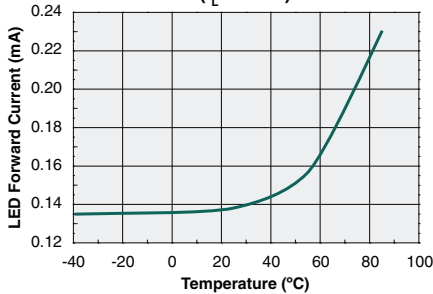

Typical Turn-On Time
vs. Temperature
($I_F=5mA, I_L=80mA$)

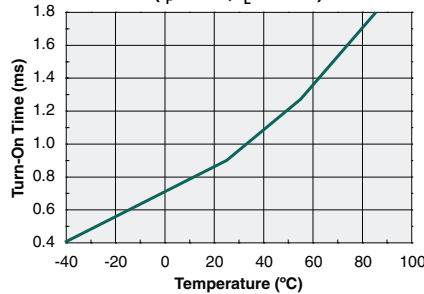

Typical Turn-Off Time
vs. Temperature
($I_F=5mA, I_L=80mA$)

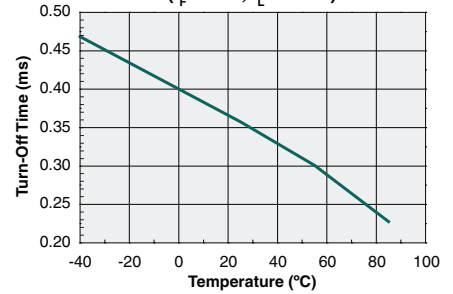

*Unless otherwise noted, data presented in these graphs is typical of device operation at 25°C.

For guaranteed parameters not indicated in the written specifications, please contact our application department.

PERFORMANCE DATA*

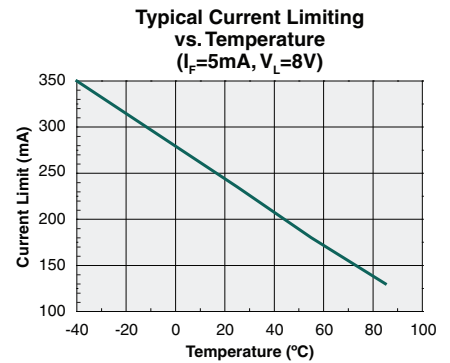
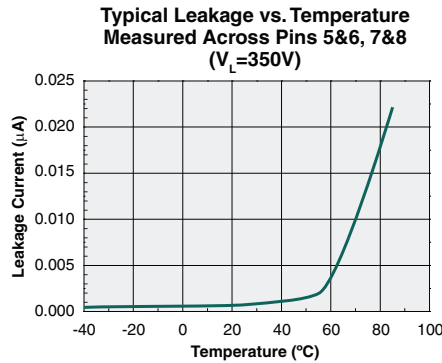
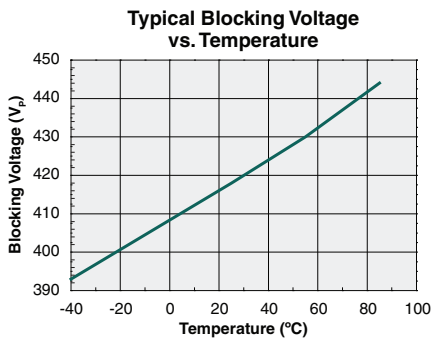
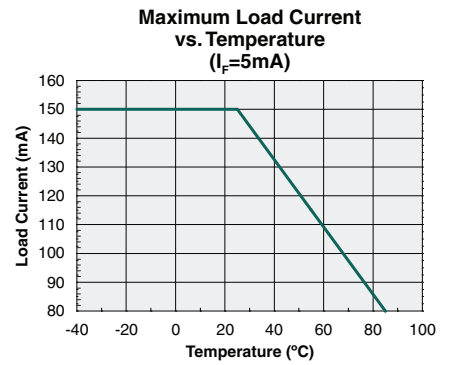
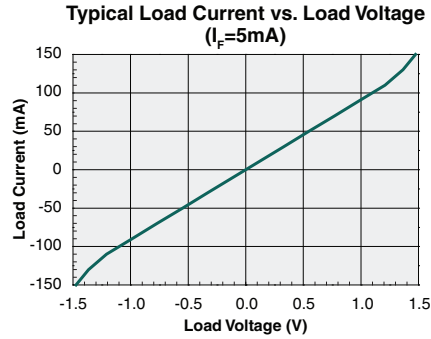
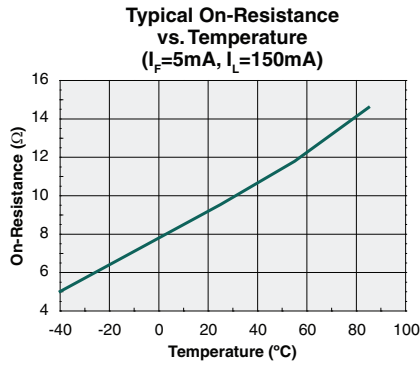

*Unless otherwise noted, data presented in these graphs is typical of device operation at 25 $^{\circ}\text{C}$.
For guaranteed parameters not indicated in the written specifications, please contact our application department.

Manufacturing Information

Moisture Sensitivity

 All plastic encapsulated semiconductor packages are susceptible to moisture ingress. IXYS Integrated Circuits classifies its plastic encapsulated devices for moisture sensitivity according to the latest version of the joint industry standard, **IPC/JEDEC J-STD-020**, in force at the time of product evaluation. We test all of our products to the maximum conditions set forth in the standard, and guarantee proper operation of our devices when handled according to the limitations and information in that standard as well as to any limitations set forth in the information or standards referenced below.

Failure to adhere to the warnings or limitations as established by the listed specifications could result in reduced product performance, reduction of operable life, and/or reduction of overall reliability.

This product carries a Moisture Sensitivity Level (MSL) classification as shown below, and should be handled according to the requirements of the latest version of the joint industry standard **IPC/JEDEC J-STD-033**.

Device	Moisture Sensitivity Level (MSL) Classification
LAA125L / LAA125LS / LAA125PL	MSL 1

ESD Sensitivity

 This product is **ESD Sensitive**, and should be handled according to the industry standard **JESD-625**.

Soldering Profile

Provided in the table below is the Classification Temperature (T_C) of this product and the maximum dwell time the body temperature of this device may be ($T_C - 5$)°C or greater. The classification temperature sets the Maximum Body Temperature allowed for this device during lead-free reflow processes. For through-hole devices, and any other processes, the guidelines of **J-STD-020** must be observed.

Device	Classification Temperature (T_C)	Dwell Time (t_p)	Max Reflow Cycles
LAA125L	250°C	30 seconds	1
LAA125LS	250°C	30 seconds	3
LAA125PL	260°C	30 seconds	3

Board Wash

IXYS Integrated Circuits recommends the use of no-clean flux formulations. Board washing to reduce or remove flux residue following the solder reflow process is acceptable provided proper precautions are taken to prevent damage to the device. These precautions include, but are not limited to: using a low pressure wash and providing a follow up bake cycle sufficient to remove any moisture trapped within the device due to the washing process. Due to the variability of the wash parameters used to clean the board, determination of the bake temperature and duration necessary to remove the moisture trapped within the package is the responsibility of the user (assembler). Cleaning or drying methods that employ ultrasonic energy may damage the device and should not be used. Additionally, the device must not be exposed to flux or solvents that are Chlorine- or Fluorine-based.



MECHANICAL DIMENSIONS

LAA125L

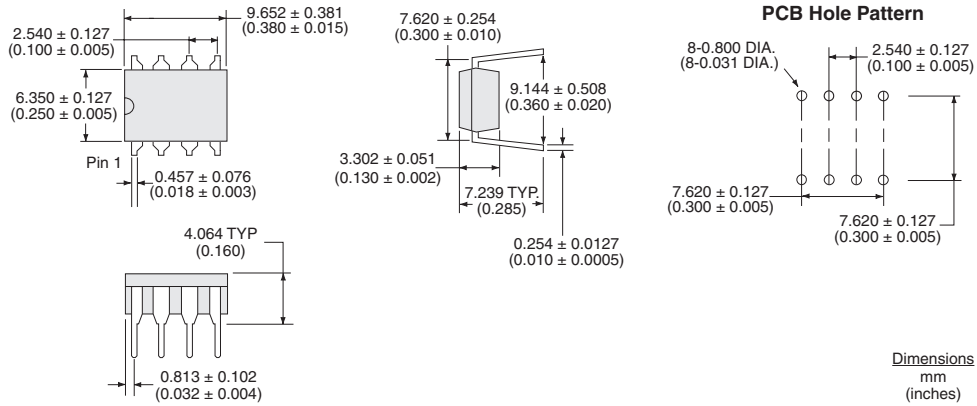

LAA125LS

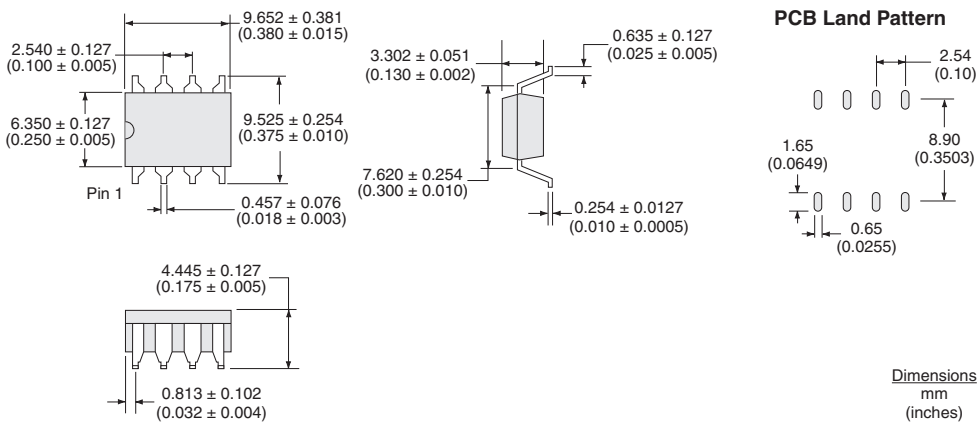

LAA125PL

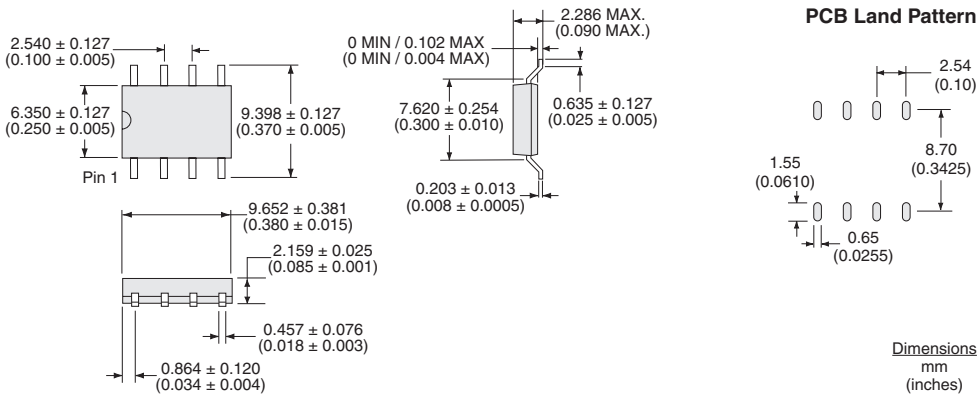

MECHANICAL DIMENSIONS

LAA125LSTR Tape & Reel

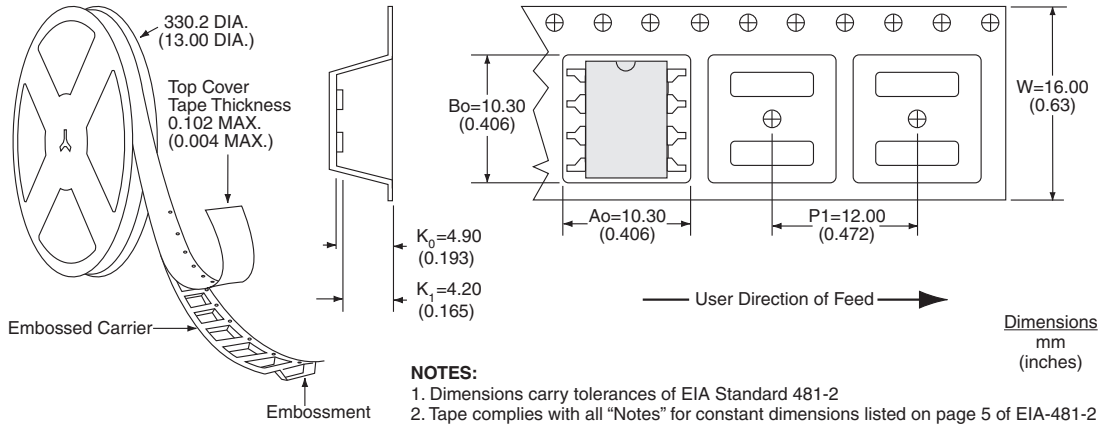

LAA125PLTR Tape & Reel

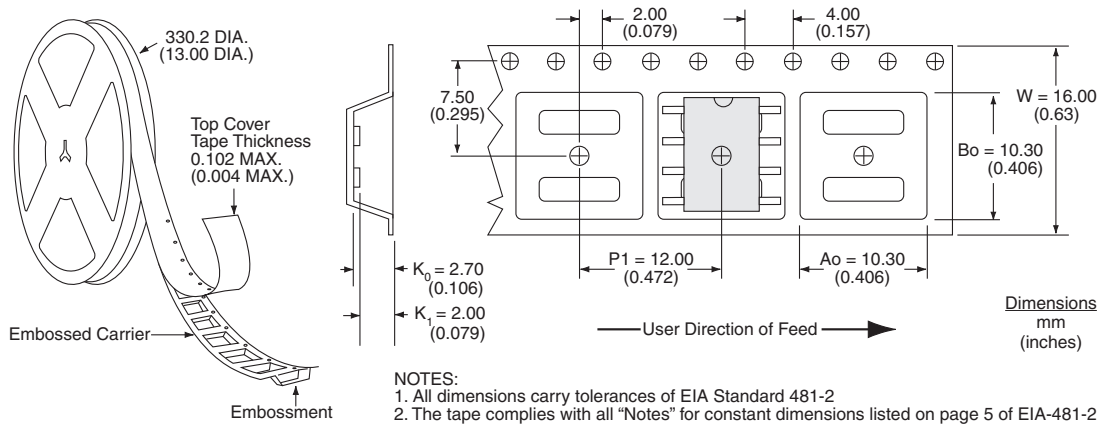

For additional information please visit our website at: www.ixysic.com

IXYS Integrated Circuits makes no representations or warranties with respect to the accuracy or completeness of the contents of this publication and reserves the right to make changes to specifications and product descriptions at any time without notice. Neither circuit patent licenses nor indemnity are expressed or implied. Except as set forth in IXYS Integrated Circuits' Standard Terms and Conditions of Sale, IXYS Integrated Circuits assumes no liability whatsoever, and disclaims any express or implied warranty, relating to its products including, but not limited to, the implied warranty of merchantability, fitness for a particular purpose, or infringement of any intellectual property right.

The products described in this document are not designed, intended, authorized or warranted for use as components in systems intended for surgical implant into the body, or in other applications intended to support or sustain life, or where malfunction of IXYS Integrated Circuits' product may result in direct physical harm, injury, or death to a person or severe property or environmental damage. IXYS Integrated Circuits reserves the right to discontinue or make changes to its products at any time without notice.

Looking for pricing, stock, or lifecycle information?

Click below to explore more details on WIN SOURCE:

 [View LAA125LSTR on WIN SOURCE](#)

 [IXYS Information](#)

Optimize Your Supply Chain with WIN SOURCE Solutions

-  Global Sourcing Solution
-  Obsolete Management
-  Cost Control Management
-  Shortage Management
-  Alternative Solution
-  Excess Inventory Management