



ON Semiconductor®

<http://onsemi.com>

# LA4628

Monolithic Linear IC

## 20W 2-Channel BTL Power Amplifier for General Audio

### Overview

The LA4628 is a 2-channel general-purpose BTL audio power amplifier provided in a miniature package. It was designed for the best possible audio quality and features an extended low band roll-off frequency provided by a newly-developed NF circuit that does not require an external capacitor. Furthermore, crosstalk, which can cause muddiness in the audio output, has been significantly reduced by both circuit and wiring pattern improvements. Thus this amplifier can provide powerful lows and clear highs.

Note that this device is pin compatible with the 13.5W×2-channel LA4625, and allows end products differentiated by their power rating to share the same printed circuit board.

### Features

- Total output : 20W+20W (at  $V_{CC} = 13.5V$ ,  $R_L = 4\Omega$ , THD = 10%)
- High-fidelity design ( $f_L < 10Hz$ ,  $f_H = 130kHz$ )
- Extremely low impulse noise levels
- An arbitrary amplifier startup time can be set up with external components.
- Full complement of built-in protection circuits (includes circuits that protect against shorting to  $V_{CC}$ , shorting to ground, load shorting, overvoltages and excessive temperatures)

### Specifications

#### Maximum Ratings at $T_a = 25^\circ C$

Parameter	Symbol	Conditions	Ratings	Unit
Maximum supply voltage	$V_{CC}$ max	No signal	24	V
Maximum output current	$I_O$ peak	Per channel	4	A
Allowable power dissipation	$P_d$ max	With an arbitrarily large heat sink	32.5	W
Operating temperature	$T_{opr}$		-20 to +85	$^\circ C$
Storage temperature	$T_{stg}$		-40 to +150	$^\circ C$

Stresses exceeding Maximum Ratings may damage the device. Maximum Ratings are stress ratings only. Functional operation above the Recommended Operating Conditions is not implied. Extended exposure to stresses above the Recommended Operating Conditions may affect device reliability.

# LA4628

## Operating Conditions at $T_a = 25^\circ\text{C}$

Parameter	Symbol	Conditions	Ratings	Unit
Recommended supply voltage	$V_{CC}$		13.5	V
Recommended load resistance range	$R_L$ op		4 to 8	$\Omega$
Allowable operating supply voltage range	$V_{CC}$ op		9 to 20	V

Note : With  $V_{CC}$ ,  $R_L$ , and the output level in ranges such that the  $P_d$  max for the heat sink used is not exceeded.

## Electrical Characteristics at $T_a = 25^\circ\text{C}$ , $V_{CC} = 13.5\text{V}$ , $R_L = 4\Omega$ , $f = 1\text{kHz}$ , $R_g = 600\Omega$

Parameter	Symbol	Conditions	Ratings			Unit
			min	typ	max	
Quiescent current	$I_{CCO}$	With $R_g = 0$ and $R_L$ open.	70	130	250	mA
Standby mode current drain	$I_{st}$	Standby mode (amplifier off), with no power supply capacitor.		10	60	$\mu\text{A}$
Voltage gain	$V_G$	$V_O = 0\text{dBm}$	38	40	42	dB
Total harmonic distortion	THD	$P_O = 1\text{W}$ , Filter = FLAT		0.06	0.2	%
Output power	$P_{O1}$	$V_{CC} = 13.5\text{V}$ , THD = 10%, $R_L = 4\Omega$	16	20		W
	$P_{O2}$	$V_{CC} = 16.5\text{V}$ , THD = 10%, $R_L = 4\Omega$		30		W
Output offset voltage	$V_N$ offset	$R_g = 0$	-300		+300	mV
Output noise voltage	$V_{NO}$	$R_g = 0$ , BPF = 20Hz to 20kHz		0.1	0.5	mV
Ripple rejection ratio	SVRR	$R_g = 0$ , $V_R = 0\text{dBm}$ , $f_R = 100\text{Hz}$	40	50		dB
Channel separation	CHsep	$R_g = 10\text{k}\Omega$ , $V_O = 0\text{dBm}$	50	60		dB
Input resistance	$R_i$		21	30	39	$\text{K}\Omega$
Standby pin applied voltage	$V_{ST}$	Amplifier on (applied through an external $10\text{k}\Omega$ resistor)	2.5		$V_{CC}$	V

## Package Dimensions

unit : mm (typ)

3113B

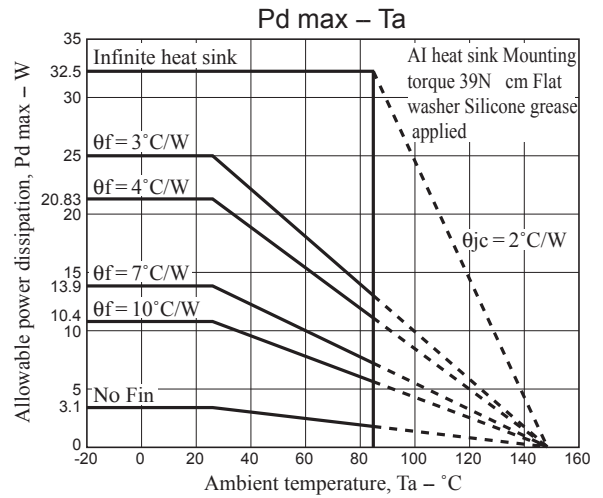
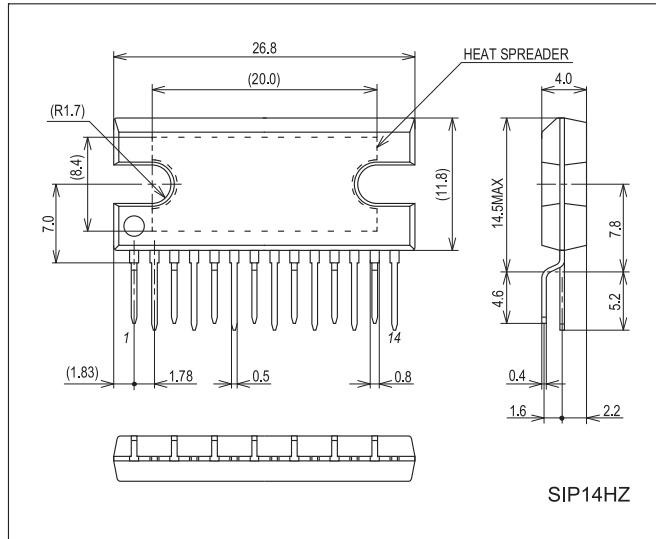

Block Diagram

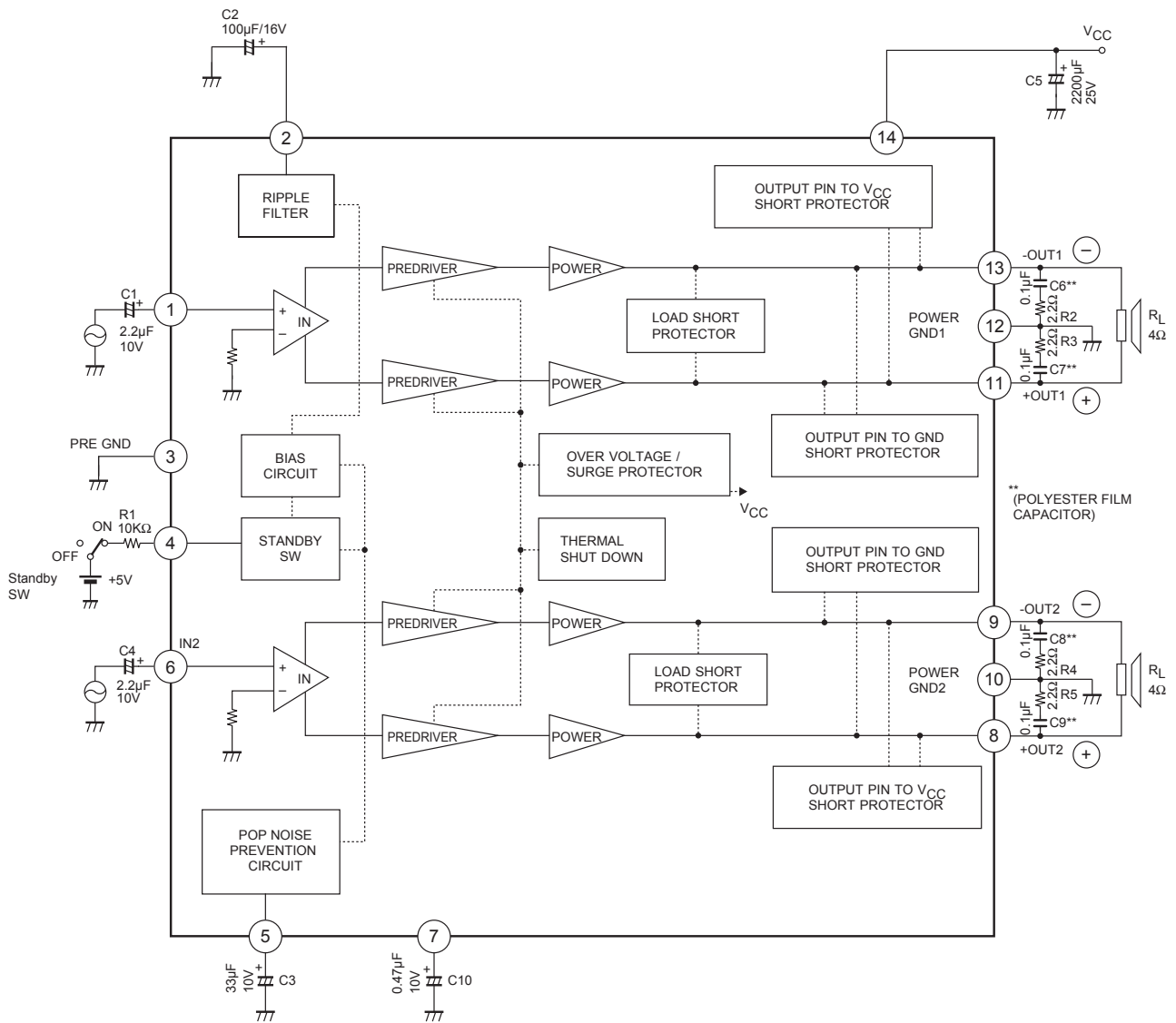

**C3**  
Sets the amplifier starting time  
(Approximately 0.6 seconds when 33µF)

**C10**  
Impulse noise reduction  
(Note : The device's ability to withstand shorting to V<sub>CC</sub> or shorting to ground when V<sub>CC</sub> is around 16V may be reduced as the value of this capacitor is increased. We recommend 0.47µF.)

### Pin Voltages

$V_{CC} = 13.5V$ , with 5V applied to STBY through a 10kΩ resistor,  $R_L = 4\Omega$ ,  $R_g = 0$

Pin No.	1	2	3	4	5	6	7
Pin name	IN1	DC	PRE-GND	STBY	ON TIME	IN2	POP
Pin voltage	1.55V	6.63V	0V	3.21V	2.32V	1.55V	2.07V

Pin No.	8	9	10	11	12	13	14
Pin name	+OUT2	-OUT2	PWR-GND	+OUT1	PWR-GND	-OUT1	$V_{CC}$
Pin voltage	6.6V	6.5V	0V	6.5V	0V	6.6V	13.5V

### External Components

- C1 and C4 : Input capacitors. A value of 2.2μF is recommended. Determine the polarity based on the DC potential of the circuit connected directly to the LA4628 front end. Note that the low band response can be adjusted by varying  $f_L$  with the capacitors C1 and C4.
- C2 : Decoupling capacitor (ripple filter)
- C3 : Sets the amplifier starting time, which will be approximately 0.6 seconds for a value of 33μF. The starting time is proportional to the value of this capacitor, and can be set to any desired value.
- C5 : Power-supply capacitor
- C6, C7, C8, and C9 : Oscillation prevention capacitors. Use polyester film capacitors (Mylar capacitors) with excellent characteristics. (Note that the series resistors R2, R3, R4, and R5 are used in conjunction with these capacitors to achieve stable amplifier operation.) A value of 0.1μF is recommended.
- C10 : Impulse noise reduction capacitor. A value of 0.47μF is recommended. Caution is required when selecting the value for this capacitor, since increasing its value influences the operation of the circuits that protect against shorting the amplifier output pins to  $V_{CC}$  or to ground when higher  $V_{CC}$  voltages (approximately 16V or higher) are used.
- R1 : Standby switch current limiting resistor. A value of 10kΩ is recommended when a voltage in the range 2.5 to 13.5V will be applied as the standby switching voltage. Note that this resistor is not optional : it must be included.

### IC Internal Characteristics and Notes

#### 1. Standby function

- Pin 4 is the standby switch. A voltage of 2.5V or higher must be applied through an external resistor to turn the amplifier on.
- If a voltage of over 13.5V will be applied as the standby mode switching voltage, use the following formula to determine the value of R1 so that the current entering at pin 4 remains under 500μA.

$$R1 = \frac{\langle \text{applied voltage} \rangle - 1.4}{500\mu A} - 10k\Omega$$

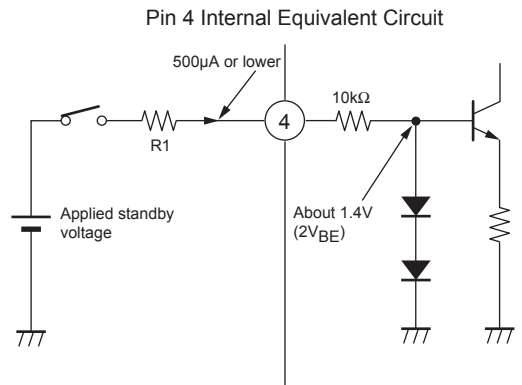

#### 2. Muting function

- Pin 5 connects the capacitor that determines the starting time to prevent impulse noise. It can also be used to mute the amplifier output by shorting pin 5 to ground. When this function is used, the recovery time depends on C3.

### 3. Impulse noise improvements

- While the LA4628 achieves a low level of impulse noise, if even further reductions in impulse noise at power on/off (and when switching into or out of standby mode) a 0.47 $\mu$ F capacitor may be inserted between pin 7 and the PRE GND pin (pin 3). (Pin 7 is the output amplifier bias pin. Since the ability to withstand shorting the output pins to V<sub>CC</sub> or ground is reduced for supply voltages over 16V if the pin 7 capacitance is large, we recommend a value of 0.47 $\mu$ F or lower for this capacitor.)

### 4. Protection circuits

- Due to the system structure of the protection circuit for shorts to V<sub>CC</sub> or ground, if there is a DC resistance between the amplifier output pins and ground, the protection circuit may operate when power is first applied and the amplifier may fail to turn on. The basic design approach we recommend is not to adopt any designs in which there is a DC resistance between the amplifier outputs and ground.
- The LA4628 includes a built-in thermal protection circuit to prevent the IC from being damaged or destroyed if abnormally high temperatures occur. This thermal protection circuit gradually reduces the output if the IC junction temperature (T<sub>j</sub>) reaches the range 170 to 180°C due to inadequate heat sinking or other problem. If the temperature falls, the amplifier will restart automatically.
- The LA4628 also includes other protection circuits. Use of these circuits also requires care during end product design and testing.

### 5. Other notes

- The LA4628 is a BTL power amplifier. When testing this device, the ground systems for the test equipment connected to IC inputs, and that for the test equipment connected to IC outputs, must be isolated. Do not use a common ground.

## Printed Circuit Pattern

(copper foil side)

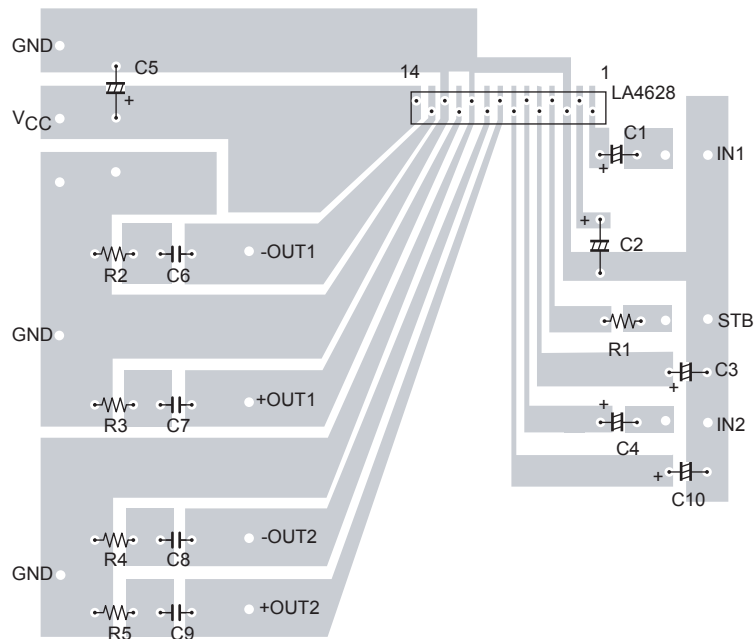

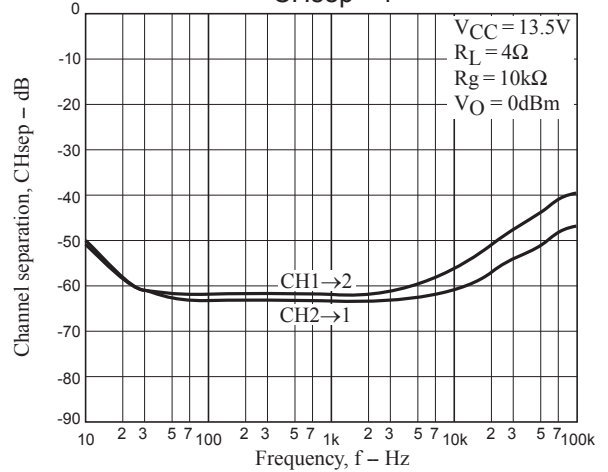
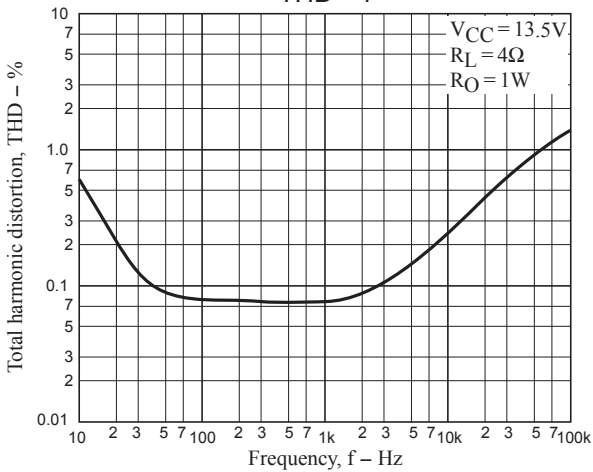
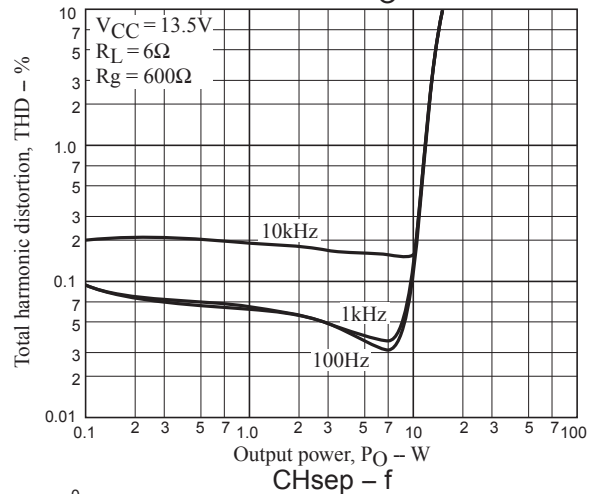
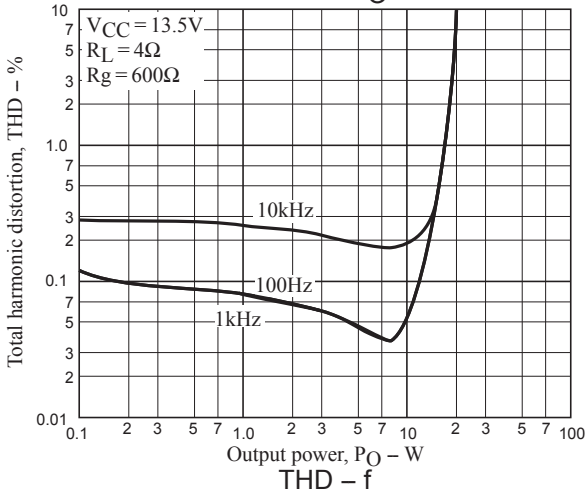
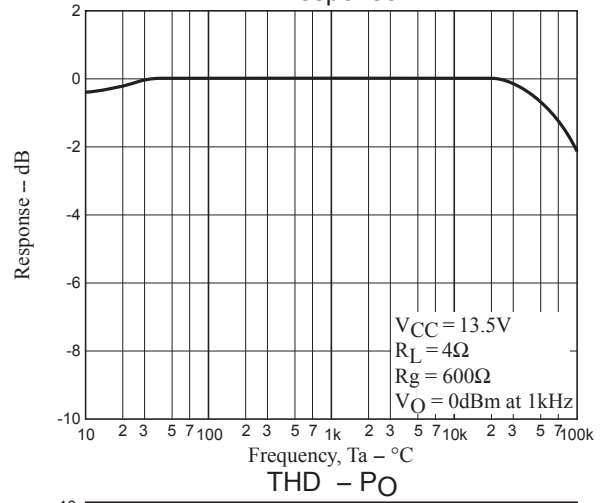
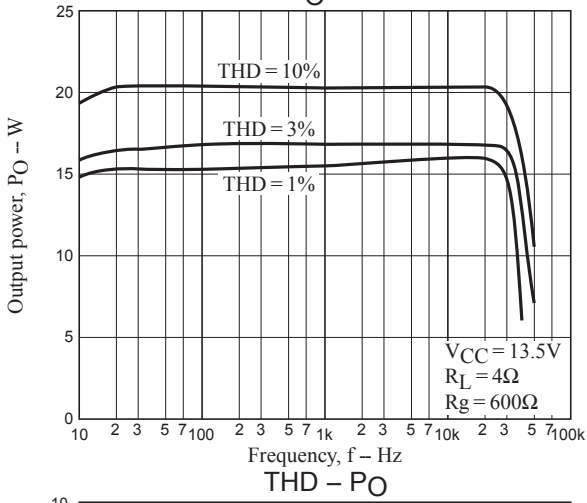
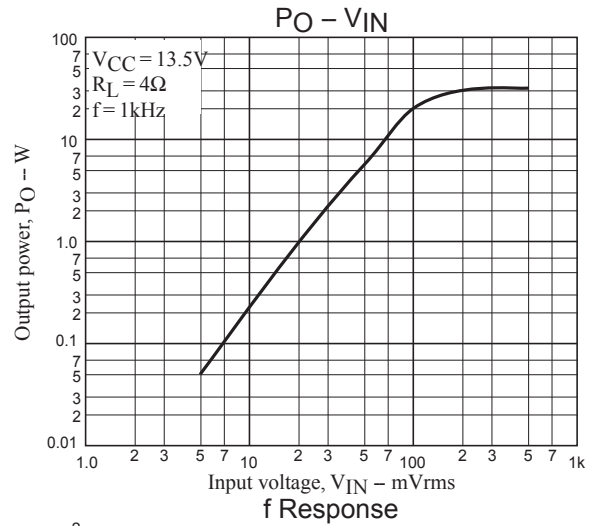
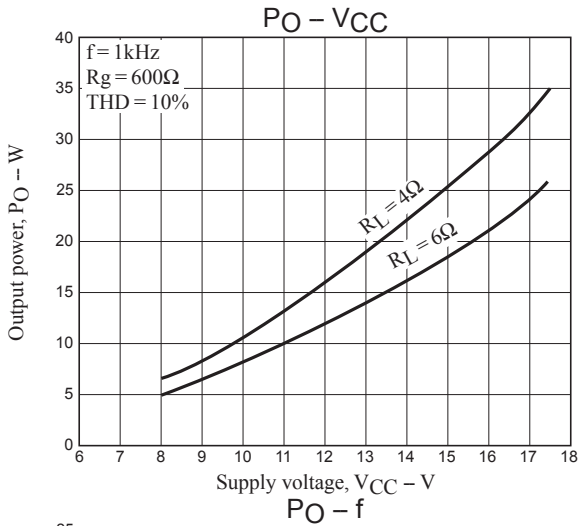

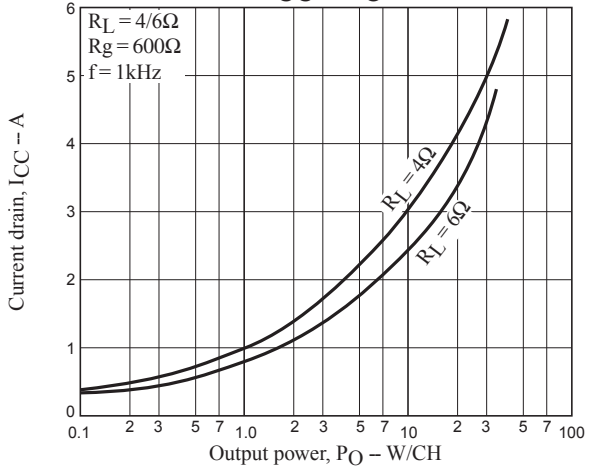
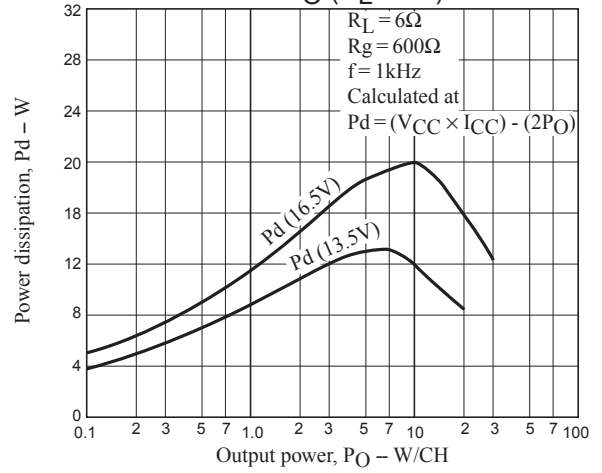
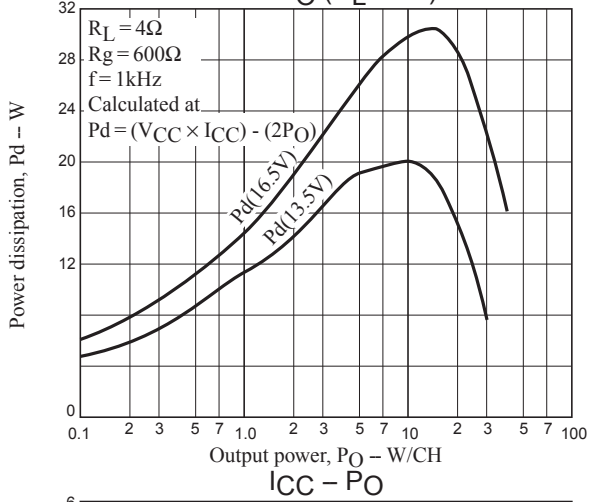
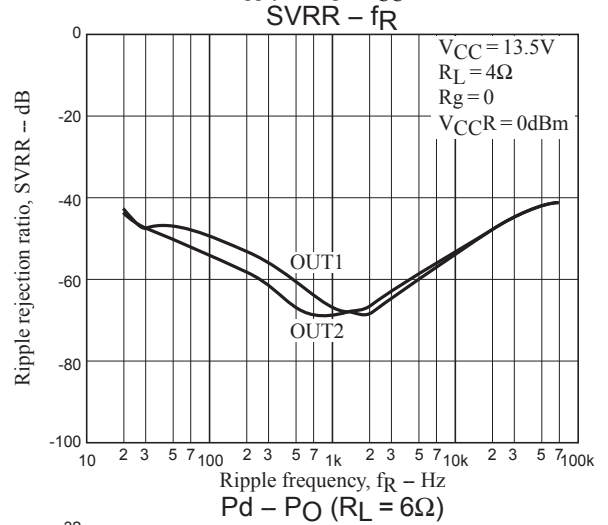
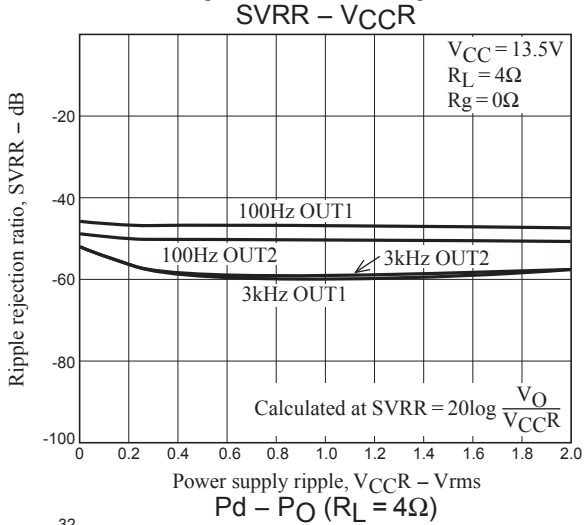
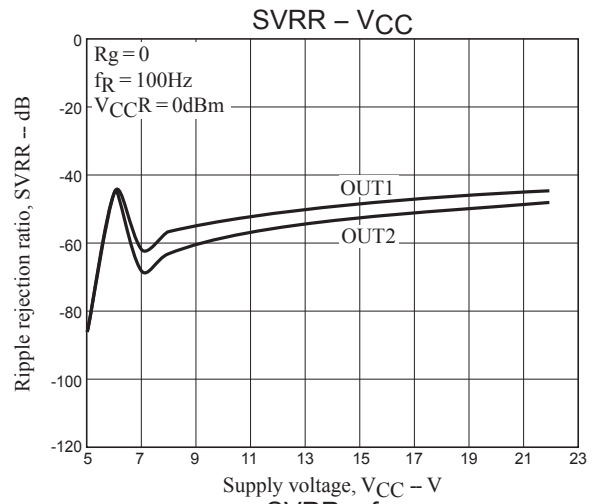
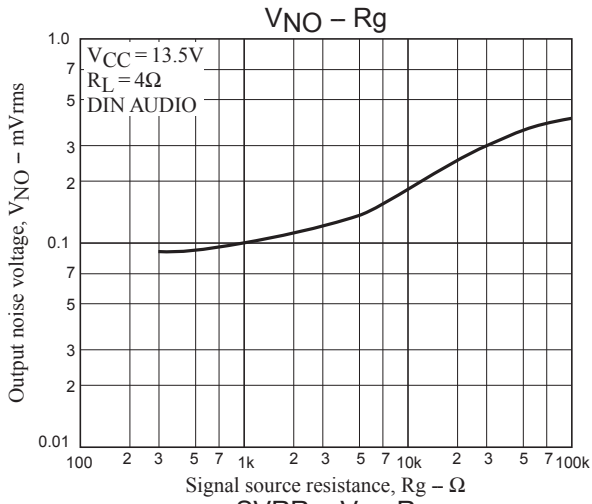



ON Semiconductor and the ON logo are registered trademarks of Semiconductor Components Industries, LLC (SCILLC). SCILLC owns the rights to a number of patents, trademarks, copyrights, trade secrets, and other intellectual property. A listing of SCILLC's product/patent coverage may be accessed at [www.onsemi.com/site/pdf/Patent-Marking.pdf](http://www.onsemi.com/site/pdf/Patent-Marking.pdf). SCILLC reserves the right to make changes without further notice to any products herein. SCILLC makes no warranty, representation or guarantee regarding the suitability of its products for any particular purpose, nor does SCILLC assume any liability arising out of the application or use of any product or circuit, and specifically disclaims any and all liability, including without limitation special, consequential or incidental damages. "Typical" parameters which may be provided in SCILLC data sheets and/or specifications can and do vary in different applications and actual performance may vary over time. All operating parameters, including "Typicals" must be validated for each customer application by customer's technical experts. SCILLC does not convey any license under its patent rights nor the rights of others. SCILLC products are not designed, intended, or authorized for use as components in systems intended for surgical implant into the body, or other applications intended to support or sustain life, or for any other application in which the failure of the SCILLC product could create a situation where personal injury or death may occur. Should Buyer purchase or use SCILLC products for any such unintended or unauthorized application, Buyer shall indemnify and hold SCILLC and its officers, employees, subsidiaries, affiliates, and distributors harmless against all claims, costs, damages, and expenses, and reasonable attorney fees arising out of, directly or indirectly, any claim of personal injury or death associated with such unintended or unauthorized use, even if such claim alleges that SCILLC was negligent regarding the design or manufacture of the part. SCILLC is an Equal Opportunity/Affirmative Action Employer. This literature is subject to all applicable copyright laws and is not for resale in any manner.

## Looking for pricing, stock, or lifecycle information?

Click below to explore more details on WIN SOURCE:

-  [View LA4628-E on WIN SOURCE](#)
-  [ON Semiconductor](#) Information

## Optimize Your Supply Chain with WIN SOURCE Solutions

-  Global Sourcing Solution
-  Obsolete Management
-  Cost Control Management
-  Shortage Management
-  Alternative Solution
-  Excess Inventory Management