



# THE DATASHEET OF L6571B



## High voltage half bridge driver with oscillator

### Features

- High voltage rail up to 600 V
- BCD off line technology
- 15.6 V Zener clamp on  $V_s$
- Driver current capability:
  - Sink current = 270 mA
  - Source current = 170 mA
- Very low start up current: 150 mA
- Undervoltage lockout with hysteresis
- Programmable oscillator frequency
- Dead time 1.25  $\mu$ s (L6571A) or 0.72  $\mu$ s (L6571B)
- $dV/dt$  immunity up to  $\pm 50$  V/ns
- ESD protection

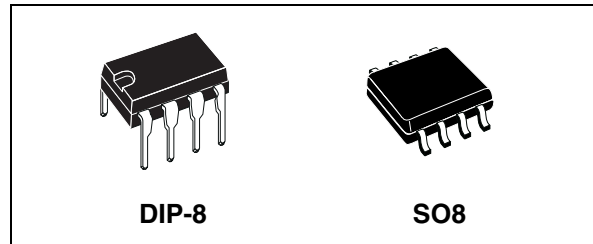

can be programmed using external resistor and capacitor.

The internal circuitry of the device allows it to be driven also by external logic signal.

The output drivers are designed to drive external nchannel power MOSFET and IGBT. The internal logic assures a dead time to avoid cross-conduction of the power devices.

Two version are available: L6571A and L6571B. They differ in the internal dead time: 1.25 $\mu$ s and 0.72  $\mu$ s (typ.)

### Description

The device is a high voltage half bridge driver with built in oscillator. The frequency of the oscillator

**Figure 1. Block diagram**

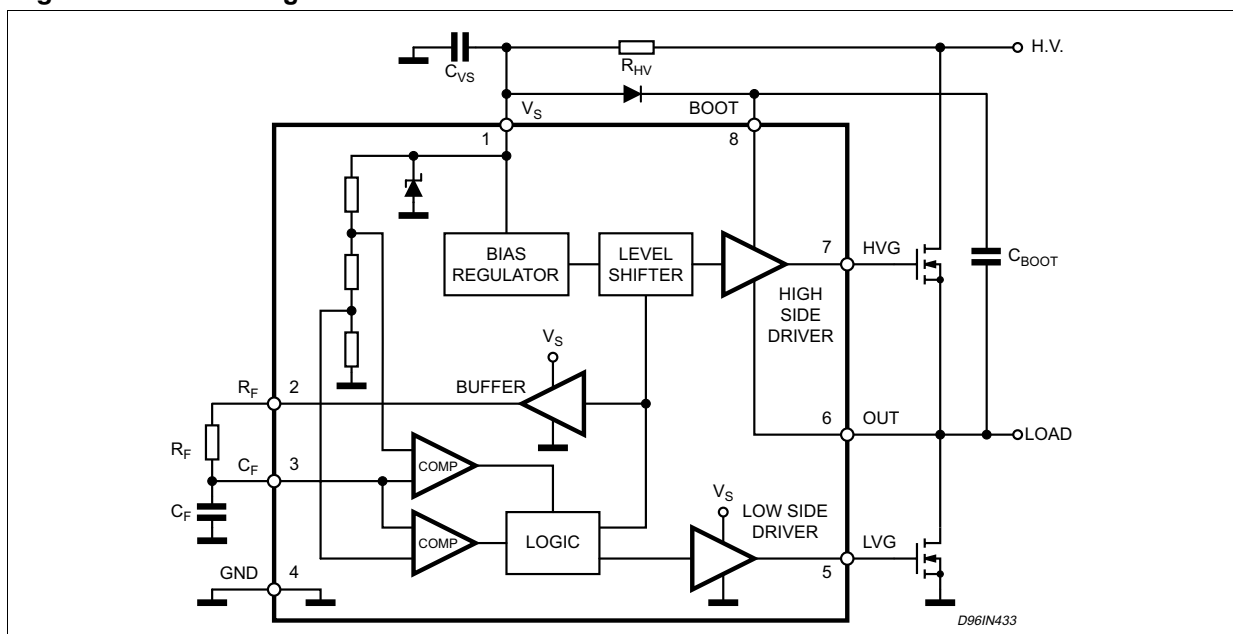

# Contents

<b>1</b>	<b>Maximum ratings</b> .....	<b>3</b>
1.1	Absolute maximum ratings .....	3
1.2	Thermal data .....	3
1.3	Recommended operating conditions .....	3
<b>2</b>	<b>Pin connection</b> .....	<b>4</b>
<b>3</b>	<b>Electrical data</b> .....	<b>5</b>
<b>4</b>	<b>Oscillator frequency</b> .....	<b>6</b>
<b>5</b>	<b>Package mechanical data</b> .....	<b>8</b>
<b>6</b>	<b>Order information</b> .....	<b>10</b>
<b>7</b>	<b>Revision history</b> .....	<b>11</b>

# 1 Maximum ratings

## 1.1 Absolute maximum ratings

**Table 1. Absolute maximum ratings**

Symbol	Parameter	Value	Unit
$I_S^{(1)}$	Supply current	25	mA
$V_{CF}$	Oscillator resistor voltage	18	V
$V_{LVG}$	Low side switch gate output	14.6	V
$V_{OUT}$	High side switch source output	-1 to $V_{BOOT} - 18$	V
$V_{HVG}$	High side switch gate output	-1 to $V_{BOOT}$	V
$V_{BOOT}$	Floating supply voltage	618	V
$V_{BOOT/OUT}$	Floating supply vs OUT voltage	18	V
$dV_{BOOT}/dt$	VBOOT slew rate (Repetitive)	$\pm 50$	V/ns
$dV_{OUT}/dt$	VOUT slew rate (Repetitive)	$\pm 50$	V/ns
$T_{stg}$	Storage temperature	-40 to 150	°C
$T_J$	Junction temperature	-40 to 150	°C
$T_{amb}$	Ambient temperature (Operative)	-40 to 125	°C

1. The device has an internal zener clamp between GND and VS (typical 15.6 V). Therefore the circuit should not be driven by a DC low impedance power source.

*Note:* ESD immunity for pins 6, 7 and 8 is guaranteed up to 900 V (human body model)

## 1.2 Thermal data

**Table 2. Thermal data**

Symbol	Parameter	MDIP8	SO8	Unit
$R_{thJA}$	Thermal resistance junction-ambient max	100	150	°C/W

## 1.3 Recommended operating conditions

**Table 3. Recommended operating conditions**

Symbol	Parameter	Min.	Max.	Unit
$V_S$	Supply voltage	10	VCL	V
$V_{BOOT}$	Floating supply voltage	-	500	V
$V_{OUT}$	High side switch source output	-1	$V_{BOOT} - VCL$	V
$f_{out}$	Oscillation frequency		200	kHz

## 2 Pin connection

Figure 2. Pin connection

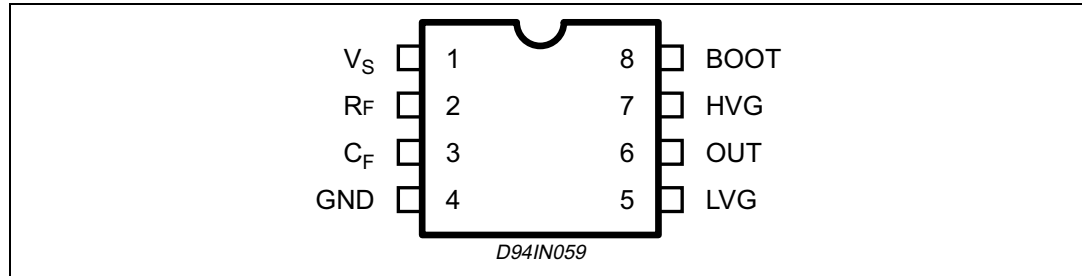

Table 4. Pin description

N°	Pin	Description
1	VS	Supply input voltage with internal clamp [typ. 15.6V]
2	RF	Oscillator timing resistor pin. A buffer set alternatively to VS and GND can provide current to the external resistor RF connected between pin 2 and 3. Alternatively, the signal on pin 2 can be used also to drive another IC (i.e. another L6569/71 to drive a full H-bridge)
3	CF	Oscillator timing capacitor pin. A capacitor connected between this pin and GND fixes (together with RF) the oscillating frequency. Alternatively an external logic signal can be applied to the pin to drive the IC.
4	GND	Ground
5	LVG	Low side driver output. The output stage can deliver 170mA source and 270mA sink [typ.values].
6	OUT	Upper driver floating reference
7	HVG	High side driver output. The output stage can deliver 170mA source and 270mA sink [typ.values].
8	BOOT	Bootstrap voltage supply. It is the upper driver floating supply.

### 3 Electrical data

$V_S = 12V$ ;  $V_{BOOT} - V_{OUT} = 12V$ ;  $T_j = 25\text{ }^\circ\text{C}$ ; unless otherwise specified.

**Table 5. Electrical characteristics**

Symbol	Pin	Parameter	Test Condition	Min.	Typ.	Max.	Unit
$V_{SUV P}$	1	VS turn on threshold		8.3	9	9.7	V
$V_{SUV N}$		VS turn off threshold		7.3	8	8.7	V
$V_{SUV H}$		VS hysteresis		0.7	1	1.3	V
$V_{CL}$		VS clamping voltage	$I_S = 5\text{ mA}$	14.6	15.6	16.6	V
$I_{SU}$		Start up current	$V_S < V_{SUV N}$		150	250	$\mu\text{A}$
$I_q$		Quiescent current	$V_S > V_{SUV P}$		500	700	$\mu\text{A}$
$I_{BOOTLK}$	8	Leakage current BOOT pin vs GND	$V_{BOOT} = 580V$			5	$\mu\text{A}$
$I_{OUTLK}$	6	Leakage current OUT pin vs GND	$V_{OUT} = 562V$			5	$\mu\text{A}$
$I_{HVG SO}$	7	High side driver source current	$V_{HVG} = 6V$	110	175		mA
$I_{HVG SI}$		High side driver sink current	$V_{HVG} = 6V$	190	275		mA
$I_{LVG SO}$	5	Low side driver source current	$V_{LVG} = 6V$	110	175		mA
$I_{LVG SI}$		Low side driver sink current	$V_{LVG} = 6V$	190	275		mA
$V_{RF ON}$	2	RF high level output voltage	$I_{RF} = 1\text{mA}$	$V_S - 0.05$		$V_S - 0.2$	V
$V_{RF OFF}$		RF low level output voltage	$I_{RF} = -1\text{mA}$	50		200	mV
$V_{CFU}$	3	CF upper threshold		7.7	8	8.2	V
$V_{CFL}$		CF lower threshold		3.80	4	4.3	V
$t_d$		Internal dead time	L6571A L6571B	0.85 0.50	1.25 0.72	1.65 0.94	$\mu\text{s}$ $\mu\text{s}$
DC		Duty cycle, ratio between dead Time + conduction time of high Side and low side drivers		0.45	0.5	0.55	
$I_{AVE}$	1	Average current from Vs	No Load, $f_s = 60\text{KHz}$		1.2	1.5	mA
$f_{out}$	6	Oscillation frequency	$RT = 12\text{K}$ ; $CT = 1\text{nF}$	57	60	63	kHz

## 4 Oscillator frequency

The frequency of the internal oscillator can be programmed using external resistor and capacitor.

The nominal oscillator frequency can be calculated using the following equation:

**Equation 1**

$$f_{osc} = \frac{1}{2 \cdot R_F \cdot C_F \cdot \ln 2} = \frac{1}{1.3863 \cdot R_F \cdot C_F}$$

Where  $R_F$  and  $C_F$  are the external resistor and capacitor.

The device can be driven in "shut down" condition keeping the  $C_F$  pin close to GND, but some cares have to be taken:

1. When  $C_F$  is to GND the high side driver is off and the low side is on
2. The forced discharge of the oscillator capacitor  $C_F$  must not be shorter than 1us: a simple way to do this is to limit the current discharge with a resistive path imposing  $R \cdot C_F > 1 \mu s$  (see fig.1)

**Figure 3. Fault signal**

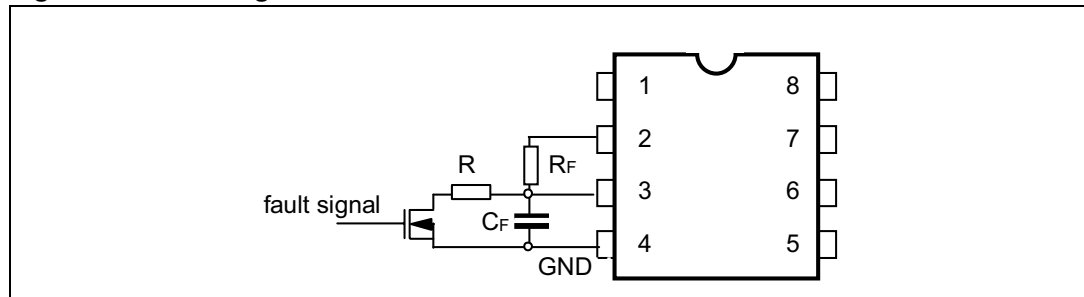

**Figure 4. Waveforms**

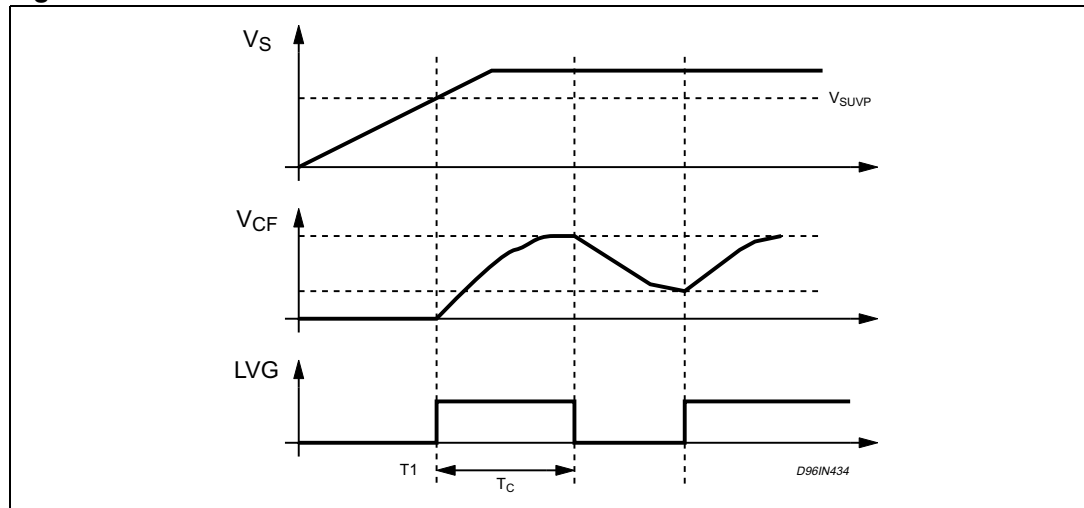

**Figure 5. Typical dead time vs. temperature dependency (L6571A)**

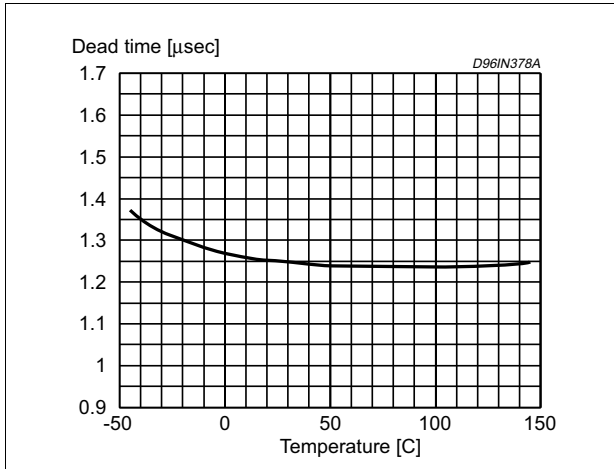

**Figure 6. Typical rise and fall times vs. load capacitance**

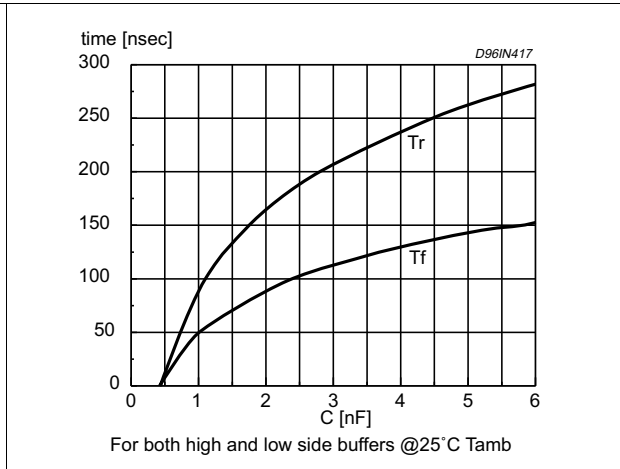

**Figure 7. Typical frequency vs temperature dependency**

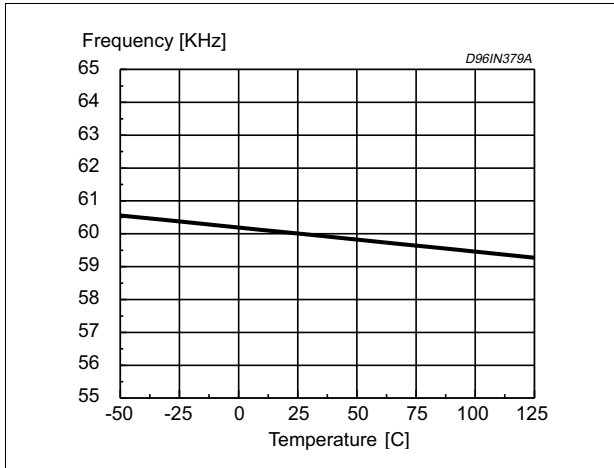

**Figure 8. Quiescent current vs. supply voltage**

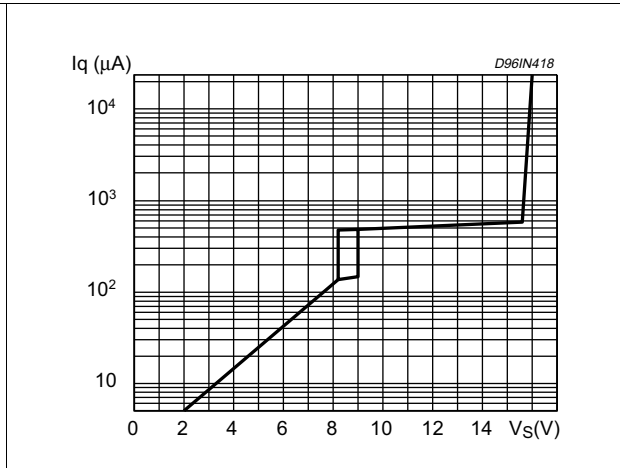

**Figure 9. Typical and theoretical oscillator frequency vs resistor value**

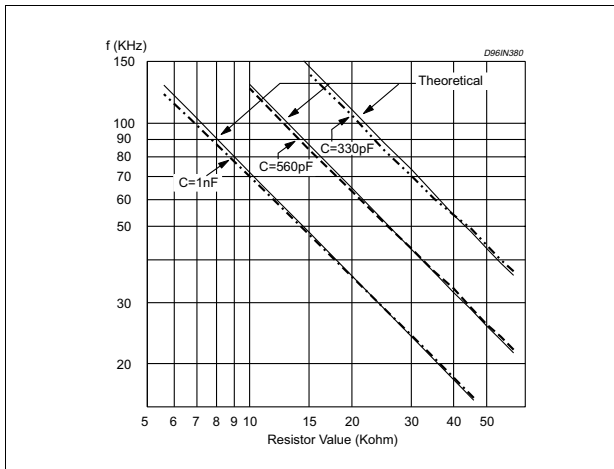

## 5 Package mechanical data

In order to meet environmental requirements, ST offers these devices in different grades of ECOPACK<sup>®</sup> packages, depending on their level of environmental compliance. ECOPACK<sup>®</sup> specifications, grade definitions and product status are available at: [www.st.com](http://www.st.com). ECOPACK<sup>®</sup> is an ST trademark.

**Figure 10. DIP-8 mechanical data**

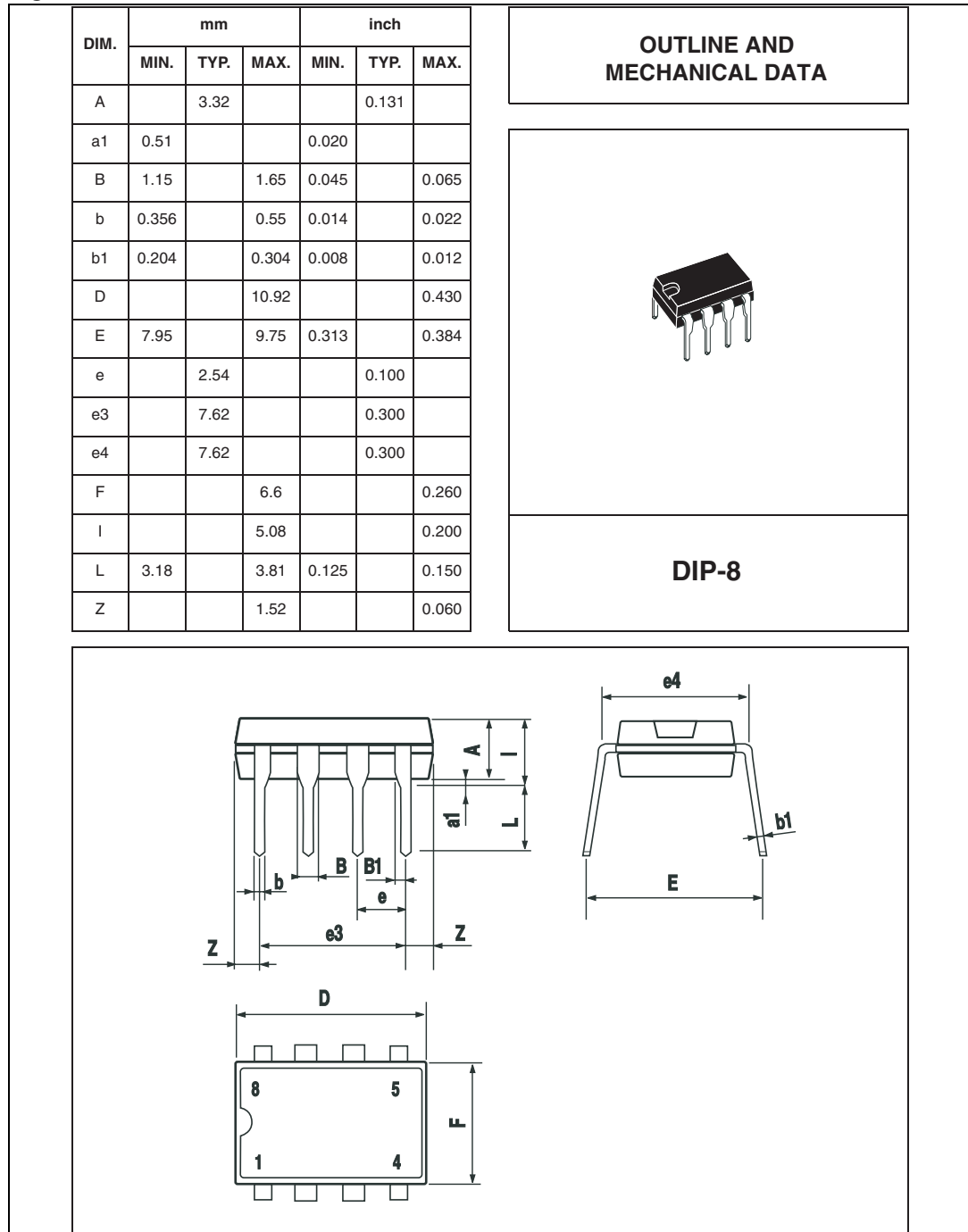
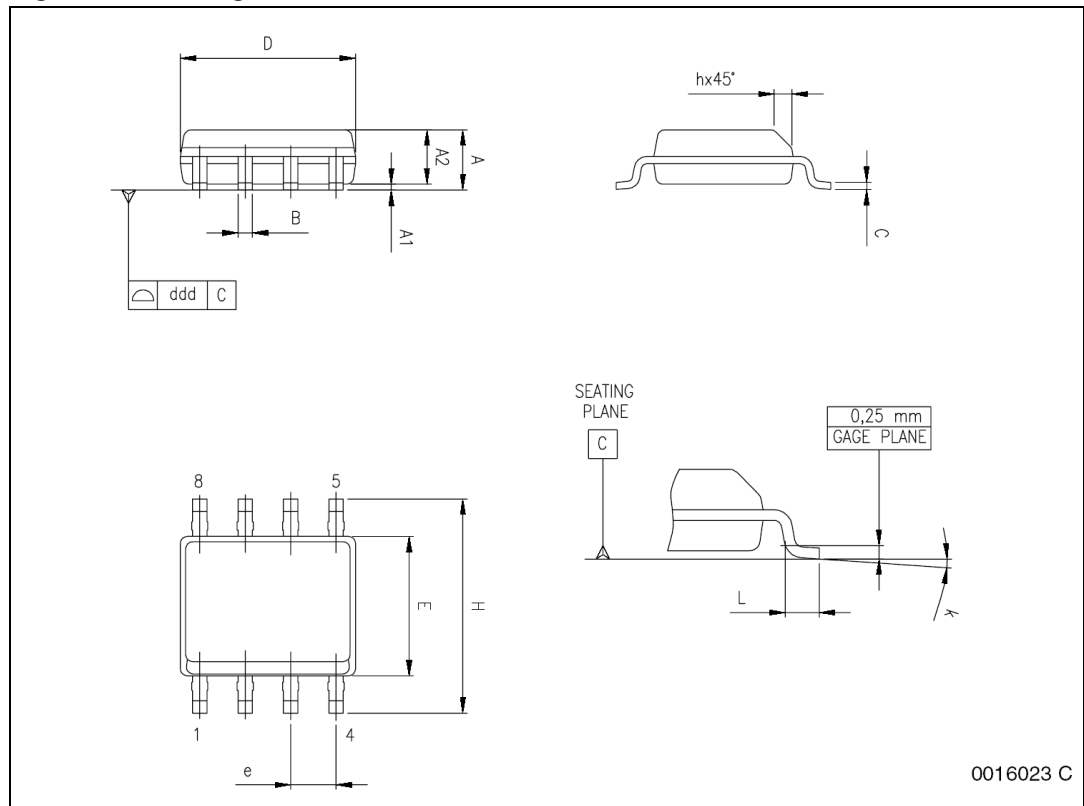

Table 1. SO-8 mechanical data

Dim.	mm.			inch		
	Min	Typ	Max	Min	Typ	Max
A	1.35		1.75	0.053		0.069
A1	0.10		0.25	0.004		0.010
A2	1.10		1.65	0.043		0.065
B	0.33		0.51	0.013		0.020
C	0.19		0.25	0.007		0.010
D (1)	4.80		5.00	0.189		0.197
E	3.80		4.00	0.15		0.157
e		1.27			0.050	
H	5.80		6.20	0.228		0.244
h	0.25		0.50	0.010		0.020
L	0.40		1.27	0.016		0.050
k	0° (min.), 8° (max.)					
ddd			0.10			0.004

1. Dimensions D does not include mold flash, protrusions or gate burrs. Mold flash, protrusions or gate burrs shall not exceed 0.15mm (.006inch) in total (both side).

Figure 11. Package dimensions



0016023 C

## 6 Order information

**Table 6. Ordering information**

Order codes	Package	Packaging
L6571A	DIP-8	Tube
L6571AD	SO8	
L6571AD013TR		Tape and reel
L6571B	DIP-8	Tube
L6571BD	SO8	
L6571BD013TR		Tape and reel

## 7 Revision history

**Table 7. Document revision history**

Date	Revision	Changes
14-Jan-2004	5	No history because migration
15-Jan-2010	6	Updated <a href="#">Table 6 on page 10</a>

**Please Read Carefully:**

Information in this document is provided solely in connection with ST products. STMicroelectronics NV and its subsidiaries ("ST") reserve the right to make changes, corrections, modifications or improvements, to this document, and the products and services described herein at any time, without notice.

All ST products are sold pursuant to ST's terms and conditions of sale.

Purchasers are solely responsible for the choice, selection and use of the ST products and services described herein, and ST assumes no liability whatsoever relating to the choice, selection or use of the ST products and services described herein.

No license, express or implied, by estoppel or otherwise, to any intellectual property rights is granted under this document. If any part of this document refers to any third party products or services it shall not be deemed a license grant by ST for the use of such third party products or services, or any intellectual property contained therein or considered as a warranty covering the use in any manner whatsoever of such third party products or services or any intellectual property contained therein.

**UNLESS OTHERWISE SET FORTH IN ST'S TERMS AND CONDITIONS OF SALE ST DISCLAIMS ANY EXPRESS OR IMPLIED WARRANTY WITH RESPECT TO THE USE AND/OR SALE OF ST PRODUCTS INCLUDING WITHOUT LIMITATION IMPLIED WARRANTIES OF MERCHANTABILITY, FITNESS FOR A PARTICULAR PURPOSE (AND THEIR EQUIVALENTS UNDER THE LAWS OF ANY JURISDICTION), OR INFRINGEMENT OF ANY PATENT, COPYRIGHT OR OTHER INTELLECTUAL PROPERTY RIGHT.**

**UNLESS EXPRESSLY APPROVED IN WRITING BY AN AUTHORIZED ST REPRESENTATIVE, ST PRODUCTS ARE NOT RECOMMENDED, AUTHORIZED OR WARRANTED FOR USE IN MILITARY, AIR CRAFT, SPACE, LIFE SAVING, OR LIFE SUSTAINING APPLICATIONS, NOR IN PRODUCTS OR SYSTEMS WHERE FAILURE OR MALFUNCTION MAY RESULT IN PERSONAL INJURY, DEATH, OR SEVERE PROPERTY OR ENVIRONMENTAL DAMAGE. ST PRODUCTS WHICH ARE NOT SPECIFIED AS "AUTOMOTIVE GRADE" MAY ONLY BE USED IN AUTOMOTIVE APPLICATIONS AT USER'S OWN RISK.**

Resale of ST products with provisions different from the statements and/or technical features set forth in this document shall immediately void any warranty granted by ST for the ST product or service described herein and shall not create or extend in any manner whatsoever, any liability of ST.

ST and the ST logo are trademarks or registered trademarks of ST in various countries.

Information in this document supersedes and replaces all information previously supplied.

The ST logo is a registered trademark of STMicroelectronics. All other names are the property of their respective owners.

© 2010 STMicroelectronics - All rights reserved



STMicroelectronics group of companies

Australia - Belgium - Brazil - Canada - China - Czech Republic - Finland - France - Germany - Hong Kong - India - Israel - Italy - Japan - Malaysia - Malta - Morocco - Philippines - Singapore - Spain - Sweden - Switzerland - United Kingdom - United States of America

[www.st.com](http://www.st.com)

## Looking for pricing, stock, or lifecycle information?

Click below to explore more details on WIN SOURCE:

-  [View L6571B on WIN SOURCE](#)
-  [STMicroelectronics](#) Information

## Optimize Your Supply Chain with WIN SOURCE Solutions

-  Global Sourcing Solution
-  Obsolete Management
-  Cost Control Management
-  Shortage Management
-  Alternative Solution
-  Excess Inventory Management