

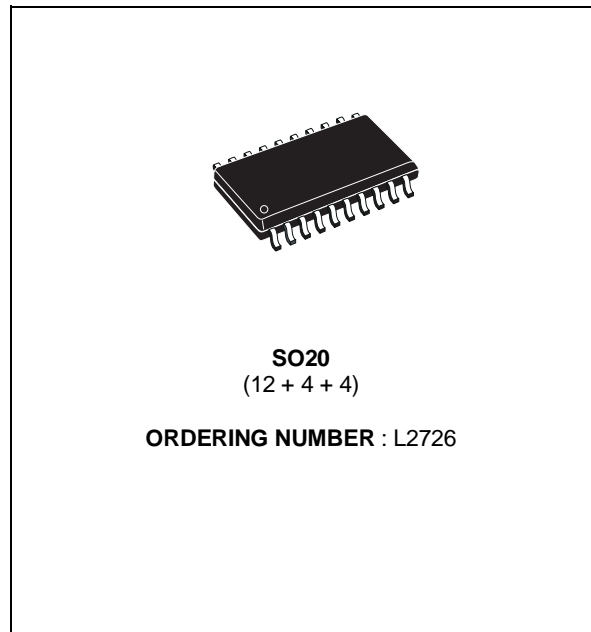


**THE DATASHEET OF  
L2726013TR**



## LOW DROP DUAL POWER OPERATIONAL AMPLIFIER

- OUTPUT CURRENT TO 1 A
- OPERATES AT LOW VOLTAGES
- SINGLE OR SPLIT SUPPLY
- LARGE COMMON-MODE AND DIFFERENTIAL MODE RANGE
- LOW INPUT OFFSET VOLTAGE
- GROUND COMPATIBLE INPUTS
- LOW SATURATION VOLTAGE
- THERMAL SHUTDOWN
- CLAMP DIODE



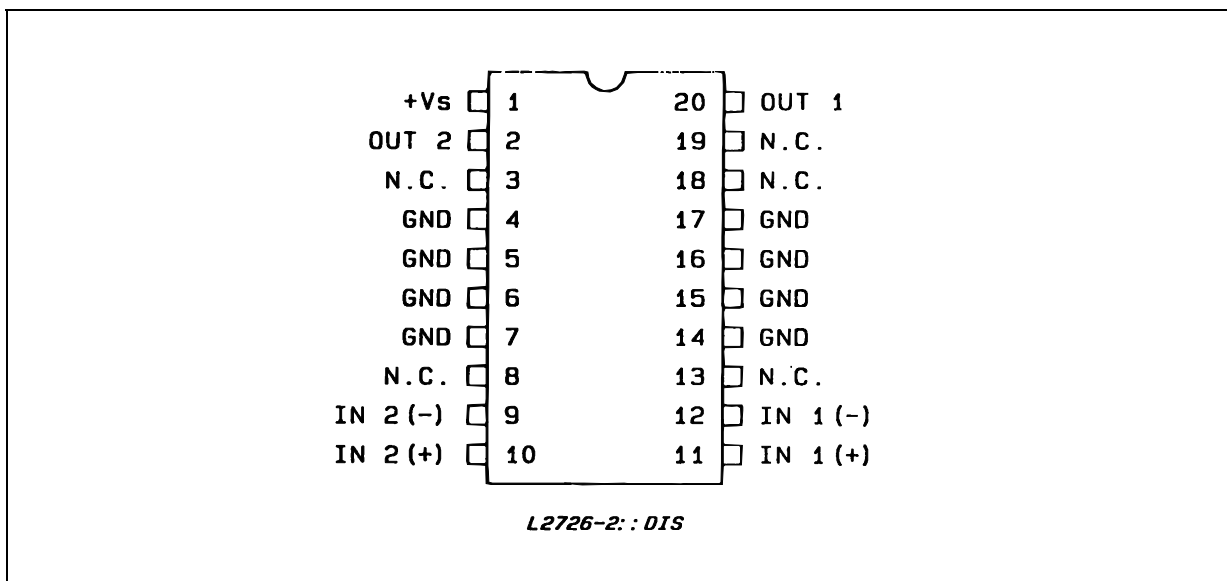
### DESCRIPTION

The L2726 is a monolithic integrated circuit in SO-20 package intended for use as power operational amplifiers in a wide range of applications including servo amplifiers and power supplies.

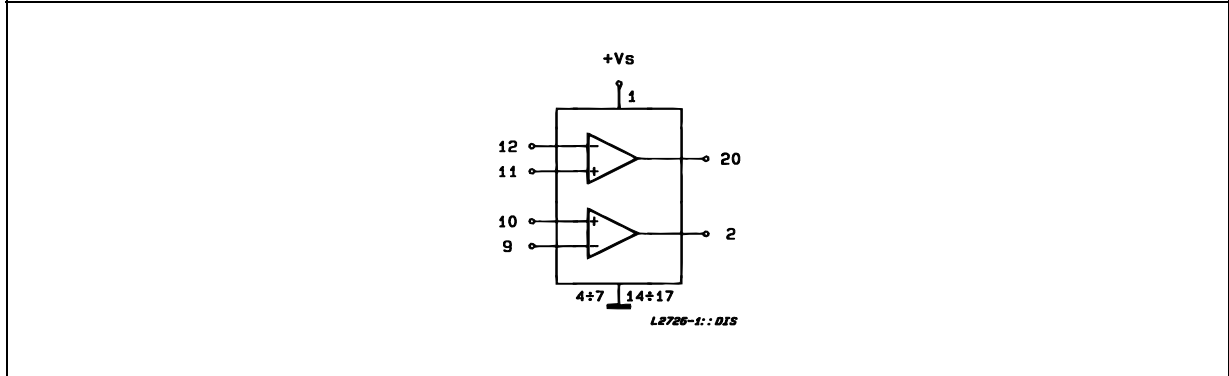
It is particularly indicated for driving inductive loads, as motor and finds applications in compact-disc VCR automotive, etc.

The high gain and high output power capability provide superior performance whatever an operational amplifier/power booster combination is required.

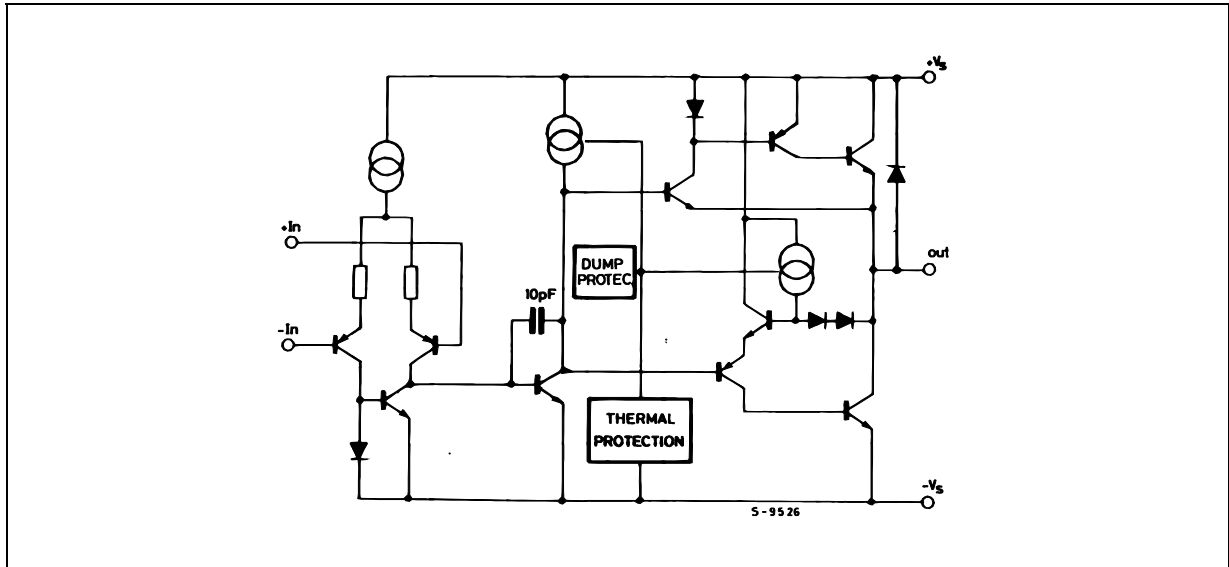
### PIN CONNECTION (top view)



**BLOCK DIAGRAM**



**SCHEMATIC DIAGRAM (one section)**



**ABSOLUTE MAXIMUM RATINGS**

Symbol	Parameter	Value	Unit	
$V_s$	Supply Voltage	28	V	
$V_s$	Peak Supply Voltage (50ms)	50	V	
$V_i$	Input Voltage	$V_s$		
$V_i$	Differential Input Voltage	$\pm V_s$		
$I_O$	DC Output Current	1	A	
$I_p$	Peak Output Current (non repetitive)	1.5	A	
$P_{tot}$	Power Dissipation at	$T_{amb} = 85^{\circ}C$ $T_{case} = 75^{\circ}C$	1 5	W
$T_{op}$	Operating Temperature	- 40 to 85	$^{\circ}C$	
$T_{stg}, T_j$	Storage and Junction Temperature	- 40 to 150	$^{\circ}C$	

**THERMAL DATA**

$R_{th\ j-case}$	Thermal Resistance Junction-case	Max.	15.0	$^{\circ}C/W$
$R_{th\ j-amb}$	Thermal Resistance Junction-ambient (*)	Max.	65	$^{\circ}C/W$

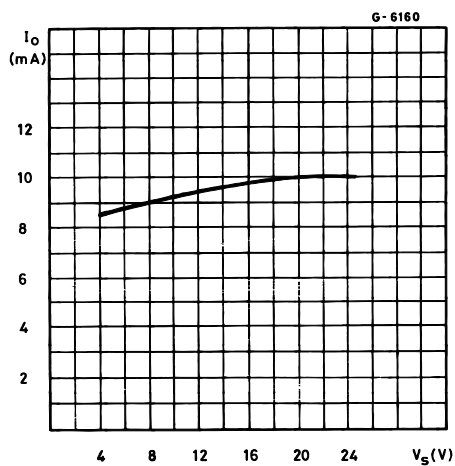
(\*) With 4 sq. cm copper area heatsink.

**ELECTRICAL CHARACTERISTICS**

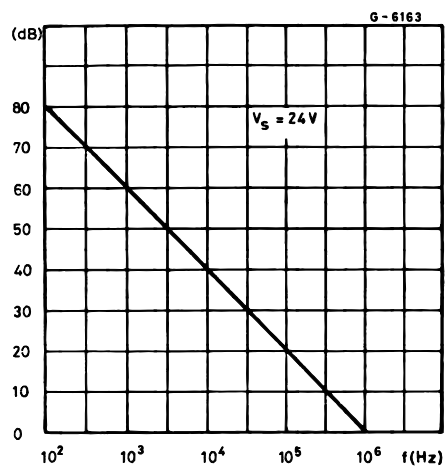
$V_s = 24V$ ,  $T_{amb} = 25^\circ C$  unless otherwise specified

Symbol	Parameter	Test Conditions	Min.	Typ.	Max.	Unit
$V_s$	Single Supply Voltage		4		28	V
$V_s$	Split Supply Voltage		$\pm 2$		$\pm 14$	V
$I_s$	Quiescent Drain Current	$V_o = \frac{V_s}{2}$ $V_s = 24V$ $V_s = 24V$		10 9	15 15	mA
$I_b$	Input Bias Current			0.2	1	$\mu A$
$V_{os}$	Input Offset Voltage				10	mV
$I_{os}$	Input Offset Current				100	nA
SR	Slew Rate			2		V/ $\mu s$
B	Gain-bandwidth Product			1.2		MHz
$R_i$	Input Resistance		500			k $\Omega$
$G_v$	O. L. Voltage Gain	$f = 100Hz$ $f = 1kHz$	70	80 60		dB
$e_N$	Input Noise Voltage	$B = 22Hz$ to $22kHz$		10		$\mu V$
$I_N$	Input Noise Voltage			200		pA
CMR	Common Mode Rejection	$f = 1kHz$	66	84		dB
SVR	Supply Voltage Rejection	$f = 100Hz$ $R_G = 10k\Omega$ $V_R = 0.5V$ $V_s = 24V$ $V_s = \pm 12V$ $V_s = \pm 6V$	60	70 75 80		dB dB dB
$V_{DROP(HIGH)}$		$V_s = \pm 2.5V$ to $\pm 12V$ $I_p = 100mA$ $I_p = 500mA$		0.7 1	1.5	V
$V_{DROP(LOW)}$		$V_s = \pm 2.5V$ to $\pm 12V$ $I_p = 100mA$ $I_p = 500mA$		0.3 0.5	1	V
$C_s$	Channel Separation	$f = 1KHz$ $R_L = 10\Omega$ $G_v = 30dB$ $V_s = 24V$ $V_s = 6V$		60 60		dB
$T_{sd}$	Thermal Shutdown Junction Temperature		150			$^\circ C$

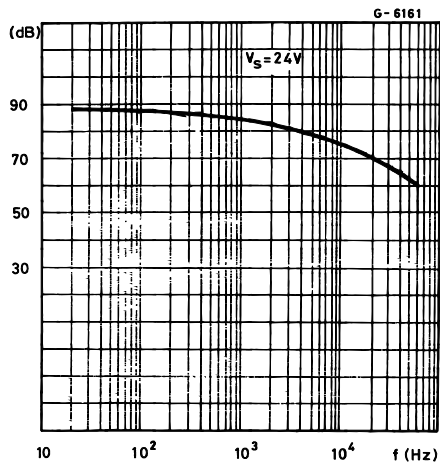
**Figure 1 : Quiescent Current vs. Supply Voltage**



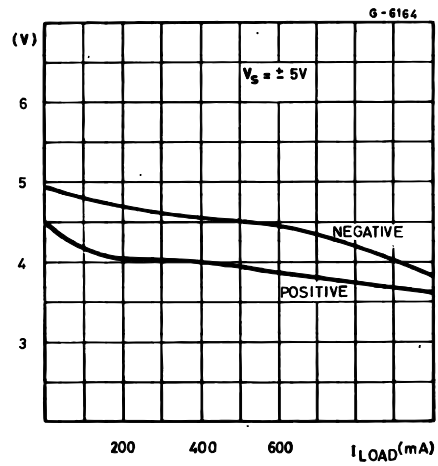
**Figure 2 : Open Loop Gain vs. Frequency**



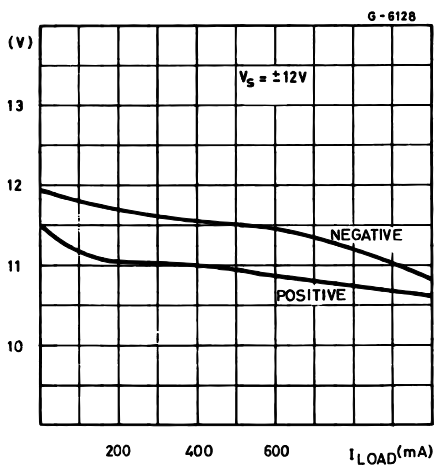
**Figure 3 : Common Mode Rejection Frequency**



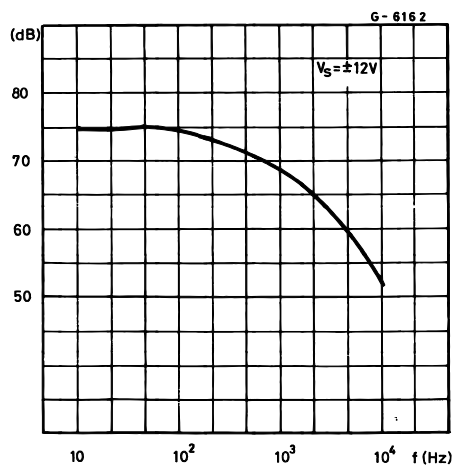
**Figure 4 : Output Swing vs. Load Current ( $V_S = \pm 5V$ )**



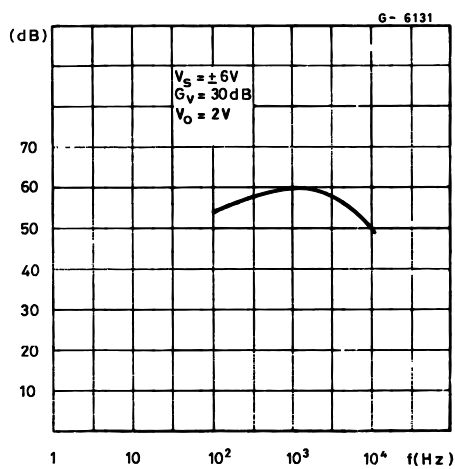
**Figure 5 : Output Swing vs. Load Current ( $V_S = \pm 12V$ )**



**Figure 6 : Supply Voltage Rejection vs. Frequency**

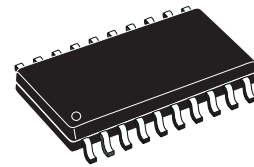


**Figure 7 : Channel Separation vs. Frequency.**

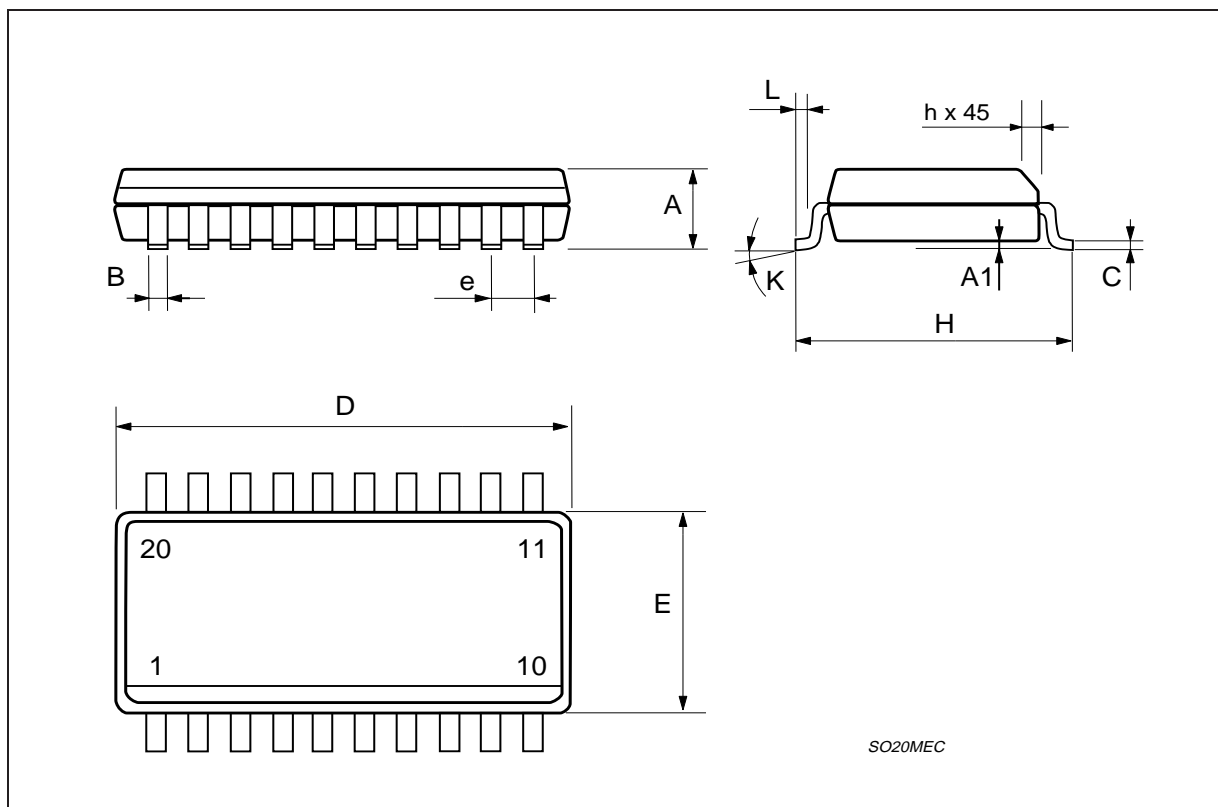


DIM.	mm			inch		
	MIN.	TYP.	MAX.	MIN.	TYP.	MAX.
A	2.35		2.65	0.093		0.104
A1	0.1		0.3	0.004		0.012
B	0.33		0.51	0.013		0.020
C	0.23		0.32	0.009		0.013
D	12.6		13	0.496		0.512
E	7.4		7.6	0.291		0.299
e		1.27			0.050	
H	10		10.65	0.394		0.419
h	0.25		0.75	0.010		0.030
L	0.4		1.27	0.016		0.050
K	0° (min.)8° (max.)					

## OUTLINE AND MECHANICAL DATA



**SO20**



Information furnished is believed to be accurate and reliable. However, STMicroelectronics assumes no responsibility for the consequences of use of such information nor for any infringement of patents or other rights of third parties which may result from its use. No license is granted by implication or otherwise under any patent or patent rights of STMicroelectronics. Specification mentioned in this publication are subject to change without notice. This publication supersedes and replaces all information previously supplied. STMicroelectronics products are not authorized for use as critical components in life support devices or systems without express written approval of STMicroelectronics.



The ST logo is a registered trademark of STMicroelectronics  
© 1998 STMicroelectronics – Printed in Italy – All Rights Reserved  
STMicroelectronics GROUP OF COMPANIES

Australia - Brazil - Canada - China - France - Germany - Italy - Japan - Korea - Malaysia - Malta - Mexico - Morocco - The Netherlands -  
Singapore - Spain - Sweden - Switzerland - Taiwan - Thailand - United Kingdom - U.S.A.

<http://www.st.com>

## Looking for pricing, stock, or lifecycle information?

Click below to explore more details on WIN SOURCE:

-  [View L2726013TR](#) on WIN SOURCE
-  [STMicroelectronics](#) Information

## Optimize Your Supply Chain with WIN SOURCE Solutions

-  Global Sourcing Solution
-  Obsolete Management
-  Cost Control Management
-  Shortage Management
-  Alternative Solution
-  Excess Inventory Management