



THE DATASHEET OF L2726



LOW DROP DUAL POWER OPERATIONAL AMPLIFIER

- OUTPUT CURRENT TO 1 A
- OPERATES AT LOW VOLTAGES
- SINGLE OR SPLIT SUPPLY
- LARGE COMMON-MODE AND DIFFERENTIAL MODE RANGE
- LOW INPUT OFFSET VOLTAGE
- GROUND COMPATIBLE INPUTS
- LOW SATURATION VOLTAGE
- THERMAL SHUTDOWN
- CLAMP DIODE

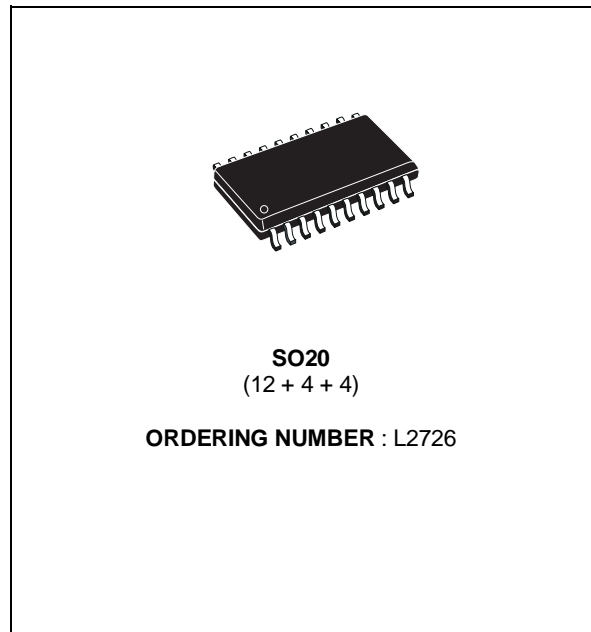

DESCRIPTION

The L2726 is a monolithic integrated circuit in SO-20 package intended for use as power operational amplifiers in a wide range of applications including servo amplifiers and power supplies.

It is particularly indicated for driving inductive loads, as motor and finds applications in compact-disc VCR automotive, etc.

The high gain and high output power capability provide superior performance whatever an operational amplifier/power booster combination is required.

PIN CONNECTION (top view)

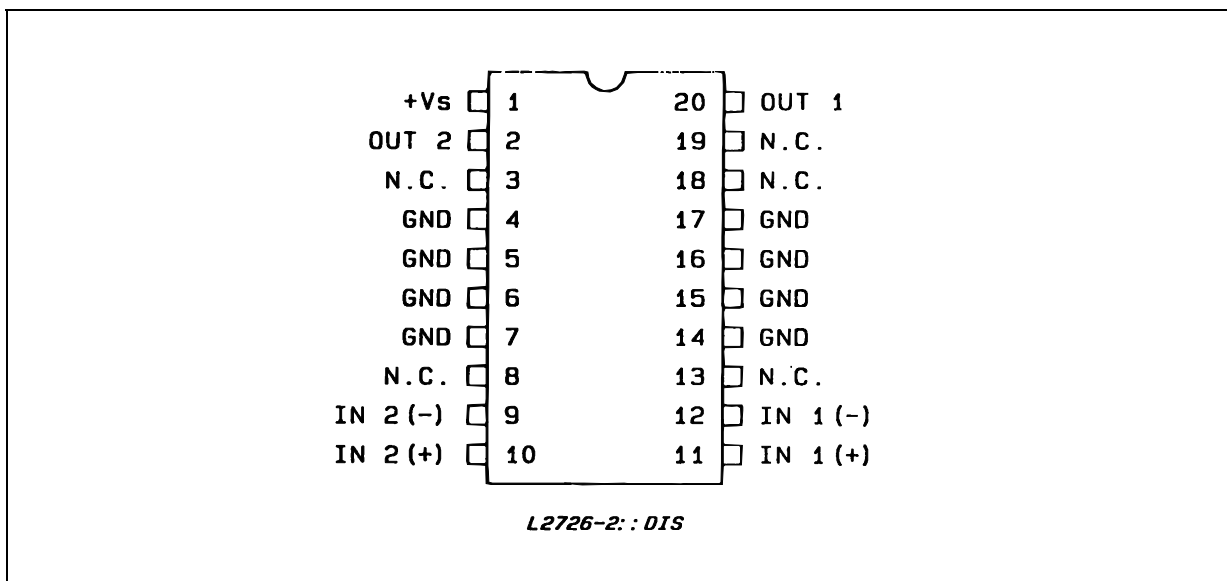

BLOCK DIAGRAM

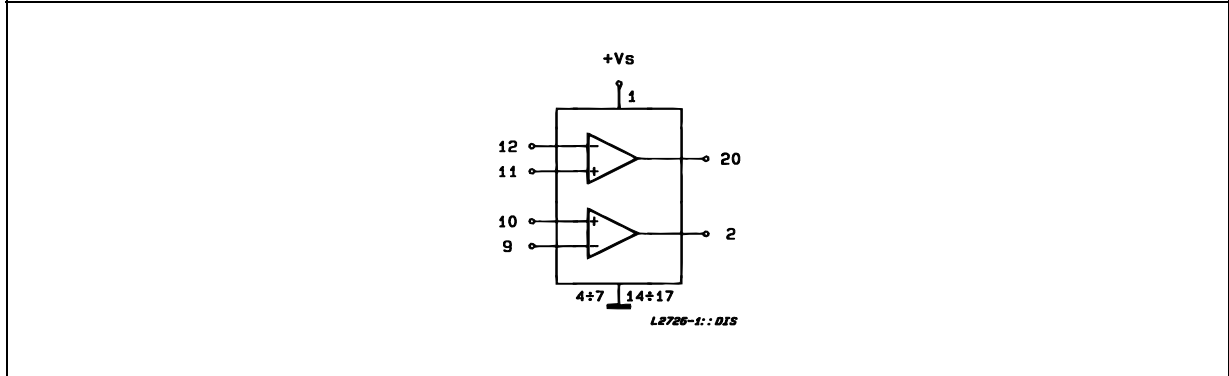

SCHEMATIC DIAGRAM (one section)

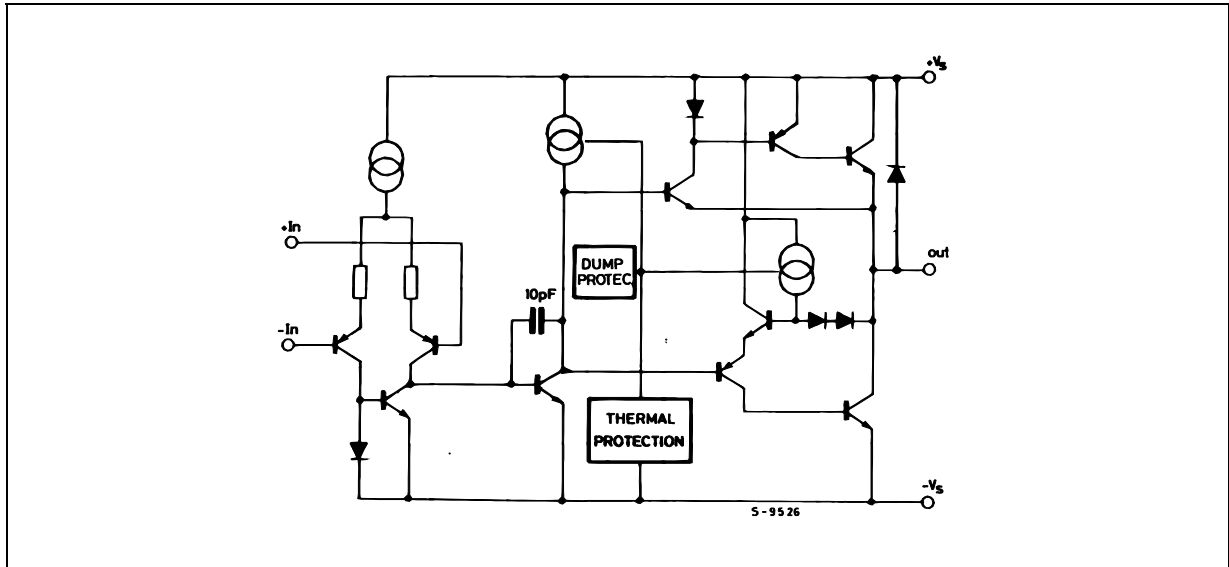

ABSOLUTE MAXIMUM RATINGS

Symbol	Parameter	Value	Unit	
V_s	Supply Voltage	28	V	
V_s	Peak Supply Voltage (50ms)	50	V	
V_i	Input Voltage	V_s		
V_i	Differential Input Voltage	$\pm V_s$		
I_O	DC Output Current	1	A	
I_p	Peak Output Current (non repetitive)	1.5	A	
P_{tot}	Power Dissipation at	$T_{amb} = 85^{\circ}C$ $T_{case} = 75^{\circ}C$	1 5	W
T_{op}	Operating Temperature	- 40 to 85	$^{\circ}C$	
T_{stg}, T_j	Storage and Junction Temperature	- 40 to 150	$^{\circ}C$	

THERMAL DATA

$R_{th\ j-case}$	Thermal Resistance Junction-case	Max.	15.0	$^{\circ}C/W$
$R_{th\ j-amb}$	Thermal Resistance Junction-ambient (*)	Max.	65	$^{\circ}C/W$

(*) With 4 sq. cm copper area heatsink.

ELECTRICAL CHARACTERISTICS

$V_s = 24V$, $T_{amb} = 25^{\circ}C$ unless otherwise specified

Symbol	Parameter	Test Conditions	Min.	Typ.	Max.	Unit
V_s	Single Supply Voltage		4		28	V
V_s	Split Supply Voltage		± 2		± 14	V
I_s	Quiescent Drain Current	$V_o = \frac{V_s}{2}$ $V_s = 24V$ $V_s = 24V$		10 9	15 15	mA
I_b	Input Bias Current			0.2	1	μA
V_{os}	Input Offset Voltage				10	mV
I_{os}	Input Offset Current				100	nA
SR	Slew Rate			2		V/ μs
B	Gain-bandwidth Product			1.2		MHz
R_i	Input Resistance		500			k Ω
G_v	O. L. Voltage Gain	$f = 100Hz$ $f = 1kHz$	70	80 60		dB
e_N	Input Noise Voltage	B = 22Hz to 22kHz		10		μV
I_N	Input Noise Voltage			200		pA
CMR	Common Mode Rejection	$f = 1kHz$	66	84		dB
SVR	Supply Voltage Rejection	$f = 100Hz$ $R_G = 10k\Omega$ $V_R = 0.5V$ $V_s = 24V$ $V_s = \pm 12V$ $V_s = \pm 6V$	60	70 75 80		dB dB dB
$V_{DROP(HIGH)}$		$V_s = \pm 2.5V$ to $\pm 12V$ $I_p = 100mA$ $I_p = 500mA$		0.7 1	1.5	V
$V_{DROP(LOW)}$		$V_s = \pm 2.5V$ to $\pm 12V$ $I_p = 100mA$ $I_p = 500mA$		0.3 0.5	1	V
C_s	Channel Separation	$f = 1KHz$ $R_L = 10\Omega$ $G_v = 30dB$ $V_s = 24V$ $V_s = 6V$		60 60		dB
T_{sd}	Thermal Shutdown Junction Temperature		150			$^{\circ}C$

Figure 1 : Quiescent Current vs. Supply Voltage

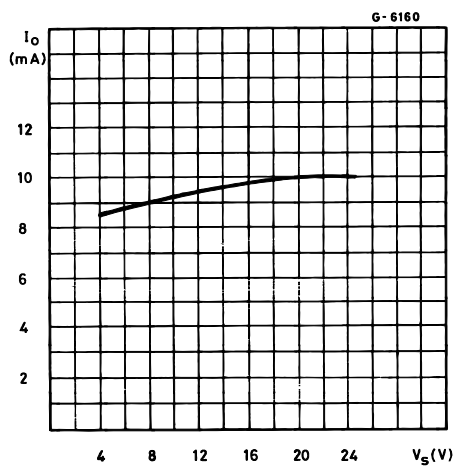

Figure 2 : Open Loop Gain vs. Frequency

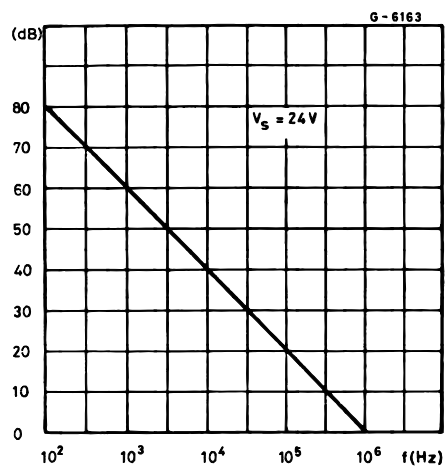

Figure 3 : Common Mode Rejection Frequency

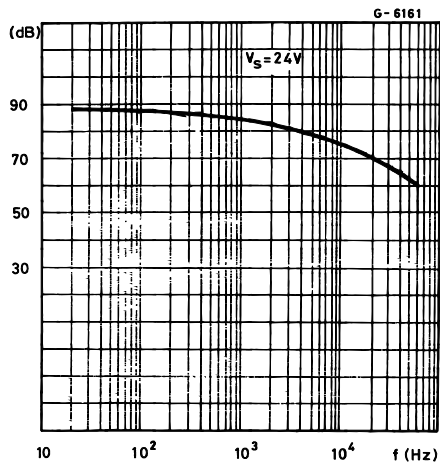

Figure 4 : Output Swing vs. Load Current ($V_S = \pm 5V$)

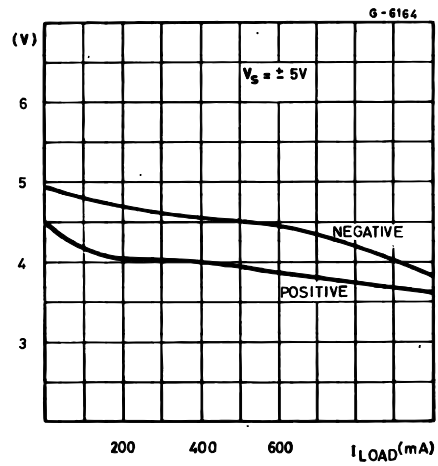

Figure 5 : Output Swing vs. Load Current ($V_S = \pm 12V$)

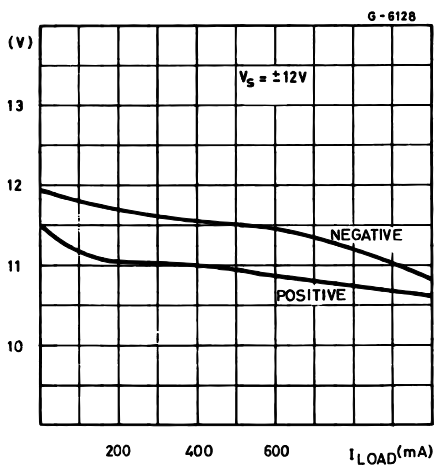

Figure 6 : Supply Voltage Rejection vs. Frequency

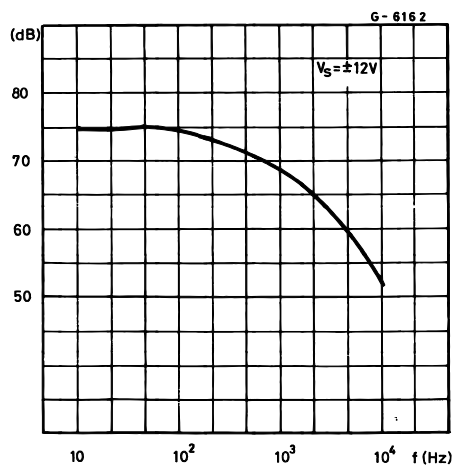
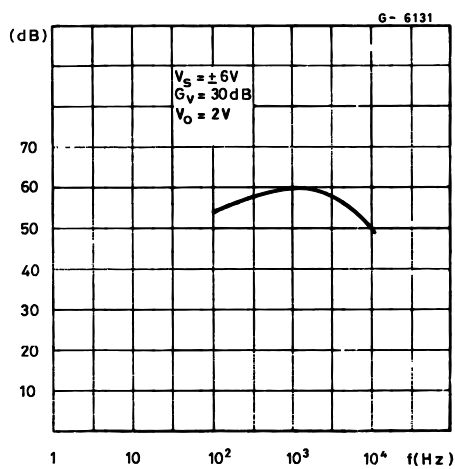
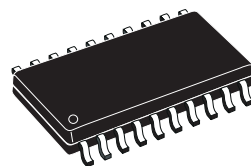

Figure 7 : Channel Separation vs. Frequency.



DIM.	mm			inch		
	MIN.	TYP.	MAX.	MIN.	TYP.	MAX.
A	2.35		2.65	0.093		0.104
A1	0.1		0.3	0.004		0.012
B	0.33		0.51	0.013		0.020
C	0.23		0.32	0.009		0.013
D	12.6		13	0.496		0.512
E	7.4		7.6	0.291		0.299
e		1.27			0.050	
H	10		10.65	0.394		0.419
h	0.25		0.75	0.010		0.030
L	0.4		1.27	0.016		0.050
K	0° (min.)8° (max.)					

OUTLINE AND MECHANICAL DATA



SO20

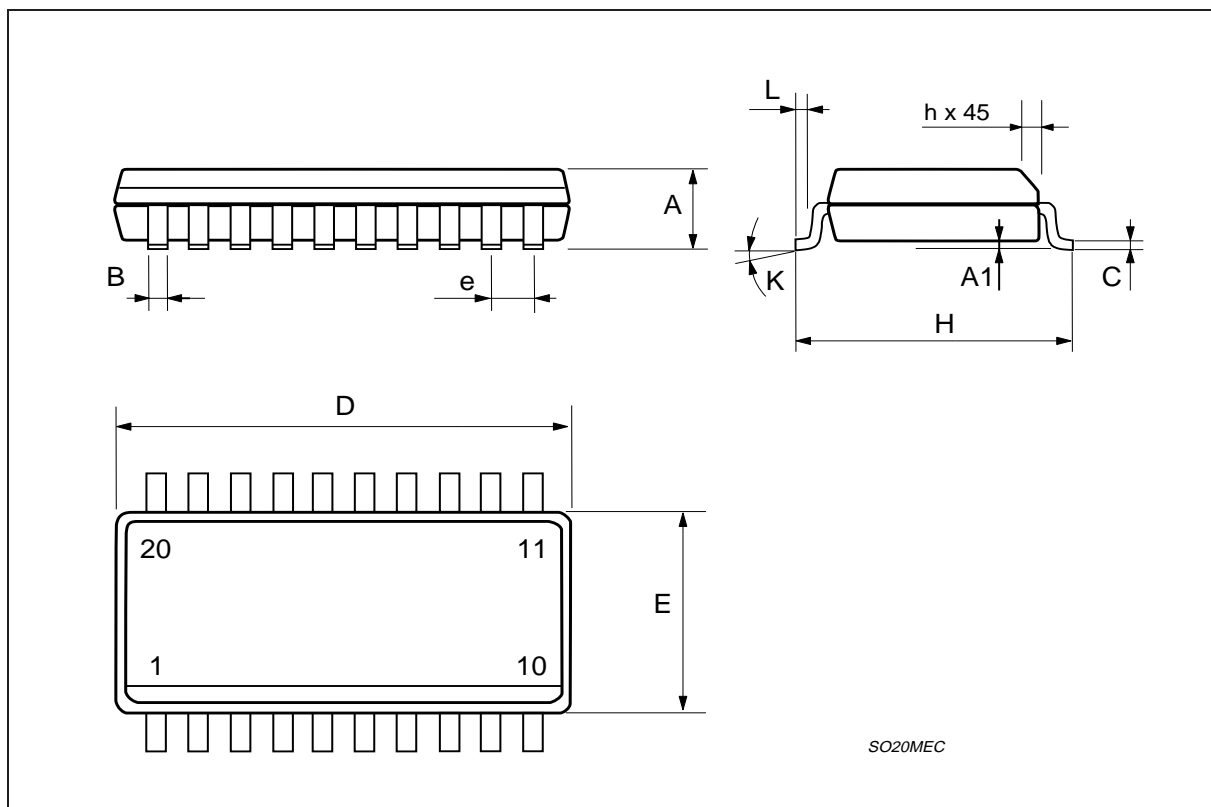

Information furnished is believed to be accurate and reliable. However, STMicroelectronics assumes no responsibility for the consequences of use of such information nor for any infringement of patents or other rights of third parties which may result from its use. No license is granted by implication or otherwise under any patent or patent rights of STMicroelectronics. Specification mentioned in this publication are subject to change without notice. This publication supersedes and replaces all information previously supplied. STMicroelectronics products are not authorized for use as critical components in life support devices or systems without express written approval of STMicroelectronics.



The ST logo is a registered trademark of STMicroelectronics
© 1998 STMicroelectronics – Printed in Italy – All Rights Reserved
STMicroelectronics GROUP OF COMPANIES

Australia - Brazil - Canada - China - France - Germany - Italy - Japan - Korea - Malaysia - Malta - Mexico - Morocco - The Netherlands -
Singapore - Spain - Sweden - Switzerland - Taiwan - Thailand - United Kingdom - U.S.A.

<http://www.st.com>

Looking for pricing, stock, or lifecycle information?

Click below to explore more details on WIN SOURCE:

-  [View L2726 on WIN SOURCE](#)
-  [STMicroelectronics Information](#)

Optimize Your Supply Chain with WIN SOURCE Solutions

-  Global Sourcing Solution
-  Obsolete Management
-  Cost Control Management
-  Shortage Management
-  Alternative Solution
-  Excess Inventory Management