



THE DATASHEET OF L03S400D15



Hall Effect Current Sensors L03S***D15 Series



Features:

- Open Loop type
- Panel mounting
- Molex connector
- Insulated plastic case according to UL94V0

Advantage:

- Excellent accuracy and linearity
- Low temperature drift
- Wide frequency bandwidth
- No insertion loss
- High Immunity To External Interference
- Current overload capability

Specifications

$T_A=25^{\circ}\text{C}$, $V_{CC}=\pm 15\text{V}$, $R_L=10\text{k}\Omega$

Parameters	Symbol	L03S050D15	L03S100D15	L03S200D15	L03S300D15	L03S400D15	L03S500D15	L03S600D15
Rated current	I_f	50AT	100AT	200AT	300AT	400AT	500AT	600AT
Maximum Current	I_{fmax}	$\pm 150\text{AT}$	$\pm 300\text{AT}$	$\pm 600\text{AT}$	$> \pm 700\text{AT}$			
Output Voltage	V_{OUT}	$4\text{V} \pm 40\text{mV} @ I_f$						
Offset Voltage	V_{OE}	$\leq \pm 40\text{mV} @ I_f = 0\text{A}$	$\leq \pm 30\text{mV} @ I_f = 0\text{A}$					
Accuracy ¹	X	$\pm 1\% @ I_f$						
Output Linearity ¹	ϵ_L	$\leq \pm 1\% @ I_f$						
Power Supply	V_{CC}	$\pm 15\text{V} \pm 5\%$						
Consumption Current	I_C	$< 12\text{mA}$						
Response Time ²	t_r	$< 5\mu\text{s} (@ di/dt=50\text{A} / \mu\text{s})$						
Output Temperature Characteristic ¹	TCV_{OUT}	$\leq \pm 2\text{mV}/^{\circ}\text{C}$						
Offset Temperature Characteristic	TCV_{OE}	$< \pm 2\text{mV}/^{\circ}\text{C}$	$< \pm 1.0\text{mV}/^{\circ}\text{C}$					
Hysteresis error	V_{OH}	$\pm 30\text{mV} (@ 0\text{A} \leftrightarrow I_f)$			$\pm 20\text{mV} (@ 0\text{A} \leftrightarrow I_f)$		$\pm 10\text{mV} (@ 0\text{A} \leftrightarrow I_f)$	
Withstand Voltage	V_d	AC2500V for 1minute (sensing current 0.5mA), inside of through hole \leftrightarrow terminal						
Insulation Resistance	R_{IS}	$> 500\text{M}\Omega$ (500V DC), inside of through hole \leftrightarrow terminal						
Frequency Bandwidth ³	f	DC .. 50kHz						
Operating Temperature	T_A	$-20^{\circ}\text{C} \sim +80^{\circ}\text{C}$						
Storage Temperature	T_S	$-20^{\circ}\text{C} \sim +85^{\circ}\text{C}$						

¹ Without offset — ² Time between 10% input current full scale and 90% of sensor output full scale — ³ Small signal only to avoid excessive heating of magnetic core

Electrical Performances

Frequency Characteristic (L03S600D15)

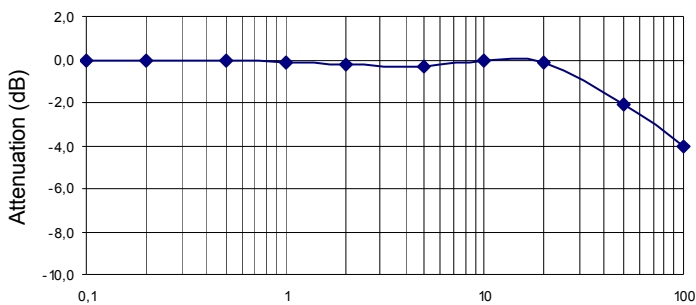

Saturation Characteristic (L03S600D15)

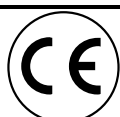
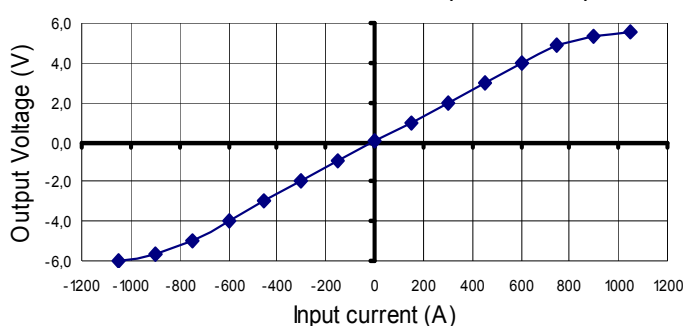

Hall Effect Current Sensors L03S***D15 Series

Mechanical dimensions in mm

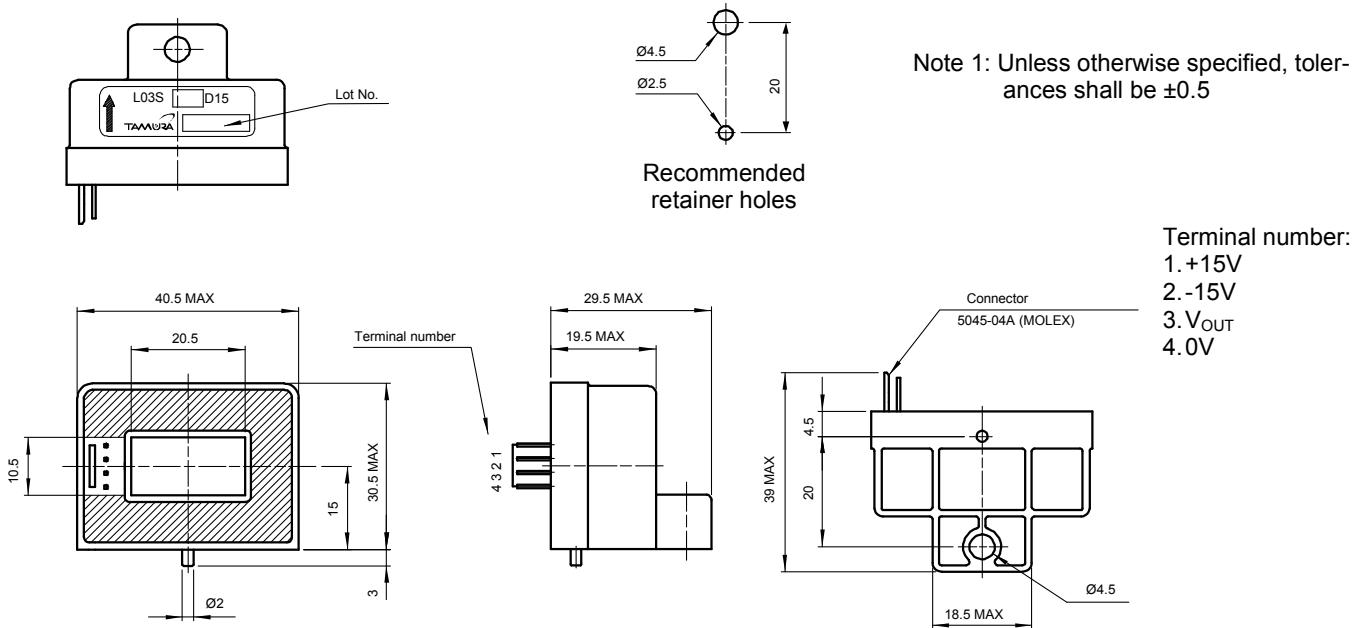

Electrical connection diagram

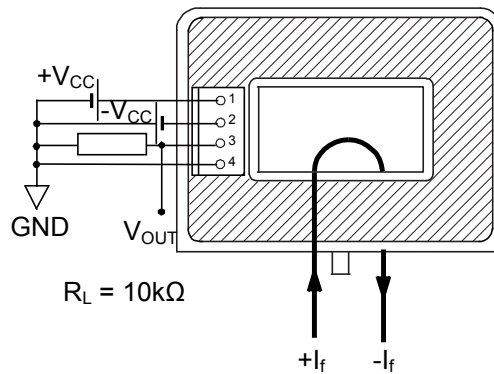



Package & Weight Information

Weight	Pcs/box	Pcs/carton	Pcs/pallet
46g	50	200	2400

Looking for pricing, stock, or lifecycle information?

Click below to explore more details on WIN SOURCE:

-  [View L03S400D15 on WIN SOURCE](#)
-  [Tamura Information](#)

Optimize Your Supply Chain with WIN SOURCE Solutions

-  Global Sourcing Solution
-  Obsolete Management
-  Cost Control Management
-  Shortage Management
-  Alternative Solution
-  Excess Inventory Management