

General Description

The XA Zynq™ UltraScale+™ MPSoC family is based on the UltraScale™ MPSoC architecture. This family of products integrates a feature-rich 64-bit quad-core Arm® Cortex™-A53 and dual-core Arm Cortex-R5 based processing system (PS) and programmable logic (PL) UltraScale architecture in a single device. Also included are on-chip memory, multiport external memory interfaces, and a rich set of peripheral connectivity interfaces.

Processing System (PS)

Arm Cortex-A53 Based Application Processing Unit (APU)

- Quad-core
- CPU frequency: Up to 1.2GHz
- Extendable cache coherency
- Armv8-A Architecture
 - 64-bit or 32-bit operating modes
 - TrustZone security
 - A64 instruction set in 64-bit mode, A32/T32 instruction set in 32-bit mode
- NEON Advanced SIMD media-processing engine
- Single/double precision Floating Point Unit (FPU)
- CoreSight™ and Embedded Trace Macrocell (ETM)
- Accelerator Coherency Port (ACP)
- AXI Coherency Extension (ACE)
- Power island gating for each processor core
- Timer and Interrupts
 - Arm Generic timers support
 - Two system level triple-timer counters
 - One watchdog timer
 - One global system timer
- Caches
 - 32KB Level 1, 2-way set-associative instruction cache with parity (independent for each CPU)
 - 32KB Level 1, 4-way set-associative data cache with ECC (independent for each CPU)
 - 1MB 16-way set-associative Level 2 cache with ECC (shared between the CPUs)

Dual-core Arm Cortex-R5 Based Real-Time Processing Unit (RPU)

- CPU frequency: Up to 500MHz
- Armv7-R Architecture
 - A32/T32 instruction set
- Single/double precision Floating Point Unit (FPU)
- CoreSight and Embedded Trace Macrocell (ETM)
- Lock-step or independent operation
- Timer and Interrupts:
 - One watchdog timer
 - Two triple-timer counters
- Caches and Tightly Coupled Memories (TCMs)
 - 32KB Level 1, 4-way set-associative instruction and data cache with ECC (independent for each CPU)
 - 128KB TCM with ECC (independent for each CPU) that can be combined to become 256KB in lock-step mode

On-Chip Memory

- 256KB on-chip RAM (OCM) in PS with ECC
- Up to 27Mb on-chip RAM (UltraRAM) with ECC in PL
- Up to 21.1Mb on-chip RAM (block RAM) with ECC in PL
- Up to 9.1Mb on-chip RAM (distributed RAM) in PL

AMD Adaptive Computing is creating an environment where employees, customers, and partners feel welcome and included. To that end, we're removing noninclusive language from our products and related collateral. We've launched an internal initiative to remove language that could exclude people or reinforce historical biases, including terms embedded in our software and IPs. You may still find examples of non-inclusive language in our older products as we work to make these changes and align with evolving industry standards. Follow this [link](#) for more information.

Arm Mali-400 Based GPU

- Supports OpenGL ES 1.1 and 2.0
- Supports OpenVG 1.1
- GPU frequency: Up to 600MHz
- Single Geometry Processor, Two Pixel Processors
- Vertex processing: 66 M Triangles/s
- Pixel processing: 1.2 G Pixels/s
- 64KB L2 Cache
- Power island gating

External Memory Interfaces

- Multi-protocol dynamic memory controller
- 32-bit or 64-bit interfaces to DDR4, DDR3, DDR3L, or LPDDR3 memories, and 32-bit interface to LPDDR4 memory
- ECC support in 64-bit and 32-bit modes
- Up to 32GB of address space using single or dual rank of 8-, 16-, or 32-bit-wide memories
- Static memory interfaces
 - eMMC4.51 Managed NAND flash support
 - ONFI3.1 NAND flash with 24-bit ECC
 - 1-bit SPI, 2-bit SPI, 4-bit SPI (Quad-SPI), or two Quad-SPI (8-bit) serial NOR flash

8-Channel DMA Controller

- Two DMA controllers of 8-channels each
- Memory-to-memory, memory-to-peripheral, peripheral-to-memory, and scatter-gather transaction support

Serial Transceivers

- Four dedicated PS-GTR receivers and transmitters supports up to 6.0Gb/s data rates
 - Supports SGMII tri-speed Ethernet, PCI Express® Gen2, Serial-ATA (SATA), USB3.0, and DisplayPort

Dedicated I/O Peripherals and Interfaces

- PCI Express — Compliant with PCIe 2.1 base specification
 - Root complex and End Point configurations
 - x1, x2, and x4 at Gen1 or Gen2 rates
- SATA Host
 - 1.5, 3.0, and 6.0Gb/s data rates as defined by SATA Specification, revision 3.1
 - Supports up to two channels
- DisplayPort Controller
 - Up to 5.4Gb/s rate
 - Up to two TX lanes (no RX support)

- Four 10/100/1000 tri-speed Ethernet MAC peripherals with IEEE Std 802.3 and IEEE Std 1588 revision 2.0 support
 - Scatter-gather DMA capability
 - Recognition of IEEE Std 1588 rev.2 PTP frames
 - GMII, RGMII, and SGMII interfaces
 - Jumbo frames
- Two USB 3.0/2.0 Device, Host, or OTG peripherals, each supporting up to 12 endpoints
 - USB 3.0/2.0 compliant device IP core
 - Super-speed, high-speed, full-speed, and low-speed modes
 - Intel XHCI-compliant USB host
- Two full CAN 2.0B-compliant CAN bus interfaces
 - CAN 2.0-A and CAN 2.0-B and ISO 118981-1 standard compliant
- Two SD/SDIO 2.0/eMMC4.51 compliant controllers
- Two full-duplex SPI ports with three peripheral chip selects
- Two high-speed UARTs (up to 1Mb/s)
- Two master and slave I2C interfaces
- Up to 78 flexible multiplexed I/O (MIO) (up to three banks of 26 I/Os) for peripheral pin assignment
- Up to 96 EMIOs (up to three banks of 32 I/Os) connected to the PL

Interconnect

- High-bandwidth connectivity within PS and between PS and PL
- Arm AMBA® AXI4-based
- QoS support for latency and bandwidth control
- Cache Coherent Interconnect (CCI)

System Memory Management

- System Memory Management Unit (SMMU)
- Xilinx® Memory Protection Unit (XMPU)

Platform Management Unit

- Power gates PS peripherals, power islands, and power domains
- Clock gates PS peripheral user firmware option

Configuration and Security Unit

- Boots PS and configures PL
- Supports secure and non-secure boot modes

System Monitor in PS

- On-chip voltage and temperature sensing

Programmable Logic (PL)

Configurable Logic Blocks (CLB)

- Look-up tables (LUT)
- Flip-flops
- Cascadable adders

36Kb Block RAM

- True dual-port
- Up to 72 bits wide
- Configurable as dual 18Kb

UltraRAM

- 288Kb dual-port
- 72 bits wide
- Error checking and correction

DSP Blocks

- 27 x 18 signed multiply
- 48-bit adder/accumulator
- 27-bit pre-adder

Programmable I/O Blocks

- Supports LVCMOS, LVDS, and SSTL
- 1.0V to 3.3V I/O
- Programmable I/O delay and SerDes

JTAG Boundary-Scan

- IEEE Std 1149.1 Compatible Test Interface

PCI Express

- Supports Root complex and End Point configurations
- Supports up to Gen3 speeds
- Up to two integrated blocks in select devices
 - Note: XAZU11EG can support up to 4 PCIe Gen 3x8 or 2 PCIe Gen3x16

Video Encoder/Decoder (VCU)

- Available in EV devices
- Accessible from either PS or PL
- Simultaneous encode and decode
- H.264 and H.265 support

System Monitor in PL

- On-chip voltage and temperature sensing
- 10-bit 200KSPS ADC with up to 17 external inputs

Feature Summary

Table 1: XA Zynq UltraScale+ MPSoC: EG Device Feature Summary

	XAZU1EG	XAZU2EG	XAZU3EG	XAZU3TEG	XAZU11EG
Application Processing Unit	Quad-core Arm Cortex-A53 MPCore with CoreSight; NEON & Single/Double Precision Floating Point; 32KB/32KB L1 Cache, 1MB L2 Cache				
Real-Time Processing Unit	Dual-core Arm Cortex-R5 with CoreSight; Single/Double Precision Floating Point; 32KB/32KB L1 Cache, and TCM				
Embedded and External Memory	256KB On-Chip Memory w/ECC; External DDR4; DDR3; DDR3L; LPDDR4; LPDDR3; External Quad-SPI; NAND; eMMC				
General Connectivity	214 PS I/O; UART; CAN; USB 2.0; I2C; SPI; 32b GPIO; Real Time Clock; WatchDog Timers; Triple Timer Counters				
High-Speed Connectivity	4 PS-GTR; PCIe Gen1/2; Serial ATA 3.1; DisplayPort 1.2a; USB 3.0; SGMII				
Graphic Processing Unit	Arm Mali™-400 MP2; 64KB L2 Cache				
System Logic Cells	81,900	103,320	154,350	157,500	653,100
CLB Flip-Flops	74,880	94,464	141,120	144,000	597,120
CLB LUTs	37,440	47,232	70,560	72,000	298,560
Distributed RAM (Mb)	1.0	1.2	1.8	2.1	9.1
Block RAM Blocks	108	150	216	144	600
Block RAM (Mb)	3.8	5.3	7.6	14.0	21.1
UltraRAM Blocks	0	0	0	48	80
UltraRAM (Mb)	0	0	0	14.0	22.5
DSP Slices	216	240	360	576	2,928
CMTs	3	3	3	1	8
Max. HP I/O ⁽¹⁾	156	156	156	52	416
Max. HD I/O ⁽²⁾	24	96	96	72	48
System Monitor	2	2	2	2	2
GTH Transceiver 12.5Gb/s	0	0	0	8	32
Transceiver Fractional PLLs	0	0	0	4	16
PCIe Gen3 x16	0	0	0	0	2
PCIe Gen3 x8	0	0	0	0	4

Notes:

1. HP = High-performance I/O with support for I/O voltage from 1.0V to 1.8V.
2. HD = High-density I/O with support for I/O voltage from 1.2V to 3.3V.

Table 2: XA Zynq UltraScale+ MPSoC: EG Device-Package Combinations and Maximum I/Os

Package (1)(3)(4)	Package Dimensions (mm)	XAZU1EG	XAZU2EG	XAZU3EG	XAZU3TEG	XAZU11EG
		HD, HP, GTH	HD, HP, GTH	HD, HP, GTH	HD, HP, GTH	HD, HP, GTH
SBVA484 ⁽⁵⁾	19x19	24, 58, 0	24, 58, 0	24, 58, 0		
SFVA625	21x21	24, 156, 0	24, 156, 0	24, 156, 0		
SFVC784	28x28	24, 156, 0	96, 156, 0	96, 156, 0	214, 72, 52	
SFVD784	28x28				214, 72, 52	
FFVF1517	40x40					48, 416, 32

Notes:

1. Go to [Ordering Information](#) for package designation details.
2. FF packages have 1.0mm ball pitch. SB and SF packages have 0.8mm ball pitch.
3. All device package combinations bond out 4 PS-GTR transceivers.
4. All device package combinations bond out 214 PS I/O except ZU1EG, ZU2EG, and ZU3EG in the SBVA484 and SFVA625 packages, which bond out 170 PS I/Os.
5. All 58 HP I/O pins are powered by the same V_{CCO} supply.

Table 3: XA Zynq UltraScale+ MPSoC: EV Device Feature Summary

	XAZU4EV	XAZU5EV	XAZU7EV
Application Processing Unit	Quad-core Arm Cortex-A53 MPCore with CoreSight; NEON & Single/Double Precision Floating Point; 32KB/32KB L1 Cache, 1MB L2 Cache		
Real-Time Processing Unit	Dual-core Arm Cortex-R5 with CoreSight; Single/Double Precision Floating Point; 32KB/32KB L1 Cache, and TCM		
Embedded and External Memory	256KB On-Chip Memory w/ECC; External DDR4; DDR3; DDR3L; LPDDR4; LPDDR3; External Quad-SPI; NAND; eMMC		
General Connectivity	214 PS I/O; UART; CAN; USB 2.0; I2C; SPI; 32b GPIO; Real Time Clock; WatchDog Timers; Triple Timer Counters		
High-Speed Connectivity	4 PS-GTR; PCIe Gen1/2; Serial ATA 3.1; DisplayPort 1.2a; USB 3.0; SGMII		
Graphic Processing Unit	Arm Mali™-400 MP2; 64KB L2 Cache		
Video Codec	1	1	1
System Logic Cells	192,150	256,200	504,000
CLB Flip-Flops	175,680	234,240	460,800
CLB LUTs	87,840	117,120	230,400
Distributed RAM (Mb)	2.6	3.5	6.2
Block RAM Blocks	128	144	312
Block RAM (Mb)	4.5	5.1	11.0
UltraRAM Blocks	48	64	96
UltraRAM (Mb)	13.5	18.0	27.0
DSP Slices	728	1,248	1,728
CMTs	4	4	8
Max. HP I/O ⁽¹⁾	156	156	156
Max. HD I/O ⁽²⁾	96	96	48
System Monitor	2	2	2
GTH Transceiver 12.5Gb/s	4	4	16
Transceiver Fractional PLLs	2	2	8
PCIe Gen3 x16	2	2	2

Notes:

1. HP = High-performance I/O with support for I/O voltage from 1.0V to 1.8V.
2. HD = High-density I/O with support for I/O voltage from 1.2V to 3.3V.

Table 4: XA Zynq UltraScale+ MPSoC: EV Device-Package Combinations and Maximum I/Os

Package ⁽¹⁾⁽²⁾	Package Dimensions (mm)	XAZU4EV	XAZU5EV	XAZU7EV
		HD, HP, GTH	HD, HP, GTH	HD, HP, GTH
SFVC784	23x23	96, 156, 4	96, 156, 4	
FBVB900	31x31			48, 156, 16

Notes:

1. Go to [Ordering Information](#) for package designation details.
2. All device package combinations bond out 4 PS-GTR transceivers.

Zynq UltraScale+ MPSoCs

A comprehensive device family, Zynq UltraScale+ MPSoCs offer single-chip, all programmable, heterogeneous multiprocessors that provide designers with software, hardware, interconnect, power, security, and I/O programmability. The range of devices in the Zynq UltraScale+ MPSoC family allows designers to target cost-sensitive as well as high-performance applications from a single platform using industry-standard tools. While each Zynq UltraScale+ MPSoC contains the same PS, the PL, Video hard blocks, and I/O resources vary between the devices.

Table 5: XA Zynq UltraScale+ MPSoC Device Features

	EG Devices	EV Devices
APU	Quad-core Arm Cortex-A53	Quad-core Arm Cortex-A53
RPU	Dual-core Arm Cortex-R5	Dual-core Arm Cortex-R5
GPU	Mali-400MP2	Mali-400MP2
VCU	–	H.264/H.265

XA Zynq UltraScale+ MPSoCs are able to serve a wide range of Automotive applications including multi-camera multi-feature driver assistance systems, high resolution and video graphic infotainment systems, and driver information.

The UltraScale MPSoC architecture provides processor scalability from 32 to 64 bits with support for virtualization, the combination of soft and hard engines for real-time control, graphics/video processing, waveform and packet processing, next-generation interconnect and memory, advanced power management, and technology enhancements that deliver multi-level security, safety, and reliability. A large number of soft IP are available for the XA Zynq UltraScale+ MPSoC family. Stand-alone and Linux device drivers are available for the peripherals in the PS and the PL. Vivado™ Design Suite, SDK™, and PetaLinux development environments enable rapid product development for software, hardware, and systems engineers. The Arm-based PS also brings a broad range of third-party tools and IP providers in combination with our existing PL ecosystem.

The XA Zynq UltraScale+ MPSoC family delivers unprecedented processing, I/O, and memory bandwidth in the form of an optimized mix of heterogeneous processing engines embedded in a next-generation, high-performance, on-chip interconnect with appropriate on-chip memory subsystems. The heterogeneous processing and programmable engines, which are optimized for different application tasks, enable the XA Zynq UltraScale+ MPSoC to deliver the extensive performance and efficiency required to address next-generation smarter systems while retaining backwards compatibility with the original XA Zynq 7000 All Programmable SoC family. The UltraScale MPSoC architecture also incorporates multiple levels of security, increased safety, and advanced power management, which are critical requirements of next-generation smarter systems. Our embedded UltraFast™ design methodology fully exploits the ASIC-class capabilities afforded by the UltraScale MPSoC architecture while supporting rapid system development.

The inclusion of an application processor enables high-level operating system support (e.g., AutoSAR and Linux). Other standard operating systems used with the Cortex-A53 processor are also available for the XA Zynq UltraScale+ MPSoC family. The PS and the PL are on separate power domains, enabling users to power down the PL for power management if required. The processors in the PS always boot first, allowing a software centric approach for PL configuration. PL configuration is managed by software running on the CPU, so it boots similar to an ASSP.

Processing System

Application Processing Unit (APU)

The key features of the APU include:

- 64-bit quad-core Arm Cortex-A53 MPCores. Features associated with each core include:
 - Arm v8-A Architecture
 - Operating target frequency: up to 1.2GHz
 - Single and double precision floating point:
4 SP/2 DP FLOPS/MHz
 - NEON Advanced SIMD support with single and double precision floating point instructions
 - A64 instruction set in 64-bit operating mode, A32/T32 instruction set in 32-bit operating mode
 - Level 1 cache (separate instruction and data, 32KB each for each Cortex-A53 CPU)
 - 2-way set-associative Instruction Cache with parity support
 - 4-way set-associative Data Cache with ECC support
 - Integrated memory management unit (MMU) per processor core
 - TrustZone for secure mode operation
 - Virtualization support
- Ability to operate in single processor, symmetric quad processor, and asymmetric quad-processor modes
- Integrated 16-way set-associative 1MB Unified Level 2 cache with ECC support
- Interrupts and Timers
 - Generic interrupt controller (GIC-400)
 - Arm generic timers (4 timers per CPU)
 - One watchdog timer (WDT)
 - One global timer
 - Two triple timers/counters (TTC)
- CoreSight debug and trace support
 - Embedded Trace Macrocell (ETM) for instruction trace
 - Cross trigger interface (CTI) enabling hardware breakpoints and triggers
- ACP interface to PL for I/O coherency and Level 2 cache allocation
- ACE interface to PL for full coherency
- Power island gating on each processor core
- Optional eFUSE disable per core

Real-Time Processing Unit (RPU)

- Dual-core Arm Cortex-R5 MPCores. Features associated with each core include:
 - Arm v7-R Architecture (32-bit)
 - Operating target frequency: Up to 500MHz
 - A32/T32 instruction set support
 - 4-way set-associative Level 1 caches (separate instruction and data, 32KB each) with ECC support
 - Integrated Memory Protection Unit (MPU) per processor
 - 128KB Tightly Coupled Memory (TCM) with ECC support
 - TCMs can be combined to become 256KB in lockstep mode
- Ability to operate in single-processor or dual-processor modes (split and lock-step)
- Dedicated SWDT and two Triple Timer Counters (TTC)
- CoreSight debug and trace support
 - Embedded Trace Macrocell (ETM) for instruction and trace
 - Cross trigger interface (CTI) enabling hardware breakpoints and triggers
- Optional eFUSE disable

Full-Power Domain DMA (FPD-DMA) and Low-Power Domain DMA (LPD-DMA)

- Two general-purpose DMA controllers one in the full-power domain (FPD-DMA) and one in the low-power domain (LPD-DMA)
- Eight independent channels per DMA
- Multiple transfer types:
 - Memory-to-memory
 - Memory-to-peripheral
 - Peripheral-to-memory and
 - Scatter-gather
- 8 peripheral interfaces per DMA
- TrustZone per DMA for optional secure operation

Xilinx Memory Protection Unit (XMPU)

- Region based memory protection unit
- Up to 16 regions
- Each region supports address alignment of 1MB or 4KB
- Regions can overlap; the higher region number has priority
- Each region can be independently enabled or disabled
- Each region has a start and end address

Graphics Processing Unit (GPU)

- Supports OpenGL ES 1.1 & 2.0
- Supports OpenVG 1.1
- Operating target frequency: up to 600MHz
- Single Geometry Processor and two Pixel processor
- Vertex processing: 66 M Triangles/s
- Pixel processing: 1.2 G Pixels/s
- 64KB Level 2 Cache (read-only)
- 4X and 16X Anti-aliasing Support
- ETC texture compression to reduce external memory bandwidth
- Extensive texture format support
 - RGBA 8888, 565, 1556
 - Mono 8, 16
 - YUV format support
- Automatic load balancing across different graphics shader engines
- 2D and 3D graphic acceleration with performance scalable up to 1080p resolutions
- Each geometry processor and pixel processor supports 4KB page MMU
- Power island gating on each GPU engine and shared cache
- Optional eFUSE disable

Dynamic Memory Controller (DDRC)

- DDR3, DDR3L, DDR4, LPDDR3, LPDDR4
- Target data rate: Up to 2,400Mb/s DDR4 operation in -1 speed grade
- 32-bit and 64-bit bus width support for DDR4, DDR3, DDR3L, or LPDDR3 memories, and 32-bit bus width support for LPDDR4 memory
- ECC support (using extra bits)
- Up to a total DRAM capacity of 32GB

- Low power modes
 - Active/precharge power down
 - Self-refresh, including clean exit from self-refresh after a controller power cycle
- Enhanced DDR training by allowing software to measure read/write eye and make delay adjustments dynamically
- Independent performance monitors for read path and write path
- Integration of PHY Debug Access Port (DAP) into JTAG for testing

The DDR memory controller is multi-ported and enables the PS and the PL to have shared access to a common memory. The DDR controller features six AXI slave ports for this purpose:

- Two 128-bit AXI ports from the Arm Cortex-A53 CPU(s), RPU (Arm Cortex-R5 and LPD peripherals), GPU, high speed peripherals (USB3, PCIe & SATA), and High Performance Ports (HP0 & HP1) from the PL through the Cache Coherent Interconnect (CCI)
- One 64-bit port is dedicated for the Arm Cortex-R5 CPU(s)
- One 128-bit AXI port from the DisplayPort and HP2 port from the PL
- One 128-bit AXI port from HP3 and HP4 ports from the PL
- One 128-bit AXI port from General DMA and HP5 from the PL

High-Speed Connectivity Peripherals

PCIe

- Compliant with the PCI Express Base Specification 2.1
- Fully compliant with PCI Express transaction ordering rules
- Lane width: x1, x2, or x4 at Gen1 or Gen2 rates
- 1 Virtual Channel
- Full duplex PCIe port
- End Point and single PCIe link Root Port
- Root Port supports Enhanced Configuration Access Mechanism (ECAM), Cfg Transaction generation
- Root Port support for INTx, and MSI
- Endpoint support for MSI or MSI-X
 - 1 physical function, no SR-IOV
 - No relaxed or ID ordering
 - Fully configurable BARs
 - INTx not recommended, but can be generated
 - Endpoint to support configurable target/slave apertures with address translation and Interrupt capability

SATA

- Compliant with SATA 3.1 Specification
- SATA host port supports up to 2 external devices
- Compliant with Advanced Host Controller Interface ('AHCI') ver. 1.3
- 1.5Gb/s, 3.0Gb/s, and 6.0Gb/s data rates
- Power management features: supports partial and slumber modes

USB 3.0

- Two USB controllers (configurable as USB 2.0 or USB 3.0)
- Up to 5.0Gb/s data rate
- Host and Device modes
 - Super Speed, High Speed, Full Speed, and Low Speed
 - Up to 12 endpoints
 - The USB host controller registers and data structures are compliant to Intel xHCI specifications
 - 64-bit AXI master port with built-in DMA
 - Power management features: Hibernation mode

DisplayPort Controller

- 4K Display Processing with DisplayPort output
 - Maximum resolution of 4K x 2K-30 (30Hz pixel rate)
 - DisplayPort AUX channel, and Hot Plug Detect (HPD) on the output
 - RGB YCbCr, 4:2:0; 4:2:2, 4:4:4 with 6, 8, 10, and 12b/c
 - Y-only, xvYCC, RGB 4:4:4, YCbCr 4:4:4, YCbCr 4:2:2, and YCbCr 4:2:0 video format with 6,8,10 and 12-bits per color component
 - 256-color palette
 - Multiple frame buffer formats
 - 1, 2, 4, 8 bits per pixel (bpp) via a palette
 - 16, 24, 32bpp
 - Graphics formats such as RGBA8888, RGB555, etc.
- Accepts streaming video from the PL or dedicated DMA controller
- Enables Alpha blending of graphics and Chroma keying

- Audio support
 - A single stream carries up to 8 LPCM channels at 192kHz with 24-bit resolution
 - Supports compressed formats including DRA, Dolby MAT, and DTS HD
 - Multi-Stream Transport can extend the number of audio channels
 - Audio copy protection
 - 2-channel streaming or input from the PL
 - Multi-channel non-streaming audio from a memory audio frame buffer
- Includes a System Time Clock (STC) compliant with ISO/IEC 13818-1
- Boot-time display using minimum resources

Platform Management Unit (PMU)

- Performs system initialization during boot
- Acts as a delegate to the application and real-time processors during sleep state
- Initiates power-up and restart after the wake-up request
- Maintains the system power state at all time
- Manages the sequence of low-level events required for power-up, power-down, reset, clock gating, and power gating of islands and domains
- Provides error management (error handling and reporting)
- Provides safety check functions (e.g., memory scrubbing)

The PMU includes the following blocks:

- Platform management processor
- Fixed ROM for boot-up of the device
- 128KB RAM with ECC for optional user/firmware code
- Local and global registers to manage power-down, power-up, reset, clock gating, and power gating requests
- Interrupt controller with 16 interrupts from other modules and the inter-processor communication interface (IPI)
- GPI and GPO interfaces to and from PS I/O and PL
- JTAG interface for PMU debug
- Optional User-Defined Firmware

Configuration Security Unit (CSU)

- Triple redundant Secure Processor Block (SPB) with built-in ECC
- Crypto Interface Block consisting of
 - 256-bit AES-GCM
 - SHA-3/384
 - 4,096-bit RSA
- Key Management Unit
- Built-in DMA
- PCAP interface
- Supports ROM validation during pre-configuration stage
- Loads First Stage Boot Loader (FSBL) into OCM in either secure or non-secure boot modes
- Supports voltage, temperature, and frequency monitoring after configuration

Xilinx Peripheral Protection Unit (XPPU)

- Provides peripheral protection support
- Up to 20 masters simultaneously
- Multiple aperture sizes
- Access control for a specified set of address apertures on a per master basis
- 64KB peripheral apertures and controls access on per peripheral basis

I/O Peripherals

The IOP unit contains the data communication peripherals. Key features of the IOP include:

Triple-Speed Gigabit Ethernet

- Compatible with IEEE Std 802.3 and supports 10/100/1,000Mb/s transfer rates (Full and Half duplex)
- Supports jumbo frames
- Built-in Scatter-Gather DMA capability
- Statistics counter registers for RMON/MIB
- Multiple I/O types (1.8, 2.5, 3.3V) on RGMII interface with external PHY
- GMII interface to PL to support interfaces as: TBI, SGMII, and RGMII v2.0 support
- Automatic pad and cyclic redundancy check (CRC) generation on transmitted frames
- Transmitter and Receive IP, TCP, and UDP checksum offload
- MDIO interface for physical layer management

- Full duplex flow control with recognition of incoming pause frames and hardware generation of transmitted pause frames
- 802.1Q VLAN tagging with recognition of incoming VLAN and priority tagged frames
- Supports IEEE Std 1588 v2

SD/SDIO 3.0 Controller

In addition to secure digital (SD) devices, this controller also supports eMMC 4.51.

- Host mode support only
- Built-in DMA
- 1/4-Bit SD Specification, version 3.0
- 1/4/8-Bit eMMC Specification, version 4.51
- Supports primary boot from SD Card and eMMC (Managed NAND)
- High speed, default speed, and low-speed support
- 1 and 4-bit data interface support
 - Low-speed clock 0–400KHz
 - Default speed 0–25MHz
 - High speed clock 0–50MHz
- High-speed Interface
 - SD UHS-1: 208MHz
 - eMMC HS200: 200MHz
- Memory, I/O, and SD cards
- Power control modes
- Data FIFO interface up to 512B

UART

- Programmable baud rate generator
- 6, 7, or 8 data bits
- 1, 1.5, or 2 stop bits
- Odd, even, space, mark, or no parity
- Parity, framing, and overrun error detection
- Line break generation and detection
- Automatic echo, local loopback, and remote loopback channel modes
- Modem control signals: CTS, RTS, DSR, DTR, RI, and DCD (from EMIO only)

SPI

- Full-duplex operation offers simultaneous receive and transmit
- 128B deep read and write FIFO
- Master or slave SPI mode
- Up to 3 chip select lines
- Multi-master environment
- Identifies an error condition if more than one master detected
- Selectable master clock reference
- Software can poll for status or be interrupt driven

I2C

- 128-bit buffer size
- Both normal (100kHz) and fast bus data rates (400kHz)
- Master or slave mode
- Normal or extended addressing
- I2C bus hold for slow host service

GPIO

- Up to 128 GPIO bits
 - Up to 78-bits from MIO and 96-bits from EMIO
- Each GPIO bit can be dynamically programmed as input or output
- Independent reset values for each bit of all registers
- Interrupt request generation for each GPIO signals
- Single Channel (Bit) write capability for all control registers include data output register, direction control register, and interrupt clear register
- Read back in output mode

CAN

- Conforms to the ISO 11898 -1, CAN2.0A, and CAN 2.0B standards
- Both standard (11-bit identifier) and extended (29-bit identifier) frames
- Bit rates up to 1Mb/s
- Transmit and Receive message FIFO with a depth of 64 messages
- Watermark interrupts for TXFIFO and RXFIFO
- Automatic re-transmission on errors or arbitration loss in normal mode
- Acceptance filtering of 4 acceptance filters

- Sleep Mode with automatic wake-up
- Snoop Mode
- 16-bit time-stamping for receive messages
- Both internal generated reference clock and external reference clock input from MIO
- Guarantee clock sampling edge between 80 to 83% at 24MHz reference clock input
- Optional eFUSE disable per port

USB 2.0

- Two USB controllers (configurable as USB 2.0 or USB 3.0)
- Host, device and On-The-Go (OTG) modes
- High Speed, Full Speed, and Low Speed
- Up to 12 endpoints
- 8-bit ULPI External PHY Interface
- The USB host controller registers and data structures are compliant to Intel xHCI specifications.
- 64-bit AXI master port with built-in DMA
- Power management features: hibernation mode

Static Memory Interfaces

The static memory interfaces support external static memories.

- ONFI 3.1 NAND flash support with up to 24-bit ECC
- 1-bit SPI, 2-bit SPI, 4-bit SPI (Quad-SPI), or two Quad-SPI (8-bit) serial NOR flash
- 8-bit eMMC interface supporting managed NAND flash

NAND ONFI 3.1 Flash Controller

- ONFI 3.1 compliant
- Supports chip select reduction per ONFI 3.1 spec
- SLC NAND for boot/configuration and data storage
- ECC options based on SLC NAND
 - 1, 4, or 8 bits per 512+spare bytes
 - 24 bits per 1,024+spare bytes
- Max bandwidth as follows
 - Asynchronous mode (SDR) at 50MHz
 - Synchronous mode (NV-DDR) at 100MHz (200Mb/s)
- 8-bit SDR NAND interface

- 2 chip selects
- Programmable access timing
- 1.8V and 3.3V I/O
- Built-in DMA for improved performance

Quad-SPI Controller

- 4 bytes (32-bit) and 3 bytes (24-bit) address width
- Maximum SPI Clock at Master Mode at 150MHz
- Single, Dual-Parallel, and Dual-Stacked mode
- 32-bit AXI Linear Address Mapping Interface for read operation
- Up to 2 chip select signals
- Write Protection Signal
- Hold signals
- 4-bit bidirectional I/O signals
- x1/x2/x4 Read speed required
- x1 write speed required only
- 64 byte Entry FIFO depth to improve QSPI read efficiency
- Built-in DMA for improved performance

Video Encoder/Decoder (VCU)

Zynq UltraScale+ MPSoCs include a Video codec (encoder/decoder) available in the devices designated with the EV suffix. The VCU is located in the PL and can be accessed from either the PL or PS.

- Simultaneous Encode and Decode through separate cores
- H.264 high profile level 5.2 (4Kx2K-60)
- H.265 (HEVC) main, main10 profile, level 5.1, high Tier, up to 4Kx2K-60 rate
- 8 and 10 bit encoding
- 4:2:0 and 4:2:2 chroma sampling
- 8Kx4K-15 rate
- Multi-stream up to total of 4Kx2K-60 rate
- Low Latency mode
- Can share the PS DRAM or use dedicated DRAM in the PL
- Clock/power management

Interconnect

All the blocks are connected to each other and to the PL through a multi-layered Arm Advanced Microprocessor Bus Architecture (AMBA) AXI interconnect. The interconnect is non-blocking and supports multiple simultaneous master-slave transactions.

The interconnect is designed with latency sensitive masters, such as the Arm CPU, having the shortest paths to memory, and bandwidth critical masters, such as the potential PL masters, having high throughput connections to the slaves with which they need to communicate.

Traffic through the interconnect can be regulated through the Quality of Service (QoS) block in the interconnect. The QoS feature is used to regulate traffic generated by the CPU, DMA controller, and a combined entity representing the masters in the IOP.

PS Interfaces

PS interfaces include external interfaces going off-chip or signals going from PS to PL.

PS External Interfaces

The Zynq UltraScale+ MPSoC's external interfaces use dedicated pins that cannot be assigned as PL pins. These include:

- Clock, reset, boot mode, and voltage reference
- Up to 78 dedicated multiplexed I/O (MIO) pins, software-configurable to connect to any of the internal I/O peripherals and static memory controllers
- 32-bit or 64-bit DDR4/DDR3/DDR3L/LPDDR3 memories with optional ECC
- 32-bit LPDDR4 memory with optional ECC
- 4 channels (TX and RX pair) for transceivers

MIO Overview

The IOP peripherals communicate to external devices through a shared pool of up to 78 dedicated multiplexed I/O (MIO) pins. Each peripheral can be assigned one of several pre-defined groups of pins, enabling a flexible assignment of multiple devices simultaneously. Although 78 pins are not enough for simultaneous use of all the I/O peripherals, most IOP interface signals are available to the PL, allowing use of standard PL I/O pins when powered up and properly configured. Extended multiplexed I/O (EMIO) allows unmapped PS peripherals to access PL I/O.

Port mappings can appear in multiple locations. For example, there are up to 12 possible port mappings for CAN pins. The PS Configuration Wizard (PCW) tool aids in peripheral and static memory pin mapping.

Table 6: MIO Peripheral Interface Mapping

Peripheral Interface	MIO	EMIO
Quad-SPI NAND	Yes	No
USB2.0: 0,1	Yes: External PHY	No
SDIO 0,1	Yes	Yes
SPI: 0,1 I2C: 0,1 CAN: 0,1 GPIO	Yes CAN: External PHY GPIO: Up to 78 bits	Yes CAN: External PHY GPIO: Up to 96 bits
GigE: 0,1,2,3	RGMI v2.0: External PHY	Supports GMII, RGMII v2.0 (HSTL), RGMII v1.3, MII, SGMII, and 1000BASE-X in Programmable Logic
UART: 0,1	Simple UART: Only two pins (TX and RX)	Full UART (TX, RX, DTR, DCD, DSR, RI, RTS, and CTS) requires either: <ul style="list-style-type: none"> Two Processing System (PS) pins (RX and TX) through MIO and six additional Programmable Logic (PL) pins, <i>or</i> Eight Programmable Logic (PL) pins
Debug Trace Ports	Yes: Up to 16 trace bits	Yes: Up to 32 trace bits
Processor JTAG	Yes	Yes

Transceiver (PS-GTR)

The four PS-GTR transceivers, which reside in the full power domain (FPD), support data rates of up to 6.0Gb/s. All the protocols cannot be pinned out at the same time. At any given time, four differential pairs can be pinned out using the transceivers. This is user programmable via the high-speed I/O multiplexer (HS-MIO).

- A Quad transceiver PS-GTR (TX/RX pair) able to support following standards simultaneously
 - x1, x2, or x4 lane of PCIe at Gen1 (2.5Gb/s) or Gen2 (5.0Gb/s) rates
 - 1 or 2 lanes of DisplayPort (TX only) at 1.62Gb/s, 2.7Gb/s, or 5.4Gb/s
 - 1 or 2 SATA channels at 1.5Gb/s, 3.0Gb/s, or 6.0Gb/s
 - 1 or 2 USB3.0 channels at 5.0Gb/s
 - 1-4 Ethernet SGMII channels at 1.25Gb/s
- Provides flexible host-programmable multiplexing function for connecting the transceiver resources to the PS masters (DisplayPort, PCIe, Serial-ATA, USB3.0, and GigE).

HS-MIO

The function of the HS-MIO is to multiplex access from the high-speed PS peripheral to the differential pair on the PS-GTR transceiver as defined in the configuration registers. Up to 4 channels of the transceiver are available for use by the high-speed interfaces in the PS.

Table 7: HS-MIO Peripheral Interface Mapping

Peripheral Interface	Lane0	Lane1	Lane2	Lane3
PCIe (x1, x2 or x4)	PCIe0	PCIe1	PCIe2	PCIe3
SATA (1 or 2 channels)	SATA0	SATA1	SATA0	SATA1
DisplayPort (TX only)	DP1	DP0	DP1	DP0
USB0	USB0	USB0	USB0	-
USB1	-	-	-	USB1
SGMII0	SGMII0	-	-	-
SGMII1	-	SGMII1	-	-
SGMII2	-	-	SGMII2	-
SGMII3	-	-	-	SGMII3

PS-PL Interface

The PS-PL interface includes:

- AMBA AXI4 interfaces for primary data communication
 - Six 128-bit/64-bit/32-bit High Performance (HP) Slave AXI interfaces from PL to PS.
 - Four 128-bit/64-bit/32-bit HP AXI interfaces from PL to PS DDR.
 - Two 128-bit/64-bit/32-bit high-performance coherent (HPC) ports from PL to cache coherent interconnect (CCI).
 - Two 128-bit/64-bit/32-bit HP Master AXI interfaces from PS to PL.
 - One 128-bit/64-bit/32-bit interface from PL to RPU in PS (PL_LPD) for low latency access to OCM.
 - One 128-bit/64-bit/32-bit AXI interface from RPU in PS to PL (LPD_PL) for low latency access to PL.
 - One 128-bit AXI interface (ACP port) for I/O coherent access from PL to Cortex-A53 cache memory. This interface provides coherency in hardware for Cortex-A53 cache memory.
 - One 128-bit AXI interface (ACE Port) for Fully coherent access from PL to Cortex-A53. This interface provides coherency in hardware for Cortex-A53 cache memory and the PL.
- Clocks and resets
 - Four PS clock outputs to the PL with start/stop control.
 - Four PS reset outputs to the PL.

High-Performance AXI Ports

The high-performance AXI4 ports provide access from the PL to DDR and high-speed interconnect in the PS. The six dedicated AXI memory ports from the PL to the PS are configurable as either 128-bit, 64-bit, or 32-bit interfaces. These interfaces connect the PL to the memory interconnect via a FIFO interface. Two of the AXI interfaces support I/O coherent access to the APU caches.

Each high-performance AXI port has these characteristics:

- Reduced latency between PL and processing system memory
- 1KB deep FIFO
- Configurable either as 128-bit, 64-bit, or 32-bit AXI interfaces
- Multiple AXI command issuing to DDR

Accelerator Coherency Port (ACP)

The Zynq UltraScale+ MPSoC accelerator coherency port (ACP) is a 64-bit AXI slave interface that provides connectivity between the APU and a potential accelerator function in the PL. The ACP directly connects the PL to the snoop control unit (SCU) of the Arm Cortex-A53 processors, enabling cache-coherent access to CPU data in the L2 cache. The ACP provides a low latency path between the PS and a PL-based accelerator when compared with a legacy cache flushing and loading scheme. The ACP only snoops access in the CPU L2 cache, providing coherency in hardware. It does not support coherency on the PL side. So this interface is ideal for a DMA or an accelerator in the PL that only requires coherency on the CPU cache memories. For example, if a MicroBlaze™ processor in the PL is attached to the ACP interface, the cache of MicroBlaze processor will not be coherent with Cortex-A53 caches.

AXI Coherency Extension (ACE)

The Zynq UltraScale+ MPSoC AXI coherency extension (ACE) is a 64-bit AXI4 slave interface that provides connectivity between the APU and a potential accelerator function in the PL. The ACE directly connects the PL to the snoop control unit (SCU) of the Arm Cortex-A53 processors, enabling cache-coherent access to Cache Coherent Interconnect (CCI). The ACE provides a low-latency path between the PS and a PL-based accelerator when compared with a legacy cache flushing and loading scheme. The ACE snoops accesses to the CCI and the PL side, thus, providing full coherency in hardware. This interface can be used to hook up a cached interface in the PL to the PS as caches on both the Cortex-A53 memories and the PL master are snooped thus providing full coherency. For example, if a MicroBlaze processor in the PL is hooked up using an ACE interface, then Cortex-A53 and MicroBlaze processor caches will be coherent with each other.

Programmable Logic

This section covers the information about blocks in the Programmable Logic (PL).

Device Layout

UltraScale architecture-based devices are arranged in a column-and-grid layout. Columns of resources are combined in different ratios to provide the optimum capability for the device density, target market or application, and device cost. At the core of UltraScale+ MPSoCs is the processing system that displaces some of the full or partial columns of programmable logic resources. [Figure 1](#) shows a device-level view with resources grouped together. For simplicity, certain resources such as the processing system, integrated blocks for PCIe, configuration logic, and System Monitor are not shown.

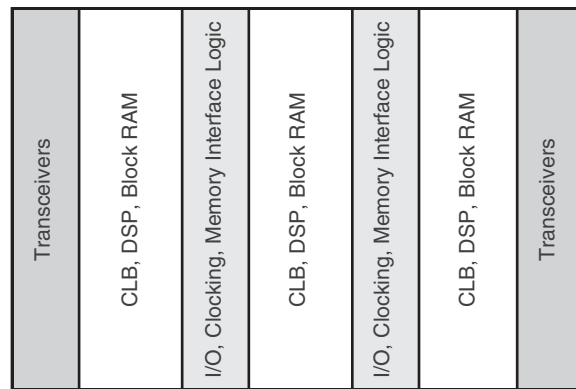

DS891_01_012915

Figure 1: Device with Columnar Resources

Resources within the device are divided into segmented clock regions. The height of a clock region is 60 CLBs. A bank of 52 I/Os, 24 DSP slices, 12 block RAMs, or 4 transceiver channels also matches the height of a clock region. The width of a clock region is essentially the same in all cases, regardless of device size or the mix of resources in the region, enabling repeatable timing results. Each segmented clock region contains vertical and horizontal clock routing that span its full height and width. These horizontal and vertical clock routes can be segmented at the clock region boundary to provide a flexible, high-performance, low-power clock distribution architecture. [Figure 2](#) is a representation of a device divided into regions.

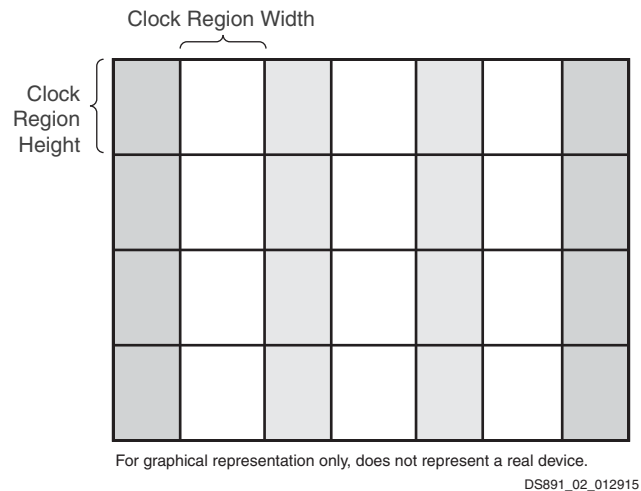

Figure 2: Column-Based Device Divided into Clock Regions

Input/Output

All Zynq UltraScale+ MPSoCs have I/O pins for communicating to external components. In addition, in the MPSoC's PS, there are another 78 I/Os that the I/O peripherals use to communicate to external components, referred to as multiplexed I/O (MIO). If more than 78 pins are required by the I/O peripherals, the I/O pins in the PL can be used to extend the MPSoC interfacing capability, referred to as extended MIO (EMIO).

The number of I/O pins in the PL of Zynq UltraScale+ MPSoCs varies depending on device and package. Each I/O is configurable and can comply with a large number of I/O standards. The I/Os are classed as high-performance (HP), or high-density (HD). The HP I/Os are optimized for highest performance operation, from 1.0V to 1.8V. The HD I/Os are reduced-feature I/Os organized in banks of 24, providing voltage support from 1.2V to 3.3V.

All I/O pins are organized in banks, with 52 HP pins per bank or 24 HD pins per bank. Each bank has one common V_{CC0} output buffer power supply, which also powers certain input buffers. Some single-ended input buffers require an internally generated or an externally applied reference voltage (V_{REF}). V_{REF} pins can be driven directly from the PCB or internally generated using the internal V_{REF} generator circuitry present in each bank.

I/O Electrical Characteristics

Single-ended outputs use a conventional CMOS push/pull output structure driving High towards V_{CC0} or Low towards ground, and can be put into a high-Z state. The system designer can specify the slew rate and the output strength. The input is always active but is usually ignored while the output is active. Each pin can optionally have a weak pull-up or a weak pull-down resistor.

Most signal pin pairs can be configured as differential input pairs or output pairs. Differential input pin pairs can optionally be terminated with a 100 Ω internal resistor. All UltraScale architecture-based devices support differential standards beyond LVDS, including RSDS, BLVDS, differential SSTL, and differential HSTL. Each of the I/Os supports memory I/O standards, such as single-ended and differential HSTL as well as single-ended and differential SSTL.

3-State Digitally Controlled Impedance and Low Power I/O Features

The 3-state Digitally Controlled Impedance (T_DCI) can control the output drive impedance (series termination) or can provide parallel termination of an input signal to V_{CCO} or split (Thevenin) termination to $V_{CCO}/2$. This allows users to eliminate off-chip termination for signals using T_DCI. In addition to board space savings, the termination automatically turns off when in output mode or when 3-stated, saving considerable power compared to off-chip termination. The I/Os also have low power modes for IBUF and IDELAY to provide further power savings, especially when used to implement memory interfaces.

I/O Logic

Input and Output Delay

All inputs and outputs can be configured as either combinatorial or registered. Double data rate (DDR) is supported by all inputs and outputs. Any HP input or output can be individually delayed by up to 1,100ps of delay with a resolution of 2.1–12ps. Such delays are implemented as IDELAY and ODELAY. The number of delay steps can be set by configuration and can also be incremented or decremented while in use. The IDELAY and ODELAY can be cascaded together to double the amount of delay in a single direction.

ISERDES and OSERDES

Many applications combine high-speed, bit-serial I/O with slower parallel operation inside the device. This requires a serializer and deserializer (SerDes) inside the I/O logic. Each HPIO pin possesses an IOSERDES (ISERDES and OSERDES) capable of performing serial-to-parallel or parallel-to-serial conversions with programmable widths of 2, 4, or 8 bits. These I/O logic features enable high-performance interfaces, such as Gigabit Ethernet/1000BaseX/SGMII, to be moved from the transceivers to the SelectIO™ interface.

High-Speed Serial Transceivers

Ultra-fast serial data transmission between devices on the same PCB, over backplanes, and across even longer distances is becoming increasingly important for scaling to 100Gb/s and 400Gb/s line cards. Specialized dedicated on-chip circuitry and differential I/O capable of coping with the signal integrity issues are required at these high data rates.

Two types of transceivers are used in the XA Zynq UltraScale+ MPSoC: GTH and PS-GTR. Both transceivers are arranged in groups of four, known as a transceiver Quad. Each serial transceiver is a combined transmitter and receiver. [Table 8](#) compares the available transceivers.

Table 8: Transceiver Information

	XA Zynq UltraScale+ MPSoC	
Type	PS-GTR	GTH
Qty	4	0-32
Max. Data Rate	6.0Gb/s	12.5Gb/s
Min. Data Rate	1.25Gb/s	0.5Gb/s
Applications	<ul style="list-style-type: none"> • PCIe Gen2 • USB • Ethernet 	<ul style="list-style-type: none"> • Backplane • PCIe Gen3 • HMC

The following information in this section pertains to the GTH only.

The serial transmitter and receiver are independent circuits that use an advanced phase-locked loop (PLL) architecture to multiply the reference frequency input by certain programmable numbers between 4 and 25 to become the bit-serial data clock. Each transceiver has a large number of user-definable features and parameters. All of these can be defined during device configuration, and many can also be modified during operation.

Transmitter

The transmitter is fundamentally a parallel-to-serial converter with a conversion ratio of 16, 20, 32, 40, 64, or 80 for the GTH. This allows the designer to trade off datapath width against timing margin in high-performance designs. These transmitter outputs drive the PC board with a single-channel differential output signal. TXOUTCLK is the appropriately divided serial data clock and can be used directly to register the parallel data coming from the internal logic. The incoming parallel data is fed through an optional FIFO and has additional hardware support for the 8B/10B, 64B/66B, or 64B/67B encoding schemes to provide a sufficient number of transitions. The bit-serial output signal drives two package pins with differential signals. This output signal pair has programmable signal swing as well as programmable pre- and post-emphasis to compensate for PC board losses and other interconnect characteristics. For shorter channels, the swing can be reduced to reduce power consumption.

Receiver

The receiver is fundamentally a serial-to-parallel converter, changing the incoming bit-serial differential signal into a parallel stream of words, each 16, 20, 32, 40, 64, or 80 bits in the GTH. This allows the designer to trade off internal datapath width against logic timing margin. The receiver takes the incoming differential data stream, feeds it through programmable DC automatic gain control, linear and decision feedback equalizers (to compensate for PC board, cable, optical and other interconnect characteristics), and uses the reference clock input to initiate clock recognition. There is no need for a separate clock line. The data pattern uses non-return-to-zero (NRZ) encoding and optionally ensures sufficient data transitions by using the selected encoding scheme. Parallel data is then transferred into the device logic using the RXUSRCLK clock. For short channels, the transceivers offer a special low-power mode (LPM) to reduce power consumption by approximately 30%. The receiver DC automatic gain control and linear and decision feedback equalizers can optionally "auto-adapt" to automatically learn and compensate for different interconnect characteristics. This enables even more margin for tough 10G+ and 25G+ backplanes.

Out-of-Band Signaling

The transceivers provide out-of-band (OOB) signaling, often used to send low-speed signals from the transmitter to the receiver while high-speed serial data transmission is not active. This is typically done when the link is in a powered-down state or has not yet been initialized. This benefits PCIe and SATA/SAS and QPI applications.

Integrated Interface Blocks for PCI Express Designs

The MPSoC PL includes integrated blocks for PCIe technology that can be configured as an Endpoint or Root Port, compliant to the PCI Express Base Specification Revision 3.1 for Gen3 and lower data rates. The Root Port can be used to build the basis for a compatible Root Complex, to allow custom chip-to-chip communication via the PCI Express protocol, and to attach ASSP Endpoint devices, such as Ethernet Controllers or Fibre Channel HBAs, to the MPSoC.

This block is highly configurable to system design requirements and can operate 1, 2, 4, 8, or 16 lanes at up to 2.5Gb/s, 5.0Gb/s, or 8.0Gb/s data rates. For high-performance applications, advanced buffering techniques of the block offer a flexible maximum payload size of up to 1,024 bytes. The integrated block interfaces to the integrated high-speed transceivers for serial connectivity and to block RAMs for data buffering. Combined, these elements implement the Physical Layer, Data Link Layer, and Transaction Layer of the PCI Express protocol.

We provide a light-weight, configurable, easy-to-use LogiCORE™ IP wrapper that ties the various building blocks (the integrated block for PCIe, the transceivers, block RAM, and clocking resources) into an Endpoint or Root Port solution. The system designer has control over many configurable parameters: link width and speed, maximum payload size, MPSoC logic interface speeds, reference clock frequency, and base address register decoding and filtering.

Clock Management

The clock generation and distribution components in UltraScale architecture-based devices are located adjacent to the columns that contain the memory interfacing and input and output circuitry. This tight coupling of clocking and I/O provides low-latency clocking to the I/O for memory interfaces and other I/O protocols. Within every clock management tile (CMT) resides one mixed-mode clock manager (MMCM), two PLLs, clock distribution buffers and routing, and dedicated circuitry for implementing external memory interfaces.

Mixed-Mode Clock Manager

The mixed-mode clock manager (MMCM) can serve as a frequency synthesizer for a wide range of frequencies and as a jitter filter for incoming clocks. At the center of the MMCM is a voltage-controlled oscillator (VCO), which speeds up and slows down depending on the input voltage it receives from the phase frequency detector (PFD).

Three sets of programmable frequency dividers (D, M, and O) are programmable by configuration and during normal operation via the Dynamic Reconfiguration Port (DRP). The pre-divider D reduces the input frequency and feeds one input of the phase/frequency comparator. The feedback divider M acts as a multiplier because it divides the VCO output frequency before feeding the other input of the phase comparator. D and M must be chosen appropriately to keep the VCO within its specified frequency range. The VCO has eight equally-spaced output phases (0°, 45°, 90°, 135°, 180°, 225°, 270°, and 315°). Each phase can be selected to drive one of the output dividers, and each divider is programmable by configuration to divide by any integer from 1 to 128.

The MMCM has three input-jitter filter options: low bandwidth, high bandwidth, or optimized mode. Low-Bandwidth mode has the best jitter attenuation. High-Bandwidth mode has the best phase offset. Optimized mode allows the tools to find the best setting.

The MMCM can have a fractional counter in either the feedback path (acting as a multiplier) or in one output path. Fractional counters allow non-integer increments of 1/8 and can thus increase frequency synthesis capabilities by a factor of 8. The MMCM can also provide fixed or dynamic phase shift in small increments that depend on the VCO frequency. At 1,600MHz, the phase-shift timing increment is 11.2ps.

PLL

With fewer features than the MMCM, the two PLLs in a clock management tile are primarily present to provide the necessary clocks to the dedicated memory interface circuitry. The circuit at the center of the PLLs is similar to the MMCM, with PFD feeding a VCO and programmable M, D, and O counters. There are two divided outputs to the device fabric per PLL as well as one clock plus one enable signal to the memory interface circuitry.

Zynq UltraScale+ MPSoCs are equipped with five additional PLLs in the PS for independently configuring the four primary clock domains with the PS: the APU, the RPU, the DDR controller, and the I/O peripherals.

Clock Distribution

Clocks are distributed throughout Zynq UltraScale+ MPSoCs via buffers that drive a number of vertical and horizontal tracks. There are 24 horizontal clock routes per clock region and 24 vertical clock routes per clock region with 24 additional vertical clock routes adjacent to the MMCM and PLL. Within a clock region, clock signals are routed to the device logic (CLBs, etc.) via 16 gateable leaf clocks.

Several types of clock buffers are available. The BUFGCE and BUFCE_LEAF buffers provide clock gating at the global and leaf levels, respectively. BUFGCTRL provides glitchless clock muxing and gating capability. BUFGCE_DIV has clock gating capability and can divide a clock by 1 to 8. BUFG_GT performs clock division from 1 to 8 for the transceiver clocks. In MPSoCs, clocks can be transferred from the PS to the PL using dedicated buffers.

Memory Interfaces

Memory interface data rates continue to increase, driving the need for dedicated circuitry that enables high performance, reliable interfacing to current and next-generation memory technologies. Every Zynq UltraScale+ MPSoC includes dedicated physical interfaces (PHY) blocks located between the CMT and I/O columns that support implementation of high-performance PHY blocks to external memories such as DDR4, DDR3, QDRII+, and RLDRAM3. The PHY blocks in each I/O bank generate the address/control and data bus signaling protocols as well as the precision clock/data alignment required to reliably communicate with a variety of high-performance memory standards. Multiple I/O banks can be used to create wider memory interfaces.

As well as external parallel memory interfaces, Zynq UltraScale+ MPSoC can communicate to external serial memories, such as Hybrid Memory Cube (HMC), via the high-speed serial transceivers. All transceivers in the UltraScale architecture support the HMC protocol, up to 12.5Gb/s line rates. UltraScale architecture-based devices support the highest bandwidth HMC configuration of 64 lanes with a single device.

Configurable Logic Block

Every configurable logic block (CLB) in the UltraScale architecture contains 8 LUTs and 16 flip-flops. The LUTs can be configured as either one 6-input LUT with one output, or as two 5-input LUTs with separate outputs but common inputs. Each LUT can optionally be registered in a flip-flop. In addition to the LUTs and flip-flops, the CLB contains arithmetic carry logic and multiplexers to create wider logic functions.

Each CLB contains one slice. There are two types of slices: SLICEL and SLICEM. LUTs in the SLICEM can be configured as 64-bit RAM, as 32-bit shift registers (SRL32), or as two SRL16s. CLBs in the UltraScale architecture have increased routing and connectivity compared to CLBs in previous-generation devices. They also have additional control signals to enable superior register packing, resulting in overall higher device utilization.

Interconnect

Various length vertical and horizontal routing resources in the UltraScale architecture that span 1, 2, 4, 5, 12, or 16 CLBs ensure that all signals can be transported from source to destination with ease, providing support for the next generation of wide data buses to be routed across even the highest capacity devices while simultaneously improving quality of results and software run time.

Block RAM

Every UltraScale architecture-based device contains a number of 36Kb block RAMs, each with two completely independent ports that share only the stored data. Each block RAM can be configured as one 36Kb RAM or two independent 18Kb RAMs. Each memory access, read or write, is controlled by the clock. Connections in every block RAM column enable signals to be cascaded between vertically adjacent block RAMs, providing an easy method to create large, fast memory arrays, and FIFOs with greatly reduced power consumption.

All inputs, data, address, clock enables, and write enables are registered. The input address is always clocked (unless address latching is turned off), retaining data until the next operation. An optional output data pipeline register allows higher clock rates at the cost of an extra cycle of latency. During a write operation, the data output can reflect either the previously stored data or the newly written data, or it can remain unchanged. Block RAM sites that remain unused in the user design are automatically powered down to reduce total power consumption. There is an additional pin on every block RAM to control the dynamic power gating feature.

Programmable Data Width

Each port can be configured as $32K \times 1$; $16K \times 2$; $8K \times 4$; $4K \times 9$ (or 8); $2K \times 18$ (or 16); $1K \times 36$ (or 32); or 512×72 (or 64). Whether configured as block RAM or FIFO, the two ports can have different aspect ratios without any constraints. Each block RAM can be divided into two completely independent 18Kb block RAMs that can each be configured to any aspect ratio from $16K \times 1$ to 512×36 . Everything described previously for the full 36Kb block RAM also applies to each of the smaller 18Kb block RAMs. Only in simple dual-port (SDP) mode can data widths of greater than 18 bits (18Kb RAM) or 36 bits (36Kb RAM) be accessed. In this mode, one port is dedicated to read operation, the other to write operation. In SDP mode, one side (read or write) can be variable, while the other is fixed to 32/36 or 64/72. Both sides of the dual-port 36Kb RAM can be of variable width.

Error Detection and Correction

Each 64-bit-wide block RAM can generate, store, and utilize eight additional Hamming code bits and perform single-bit error correction and double-bit error detection (ECC) during the read process. The ECC logic can also be used when writing to or reading from external 64- to 72-bit-wide memories.

FIFO Controller

Each block RAM can be configured as a 36Kb FIFO or an 18Kb FIFO. The built-in FIFO controller for single-clock (synchronous) or dual-clock (asynchronous or multirate) operation increments the internal addresses and provides four handshaking flags: full, empty, programmable full, and programmable empty. The programmable flags allow the user to specify the FIFO counter values that make these flags go active. The FIFO width and depth are programmable with support for different read port and write port widths on a single FIFO. A dedicated cascade path allows for easy creation of deeper FIFOs.

UltraRAM

UltraRAM is a high-density, dual-port, synchronous memory block used in some UltraScale+ families. Both of the ports share the same clock and can address all of the 4K x 72 bits. Each port can independently read from or write to the memory array. UltraRAM supports two types of write enable schemes. The first mode is consistent with the block RAM byte write enable mode. The second mode allows gating the data and parity byte writes separately. Multiple UltraRAM blocks can be cascaded together to create larger memory arrays. UltraRAM blocks can be connected together to create larger memory arrays. Dedicated routing in the UltraRAM column enables the entire column height to be connected together. This makes UltraRAM an ideal solution for replacing external memories such as SRAM. Cascadable anywhere from 288Kb to 36Mb, UltraRAM provides the flexibility to fulfill many different memory requirements.

Error Detection and Correction

Each 64-bit-wide UltraRAM can generate, store and utilize eight additional Hamming code bits and perform single-bit error correction and double-bit error detection (ECC) during the read process.

Digital Signal Processing

DSP applications use many binary multipliers and accumulators, best implemented in dedicated DSP slices. All UltraScale architecture-based devices have many dedicated, low-power DSP slices, combining high speed with small size while retaining system design flexibility.

Each DSP slice fundamentally consists of a dedicated 27×18 bit two's complement multiplier and a 48-bit accumulator. The multiplier can be dynamically bypassed, and two 48-bit inputs can feed a single-instruction-multiple-data (SIMD) arithmetic unit (dual 24-bit add/subtract/accumulate or quad 12-bit add/subtract/accumulate), or a logic unit that can generate any one of ten different logic functions of the two operands.

The DSP includes an additional pre-adder, typically used in symmetrical filters. This pre-adder improves performance in densely packed designs and reduces the DSP slice count by up to 50%. The 96-bit-wide XOR function, programmable to 12, 24, 48, or 96-bit widths, enables performance improvements when implementing forward error correction and cyclic redundancy checking algorithms.

The DSP also includes a 48-bit-wide pattern detector that can be used for convergent or symmetric rounding. The pattern detector is also capable of implementing 96-bit-wide logic functions when used in conjunction with the logic unit.

The DSP slice provides extensive pipelining and extension capabilities that enhance the speed and efficiency of many applications beyond digital signal processing, such as wide dynamic bus shifters, memory address generators, wide bus multiplexers, and memory-mapped I/O register files. The accumulator can also be used as a synchronous up/down counter.

System Monitor

The System Monitor blocks in the UltraScale architecture are used to enhance the overall safety, security, and reliability of the system by monitoring the physical environment via on-chip power supply and temperature sensors.

All UltraScale architecture-based devices contain at least one System Monitor. The System Monitor in UltraScale+ devices is similar to the Kintex UltraScale and Virtex UltraScale devices but with the addition of a PMBus interface.

Zynq UltraScale+ MPSoCs contain one System Monitor in the PL and an additional block in the PS. The System Monitor in the PL has the same features as the block in UltraScale+ FPGAs. See [Table 9](#).

Table 9: Key System Monitor Features

	Zynq UltraScale+ MPSoC PL	Zynq UltraScale+ MPSoC PS
ADC	10-bit 200kSPS	10-bit 1MSPS
Interfaces	JTAG, I2C, DRP, PMBus	APB

In FPGAs and the MPSoC PL, sensor outputs and up to 17 user-allocated external analog inputs are digitized using a 10-bit 200 kilo-sample-per-second (kSPS) ADC, and the measurements are stored in registers that can be accessed via internal FPGA (DRP), JTAG, PMBus, or I2C interfaces. The I2C interface and PMBus allow the on-chip monitoring to be easily accessed by the System Manager/Host before and after device configuration.

The System Monitor in the MPSoC PS uses a 10-bit, 1 mega-sample-per-second (MSPS) ADC to digitize the sensor inputs. The measurements are stored in registers and are accessed via the Advanced Peripheral Bus (APB) interface by the processors and the PMU in the PS.

Packaging

The UltraScale architecture-based devices are available in a variety of organic flip-chip and lidless flip-chip packages supporting different quantities of I/Os and transceivers. Maximum supported performance can depend on the style of package and its material. Always refer to the specific device data sheet for performance specifications by package type.

In flip-chip packages, the silicon device is attached to the package substrate using a high-performance flip-chip process. Decoupling capacitors are mounted on the package substrate to optimize signal integrity under simultaneous switching of outputs (SSO) conditions.

System-Level Features

Several functions span both the PS and PL and include:

- Reset Management
- Clock Management
- Power Domains
- PS Boot and Device Configuration
- Hardware and Software Debug Support

Reset Management

The reset management function provides the ability to reset the entire device or individual units within it. The PS supports these reset functions and signals:

- External and internal power-on reset signal
- Warm reset
- Watchdog timer reset
- User resets to PL
- Software, watchdog timer, or JTAG provided resets
- Security violation reset (locked down reset)

Clock Management

The PS in Zynq UltraScale+ MPSoCs is equipped with five phase-locked loops (PLLs), providing flexibility in configuring the clock domains within the PS. There are four primary clock domains of interest within the PS. These include the APU, the RPU, the DDR controller, and the I/O peripherals (IOP). The frequencies of all of these domains can be configured independently under software control.

Power Domains

The Zynq UltraScale+ MPSoC contains four separate power domains. When they are connected to separate power supplies, they can be completely powered down independently of each other without consuming any dynamic or static power. The processing system includes:

- Full Power Domain (FPD)
- Low Power Domain (LPD)
- Battery Powered Domain (BPD)

In addition to these three Processing System power domains, the PL can also be completely powered down if connected to separate power supplies.

The Full Power Domain (FPD) consists of the following major blocks:

- Application Processing Unit (APU)
- DMA (FP-DMA)
- Graphics Processing Unit (GPU)
- Dynamic Memory Controller (DDRC)
- High-Speed I/O Peripherals

The Low Power Domain (LPD) consists of the following major blocks:

- Real-Time Processing Unit (RPU)
- DMA (LP-DMA)
- Platform Management Unit (PMU)
- Configuration Security Unit (CSU)
- Low-Speed I/O Peripherals
- Static Memory Interfaces

The Battery Power Domain (BPD) is the lowest power domain of the Zynq UltraScale+ MPSoC processing system. In this mode, all the PS is powered off except the Real-Time Clock (RTC) and battery-backed RAM (BBRAM).

Power Examples

Power for the Zynq UltraScale+ MPSoCs varies depending on the utilization of the PL resources, and the frequency of the PS and PL. To estimate power, use the Xilinx Power Estimator (XPE) at:

<https://www.xilinx.com/products/technology/power/xpe.html>

PS Boot and Device Configuration

Zynq UltraScale+ MPSoCs use a multi-stage boot process that supports both a non-secure and a secure boot. The PS is the master of the boot and configuration process. For a secure boot, the AES-GCM, SHA-3/384 decrypts and authenticates the images while the 4,096-bit RSA block authenticates the image.

Upon reset, the device mode pins are read to determine the primary boot device to be used: NAND, Quad-SPI, SD, eMMC, or JTAG. JTAG can only be used as a non-secure boot source and is intended for debugging purposes. The CSU executes code out of on-chip ROM and copies the first stage boot loader (FSBL) from the boot device to the OCM.

After copying the FSBL to OCM, one of the processors, either the Cortex-A53 or Cortex-R5, executes the FSBL. We supply example FSBLs or users can create their own. The FSBL initiates the boot of the PS and can load and configure the PL, or configuration of the PL can be deferred to a later stage. The FSBL typically loads either a user application or an optional second stage boot loader (SSBL), such as U-Boot. Users obtain example SSBL from us or a third party, or they can create their own SSBL. The SSBL continues the boot process by loading code from any of the primary boot devices or from other sources such as USB, Ethernet, etc. If the FSBL did not configure the PL, the SSBL can do so, or again, the configuration can be deferred to a later stage.

The static memory interface controller (NAND, eMMC, or Quad-SPI) is configured using default settings. To improve device configuration speed, these settings can be modified by information provided in the boot image header. The ROM boot image is not user readable or callable after boot.

Hardware and Software Debug Support

The debug system used in Zynq UltraScale+ MPSoCs is based on the Arm CoreSight architecture. It uses Arm CoreSight components including an embedded trace controller (ETC), an embedded trace Macrocell (ETM) for each Cortex-A53 and Cortex-R5 processor, and a system trace Macrocell (STM). This enables advanced debug features like event trace, debug breakpoints and triggers, cross-trigger, and debug bus dump to memory. The programmable logic can be debugged with the Vivado Logic Analyzer.

Debug Ports

Three JTAG ports are available and can be chained together or used separately. When chained together, a single port is used for chip-level JTAG functions, Arm processor code downloads and run-time control operations, PL configuration, and PL debug with the Vivado Logic Analyzer. This enables tools such as the Software Development Kit (SDK) and Vivado Logic Analyzer to share a single download cable.

When the JTAG chain is split, one port is used to directly access the Arm DAP interface. This CoreSight interface enables the use of Arm-compliant debug and software development tools such as Development Studio 5 (DS-5™). The other JTAG port can then be used by the FPGA tools for access to the PL, including configuration bitstream downloads and PL debug with the Vivado Logic Analyzer. In this mode, users can download to and debug the PL in the same manner as a stand-alone FPGA.

Ordering Information

Table 10 shows the speed and temperature grades available in the different device families.

Table 10: Speed Grades, Temperature Grades, and Operating Voltages

Device Family	Devices	Speed Grade and Temperature Grade	
		Industrial (I)	Automotive (Q)
		-40°C to +100°C	-40°C to +125°C
XA Zynq UltraScale+(1)(2)	EG and EV Devices	-1I (0.85V)	-1Q (0.85V)
		-1L (0.72V)	

Notes:

1. In Zynq UltraScale+ MPSoCs, when operating the PL at low voltage (0.72V), the PS operates at nominal voltage (0.85V)
2. XAZU11EG and XAZU7EV -1L speed grades are not supported.

The ordering information shown in Figure 3 applies to all packages in the XA Zynq UltraScale+ MPSoC.

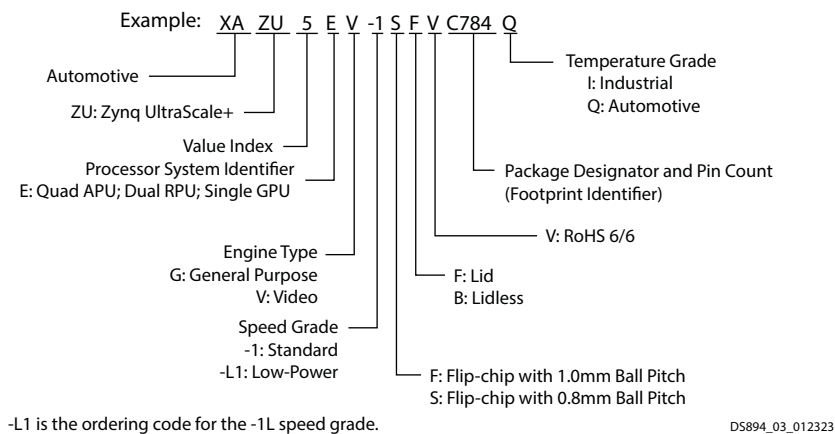

Figure 3: XA Zynq UltraScale+ MPSoC Ordering Information

Revision History

The following table shows the revision history for this document:

Date	Version	Description of Revisions
05/15/2023	1.5	Added the XAZU3TEG throughout document. Updated PCI Express , Table 1 , and Power Examples .
08/09/2022	1.4	Added the XAZU1EG device throughout document. Update table notes in Table 10 . Updated I/O Logic .
11/11/2019	1.3	Added XAZU7EV and XAZU11EG devices throughout document. Updated On-Chip Memory , Table 1 , Table 2 , Table 3 , Table 4 , Table 8 , and Figure 3 .
07/13/2017	1.2	Updated Table 3 , Application Processing Unit (APU) , and Real-Time Processing Unit (RPU) .
03/23/2017	1.1	Updated Table 3 , Table 10 , and Figure 3 .
11/09/2016	1.0	Initial Xilinx release.

Please Read: Important Legal Notices

The information presented in this document is for informational purposes only and may contain technical inaccuracies, omissions, and typographical errors. The information contained herein is subject to change and may be rendered inaccurate for many reasons, including but not limited to product and roadmap changes, component and motherboard version changes, new model and/or product releases, product differences between differing manufacturers, software changes, BIOS flashes, firmware upgrades, or the like. Any computer system has risks of security vulnerabilities that cannot be completely prevented or mitigated. AMD assumes no obligation to update or otherwise correct or revise this information. However, AMD reserves the right to revise this information and to make changes from time to time to the content hereof without obligation of AMD to notify any person of such revisions or changes. THIS INFORMATION IS PROVIDED "AS IS." AMD MAKES NO REPRESENTATIONS OR WARRANTIES WITH RESPECT TO THE CONTENTS HEREOF AND ASSUMES NO RESPONSIBILITY FOR ANY INACCURACIES, ERRORS, OR OMISSIONS THAT MAY APPEAR IN THIS INFORMATION. AMD SPECIFICALLY DISCLAIMS ANY IMPLIED WARRANTIES OF NON-INFRINGEMENT, MERCHANTABILITY, OR FITNESS FOR ANY PARTICULAR PURPOSE. IN NO EVENT WILL AMD BE LIABLE TO ANY PERSON FOR ANY RELIANCE, DIRECT, INDIRECT, SPECIAL, OR OTHER CONSEQUENTIAL DAMAGES ARISING FROM THE USE OF ANY INFORMATION CONTAINED HEREIN, EVEN IF AMD IS EXPRESSLY ADVISED OF THE POSSIBILITY OF SUCH DAMAGES.

AUTOMOTIVE APPLICATIONS DISCLAIMER

AUTOMOTIVE PRODUCTS (IDENTIFIED AS "XA" IN THE PART NUMBER) ARE NOT WARRANTED FOR USE IN THE DEPLOYMENT OF AIRBAGS OR FOR USE IN APPLICATIONS THAT AFFECT CONTROL OF A VEHICLE ("SAFETY APPLICATION") UNLESS THERE IS A SAFETY CONCEPT OR REDUNDANCY FEATURE CONSISTENT WITH THE ISO 26262 AUTOMOTIVE SAFETY STANDARD ("SAFETY DESIGN"). CUSTOMER SHALL, PRIOR TO USING OR DISTRIBUTING ANY SYSTEMS THAT INCORPORATE PRODUCTS, THOROUGHLY TEST SUCH SYSTEMS FOR SAFETY PURPOSES. USE OF PRODUCTS IN A SAFETY APPLICATION WITHOUT A SAFETY DESIGN IS FULLY AT THE RISK OF CUSTOMER, SUBJECT ONLY TO APPLICABLE LAWS AND REGULATIONS GOVERNING LIMITATIONS ON PRODUCT LIABILITY.

© Copyright 2016–2023 Advanced Micro Devices, Inc. AMD, the AMD Arrow logo, Zynq, UltraScale+, Vivado, and combinations thereof are trademarks of Advanced Micro Devices, Inc. Other product names used in this publication are for identification purposes only and may be trademarks of their respective companies. AMBA, AMBA Designer, Arm, Arm1176JZ-S, CoreSight, Cortex, PrimeCell, Mali, and MPCore are trademarks of Arm in the EU and other countries. PCI, PCIe, and PCI Express are trademarks of PCI-SIG and are used under license. All other trademarks are the property of their respective owners.

Looking for pricing, stock, or lifecycle information?

Click below to explore more details on WIN SOURCE:

 [View XAZU3EG-L1SFVC784I on WIN SOURCE](#)

 [Amd Information](#)

Optimize Your Supply Chain with WIN SOURCE Solutions

-  Global Sourcing Solution
-  Obsolete Management
-  Cost Control Management
-  Shortage Management
-  Alternative Solution
-  Excess Inventory Management