



**THE DATASHEET OF
BAT 60A E6327**



BAT15-04R

Reverse series silicon RF Schottky diode pair



Order now



Technical documents



Simulation



Support

Product description

These Infineon RF Schottky diodes are silicon low barrier N-type devices with an integrated guard ring on-chip for over-voltage protection. Their low barrier height, low forward voltage and low junction capacitance make BAT15-04R a suitable choice for mixer and detector functions in applications which frequencies are as high as 12 GHz.



Feature list

- Low inductance $L_S = 1.5$ nH (typical)
- Low capacitance $C = 0.27$ pF (typical) at 1 MHz
- Industry standard SOT23-3 package (2.9 mm x 2.4 mm x 1 mm)
- Pb-free, RoHS compliant

Product validation

Qualified for industrial applications according to the relevant tests of JEDEC47/20/22.

Potential applications

For mixers and detectors in:

- Satellite systems
- Low noise blocks for Ku bands
- Security systems

Device information

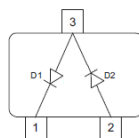

Table 1 Part information

Product name / Ordering code	Package	Pin configuration	Marking	Pieces / Reel
BAT15-04R / BAT1504RE6152HTSA1	SOT23-3	Reverse series pair	4R	3 k

Attention: *ESD (Electrostatic discharge) sensitive device, observe handling precautions!*

Table of contents

Product description 1

Feature list 1

Product validation 1

Potential applications 1

Device information 1

Table of contents 2

1 Absolute maximum ratings 2

2 Electrical performance in test fixture 3

2.1 Electrical characteristics 3

2.2 Characteristic curves 4

3 Thermal characteristics 6

4 Package information SOT23-3 8

Revision history 8

Disclaimer 9

1 Absolute maximum ratings

Table 2 Absolute maximum ratings at $T_A = 25\text{ °C}$, unless otherwise specified

Parameter	Symbol	Values		Unit	Note or test condition
		Min.	Max.		
Diode reverse voltage	V_R	-	4	V	
Forward current	I_F	-	110	mA	
Total power dissipation	P_{TOT}	-	100	mW	$T_S \leq 77\text{ °C}$ ¹⁾
Junction temperature	T_J	-	150	°C	
Operating temperature	T_{OP}	-55	150		
Storage temperature	T_{STG}	-55	150		

Attention: Stresses above the maximum values listed here may cause permanent damage to the device. Exposure to absolute maximum rating conditions for extended periods may affect device reliability. Exceeding only one of these values may cause irreversible damage to the component.

¹ T_S is the soldering point temperature.

2 Electrical performance in test fixture

2.1 Electrical characteristics

Table 3 Electrical characteristics at $T_A = 25\text{ °C}$, unless otherwise specified

Parameter	Symbol	Values			Unit	Note or test condition
		Min.	Typ.	Max.		
Breakdown voltage	V_{BR}	4	–	–	V	$I_R = 10\ \mu\text{A}$
Forward voltage	V_F	0.2	0.25	0.3	V	$I_F = 1\ \text{mA}$
		–	0.35	0.41		$I_F = 10\ \text{mA}$
Forward voltage matching	ΔV_F	–	–	10	mV	$I_F = 1\ \text{mA}$ ²⁾
Differential forward resistance	R_F	–	8	–	Ω	$I_F = 10\ \text{mA} / 50\ \text{mA}$ ³⁾
		–	12	18	Ω	$I_F = 5\ \text{mA}$
Capacitance	C	–	0.26	0.3	pF	$V_R = 0\ \text{V}, f = 1\ \text{MHz}$
Inductance	L_S	–	1.5	–	nH	

²⁾ ΔV_F is the difference between lowest and highest V_F in a multiple diode component.

³⁾
$$R_F = \frac{V_F(50\ \text{mA}) - V_F(10\ \text{mA})}{50\ \text{mA} - 10\ \text{mA}}$$

2.2 Characteristic curves

At $T_A = 25\text{ }^\circ\text{C}$, unless otherwise specified

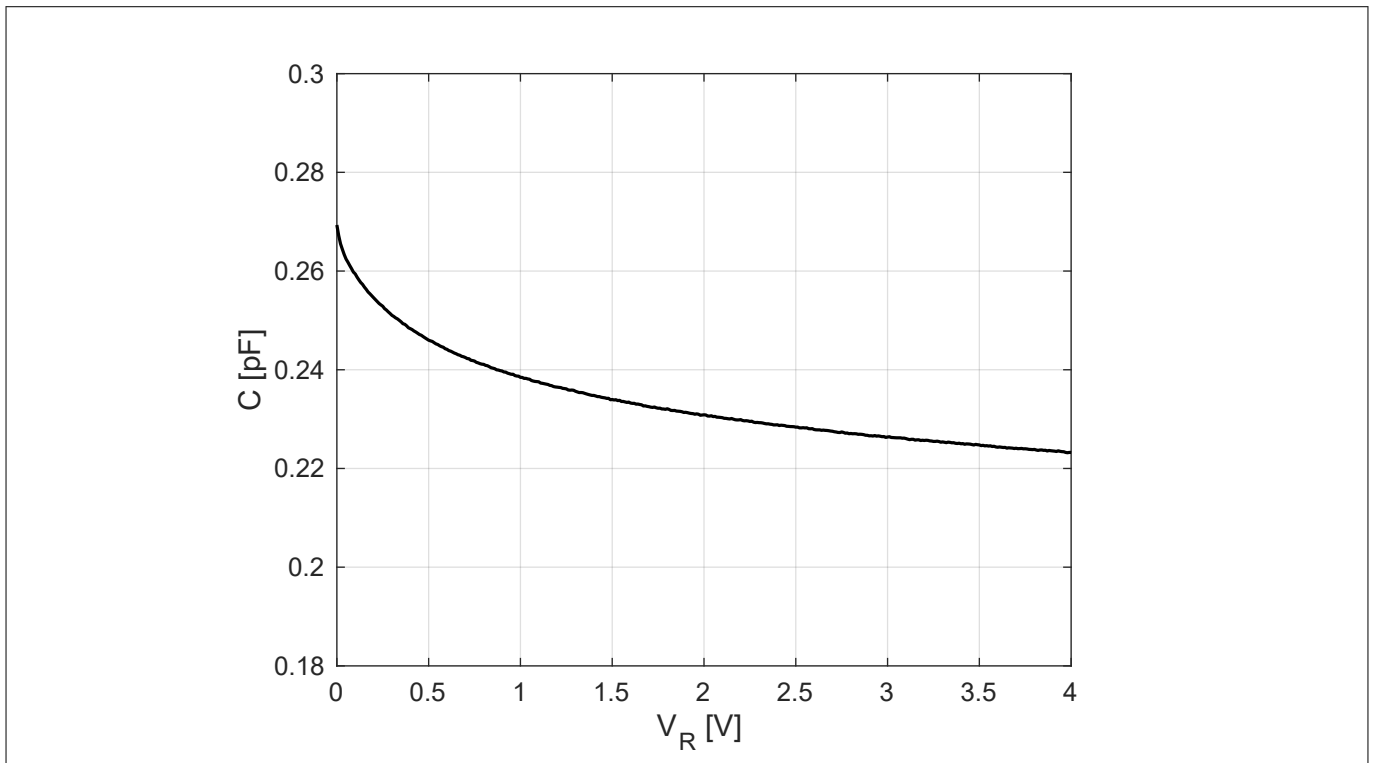

Figure 1 Diode capacitance C vs. reverse voltage V_R at frequency $f = 1\text{ MHz}$

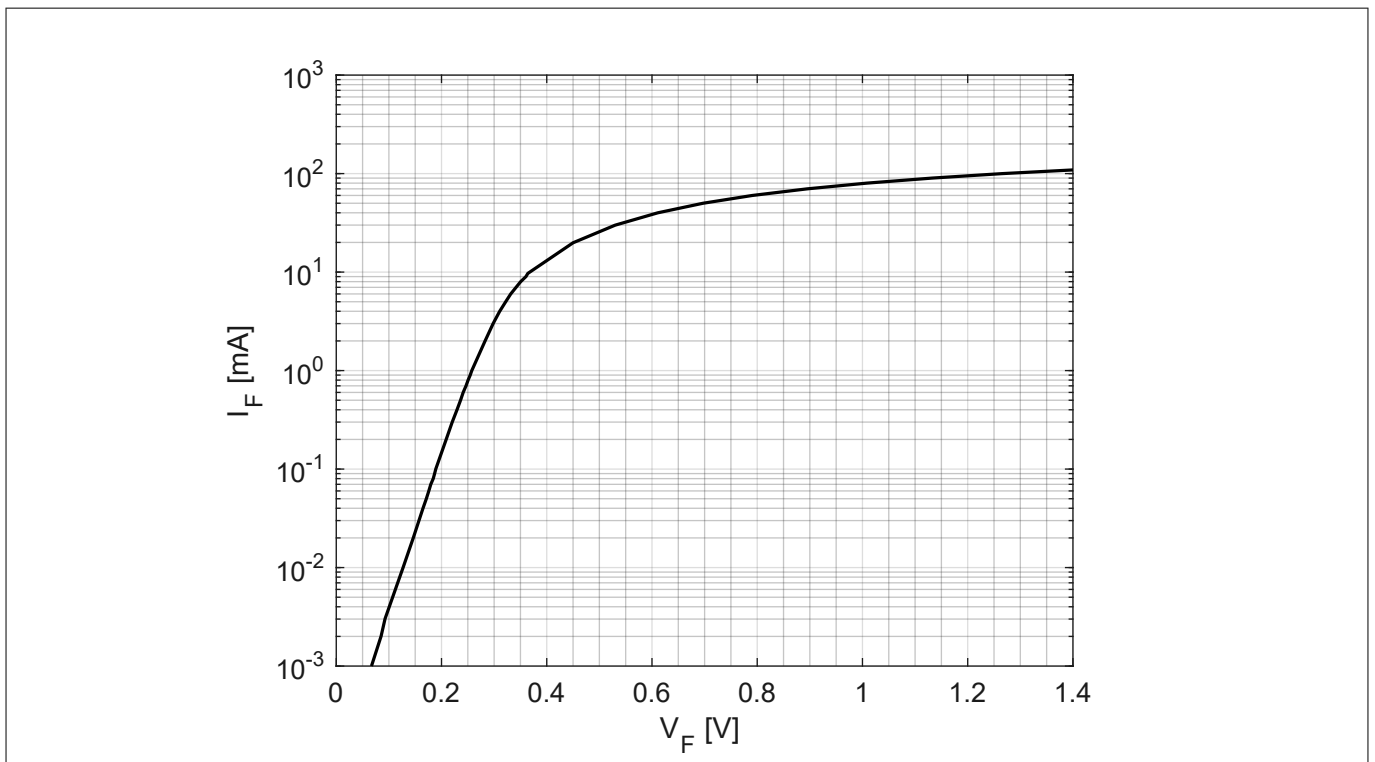

Figure 2 Forward current I_F vs. forward voltage V_F

Electrical performance in test fixture

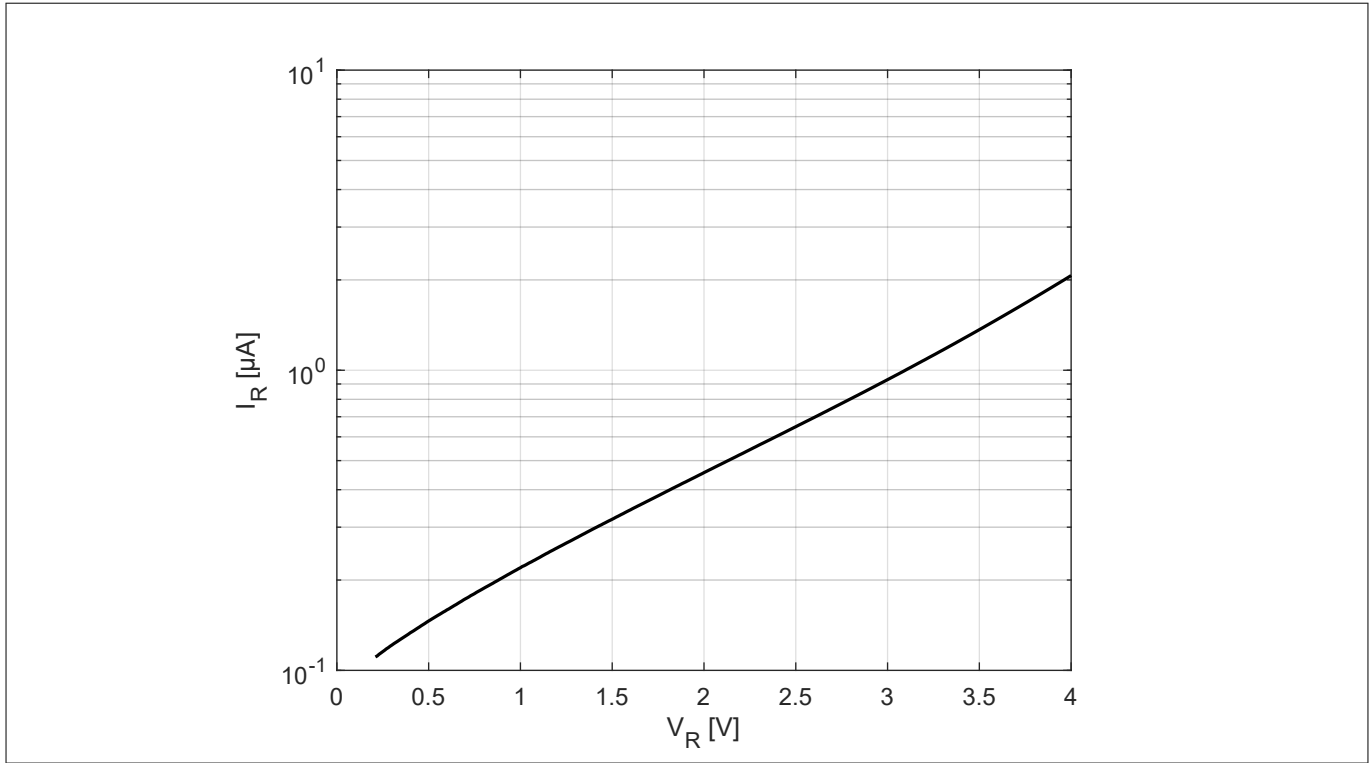

Figure 3 Reverse current I_R vs. reverse voltage V_R

Note: The curves shown in this chapter have been generated using typical devices but shall not be understood as a guarantee that all devices have identical characteristic curves.

Thermal characteristics

3 Thermal characteristics

Table 4 Thermal resistance

Parameter	Symbol	Values			Unit	Note or test condition
		Min.	Typ.	Max.		
Thermal resistance (junction - soldering point)	R_{thJS}	-	725	-	K/W	$T_S = 77\text{ °C}$ ⁴⁾

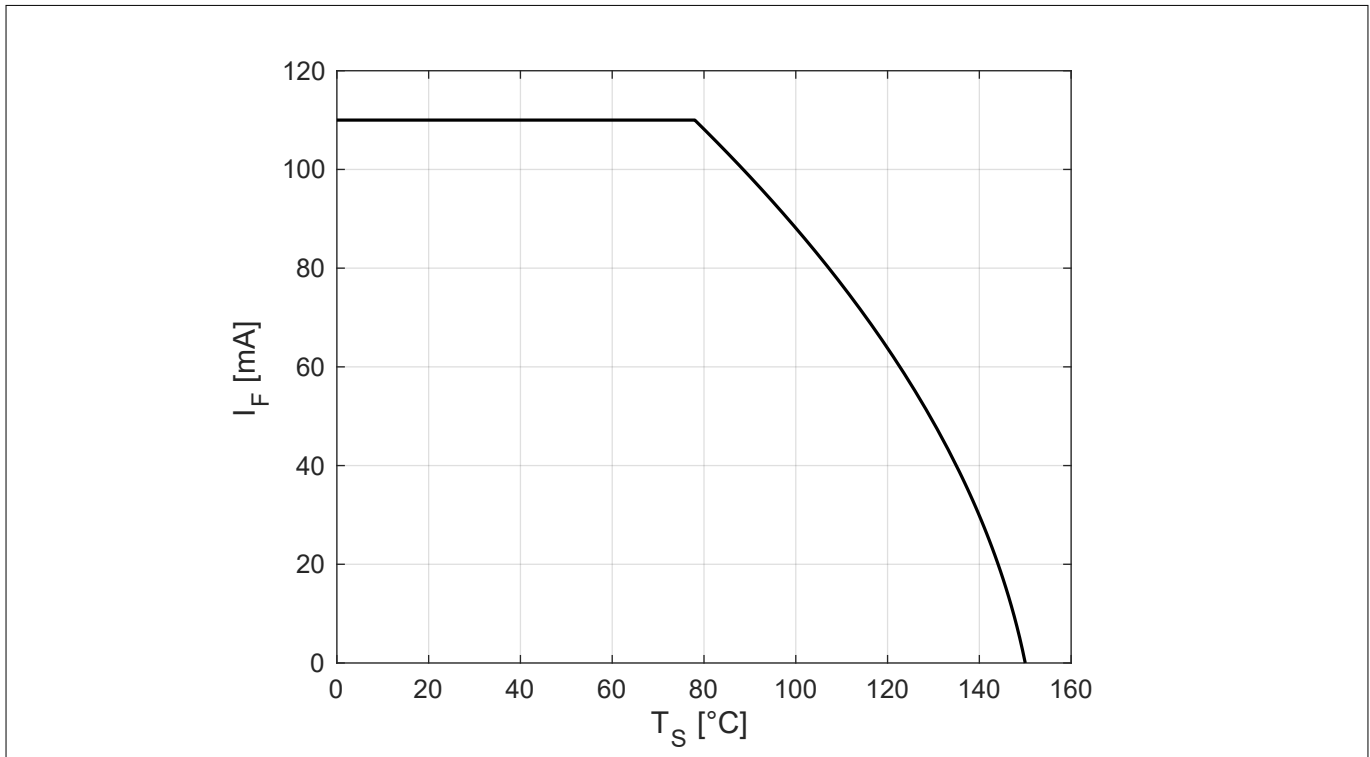

Figure 4 Permissible forward current I_F in DC operation

⁴ For R_{thJS} in other conditions refer to the curves in this chapter.

Thermal characteristics

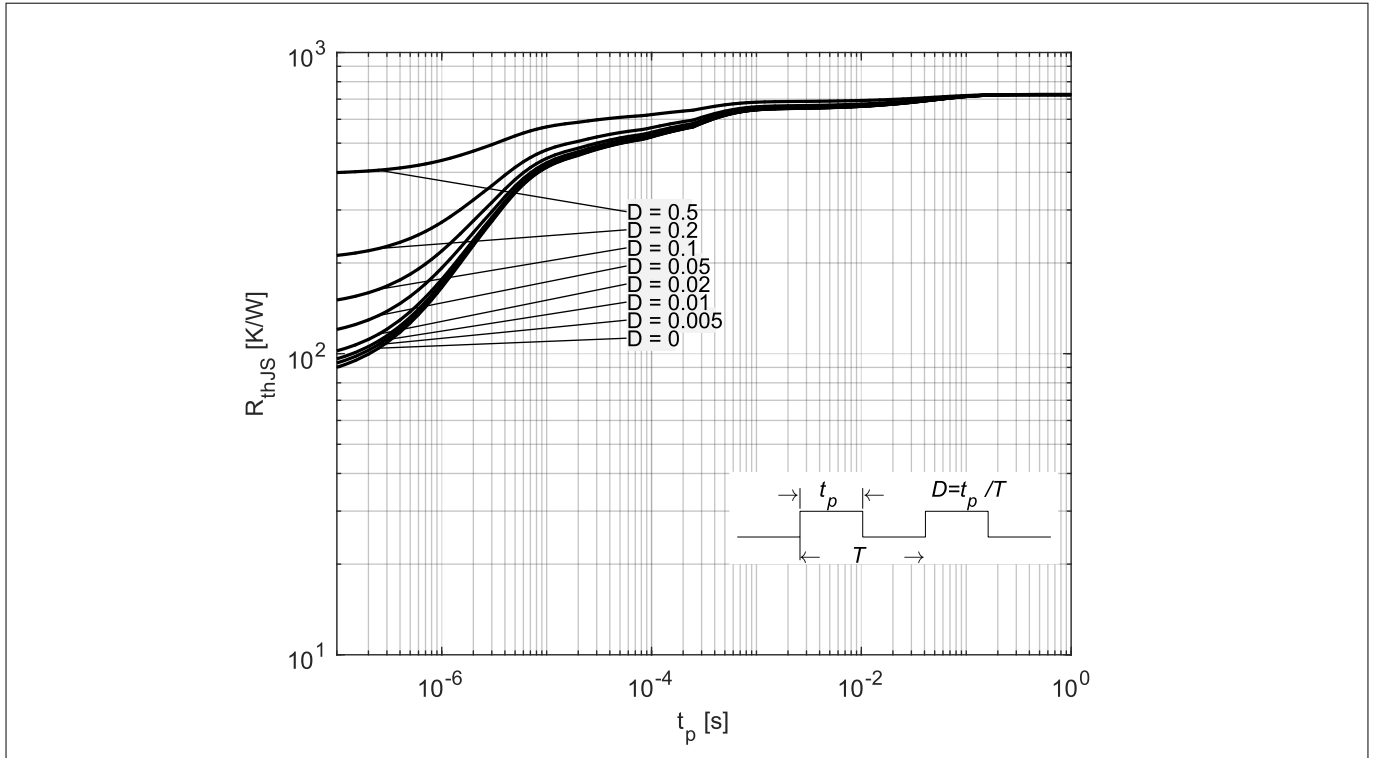

Figure 5 Thermal resistance R_{thJS} in pulse operation

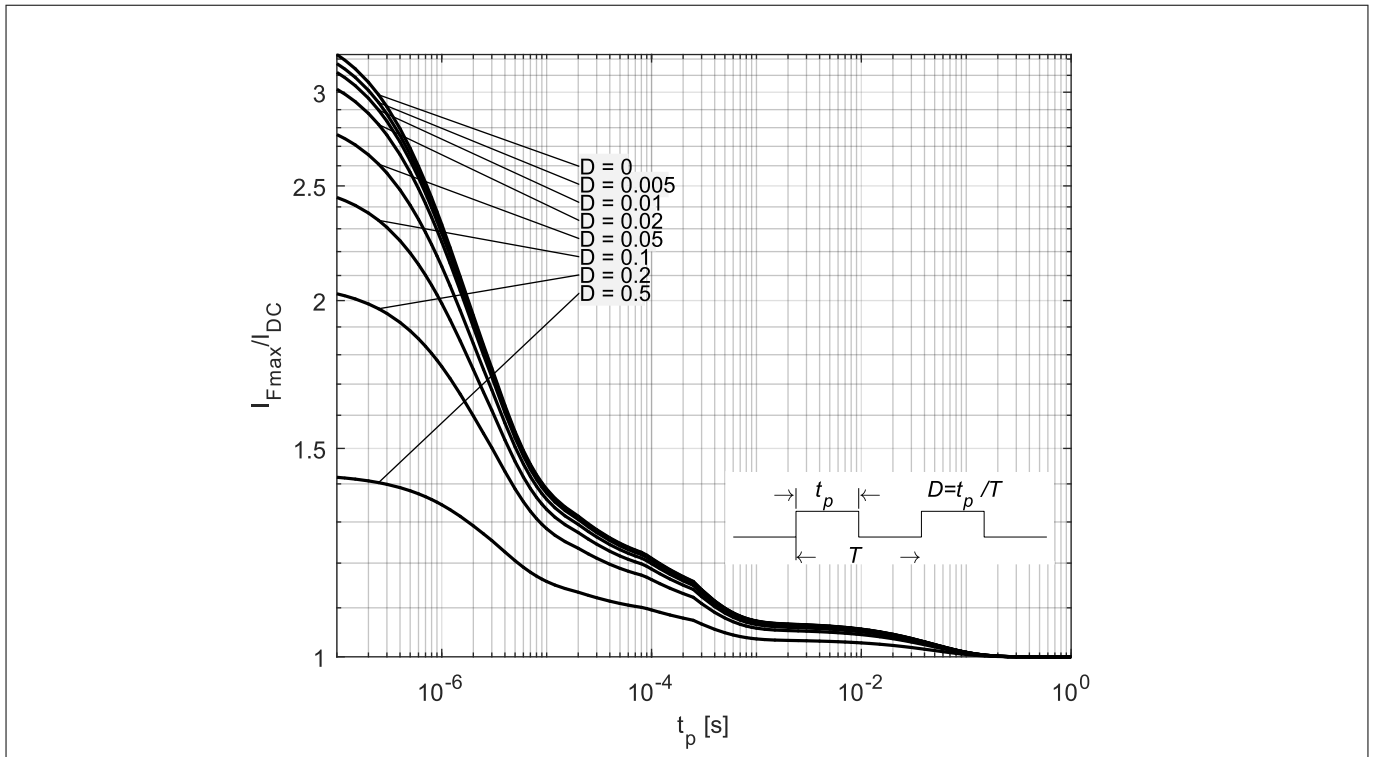

Figure 6 Permissible forward current ratio I_{Fmax}/I_{DC} in pulse operation

4 Package information SOT23-3

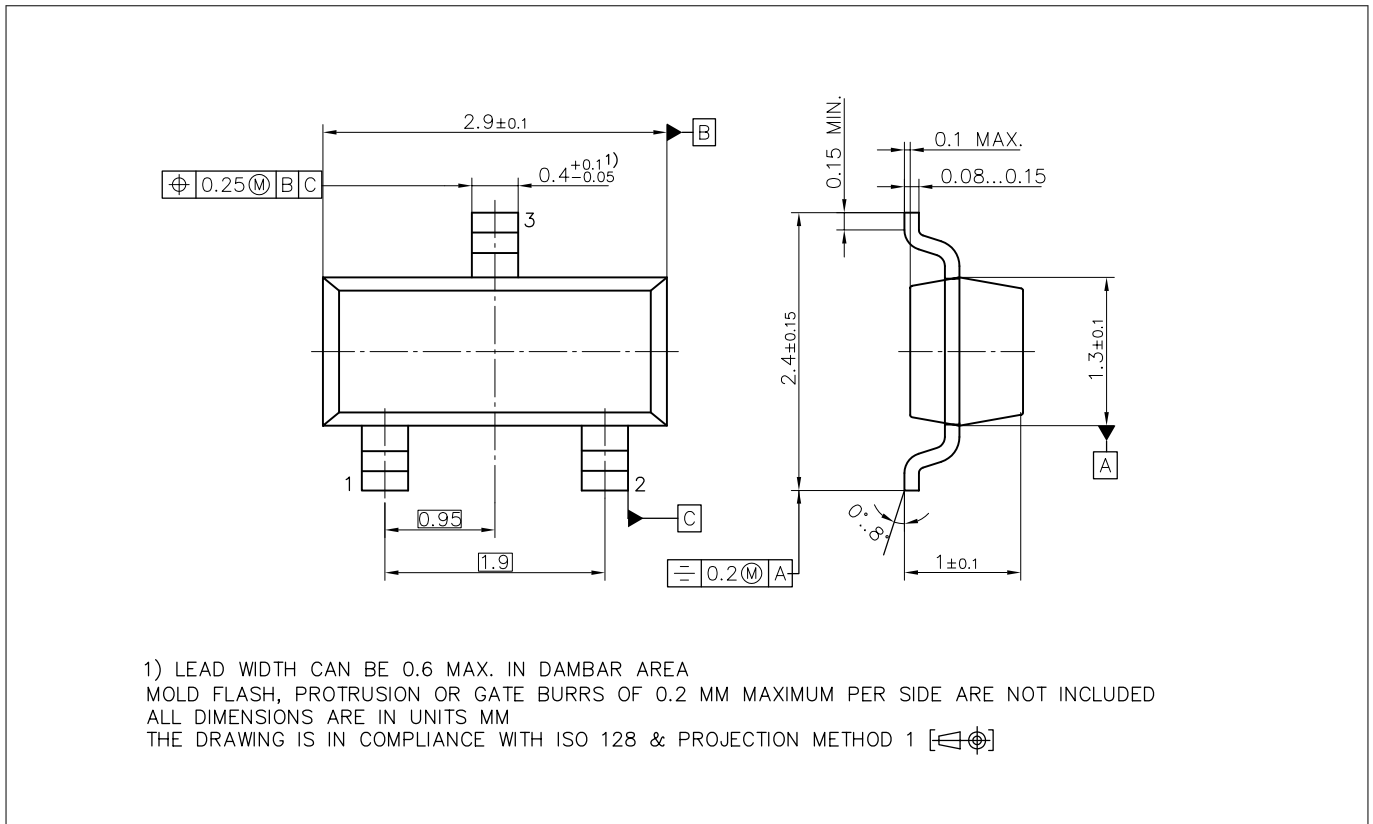

Figure 7 SOT23-3 package

Note: For package information including footprint, packing and assembly recommendation refer to:

<https://www.infineon.com/cms/en/product/packages/PG-SOT23/PG-SOT23-3-16/>

Revision history

Document version	Date of release	Description of changes
2.00	2018-09-28	<ul style="list-style-type: none"> New layout of datasheet Typical values and curves updated to the values of the production (No product or process change behind) Maximum/typical values added
2.01	2020-07-09	<ul style="list-style-type: none"> Scale of typical IF(VF) curve corrected
2.02	2022-09-29	<ul style="list-style-type: none"> Feature list updated

Trademarks

All referenced product or service names and trademarks are the property of their respective owners.

Edition 2022-09-29

Published by

Infineon Technologies AG

81726 Munich, Germany

© 2022 Infineon Technologies AG

All Rights Reserved.

Do you have a question about any aspect of this document?

Email: erratum@infineon.com

Document reference

IFX-buq1515511110421

Important notice

The information given in this document shall in no event be regarded as a guarantee of conditions or characteristics ("Beschaffheitsgarantie").

With respect to any examples, hints or any typical values stated herein and/or any information regarding the application of the product, Infineon Technologies hereby disclaims any and all warranties and liabilities of any kind, including without limitation warranties of non-infringement of intellectual property rights of any third party.

In addition, any information given in this document is subject to customer's compliance with its obligations stated in this document and any applicable legal requirements, norms and standards concerning customer's products and any use of the product of Infineon Technologies in customer's applications.

The data contained in this document is exclusively intended for technically trained staff. It is the responsibility of customer's technical departments to evaluate the suitability of the product for the intended application and the completeness of the product information given in this document with respect to such application.

Warnings

Due to technical requirements products may contain dangerous substances. For information on the types in question please contact your nearest Infineon Technologies office.

Except as otherwise explicitly approved by Infineon Technologies in a written document signed by authorized representatives of Infineon Technologies, Infineon Technologies' products may not be used in any applications where a failure of the product or any consequences of the use thereof can reasonably be expected to result in personal injury.

Looking for pricing, stock, or lifecycle information?

Click below to explore more details on WIN SOURCE:

-  [View BAT 60A E6327 on WIN SOURCE](#)
-  [Infineon Technologies](#) Information

Optimize Your Supply Chain with WIN SOURCE Solutions

-  Global Sourcing Solution
-  Obsolete Management
-  Cost Control Management
-  Shortage Management
-  Alternative Solution
-  Excess Inventory Management