



# THE DATASHEET OF KBP201G



## Features and Benefits

- Glass Passivated Die Construction
- High Case Dielectric Strength of 1,500 V<sub>RMS</sub>
- Low Reverse Leakage Current
- Surge Overload Rating to 65A Peak
- Ideal for Printed Circuit Board Applications
- UL Listed Under Recognized Component Index, File Number E94661
- **Lead-Free Finish; RoHS Compliant (Notes 1 & 2)**

## Mechanical Data

- Case: KBP
- Case Material: Molded Plastic. UL Flammability Classification Rating 94V-0
- Moisture Sensitivity: Level 1 per J-STD-020
- Terminals: Finish – Tin Plated Leads. Solderable per MIL-STD-202, Method 208
- Polarity: Marked on Body
- Marking: Type Number
- Weight: 1.52 grams (Approximate)

KBP



## Ordering Information (Note 3)

Part Number	Compliance	Case	Packaging
KBP2005G	Commercial	KBP	35 Pieces per Tube
KBP201G	Commercial	KBP	35 Pieces per Tube
KBP202G	Commercial	KBP	35 Pieces per Tube
KBP204G	Commercial	KBP	35 Pieces per Tube
KBP206G	Commercial	KBP	35 Pieces per Tube
KBP208G	Commercial	KBP	35 Pieces per Tube
KBP210G	Commercial	KBP	35 Pieces per Tube

- Notes:
1. EU Directive 2002/95/EC (RoHS) & 2011/65/EU (RoHS 2) compliant. All applicable RoHS exemptions applied.
  2. See [http://www.diodes.com/quality/lead\\_free.html](http://www.diodes.com/quality/lead_free.html) for more information about Diodes Incorporated's definitions of Halogen- and Antimony-free, "Green" and Lead-free.
  3. For packaging details, go to our website at <http://www.diodes.com/products/packages.html>.

## Marking Information

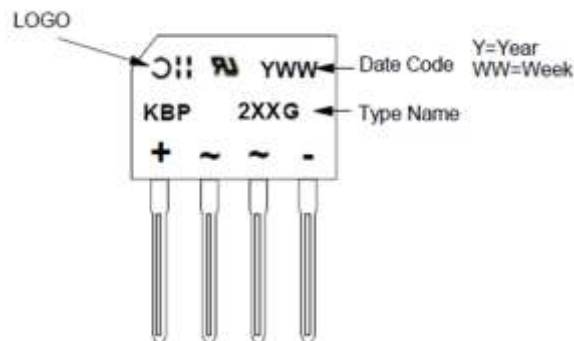

**Maximum Ratings** (@T<sub>A</sub> = +25°C, unless otherwise specified.)

Single phase, half wave, 60Hz, resistive or inductive load.  
For capacitance load, derate current by 20%.

Characteristic	Symbol	KBP2005G	KBP201G	KBP202G	KBP204G	KBP206G	KBP208G	KBP210G	Unit
Peak Repetitive Reverse Voltage	V <sub>RRM</sub>								
Working Peak Reverse Voltage	V <sub>RWM</sub>	50	100	200	400	600	800	1,000	V
DC Blocking Voltage	V <sub>RM</sub>								
RMS Reverse Voltage	V <sub>R(RMS)</sub>	35	70	140	280	420	560	700	V
Average Rectified Output Current @T <sub>C</sub> = +105°C	I <sub>O</sub>	2.0							A
Non-Repetitive Peak Forward Surge Current 8.3ms Single Half Sine-Wave Superimposed on Rated Load	I <sub>FSM</sub>	65							A
I <sup>2</sup> t Rating for Fusing (3ms ≤ t ≤ 8.3ms)	I <sup>2</sup> t	17.5							A <sup>2</sup> s

**Thermal Characteristics**

Characteristic	Symbol	Value	Unit
Typical Thermal Resistance, Junction to Case (Note 4)	R <sub>θJC</sub>	14	°C/W
Typical Thermal Resistance, Junction to Lead	R <sub>θJL</sub>	18	°C/W
Typical Thermal Resistance, Junction to Ambient	R <sub>θJA</sub>	40	°C/W
Operating and Storage Temperature Range	T <sub>J</sub> , T <sub>STG</sub>	-65 to +150	°C

**Electrical Characteristics** (@T<sub>A</sub> = +25°C, unless otherwise specified.)

Characteristic	Symbol	Min	Typ	Max	Unit	Test Condition
Reverse Breakdown Voltage (Note 5)	V <sub>(BR)R</sub>	KBP210G 1,000 KBP208G 800 KBP206G 600 KBP204G 400 KBP202G 200 KBP201G 100 KBP2005G 50	—	—	V	I <sub>R</sub> = 5μA
Forward Voltage Drop per Element	V <sub>F</sub>	—	—	1.1	V	I <sub>F</sub> = 2A, T <sub>J</sub> = +25°C
Leakage Current (Note 5)	I <sub>R</sub>	—	—	5 500	μA	V <sub>R</sub> = V <sub>RRM</sub> , T <sub>C</sub> = +25°C V <sub>R</sub> = V <sub>RRM</sub> , T <sub>C</sub> = +125°C
Total Capacitance per Element	C <sub>T</sub>	—	25	—	pF	V <sub>R</sub> = 4.0V <sub>DC</sub> , f = 1MHz

Notes: 4. Thermal resistance from junction to case per element. Device mounted on 75mm x 75mm x 1.6mm Cu Plate Heatsink.  
5. Short duration pulse test used to minimize self-heating effect.

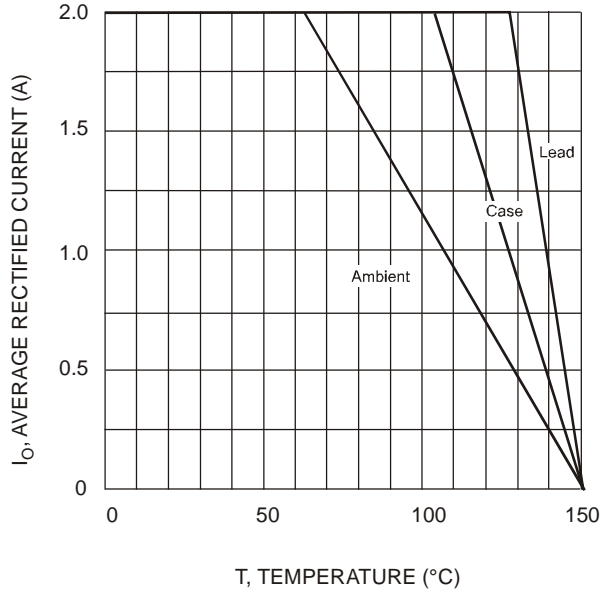

Fig. 1 Forward Current Derating Curve

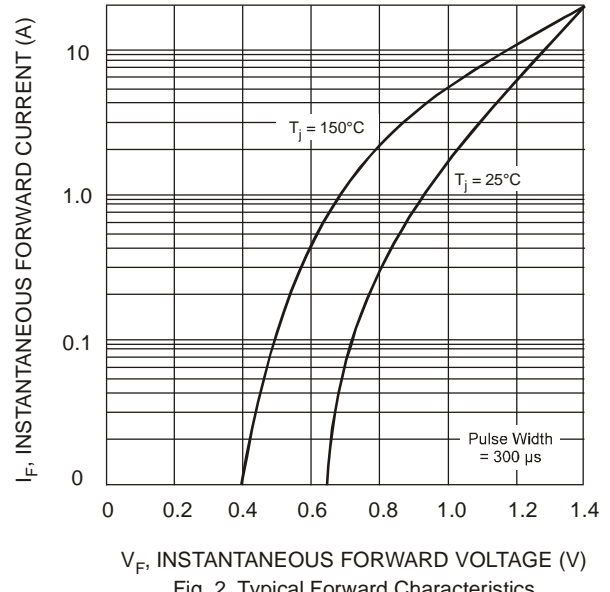

Fig. 2 Typical Forward Characteristics

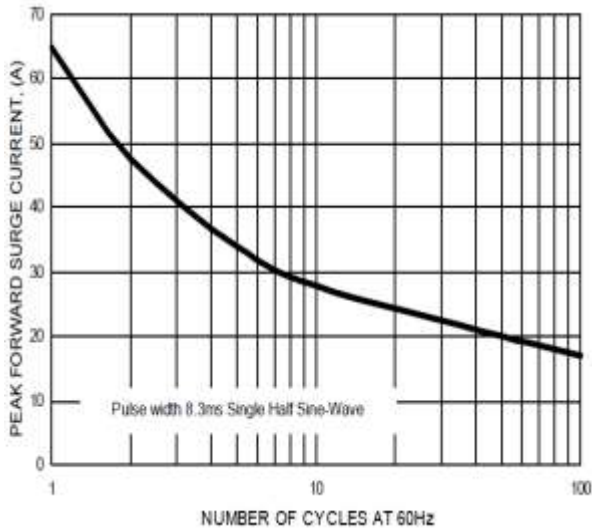

Fig. 3 Maximum Non-Repetitive Surge Current

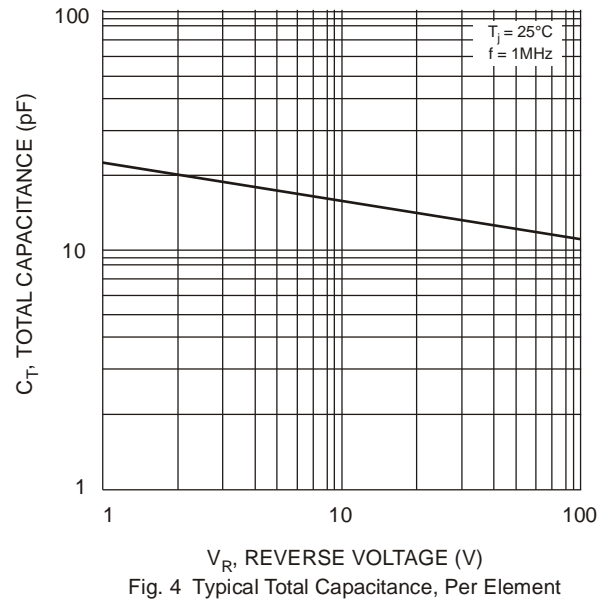

Fig. 4 Typical Total Capacitance, Per Element

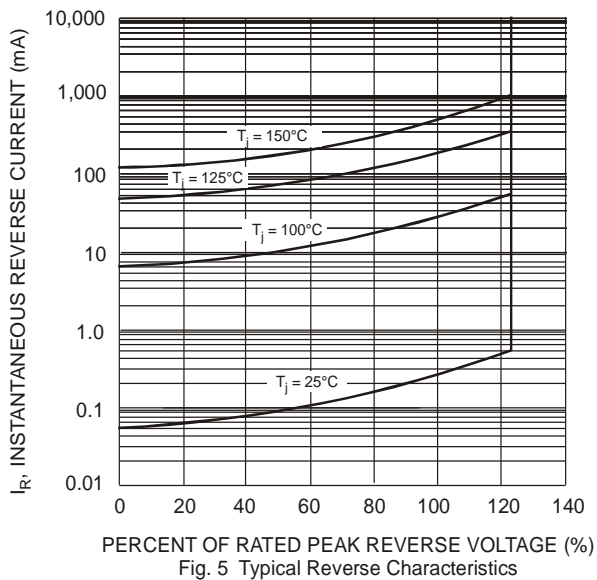

Fig. 5 Typical Reverse Characteristics

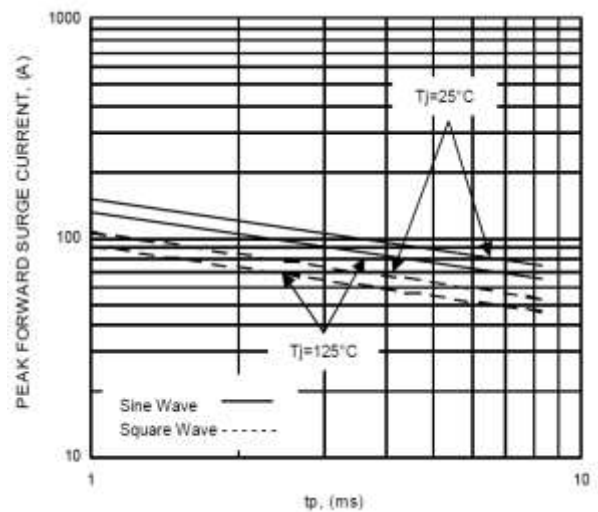
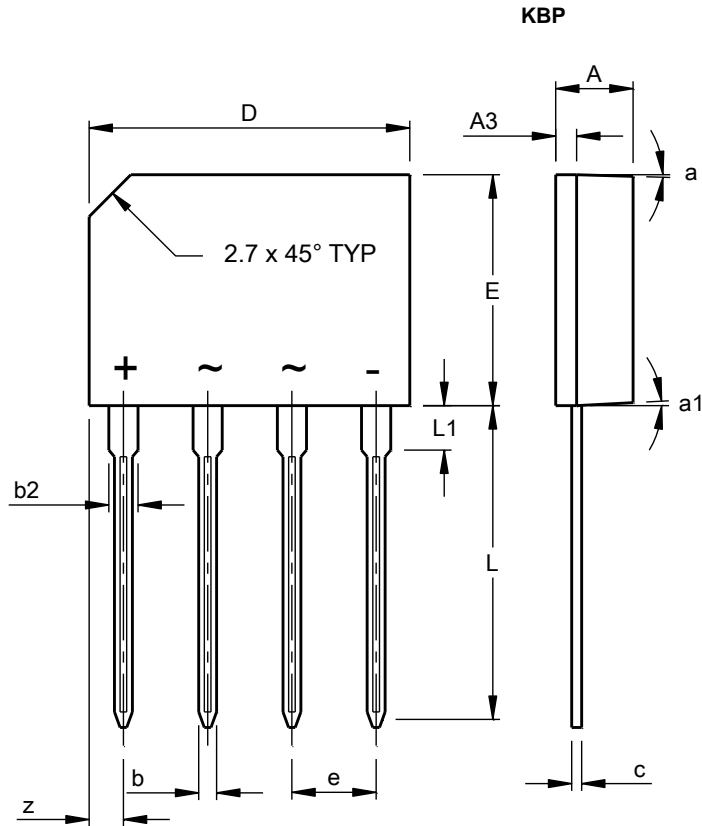

Fig. 6 Non-Repetitive Surge Current

**Package Outline Dimensions**

Please see <http://www.diodes.com/package-outlines.html> for the latest version.



KBP			
Dim	Min	Max	Typ
A	3.35	3.65	-
A3	0.80	1.10	-
b	0.76	0.86	-
b2	1.22	1.42	-
c	0.35	0.55	-
D	14.25	14.75	-
E	10.20	10.60	-
e	3.56	4.06	-
L	14.25	14.73	-
L1	1.80	2.20	-
z	1.40	1.70	-
a	-	-	3°
a1	-	-	2°
All Dimensions in mm			

**IMPORTANT NOTICE**

DIODES INCORPORATED MAKES NO WARRANTY OF ANY KIND, EXPRESS OR IMPLIED, WITH REGARDS TO THIS DOCUMENT, INCLUDING, BUT NOT LIMITED TO, THE IMPLIED WARRANTIES OF MERCHANTABILITY AND FITNESS FOR A PARTICULAR PURPOSE (AND THEIR EQUIVALENTS UNDER THE LAWS OF ANY JURISDICTION).

Diodes Incorporated and its subsidiaries reserve the right to make modifications, enhancements, improvements, corrections or other changes without further notice to this document and any product described herein. Diodes Incorporated does not assume any liability arising out of the application or use of this document or any product described herein; neither does Diodes Incorporated convey any license under its patent or trademark rights, nor the rights of others. Any Customer or user of this document or products described herein in such applications shall assume all risks of such use and will agree to hold Diodes Incorporated and all the companies whose products are represented on Diodes Incorporated website, harmless against all damages.

Diodes Incorporated does not warrant or accept any liability whatsoever in respect of any products purchased through unauthorized sales channel. Should Customers purchase or use Diodes Incorporated products for any unintended or unauthorized application, Customers shall indemnify and hold Diodes Incorporated and its representatives harmless against all claims, damages, expenses, and attorney fees arising out of, directly or indirectly, any claim of personal injury or death associated with such unintended or unauthorized application.

Products described herein may be covered by one or more United States, international or foreign patents pending. Product names and markings noted herein may also be covered by one or more United States, international or foreign trademarks.

This document is written in English but may be translated into multiple languages for reference. Only the English version of this document is the final and determinative format released by Diodes Incorporated.

**LIFE SUPPORT**

Diodes Incorporated products are specifically not authorized for use as critical components in life support devices or systems without the express written approval of the Chief Executive Officer of Diodes Incorporated. As used herein:

A. Life support devices or systems are devices or systems which:

1. are intended to implant into the body, or
2. support or sustain life and whose failure to perform when properly used in accordance with instructions for use provided in the labeling can be reasonably expected to result in significant injury to the user.

B. A critical component is any component in a life support device or system whose failure to perform can be reasonably expected to cause the failure of the life support device or to affect its safety or effectiveness.

Customers represent that they have all necessary expertise in the safety and regulatory ramifications of their life support devices or systems, and acknowledge and agree that they are solely responsible for all legal, regulatory and safety-related requirements concerning their products and any use of Diodes Incorporated products in such safety-critical, life support devices or systems, notwithstanding any devices- or systems-related information or support that may be provided by Diodes Incorporated. Further, Customers must fully indemnify Diodes Incorporated and its representatives against any damages arising out of the use of Diodes Incorporated products in such safety-critical, life support devices or systems.

Copyright © 2017, Diodes Incorporated

[www.diodes.com](http://www.diodes.com)

## Looking for pricing, stock, or lifecycle information?

Click below to explore more details on WIN SOURCE:

-  [View KBP201G on WIN SOURCE](#)
-  [Diodes Incorporated Information](#)

## Optimize Your Supply Chain with WIN SOURCE Solutions

-  Global Sourcing Solution
-  Obsolete Management
-  Cost Control Management
-  Shortage Management
-  Alternative Solution
-  Excess Inventory Management