

Zynq UltraScale+ Device Packaging and Pinouts

Product Specification User Guide

UG1075 (v1.13) October 11, 2024

AMD Adaptive Computing is creating an environment where employees, customers, and partners feel welcome and included. To that end, we're removing non-inclusive language from our products and related collateral. We've launched an internal initiative to remove language that could exclude people or reinforce historical biases, including terms embedded in our software and IPs. You may still find examples of non-inclusive language in our older products as we work to make these changes and align with evolving industry standards. Follow this [link](#) for more information.





Table of Contents

Chapter 1: Packaging Overview

Introduction to the UltraScale Architecture	7
Zynq UltraScale+ Device Packaging and Pinouts	8
Differences from Previous Generations	8
Device/Package Combinations	9
Gigabit Transceiver Channels by Device/Package	11
User I/O Pins by Device/Package	16
Pin Definitions	22
Footprint Compatibility between Packages	30
Die Level Bank Numbering Overview	48

Chapter 2: PS Memory Interface Pin Guidelines

Introduction to PS Memory Interface Pins	105
DDR3/3L Guidelines	105
DDR4 Guidelines	109
LPDDR4 Guidelines	116
LPDDR3 Guidelines	120

Chapter 3: Package Files

About ASCII Package Files	126
Package Specifications Designations	127
ASCII Pinout Files	127

Chapter 4: Device Diagrams

Summary	132
SBVA484 Package—XCZU1CG, XCZU1EG, XAZU1EG	138
SBVA484 Package—XCZU2CG, XCZU2EG, XCZU3CG, XCZU3EG, XAZU2EG, and XAZU3EG	140
UBVA494 Package—XCZU1CG, XCZU1EG	142
UBVA530 Package—XCZU2CG, XCZU2EG, XCZU3CG, and XCZU3EG	144
SFVA625 Package—XCZU1CG, XCZU1EG, XAZU1EG	146
SFVA625 Package—XCZU2CG, XCZU2EG, XCZU3CG, XCZU3EG, XAZU2EG, and XAZU3EG	148
SFVC784 Package—XCZU1CG, XCZU1EG, XAZU1EG	150
SFVC784 Package—XCZU2CG, XCZU2EG, XCZU3CG, XCZU3EG, XAZU2EG, and XAZU3EG	152



SFVC784 Package–XCZU3TCG and XCZU3TEG	154
SFVD784 Package–XCZU3TCG and XCZU3TEG	156
SFVC784 Package–XCZU4CG, XCZU4EG, XCZU5CG, and XCZU5EG	158
SFVC784 Package–XCZU4EV, XCZU5EV, XAZU4EV, and XAZU5EV	160
SFVE784 Package–XCZU4CG, XCZU4EG, XCZU5CG, and XCZU5EG	162
SFVE784 Package–XCZU4EV and XCZU5EV	164
FBVB900 Package–XCZU4CG, XCZU4EG, XCZU5CG, and XCZU5EG	166
FBVB900 Package–XCZU4EV and XCZU5EV	168
FBVB900 Package–XCZU7CG and XCZU7EG	170
FBVB900 Package–XCZU7EV	172
FFVC900 Package–XCZU6CG, XCZU6EG, XCZU9CG, XCZU9EG, and XCZU15EG	174
FFVB1156 Package–XCZU6CG, XCZU6EG, XCZU9CG, XCZU9EG, and XCZU15EG	176
FFVC1156 Package–XCZU7CG and XCZU7EG	178
FFVC1156 Package–XCZU7EV	180
FFVC1156 Package–XCZU11EG	182
FFVD1156 Package–XCZU21DR	184
FFVE1156 and FSVE1156 Packages–XCZU25DR	186
FFVE1156 and FSVE1156 Packages–XCZU27DR and XCZU28DR	188
FFVE1156 and FSVE1156 Packages–XCZU42DR	190
FFVE1156 and FSVE1156 Packages–XCZU43DR	192
FFVE1156 and FSVE1156 Packages–XCZU47DR	194
FFVE1156 and FSVE1156 Packages–XCZU48DR and XQZU48DR	196
FFVE1156 and FSVE1156 Packages–XCZU63DR	198
FFVE1156 and FSVE1156 Packages–XCZU64DR	200
FFVE1156 and FSVE1156 Packages–XCZU65DR	202
FFVE1156 and FSVE1156 Packages–XCZU67DR	204
FFVB1517 Package–XCZU11EG	206
FFVB1517 Package–XCZU17EG and XCZU19EG	208
FFVF1517 Package–XCZU7CG and XCZU7EG	210
FFVF1517 Package–XCZU7EV	212
FFVF1517 Package–XCZU11EG	214
FFVG1517 and FSVG1517 Packages–XCZU25DR	216
FFVG1517 and FSVG1517 Packages–XCZU27DR and XCZU28DR	218
FFVG1517 and FSVG1517 Packages–XCZU43DR	220
FFVG1517 and FSVG1517 Packages–XCZU47DR	222
FFVG1517, FSVG1517 Packages–XCZU48DR FSRG1517 Package–XQZU48DR	224
FFVC1760 Package–XCZU11EG	226
FFVC1760 Package–XCZU17EG and XCZU19EG	228
FFVD1760 Package–XCZU17EG and XCZU19EG	230
FFVF1760 and FSVF1760 Packages–XCZU29DR and XCZU39DR	232



FFVF1760 and FSVF1760 Packages–XCZU49DR FSRF1760 Package–XQZU49DR	234
FFVH1760 and FSVH1760 Packages–XCZU46DR	236
FFVE1924 Package–XCZU17EG and XCZU19EG	238

Chapter 5: Mechanical Drawings

Summary.....	240
SBVA484 Flip-Chip, Super-Fine-Pitch BGA (XCZU1CG, XCZU1EG, and XAZU1EG)	246
SBVA484 Flip-Chip, Super-Fine-Pitch BGA (XCZU2, XCZU3, XAZU2EG, and XAZU3EG)	247
SFRA484 Flip-Chip, Super-Fine-Pitch BGA (XQZU3EG).....	248
UBVA494 Flip-Chip, InFO BGA (XCZU1)	249
UBVA530 Flip-Chip, InFO BGA (XCZU2, XCZU3)	250
SFVA625 Flip-Chip, Super-Fine-Pitch BGA (XCZU1CG, XCZU1EG, and XAZU1EG)	251
SFVA625 Flip-Chip, Super-Fine-Pitch BGA (XCZU2, XCZU3, XAZU2EG, and XAZU3EG)	252
SFRC784 Ruggedized Flip-Chip, Super-Fine-Pitch, BGA (XQZU3EG and XQZU5EV)	253
SFVC784, SFVD784, and SFVE784, Flip-Chip, Super-Fine-Pitch BGA (XCZU1, XAZU1EG, XCZU2, XAZU2EG, XCZU3, XAZU3EG, XCZU3T, XCZU4, XAZU4EV, XCZU5, and XAZU5EV).....	254
FBVB900 Flip-Chip, Fine-Pitch BGA (XCZU4CG, XCZU4EG, XCZU4EV, XCZU5CG, XCZU5EG, and XCZU5EV)	255
FBVB900 Flip-Chip, Fine-Pitch BGA (XCZU7CG, XCZU7EG, XCZU7EV, and XAZU7EV)	256
FFRB900 (XQZU7EV) Ruggedized Flip-Chip Fine-Pitch BGA.....	257
FFRB900 (XQZU5EV) and FFRC900 (XQZU9EG and XQZU15EG) Ruggedized Flip-Chip Fine-Pitch BGA 258	
FFVC900 Flip-Chip, Fine-Pitch BGA (XCZU6CG, XCZU6EG, XCZU9CG, XCZU9EG, and XCZU15EG).	259
FFRB1156 Ruggedized Flip-Chip, Fine-Pitch, BGA (XQZU9EG and XQZU15EG)	260
FFVB1156 Flip-Chip, Fine-Pitch BGA (XCZU6CG, XCZU6EG, XCZU9CG, XCZU9EG, and XCZU15EG)	261
FFRC1156 Ruggedized Flip-Chip Fine-Pitch BGA (XQZU7EV and XQZU11EG)	262
FFVC1156 Flip-Chip, Fine-Pitch BGA (XCZU7CG, XCZU7EG, XCZU7EV, and XCZU11EG).....	263
FFRD1156 (XQZU21DR) Ruggedized Flip-Chip Fine-Pitch BGA	264
FFRE1156 (XQZU28DR, XQZU48DR) Ruggedized Flip-Chip Fine-Pitch BGA	265
FFVD1156 (XCZU21DR) and FFVE1156 (XCZU25DR, XCZU27DR, XCZU42DR, XCZU48DR, XCZU63DR, XCZU64DR, XCZU65DR, XCZU67DR) Flip-Chip, Fine-Pitch BGA	266
FSVE1156 (XCZU25DR, XCZU27DR, XCZU28DR, XCZU43DR, XCZU47DR, XCZU48DR) Flip-Chip, Fine-Pitch, Lidless w/Stiffener Ring BGA	267
FSVE1156 (XCZU42DR, XCZU63DR, XCZU64DR, XCZU65DR, XCZU67DR) Flip-Chip, Fine-Pitch, Lidless w/Stiffener Ring BGA.....	268
FFRB1517 (XQZU19EG) Ruggedized Flip-Chip Fine-Pitch BGA	269
FFVB1517 (XCZU11EG, XCZU17EG, and XCZU19EG) and FFVF1517 (XCZU7CG, XCZU7EG, XCZU7EV, XCZU11EG, and XAZU11EG) Flip-Chip, Fine-Pitch BGA	270
FFRG1517 (XQZU28DR) Ruggedized Flip-Chip Fine-Pitch BGA	271



FFVG1517 (XCZU25DR, XCZU27DR, XCZU28DR, XCZU43DR, XCZU47DR, XCZU48DR) Flip-Chip, Fine-Pitch BGA	272
FSRG1517 (XQZU48DR) Ruggedized Flip Chip, Fine-Pitch, Lidless with Stiffener Ring BGA	273
FSVG1517 (XCZU25DR, XCZU27DR, XCZU28DR, XCZU43DR, XCZU47DR, XCZU48DR) Flip-Chip, Fine-Pitch, Lidless with Stiffener Ring BGA	274
FFVC1760 and FFVD1760 Flip-Chip, Fine-Pitch BGA (XCZU11EG, XCZU17EG, and XCZU19EG)	275
FFRC1760 Ruggedized Flip-Chip BGA (XQZU11EG and XQZU19EG)	276
FFVF1760 (XCZU29DR, XCZU39DR, XCZU49DR) and FVVH1760 (XCZU46DR) Flip-Chip, Fine-Pitch BGA 277	
FFRF1760 (XQZU29DR) Ruggedized Flip-Chip Fine-Pitch BGA.	278
FSVF1760 (XCZU29DR, XCZU39DR, XCZU49DR) and FSVH1760 (XCZU46DR) Flip-Chip, Fine-Pitch, Lidless with Stiffener Ring BGA.	279
FSRF1760 (XQZU49DR) Ruggedized Flip Chip, Fine-Pitch Lidless with Stiffener Ring BGA	280
FFVE1924 Flip-Chip, Fine-Pitch BGA (XCZU17EG, and XCZU19EG)	281
Chapter 6: Package Marking	
Introduction	282
Chapter 7: Packing and Shipping	
Introduction	286
Chapter 8: Soldering Guidelines	
Soldering Guidelines	287
Strain Gauge Measurement	293
Solder Paste	294
Component Placement	294
Chapter 9: Recommended PCB Design Rules for BGA Packages	
BGA Packages	296
Stencil	298
Chapter 10: Edge Bonding and Underfill Guidelines	
Summary.	300
Edge Bonding Implementation	301
Edge Bond Removal	304
Underfill Guidelines	304
Conformal Coating	312



Chapter 11: Thermal Specifications

Introduction	313
Thermal Resistance Data	314
Support for Thermal Models	319

Chapter 12: Thermal Management Strategy

Introduction	320
Thermal Interface Material	322
Heat Sink Removal	325
Measurement Debug	327

Chapter 13: Heat Sink Guidelines for Bare-die Flip-Chip Packages

Heat Sink Attachments for Bare-die FB Packages	328
Types of Heat Sink Attachments	329

Appendix A: Additional Resources and Legal Notices

Finding Additional Documentation	334
Support Resources	335
References	335
Revision History	337
Please Read: Important Legal Notices	343

Packaging Overview

Introduction to the UltraScale Architecture

The AMD UltraScale™ architecture is the first ASIC-class architecture to enable multi-hundred gigabit-per-second levels of system performance with smart processing, while efficiently routing and processing data on-chip. UltraScale architecture-based devices address a vast spectrum of high-bandwidth, high-utilization system requirements by using industry-leading technical innovations, including next-generation routing, ASIC-like clocking, 3D-on-3D ICs, multiprocessor SoC (MPSoC) technologies, and new power reduction features. The devices share many building blocks, providing scalability across process nodes and product families to leverage system-level investment across platforms.

Artix™ UltraScale+™ devices provide high serial bandwidth and signal compute density in a cost-optimized device for critical networking applications, vision and video processing, and secured connectivity. Coupled with the innovative InFO packaging, which provides excellent thermal and power distribution, Artix UltraScale+ FPGAs are perfectly suited to applications requiring high compute density in a small footprint.

Virtex™ UltraScale+ devices provide the highest performance and integration capabilities in a FinFET node, including both the highest serial I/O and signal processing bandwidth, as well as the highest on-chip memory density. As the industry's most capable FPGA family, the Virtex UltraScale+ devices are ideal for applications including 1+Tb/s networking and data center and fully integrated radar/early-warning systems.

Kintex™ UltraScale+ devices provide the best price/performance/watt balance in a FinFET node, delivering the most cost-effective solution for high-end capabilities, including transceiver and memory interface line rates as well as 100G connectivity cores. Our newest mid-range family is ideal for both packet processing and DSP-intensive functions and is well suited for applications including wireless MIMO technology, Nx100G networking, and data center.

Zynq™ UltraScale+ MPSoC devices provide 64-bit processor scalability while combining real-time control with soft and hard engines for graphics, video, waveform, and packet processing. Integrating an Arm®-based system for advanced analytics and on-chip programmable logic for task acceleration creates unlimited possibilities for applications including 5G Wireless, next generation ADAS, and Industrial Internet-of-Things.

Zynq UltraScale+ RFSoc integrate the key subsystems required to implement a complete software-defined radio including direct RF sampling data converters, enabling CPRI and

gigabit Ethernet-to-RF on a single, highly programmable SoC. Each device offers multiple RF-sampling analog-to-digital (RF-ADC) and RF-sampling digital-to-analog (RF-DAC) data converters. The data converters are high-precision, high-speed and power efficient.

For the latest Zynq UltraScale+ device descriptions, specifications, data sheets, and user guides are available at docs.amd.com.

Zynq UltraScale+ Device Packaging and Pinouts

This section describes the packages and pinouts for the in various organic flip-chip 0.5 mm, 0.8 mm, and 1.0 mm pitch BGA packages.



IMPORTANT: All standard packages are lead-free (signified by an additional V in the package name). All devices supported in a particular package are footprint compatible. Each device is split into I/O banks to allow for flexibility in the choice of I/O standards. See the *UltraScale Architecture SelectIO Resources User Guide (UG571)*.

The flip-chip assembly materials for the Zynq UltraScale+ devices are manufactured using ultra-low alpha (ULA) materials defined as <math><0.002\text{ cph/cm}^2</math> or materials that emit less than 0.002 alpha-particles per square centimeter per hour.



IMPORTANT: All non-InFO packages are available with eutectic BGA balls. To order these packages, the device type starts with an XQ vs. XC or XA, and the Pb-free signifier in the package name is Q.

Differences from Previous Generations

The packaging and pinout specifications for Zynq UltraScale+ devices differ from past generations, including the Zynq-7000 SoCs. These details are outlined in this section.

- All package and die components, including flip-chip solder bumps, are lead-free.
- Package names contain a single-character alphabetic designator followed by the exact number of pins found on the package.
- VCCAUX_IO pins are not divided into bank groups. VCCAUX_IO must be connected to VCCAUX at the board level.
- Internal logic is separated from I/O logic by the addition of the VCCINT_IO power pins. VCCINT_IO must be connected to VCCBRAM (depending on the device speed grade and voltage settings) at the board level.
- Groups of gigabit serial transceiver (GT) power pins are separated by column for each column of GT Quads.

- Standard HP I/O banks each have a total of 52 SelectIO™ pins, optionally configurable as (up to) 24 differential pairs.
- Standard HD I/O banks each have a total of 24 SelectIO pins, optionally configurable as (up to) 12 differential pairs.
- Each bank has one dedicated VREF pin. These pins cannot be used as user I/Os.
- Four differential clock pin pairs per bank consist of a single type of global clock (GC or HDGC) input.
- Four memory byte groups per HP I/O bank are each separated into an upper and a lower memory byte group.
- Multiple PL configuration pins are removed.
- A POR_OVERRIDE pin is used to override the default power-on-reset delay. See [Table 1-4](#).

Device/Package Combinations

[Table 1-1](#) shows the size and BGA pitch of the Zynq UltraScale+ device packages. All non-InFO packages are available with eutectic BGA balls. For these packages, the Pb-free signifier in the package name is a Q.

Table 1-1: Package Specifications

Packages	Description	Package Specifications		
		Package Type	Pitch (mm)	Size (mm)
UBVA494	Flip-chip, integrated fan out (InFO), bare-die	BGA	0.5	15 x 9.5
UBVA530	Flip-chip, integrated fan out (InFO), bare-die			16 x 9.5
SBVA484	Flip-chip, super-fine-pitch, bare-die		0.8	19 x 19
SFRA484	Ruggedized flip-chip, super-fine-pitch			19 x 19
SBVA625	Flip-chip, super-fine-pitch, bare-die			21 x 21
SFVA625	Flip-chip, super-fine-pitch			23 x 23
SFVC784	Flip-chip, super-fine-pitch			
SFRC784	Ruggedized flip-chip, super-fine-pitch			
SFVD784	Flip-chip, super-fine-pitch			
SFVE784	Flip-chip, super-fine-pitch		1.0	31 x 31
FBVB900	Flip-chip, fine-pitch, bare-die			
FFRB900	Ruggedized flip-chip, fine-pitch			
FFVC900	Flip-chip, fine-pitch			
FFRC900	Ruggedized flip-chip, fine-pitch			

Table 1-1: Package Specifications (Cont'd)

Packages	Description	Package Specifications			
		Package Type	Pitch (mm)	Size (mm)	
FFVB1156	Flip-chip, fine-pitch	BGA	1.0	35 x 35	
FFRB1156	Ruggedized flip-chip, fine-pitch				
FFVC1156	Flip-chip, fine-pitch				
FFRC1156	Ruggedized flip-chip, fine-pitch				
FFVD1156	Flip-chip, fine-pitch				
FFRD1156	Ruggedized flip-chip, fine-pitch				
FFVE1156	Flip-chip, fine-pitch				
FFRE1156	Ruggedized flip-chip, fine-pitch				
FFVB1517	Flip-chip, fine-pitch			40 x 40	
FFRB1517	Ruggedized flip-chip, fine-pitch				
FFVF1517	Flip-chip, fine-pitch				
FFVG1517	Flip-chip, fine-pitch				
FFRG1517	Ruggedized flip-chip, fine-pitch				
FFVC1760	Flip-chip, fine-pitch				42.5 x 42.5
FFRC1760	Ruggedized flip-chip, fine-pitch				
FFVD1760	Flip-chip, fine-pitch				
FFVF1760	Flip-chip, fine-pitch				
FFVH1760	Flip-chip, fine-pitch				
FFRF1760	Ruggedized flip-chip, fine-pitch				
FFVE1924	Flip-chip, fine-pitch			45 x 45	
FSVE1156	Flip-chip, fine-pitch, lidless with stiffener ring			35 x 35	
FSVG1517				40 x 40	
FSVF1760				42.5 x 42.5	
FSVH1760					
FSRG1517		40 x 40			
FSRF1760	Ruggedized ring flip-chip, fine-pitch, lidless with stiffener ring	42.5 x 42.5			

Gigabit Transceiver Channels by Device/Package

Table 1-2 lists the quantity of gigabit transceiver channels for the Zynq UltraScale+ devices. In all devices, a PS-GTR, GTH, or GTY channel is one set of MGTRXP, MGTRXN, MGTTXP, and MGTTXN pins. All non-InFO packages are available with eutectic BGA balls. For these packages, the device type is XQ and the Pb-free signifier in the package name is a Q.

Table 1-2: Serial Transceiver Channels (PS-GTR, GTH, and GTY) by Device/Package

Device	Package	PS-GTR Channels	GTH Channels	GTY Channels
XCZU1CG	SBVA484	4	0	0
XCZU1EG		4	0	0
XCZU2CG		4	0	0
XCZU2EG		4	0	0
XCZU3CG		4	0	0
XCZU3EG		4	0	0
XAZU1EG		4	0	0
XAZU2EG		4	0	0
XAZU3EG		4	0	0
XQZU3EG	SFRA484	4	0	0
XCZU1CG	UBVA494	4	0	0
XCZU1EG		4	0	0
XCZU2CG	UBVA530	4	0	0
XCZU2EG		4	0	0
XCZU3CG		4	0	0
XCZU3EG		4	0	0
XCZU1CG	SFVA625	4	0	0
XCZU1EG		4	0	0
XCZU2CG		4	0	0
XCZU2EG		4	0	0
XCZU3CG		4	0	0
XCZU3EG		4	0	0
XAZU1EG		4	0	0
XAZU2EG		4	0	0
XAZU3EG		4	0	0

Table 1-2: Serial Transceiver Channels (PS-GTR, GTH, and GTY) by Device/Package (Cont'd)

Device	Package	PS-GTR Channels	GTH Channels	GTY Channels
XCZU1CG	SFVC784	4	0	0
XCZU1EG		4	0	0
XCZU2CG		4	0	0
XCZU2EG		4	0	0
XCZU3CG		4	0	0
XCZU3EG		4	0	0
XCZU3TCG		4	4	0
XCZU3TEG		4	4	0
XCZU4CG		4	4	0
XCZU4EG		4	4	0
XCZU4EV		4	4	0
XCZU5CG		4	4	0
XCZU5EG		4	4	0
XCZU5EV		4	4	0
XAZU1EG		4	0	0
XAZU2EG		4	0	0
XAZU3EG		4	0	0
XAZU4EV		4	4	0
XAZU5EV		4	4	0
XQZU21DR		SFRC784	4	0
XQZU5EV	4	4	0	
XCZU3TCG	SFVD784	4	8	0
XCZU3TEG		4	8	0
XCZU4CG	SFVE784	4	8	0
XCZU4EG		4	8	0
XCZU4EV		4	8	0
XCZU5CG		4	8	0
XCZU5EG		4	8	0
XCZU5EV		4	8	0

Table 1-2: Serial Transceiver Channels (PS-GTR, GTH, and GTY) by Device/Package (Cont'd)

Device	Package	PS-GTR Channels	GTH Channels	GTY Channels
XCZU4CG	FBVB900	4	16	0
XCZU4EG		4	16	0
XCZU4EV		4	16	0
XCZU5CG		4	16	0
XCZU5EG		4	16	0
XCZU5EV		4	16	0
XCZU7CG		4	16	0
XCZU7EG		4	16	0
XCZU7EV		4	16	0
XAZU7EV		4	16	0
XQZU5EV		FFRB900	4	16
XQZU7EV	4		16	0
XCZU6CG	FFVC900	4	16	0
XCZU6EG		4	16	0
XCZU9CG		4	16	0
XCZU9EG		4	16	0
XCZU15EG		4	16	0
XQZU9EG	FFRC900	4	16	0
XQZU15EG		4	16	0
XCZU6CG	FFVB1156	4	24	0
XCZU6EG		4	24	0
XCZU9CG		4	24	0
XCZU9EG		4	24	0
XCZU15EG		4	24	0
XQZU9EG	FFRB1156	4	24	0
XQZU15EG		4	24	0
XCZU7CG	FFVC1156	4	20	0
XCZU7EG		4	20	0
XCZU7EV		4	20	0
XCZU11EG		4	20	0
XQZU7EV	FFRC1156	4	20	0
XQZU11EG		4	20	0
XCZU21DR	FFVD1156	4	0	16
XQZU21DR	FFRD1156	4	0	16

Table 1-2: Serial Transceiver Channels (PS-GTR, GTH, and GTY) by Device/Package (Cont'd)

Device	Package	PS-GTR Channels	GTH Channels	GTY Channels
XCZU25DR	FFVE1156	4	0	8
XCZU27DR		4	0	8
XCZU28DR		4	0	8
XCZU42DR		4	0	8
XCZU43DR		4	0	8
XCZU47DR		4	0	8
XCZU48DR		4	0	8
XCZU63DR		4	0	8
XCZU64DR		4	0	8
XCZU65DR		4	0	8
XCZU67DR		4	0	8
XQZU28DR	FFRE1156	4	0	8
XQZU48DR		4	0	8
XCZU25DR	FSVE1156	4	0	8
XCZU27DR		4	0	8
XCZU28DR		4	0	8
XCZU42DR		4	0	8
XCZU43DR		4	0	8
XCZU47DR		4	0	8
XCZU48DR		4	0	8
XCZU63DR		4	0	4
XCZU64DR		4	0	8
XCZU65DR		4	0	8
XCZU67DR		4	0	8
XCZU11EG	FFVB1517	4	16	0
XCZU17EG		4	16	0
XCZU19EG		4	16	0
XQZU19EG	FFRB1517	4	16	0
XCZU7CG	FFVF1517	4	24	0
XCZU7EG		4	24	0
XCZU7EV		4	24	0
XCZU11EG		4	32	0
XAZU11EG		4	32	0

Table 1-2: Serial Transceiver Channels (PS-GTR, GTH, and GTY) by Device/Package (Cont'd)

Device	Package	PS-GTR Channels	GTH Channels	GTY Channels
XCZU25DR	FFVG1517	4	0	8
XCZU27DR		4	0	16
XCZU28DR		4	0	16
XCZU43DR		4	0	16
XCZU47DR		4	0	16
XCZU48DR		4	0	16
XQZU28DR	FFRG1517	4	0	16
XCZU25DR	FSVG1517	4	0	8
XCZU27DR		4	0	16
XCZU28DR		4	0	16
XCZU43DR		4	0	16
XCZU47DR		4	0	16
XCZU48DR		4	0	16
XQZU48DR	FSRG1517	4	0	16
XCZU11EG	FFVC1760	4	32	16
XCZU17EG		4	32	16
XCZU19EG		4	32	16
XQZU11EG	FFRC1760	4	32	16
XQZU19EG		4	32	16
XCZU17EG	FFVD1760	4	44	28
XCZU19EG		4	44	28
XCZU29DR	FFVF1760	4	0	16
XCZU39DR		4	0	16
XCZU49DR		4	0	16
XCZU46DR	FFVH1760	4	0	16
XQZU29DR	FFRF1760	4	0	16
XCZU29DR	FSVF1760	4	0	16
XCZU39DR		4	0	16
XCZU49DR		4	0	16
XQZU49DR	FSRF1760	4	0	16
XCZU46DR	FSVH1760	4	0	16
XCZU17EG	FFVE1924	4	44	0
XCZU19EG		4	44	0

User I/O Pins by Device/Package

Table 1-3 lists the number of available PS I/Os, 3.3V-capable high-density (HD), and 1.8V-capable high-performance (HP) I/Os and the number of HD or HP differential I/O for each device/package combination. All non-InFO packages are available with eutectic BGA balls. For these packages, the device type is XQ and the Pb-free signifier in the package name is a Q.

Table 1-3: Available I/O Pins by Device/Package

Device	Package	PS I/Os	Total User I/O		Differential I/O	
			HD ⁽¹⁾	HP ⁽¹⁾	HD	HP
XCZU1CG	SBVA484	170	24	58	24	52
XCZU1EG		170	24	58	24	52
XCZU2CG		170	24	58	24	52
XCZU2EG		170	24	58	24	52
XCZU3CG		170	24	58	24	52
XCZU3EG		170	24	58	24	52
XAZU1EG		170	24	58	24	52
XAZU2EG		170	24	58	24	52
XAZU3EG		170	24	58	24	52
XQZU3EG	SFRA484	170	24	58	24	52
XCZU1CG	UBVA494	170	24	58	24	52
XCZU1EG		170	24	58	24	52
XCZU2CG	UBVA530	170	24	58	24	52
XCZU2EG		170	24	58	24	52
XCZU3CG		170	24	58	24	52
XCZU3EG		170	24	58	24	52
XCZU1CG	SFVA625	170	24	156	24	144
XCZU1EG		170	24	156	24	144
XCZU2CG		170	24	156	24	144
XCZU2EG		170	24	156	24	144
XCZU3CG		170	24	156	24	144
XCZU3EG		170	24	156	24	144
XAZU1EG		170	24	156	24	144
XAZU2EG		170	24	156	24	144
XAZU3EG		170	24	156	24	144

Table 1-3: Available I/O Pins by Device/Package (Cont'd)

Device	Package	PS I/Os	Total User I/O		Differential I/O	
			HD ⁽¹⁾	HP ⁽¹⁾	HD	HP
XCZU1CG	SFVC784	214	24	156	24	144
XCZU1EG		214	24	156	24	144
XCZU2CG		214	96	156	96	144
XCZU2EG		214	96	156	96	144
XCZU3CG		214	96	156	96	144
XCZU3EG		214	96	156	96	144
XCZU3TCG		214	72	52	72	48
XCZU3TEG		214	72	52	72	48
XCZU4CG		214	96	156	96	144
XCZU4EG		214	96	156	96	144
XCZU4EV		214	96	156	96	144
XCZU5CG		214	96	156	96	144
XCZU5EG		214	96	156	96	144
XCZU5EV		214	96	156	96	144
XAZU1EG		170	24	156	24	144
XAZU2EG		214	96	156	96	144
XAZU3EG		214	96	156	96	144
XAZU4EV		214	96	156	96	144
XAZU5EV		214	96	156	96	144
XQZU3EG		SFRC784	214	96	156	96
XQZU5EV	214		96	156	96	114
XCZU3TCG	SFVD784	214	72	52	72	48
XCZU3TEG		214	72	52	72	48
XCZU4CG	SFVE784	214	72	58	72	52
XCZU4EG		214	72	58	72	52
XCZU4EV		214	72	58	72	52
XCZU5CG		214	72	58	72	52
XCZU5EG		214	72	58	72	52
XCZU5EV		214	72	58	72	52

Table 1-3: Available I/O Pins by Device/Package (Cont'd)

Device	Package	PS I/Os	Total User I/O		Differential I/O	
			HD ⁽¹⁾	HP ⁽¹⁾	HD	HP
XCZU4CG	FBVB900	214	48	156	48	144
XCZU4EG		214	48	156	48	144
XCZU4EV		214	48	156	48	144
XCZU5CG		214	48	156	48	144
XCZU5EG		214	48	156	48	144
XCZU5EV		214	48	156	48	144
XCZU7CG		214	48	156	48	144
XCZU7EG		214	48	156	48	144
XCZU7EV		214	48	156	48	144
XAZU7EV		214	48	156	48	144
XQZU5EV	FFRB900	214	48	156	48	144
XQZU7EV		214	48	156	48	144
XCZU6CG	FFVC900	214	48	156	48	144
XCZU6EG		214	48	156	48	144
XCZU9CG		214	48	156	48	144
XCZU9EG		214	48	156	48	144
XCZU15EG		214	48	156	48	144
XQZU9EG	FFRC900	214	48	156	48	144
XQZU15EG		214	48	156	48	144
XCZU6CG	FFVB1156	214	120	208	120	192
XCZU6EG		214	120	208	120	192
XCZU9CG		214	120	208	120	192
XCZU9EG		214	120	208	120	192
XCZU15EG		214	120	208	120	192
XQZU9EG	FFRB1156	214	120	208	120	192
XQZU15EG		214	120	208	120	192
XCZU7CG	FFVC1156	214	48	312	48	288
XCZU7EG		214	48	312	48	288
XCZU7EV		214	48	312	48	288
XCZU11EG		214	48	312	48	288
XQZU7EV	FFRC1156	214	48	312	48	288
XQZU11EG		214	48	312	48	288
XCZU21DR	FFVD1156	214	72	208	72	192
XQZU21DR	FFRD1156	214	72	208	72	192

Table 1-3: Available I/O Pins by Device/Package (Cont'd)

Device	Package	PS I/Os	Total User I/O		Differential I/O	
			HD ⁽¹⁾	HP ⁽¹⁾	HD	HP
XCZU25DR	FFVE1156	214	48	104	48	96
XCZU27DR		214	48	104	48	96
XCZU28DR		214	48	104	48	96
XCZU42DR		214	24	130	24	120
XCZU43DR		214	48	104	48	96
XCZU47DR		214	48	104	48	96
XCZU48DR		214	48	104	48	96
XCZU63DR		214	24	130	24	120
XCZU64DR		214	24	130	24	120
XCZU65DR		214	24	130	24	120
XCZU67DR		214	24	130	24	120
XQZU28DR	FFRE1156	214	48	104	48	96
XQZU48DR		214	48	104	48	96
XCZU25DR	FSVE1156	214	48	104	48	96
XCZU27DR		214	48	104	48	96
XCZU28DR		214	48	104	48	96
XCZU42DR		214	24	130	24	120
XCZU43DR		214	48	104	48	96
XCZU47DR		214	48	104	48	96
XCZU48DR		214	48	104	48	96
XCZU63DR		214	24	130	24	120
XCZU64DR		214	24	130	24	120
XCZU65DR		214	24	130	24	120
XCZU65DR		214	24	130	24	120
XCZU11EG	FFVB1517	214	72	416	72	384
XCZU17EG		214	72	572	72	528
XCZU19EG		214	72	572	72	528
XQZU19EG	FFRB1517	214	72	572	72	528
XCZU7CG	FFVF1517	214	48	416	48	384
XCZU7EG		214	48	416	48	384
XCZU7EV		214	48	416	48	384
XCZU11EG		214	48	416	48	384
XAZU11EG		214	48	416	48	384

Table 1-3: Available I/O Pins by Device/Package (Cont'd)

Device	Package	PS I/Os	Total User I/O		Differential I/O	
			HD ⁽¹⁾	HP ⁽¹⁾	HD	HP
XCZU25DR	FFVG1517	214	48	299	48	276
XCZU27DR		214	48	299	48	276
XCZU28DR		214	48	299	48	276
XCZU43DR		214	48	299	48	276
XCZU47DR		214	48	299	48	276
XCZU48DR		214	48	299	48	276
XQZU28DR	FFRG1517	214	48	299	48	276
XCZU25DR	FSVG1517	214	48	299	48	276
XCZU27DR		214	48	299	48	276
XCZU28DR		214	48	299	48	276
XCZU43DR		214	48	299	48	276
XCZU47DR		214	48	299	48	276
XCZU48DR		214	48	299	48	276
XQZU48DR	FSRG1517	214	48	299	48	276
XCZU11EG	FFVC1760	214	96	416	96	384
XCZU17EG		214	96	416	96	384
XCZU19EG		214	96	416	96	384
XQZU11EG	FFRC1760	214	96	416	96	384
XQZU19EG		214	96	416	96	384
XCZU17EG	FFVD1760	214	48	260	48	240
XCZU19EG		214	48	260	48	240
XCZU29DR	FFVF1760	214	96	312	96	288
XCZU39DR		214	96	312	96	288
XCZU49DR		214	96	312	96	288
XQZU49DR	FSRF1760	214	96	312	96	288
XCZU46DR	FFVH1760	214	48	312	48	288
XQZU29DR	FFRF1760	214	96	312	96	288
XCZU29DR	FSVF1760	214	96	312	96	288
XCZU39DR		214	96	312	96	288
XCZU46DR	FSVH1760	214	48	312	48	288

Table 1-3: Available I/O Pins by Device/Package (Cont'd)

Device	Package	PS I/Os	Total User I/O		Differential I/O	
			HD ⁽¹⁾	HP ⁽¹⁾	HD	HP
XCZU17EG	FFVE1924	214	96	572	96	528
XCZU19EG		214	96	572	96	528

Notes:

1. The maximum user I/O numbers do not include the GT serial transceiver pins or the PUDC_B and POR_OVERRIDE pins used for configuration.

Pin Definitions

Table 1-4 lists the pin definitions.

Table 1-4: Pin Definitions

Pin Name	Type	Direction	Description
User I/O Pins			
IO_L[1 to 24][P or N]_T[0 to 3] [U or L]_N[0 to 12]_ [multi-function]_[bank number] or IO_T[0 to 3][U or L]_N[0 to 12]_[multi-function]_[bank number]			
	Dedicated	Input/Output	<p>Most user I/O pins are capable of differential signaling and can be implemented as pairs. Each user I/O pin name consists of several indicator labels, where:</p> <ul style="list-style-type: none"> IO indicates a user I/O pin. L[1 to 24] indicates a unique differential pair with P (positive) and N (negative) sides. User I/O pins without the L indicator are single-ended. T[0 to 3][U or L] indicates the assigned byte group and nibble location (upper or lower portion) within that group for the pin. N[0 to 12] the number of the I/O within its byte group. [multi-function] indicates any other functions that the pin can provide. If not used for this function, the pin can be a user I/O. [bank number] indicates the assigned bank for the user I/O pin.
User I/O Multi-Function Pins			
GC or HDGC	Multi-function	Input	<p>Four global clock (GC or HDGC) pin pairs are in each bank. HDGC pins have direct access to the global clock buffers. GC pins have direct access to the global clock buffers and the MMCMs and PLLs that are in the clock management tile (CMT) adjacent to the same I/O bank. GC and HDGC inputs provide dedicated, high-speed access to the internal global and regional clock resources. GC and HDGC inputs use dedicated routing and must be used for clock inputs where the timing of various clocking features is imperative.</p> <p>Up-to-date information about designing with the GC (or HDGC) pin is available in the <i>UltraScale Architecture Clocking Resources User Guide (UG572)</i>.</p>
VRP ⁽¹⁾	Multi-function	N/A	<p>This pin is for the DCI voltage reference resistor of P transistor (per bank, to be pulled Low with a reference resistor).</p>

Table 1-4: Pin Definitions (Cont'd)

Pin Name	Type	Direction	Description
DBC QBC	Multi-function	Input	Byte lane clock (DBC and QBC) input pin pairs are clock inputs directly driving source synchronous clocks to the bit slices in the I/O banks. In memory applications, these are also known as DQS. For more information, consult the <i>UltraScale Architecture SelectIO Resources User Guide (UG571)</i> .
PERSTN[0 to 1]	Multi-function	Input	Default reset pin locations for the integrated block for PCI Express.
Configuration Pins			
For more information on configuration and recommended external pull-up/pull-down resistors, see the <i>Zynq UltraScale+ Device Technical Reference Manual (UG1085)</i> and the <i>UltraScale Architecture PCB Design Guide (UG583)</i> .			
PUDC_B	Dedicated	Input	Active-Low input enables internal pull-ups during configuration on all SelectIO pins: 0 = Weak preconfiguration I/O pull-up resistors enabled. 1 = Weak preconfiguration I/O pull-up resistors disabled. PUDC_B is powered by V_{CCAUX} .
POR_OVERRIDE	Dedicated	Input	Power-on reset delay override. 0 = Standard PL power-on delay time (recommended default). 1 = Faster PL power-on delay time. CAUTION! Do not allow this pin to float before and during configuration. This pin must be tied to V_{CCINT} or GND.
PS_DONE	Dedicated	Output	PS DONE signal. Requires an external pull-up resistor.
PS_ERROR_OUT	Dedicated	Output	PS error indication.
PS_ERROR_STATUS	Dedicated	Output	PS error status.
PS_INIT_B	Dedicated	Input/Output	Initialization completion indicator after POR. High voltage indicates completion of initialization (PL). Requires an external pull-up resistor.
PS_JTAG_TCK	Dedicated	Input	JTAG data clock.
PS_JTAG_TDI	Dedicated	Input	JTAG data input.
PS_JTAG_TDO	Dedicated	Output	JTAG data output.
PS_JTAG_TMS	Dedicated	Input	JTAG mode select.
PS_MODE	Dedicated	Input/Output	PS MIO mode selection pins.
PS_PADI	Dedicated	Input	Crystal pad input. Real-time clock (RTC).
PS_PADO	Dedicated	Output	Crystal pad output. Real-time clock (RTC).

Table 1-4: Pin Definitions (Cont'd)

Pin Name	Type	Direction	Description
PS_POR_B	Dedicated	Input	Power on reset. PS_POR_B must be held at 0 until all PS power supplies meet voltage requirements and the PS_CLK reference is within specification. When deasserted the PS begins the boot process.
PS_PROG_B	Dedicated	Input	PROG_B signal to reset configuration block. Requires an external pull-up resistor.
PS_REF_CLK	Dedicated	Input	System reference clock. PS_CLK must be between 27 MHz and 60 MHz.
PS_SRST_B	Dedicated	Input	System reset. For use when debugging. When 0, forces the PS to enter the system reset sequence.
Power/Ground Pins			
For more information on voltage specifications see the <i>Zynq UltraScale+ MPSoC Data Sheet: DC and AC Switching Characteristics (DS925)</i> or the <i>Zynq UltraScale+ RFSoc Data Sheet: DC and AC Switching Characteristics (DS926)</i> .			
GND	Dedicated	N/A	Ground.
RSVDGND	Dedicated	N/A	Reserved pins that must be tied to GND. Note: These pins are labeled differently depending upon the device. They can serve a different purpose between footprint compatible devices. To migrate to a footprint compatible device, account for any variation in pin functionality.
RSVD	Dedicated	N/A	Reserved pin. Leave floating.
VCCINT	Dedicated	N/A	Power-supply pins for the PL internal logic.
VCCINT_IO	Dedicated	N/A	Power-supply pins for the I/O banks. VCCINT_IO must be connected to VCCBRAM on the board.
VCCINT_VCU	Dedicated	N/A	Power-supply pins for the video codec unit (EV devices only). Note: If the video codec unit is not used, then connect the VCCINT_VCU pins to GND to reduce power. In the CG and EG devices, the EV device VCCINT_VCU pins appear as RSVDGND pins. Note: When migrating from an EV device to a CG or EG device in the same package, AMD recommends connecting the VCCINT_VCU pins to GND to reduce power. Further VCCINT_VCU migration guidelines are available in <i>UltraScale Architecture PCB Design Guide (UG583)</i> .  IMPORTANT: V_{CCINT_VCU} requires its own dedicated power supply. Do not combine with other power rails on the PCB.
VCCAUX	Dedicated	N/A	Power-supply pins for auxiliary circuits.

Table 1-4: Pin Definitions (Cont'd)

Pin Name	Type	Direction	Description
VCCAUX_IO	Dedicated	N/A	Auxiliary power-supply pins for the I/O banks. VCCAUX_IO must be connected to VCCAUX on the board. Note: Package files for XQ ruggedized devices (for example: FFRC784) have unique pin names for VCCAUX_HPIO and VCCAUX_HDIO. These pins can be connected to a common VCCAUX_IO supply.
VCCBRAM	Dedicated	N/A	Power-supply pins for PL block RAM logic.
VCCO_[bank number] ⁽²⁾	Dedicated	N/A	Power-supply pins for the output drivers (per bank).
VREF_[bank number]	Dedicated	N/A	Voltage reference for input pins (per bank).
VCCADC	Dedicated	N/A	System Monitor analog supply voltage.
GNDADC	Dedicated	N/A	System Monitor analog ground.
VCC_PSADC	Dedicated	N/A	PS ADC supply voltage.
GND_PSADC	Dedicated	N/A	PS ADC analog ground.
VCC_PSAUX	Dedicated	N/A	PS auxiliary circuits supply voltage.
VCC_PSBATT	Dedicated	N/A	PS RTC battery supply voltage. When not used, tie to GND.
VCC_PSDDR_PLL	Dedicated	N/A	PS DDR PLL supply voltage.
VCC_PSPLL	Dedicated	N/A	PS PLL (DPLL, RPLL, APLL, VPLL, IOPLL) supply voltage.
VCC_PSINTFP	Dedicated	N/A	PS full-power domain supply voltage.
VCC_PSINTFP_DDR	Dedicated	N/A	PS DDR full-power domain supply voltage.
VCC_PSINTLP	Dedicated	N/A	PS low-power domain supply voltage.
VCCO_PSI0[0:3]_[500:503]	Dedicated	N/A	PS I/O supply voltage.
VCCO_PSDDR	Dedicated	N/A	PS DDR controller I/O supply voltage.
PS MIO Pins			
PS_MIO	Multi-function	Input/Output	Multiplexed I/O can be configured to support multiple I/O interfaces. These interfaces include SPI and Quad-SPI flash, NAND, USB, Ethernet, SDIO, UART, SPI, and GPIO interfaces.
PS DDR Pins			
PS_DDR_DQ	Dedicated	Input/Output	DRAM data.
PS_DDR_DQS_P	Dedicated	Input/Output	DRAM differential data strobe positive.
PS_DDR_DQS_N	Dedicated	Input/Output	DRAM differential data strobe negative.
PS_DDR_ALERT_N	Dedicated	Input	DRAM alert signal.
PS_DDR_ACT_N	Dedicated	Output	DRAM activation command.

Table 1-4: Pin Definitions (Cont'd)



Pin Name	Type	Direction	Description
PS_DDR_A	Dedicated	Output	DRAM row and column address.
PS_DDR_BA	Dedicated	Output	DRAM bank address.
PS_DDR_BG	Dedicated	Output	DRAM bank group.
PS_DDR_CK_N	Dedicated	Output	DRAM differential clock negative.
PS_DDR_CK	Dedicated	Output	DRAM differential clock positive.
PS_DDR_CKE	Dedicated	Output	DRAM clock enable.
PS_DDR_CS	Dedicated	Output	DRAM chip select.
PS_DDR_DM	Dedicated	Output	DRAM data mask.
PS_DDR_ODT	Dedicated	Output	DRAM termination control.
PS_DDR_PARITY	Dedicated	Output	DRAM parity signal
PS_DDR_RAM_RST_N	Dedicated	Output	DRAM reset signal, active low.
PS_DDR_ZQ	Dedicated	Input/Output	ZQ calibration signal.
System Monitor Pins⁽³⁾			
AD[0 to 15][P or N]	Multi-function	Input	System Monitor differential auxiliary analog inputs 0–15.
VREFP	Dedicated	N/A	Voltage reference input.
VREFN	Dedicated	N/A	Voltage reference GND.
VP	Dedicated	Input	System Monitor dedicated differential analog input (positive side).
VN	Dedicated	Input	System Monitor dedicated differential analog input (negative side).
I2C_SCLK	Multi-function	Bidirectional	I2C serial clock. Directly connected to the System Monitor DRP interface for I2C operation configuration.  <hr/> IMPORTANT: Because the SYSMON I2C interface is active after power-on, this pin should only be used for I2C access until after configuration.
I2C_SDA	Multi-function	Bidirectional	I2C serial data line. Directly connected to the System Monitor DRP interface for I2C operation configuration.  <hr/> IMPORTANT: Because the SYSMON I2C interface is active after power-on, this pin should only be used for I2C access until after configuration.

Table 1-4: Pin Definitions (Cont'd)

Pin Name	Type	Direction	Description
SMBALERT	Multi-function	Bidirectional	Optional PMBus alert, interrupt signal. When Low, indicates a system fault that must be cleared using PMBus commands. Connect to SMBALERT_TS. For more information, see the <i>UltraScale Architecture System Monitor User Guide (UG580)</i> .  IMPORTANT: By default, the PMBus is active prior to configuration. Only use as a multi-functional I/O pin in designs that can tolerate this pin being driven prior to configuration. <hr/> This pin is present on Kintex UltraScale+ and Virtex UltraScale+ devices.
Multi-gigabit Serial Transceiver Pins (GTHE4, GTYE4, and PS-GTR)			
For more information on the GTH and GTY transceivers, see the <i>UltraScale Architecture GTH Transceiver User Guide (UG576)</i> or <i>UltraScale Architecture GTY Transceiver User Guide (UG578)</i> . For more information on the PS-GTR transceivers, see the <i>Zynq UltraScale+ Device Technical Reference Manual (UG1085)</i> .			
MGTHRXP[P or N][0 to 3]_ _ [GT quad number]	Dedicated	Input	RXP and RXN are the differential input pairs for each of the receivers in the GTH Quad.
MGHTXP[P or N][0 to 3]_ _ [GT quad number]	Dedicated	Output	TXP and TXN are the differential output pairs for each of the transmitters in the GTH Quad.
MGTYRX[P or N][0 to 3]_ _ [GT quad number]	Dedicated	Input	RXP and RXN are the differential input pairs for each of the receivers in the GTY Quad.
MGTYPXP[P or N][0 to 3]_ _ [GT quad number]	Dedicated	Output	TXP and TXN are the differential output pairs for each of the transmitters in the GTY Quad.
PS_MGTRRX[P or N][0 to 3]_ _ [GT quad number]	Dedicated	Input	RXP and RXN are the differential input pairs for each of the receivers in the PS-GTR Quad.
PS_MGTRXP[P or N][0 to 3]_ _ [GT quad number]	Dedicated	Output	TXP and TXN are the differential output pairs for each of the transmitters in the PS-GTR Quad.
MGTAVCC_[L or R] [N or S] ⁽⁴⁾	Dedicated	Input	Analog power-supply pin for the receiver and transmitter internal circuits for the GTH or GTY transceivers.
PS_MGTRAVCC	Dedicated	N/A	Analog power-supply pin for the receiver and transmitter internal circuits for the PS-GTR transceivers.
MGTAVTT_[L or R] [N or S] ⁽⁴⁾	Dedicated	Input	Analog power-supply pin for the transmitter and receiver termination circuits for the GTH or GTY transceivers.
MGTVCCAUX_[L or R] [N or S] ⁽⁴⁾	Dedicated	Input	Auxiliary analog Quad PLL (QPLL) voltage supply for the transceivers.

Table 1-4: Pin Definitions (Cont'd)

Pin Name	Type	Direction	Description
PS_MGTRAVTT	Dedicated	N/A	Analog power-supply pin for the transmitter and receiver termination circuits for the PS-GTR transceivers.
MGTREFCLK[0 or 1] [P or N]	Dedicated	Input/Output	Configured as either reference clock input pins or as RX recovered clock output pins for the GTH or GTY transceivers.
PS_MGTREFCLK[0 to 3] [P or N]	Dedicated	Input	Differential reference clock for the PS-GTR transceivers.
MGTAVTTRCAL_[L or R] [N or S] ⁽⁴⁾	Dedicated	N/A	Bias current supply for the termination resistor calibration circuit.
MGTRREF_[L or R] [N or S] ⁽⁴⁾	Dedicated	Input	Calibration resistor pin for the termination resistor calibration circuit for the GTH or GTY transceivers.
PS_MGTRREF	Dedicated	Input	Calibration resistor pin for the termination resistor calibration circuit for the PS-GTR transceivers.
Zynq UltraScale+ RFSoc Dedicated Pins			
VCCSDFEC	Dedicated	N/A	Power supply for the FEC blocks.
VCCINT_AMS	Dedicated	N/A	Digital power supply for the DDC.
ADC_AVCC	Dedicated	N/A	Core ADC and PLL power supply.
ADC_AVCCAUX	Dedicated	N/A	Input buffer and PLL power supply.
ADC_GND	Dedicated	N/A	Analog ground for the ADC.
ADC_SUB_GND	Dedicated	N/A	Digital ground for the ADC.
ADC_CLK_[P or N]	Dedicated	Input	External reference clock for PLL or ADC direct sampling clock input.
VCM01/VCM23	Dedicated	N/A	ADC common mode voltage.
ADC_VIN_[0 to 3 or _I01 and _I23]_[P or N]	Dedicated	Input	Analog input signal to the ADC.
ADC_REXT	Dedicated	N/A	ADC external resistor.
DAC_AVCC	Dedicated	N/A	Core DAC and PLL power supply.
DAC_AVCCAUX	Dedicated	N/A	DAC and PLL power supply.
DAC_AVTT	Dedicated	N/A	Termination voltage for on-die 50Ω termination resistors.
DAC_GND	Dedicated	N/A	Analog ground for the DAC.
DAC_SUB_GND	Dedicated	N/A	Digital ground for the DAC.
DAC_CLK_[P or N]	Dedicated	Input	External reference clock for PLL or DAC direct sampling clock input.
SYSREF_[P or N]	Dedicated	Input	External reference clock/trigger for synchronizing timing of the data converters.
DAC_VOUT[0 to 3]_[P or N]	Dedicated	Output	Analog output signals from the DAC.
DAC_REXT	Dedicated	Input	DAC external resistor.

Table 1-4: Pin Definitions (Cont'd)

Pin Name	Type	Direction	Description
Other Dedicated Pins			
DXN	Dedicated	N/A	Temperature-sensing diode pins (Anode: DXP; Cathode: DXN). The thermal diode is accessed by using the DXP and DXN pins. When not used, tie to GND.
DXP			To use the thermal diode an appropriate external thermal monitoring IC must be added. Consult the external thermal monitoring IC data sheet for usage guidelines.

Notes:

1. See the DCI sections in *UltraScale Architecture SelectIO Resources User Guide (UG571)* for more information on the VRP pins.
2. V_{CC0} pins in unbonded banks must be connected to the V_{CC0} for that bank (for package migration). Do NOT connect unbonded V_{CC0} pins to different supplies. Without a package migration requirement, V_{CC0} pins in unbonded banks can be tied to a common supply (V_{CC0} or GND).
3. See the *UltraScale Architecture System Monitor User Guide (UG580)* for the default connections required to support on-chip monitoring.
4. L (left), R (right), N (north), and S (south) signify the GT transceiver quad power supply groups.

Footprint Compatibility between Packages

Zynq UltraScale+ devices are footprint compatible only with other Zynq UltraScale+ devices with the same number of package pins and the same preceding alphabetic designator. For example, XCZU9EG-FFVB1156 is compatible with the XCZU15EG-FFVB1156, but not with the XCZU9EG-FFVC900. Pins that are available in one device but are not available in another device are labeled as *No Connects* in the other device's package file.



IMPORTANT: Footprint compatibility does not necessarily imply that all pins will function in the same manner for different devices in a package. For limitations and guidelines on designing for footprint compatible packages, refer to the *Migration Between the Zynq UltraScale+ Devices and Packages* section of *UltraScale Architecture PCB Design Guide (UG583)*.

Table 1-5 shows the footprint compatible devices available for each package. See the *Zynq UltraScale+ MPSoC Overview (DS891)* for specific package letter code options. All non-InFO packages are available with eutectic BGA balls. For these packages, the device type is XQ and the Pb-free signifier in the package name is a Q.

Table 1-5: Footprint Compatibility

Packages	Footprint Compatible Devices					
SBVA484 SFRA484	XCZU1CG, XCZU1EG, XAZU1EG	XCZU2CG, XCZU2EG, XAZU2EG	XCZU3CG, XCZU3EG, XAZU3EG, XQZU3EG			
UBVA494	XCZU1CG, XCZU1EG					
UBVA530	XCZU2CG, XCZU2EG,	XCZU3CG, XCZU3EG,				
SFVA625	XCZU1CG, XCZU1EG, XAZU1EG	XCZU2CG, XCZU2EG, XAZU2EG	XCZU3CG, XCZU3EG, XAZU3EG			
SFVC784 SFRC784	XCZU1CG, XCZU1EG, XAZU1EG	XCZU2CG, XCZU2EG, XAZU2EG	XCZU3CG, XCZU3EG, XAZU3EG, XQZU3EG	XCZU3TCG, XCZU3TEG	XCZU4CG, XCZU4EG, XCZU4EV, XAZU4EV	XCZU5CG, XCZU5EG, XCZU5EV, XAZU5EV, XQZU5EV
SFVD784 ⁽³⁾	XCZU3TCG, XCZU3TEG					
SFVE784 ⁽³⁾	XCZU4CG, XCZU4EG, XCZU4EV	XCZU5CG, XCZU5EG, XCZU5EV				

Table 1-5: Footprint Compatibility (Cont'd)

Packages	Footprint Compatible Devices					
FBVB900 FFRB900	XCZU4CG, XCZU4EG, XCZU4EV	XCZU5CG, XCZU5EG, XCZU5EV, XQZU5EV	XCZU7CG, XCZU7EG, XCZU7EV, XAZU7EV, XQZU7EV			
FFVC900 FFRC900	XCZU6CG, XCZU6EG	XCZU9CG, XCZU9EG, XQZU9EG	XCZU15EG, XQZU15EG			
FFVB1156 FFRB1156	XCZU6CG, XCZU6EG	XCZU9CG, XCZU9EG, XQZU9EG	XCZU15EG, XQZU15EG			
FFVC1156 FFRC1156	XCZU7CG, XCZU7EG, XCZU7EV, XQZU7EV	XCZU11EG, XQZU11EG				
FFVD1156	XCZU21DR, XQZU21DR					
FFVE1156 FSVE1156 FFRE1156	XCZU25DR	XCZU27DR, XCZU43DR ⁽¹⁾ , XCZU47DR ⁽¹⁾ , XCZU48DR ⁽¹⁾ , XQZU48DR ⁽¹⁾	XCZU42DR ⁽¹⁾⁽²⁾ , XCZU63DR ⁽¹⁾⁽²⁾ , XCZU64DR ⁽¹⁾⁽²⁾ , XCZU65DR ⁽¹⁾⁽²⁾ , XCZU67DR ⁽¹⁾⁽²⁾		XCZU28DR, XQZU28DR	
FFVB1517	XCZU11EG	XCZU17EG	XCZU19EG, XQZU19EG			
FFVF1517	XCZU7CG, XCZU7EG, XCZU7EV	XCZU11EG, XAZU11EG				
FFVG1517 FSVG1517 FSRG1517	XCZU25DR	XCZU27DR, XCZU43DR ⁽¹⁾ , XCZU47DR ⁽¹⁾ , XCZU49DR ⁽¹⁾	XCZU28DR, XQZU28DR		XCZU48DR ⁽¹⁾ , XQZU48DR ⁽¹⁾	
FFVC1760 FFRC1760	XCZU11EG, XQZU11EG	XCZU17EG	XCZU19EG, XQZU19EG			
FFVD1760	XCZU17EG	XCZU19EG				
FFVF1760 FSVF1760 FFRF1760 FSRF1760	XCZU29DR, XCZU39DR, XCZU49DR ⁽¹⁾ XQZU29DR, XQZU49DR ⁽¹⁾					
FFVH1760	XCZU46DR					
FSVH1760	XCZU46DR					

Table 1-5: Footprint Compatibility (Cont'd)

Packages	Footprint Compatible Devices					
FBVB900 FFRB900	XCZU4CG, XCZU4EG, XCZU4EV	XCZU5CG, XCZU5EG, XCZU5EV, XQZU5EV	XCZU7CG, XCZU7EG, XCZU7EV, XAZU7EV, XQZU7EV			
FFVC900 FFRC900	XCZU6CG, XCZU6EG	XCZU9CG, XCZU9EG, XQZU9EG	XCZU15EG, XQZU15EG			
FFVB1156 FFRB1156	XCZU6CG, XCZU6EG	XCZU9CG, XCZU9EG, XQZU9EG	XCZU15EG, XQZU15EG			
FFVC1156 FFRC1156	XCZU7CG, XCZU7EG, XCZU7EV, XQZU7EV	XCZU11EG, XQZU11EG				
FFVD1156	XCZU21DR, XQZU21DR					
FFVE1156 FSVE1156 FFRE1156	XCZU25DR	XCZU27DR, XCZU43DR ⁽¹⁾ , XCZU47DR ⁽¹⁾ , XCZU48DR ⁽¹⁾ , XQZU48DR ⁽¹⁾	XCZU42DR ⁽¹⁾⁽²⁾ , XCZU63DR ⁽¹⁾⁽²⁾ , XCZU64DR ⁽¹⁾⁽²⁾ , XCZU65DR ⁽¹⁾⁽²⁾ , XCZU67DR ⁽¹⁾⁽²⁾		XCZU28DR, XQZU28DR	
FFVB1517	XCZU11EG	XCZU17EG	XCZU19EG, XQZU19EG			
FFVF1517	XCZU7CG, XCZU7EG, XCZU7EV	XCZU11EG, XAZU11EG				
FFVG1517 FSVG1517 FSRG1517	XCZU25DR	XCZU27DR, XCZU43DR ⁽¹⁾ , XCZU47DR ⁽¹⁾ , XCZU49DR ⁽¹⁾	XCZU28DR, XQZU28DR		XCZU48DR ⁽¹⁾ , XQZU48DR ⁽¹⁾	
FFVC1760 FFRC1760	XCZU11EG, XQZU11EG	XCZU17EG	XCZU19EG, XQZU19EG			
FFVD1760	XCZU17EG	XCZU19EG				
FFVF1760 FSVF1760 FFRF1760 FSRF1760	XCZU29DR, XCZU39DR, XCZU49DR ⁽¹⁾ XQZU29DR, XQZU49DR ⁽¹⁾					
FFVH1760	XCZU46DR					
FSVH1760	XCZU46DR					

Table 1-5: Footprint Compatibility (Cont'd)

Packages	Footprint Compatible Devices		
FFVE1924	XCZU17EG	XCZU19EG	

Notes:

1. The ZU4xDR and ZU6xDR devices are footprint compatible devices. However, they have a different set of ADC and DAC power sequencing requirements from the ZU2xDR devices. Refer to [Zynq UltraScale+ RFSoc Data Sheet: DC and AC Switching Characteristics \(DS926\)](#) for specific power sequencing differences.
2. The XCZU42DR, XCZU63DR, XCZU64DR, XCZU65DR, and XCZU67DR are only partially compatible with other devices in the FFVE1156 and FSVE1156 packages due to key differences in the ADC and DAC architecture. When planning migration between devices, differences that must be addressed include ADC and DAC bank/pin locations and power rail voltage specifications.
3. Migration between the SFVD784 and SFVE784 is possible by following the guidelines in the [Migration Between SFVD784 and SFVE784 Packages](#) section.

Many Zynq UltraScale+ devices that are footprint compatible in a package have different I/O bank and transceiver quad numbers connected to the same package pins. Due to these differences, when migrating between devices in a specific package, the type of bank (HD vs. HP) or quad (PS-GTR, GTH, or GTY), whether a bank is connected or NC at the package pins, and where the bank or quad is located on the die must be taken into consideration. [Table 1-7](#) and [Table 1-8](#) show how the banks and transceiver quads are numbered between devices in each package.

For all grouped-together footprint-compatible packages, the bank and quad numbers in the same column (indicated by the letters A through Z) for each device are connected to the same package pins. For example, in the FFVB1517 packages, bank 88 for the XCZU11 is connected to the same pins as bank 90 for the XCZU17 and XCZU19.

A limited number of HP I/O banks have fewer than 52 SelectIO pins. For a visual representation of all of this information, see the [Die Level Bank Numbering Overview](#) section.

Migration Between SFVD784 and SFVE784 Packages

The SFVD784 and SFVE784 packages support footprint compatibility provided the following differences are addressed during the design process:

- The transition between seven GND pins in the SFVD784 and six HP I/O pins plus one VREF pin from Bank 66 in the SFVE784. Pins M6, M8, L9, L11, L13, L15, and J15 as shown in the following figure.

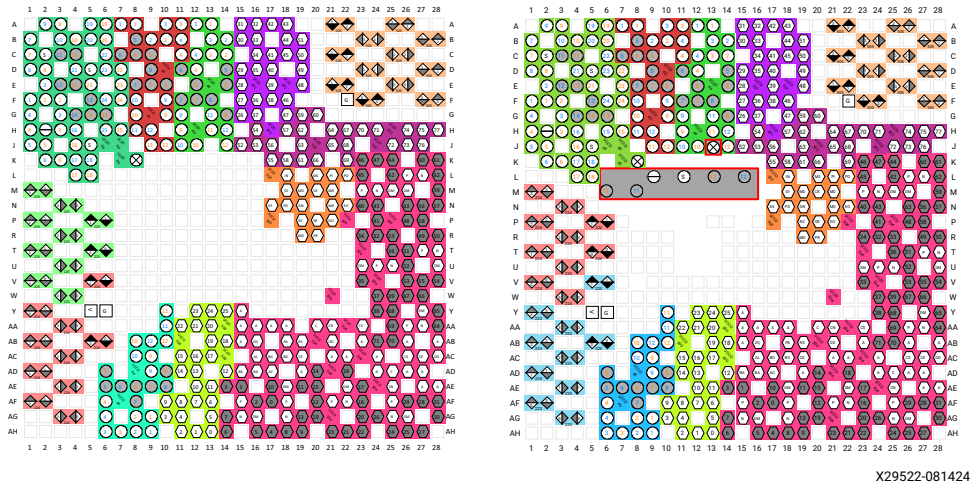

Figure 1-1: SFVD784 I/O Pin Map (Left) vs. SFVE784 I/O Pin Map (Right)

- The transition between four VCCINT pins in the SFVD784 and four VCCINT_VCU pins for EV devices, or RSVDGND pins for CG and EG devices in the SFVE784. Pins W14, R16, U16, and W16 as shown in the following figure.

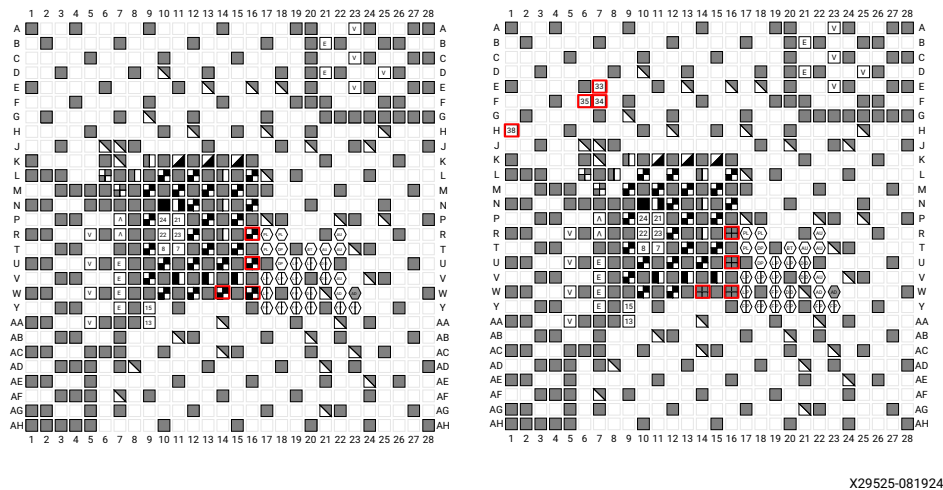

Figure 1-2: SFVD784 Configuration and Power Pin Map (Left) vs. SFVE784 Configuration and Power Pin Map (Right)

- The differences between the System Monitor analog input pin assignments in bank 44 for the SFVD784.
- For example: AD8N on pin AB9 for SFVD784 vs. AD0N on pin AB9 for SFVE784.
- Refer to the [ASCII Pinout Files](#) for a full list of analog input pin assignments.
- The addition of PERSTN0, PERSTN1_I2C_SDA, I2C_SCLK, and SMBALERT functionality on pins F6, F7, and H1 for SFVE784.

See the *I/O Bank Migration* and *Transceiver Quad Migration* sections for differences in bank numbering for migrated devices. The following table lists the changed pin functions between migrated devices.

Table 1-6: Pin Functionality Differences Between SFVD784 and SFVE784 Packages

Pin	ZU3T SFVD784 Pin Name	ZU4CG, ZU4EG, ZU5CG, ZU5EG SFVE784 Pin Names	ZU4EV, ZU5EV SFVE784 Pin Name
J13	GND	VREF_66	VREF_66
L11	GND	IO_T3U_N12_66	IO_T3U_N12_66
L13	GND	IO_L12P_T1U_N10_GC_66	IO_L12P_T1U_N10_GC_66
L15	GND	IO_L12N_T1U_N11_GC_66	IO_L12N_T1U_N11_GC_66
L9	GND	IO_T0U_N12_VRP_66	IO_T0U_N12_VRP_66
M6	GND	IO_L11P_T1U_N8_GC_66	IO_L11P_T1U_N8_GC_66
M8	GND	IO_L11N_T1U_N9_GC_66	IO_L11N_T1U_N9_GC_66
R16	VCCINT	RSVDGND	VCCINT_VCU
U16	VCCINT	RSVDGND	VCCINT_VCU
W14	VCCINT	RSVDGND	VCCINT_VCU
W16	VCCINT	RSVDGND	VCCINT_VCU
E7	IO_L23P_T3U_N8_66		IO_L23P_T3U_N8_I2C_SCLK_65
F6	IO_L24N_T3U_N11_66		IO_L24N_T3U_N11_PERSTN0_65
F7	IO_L24P_T3U_N10_66		IO_L24P_T3U_N10_PERSTN1_I2C_SDA_65
H1	IO_L4P_T0U_N6_DBC_AD7P_66		IO_L4P_T0U_N6_DBC_AD7P_SMBALERT_65

I/O Bank Migration

For differences in bank numbering, refer to [Table 1-7](#) and [Table 1-8](#). All other general migration guidelines and *UltraScale Architecture PCB Design Guide (UG583)* apply to the SFVD784 and SFVE784 as well.

Table 1-7: I/O Bank Migration (HD Banks are Shaded)

Package	Device	Package to Device I/O Mapping ⁽¹⁾																Un										
		A	B	C	D	E	F	G	H	I	J	K	L	M	N	O	P		Q	R	S	T	U	V	W	X	Y	Z
SBVA484	XCZU1	44	65	66																							64	
	XAZU1																											
	XCZU2	26	65	66 ⁽²⁾																							25, 24, 44,	
	XAZU2																										25, 24, 44,	
SFRA484	XCZU3	26	65	66 ⁽²⁾																						25, 24, 44,		
	XAZU3	26	65	66 ⁽²⁾																						25, 24, 44,		
UBVA494	XCZU1	44	65	66																						64		
UBVA530	XCZU2	26	65	66 ⁽²⁾																						25, 24, 44,		
	XCZU3	26	65	66 ⁽²⁾																						25, 24, 44,		
SFVA625	XCZU1	64	65	66	44																					25, 24, 44,		
	XAZU1																											
	XCZU2	64	65	66	26																					25, 24, 44		
	XAZU2																											
SFVA625	XCZU3	64	65	66	26																					25, 24, 44		
	XAZU3																											

Table 1-7: I/O Bank Migration (HD Banks are Shaded) (Cont'd)

Package	Device	Package to Device I/O Mapping ⁽¹⁾																										Un																				
		A	B	C	D	E	F	G	H	I	J	K	L	M	N	O	P	Q	R	S	T	U	V	W	X	Y	Z																					
SFVC784	XCZU1	64	65	66																									44																			
	XAZU1																																															
	XCZU2	64	65	66	25	26										24	44																															
	XAZU2																																															
	XCZU3	64	65	66	25	26										24	44																															
XAZU3																																																
XCZU3T				66	45	46									44																																	
XCZU4	64	65	66	66	45	46									44	43																																
XAZU4																																																
XCZU5	64	65	66	66	45	46									44	43																																
XAZU5																																																
XQZU3	64	65	66	66	25	26									24	44																																
XQZU5	64	65	66	66	45	46									44	43																																
XCZU3T				66	45	46									44																																	
XCZU4				66	65 ⁽²⁾	45	46								43																																	
XCZU5				66	65 ⁽²⁾	45	46								43																																	
FBVB900	XCZU4	64	65	66												46	45																															
	XCZU5	64	65	66												46	45																															
	XCZU7	64	65	66												47	48																															
	XAZU7	64	65	66												47	48																															
FFRB900	XQZU5	64	65	66											46	45																																
	XQZU7	64	65	66											47	48																																

Table 1-7: I/O Bank Migration (HD Banks are Shaded) (Cont'd)

Package	Device	Package to Device I/O Mapping ⁽¹⁾																										Un	
		A	B	C	D	E	F	G	H	I	J	K	L	M	N	O	P	Q	R	S	T	U	V	W	X	Y	Z		
FFVC900	XCZU6		64	65	66											48	47												50, 49, 44,
	XCZU9		64	65	66											48	47												50, 49, 44,
	XCZU15		64	65	66											48	47												50, 49, 44,
FFRC900	XQZU9		64	65	66											48	47												50, 49, 44,
	XQZU15		64	65	66											48	47												50, 49, 44,
FFVB1156	XCZU6	44	64	65	66	67										47	48	49	50										
	XCZU9	44	64	65	66	67										47	48	49	50										
	XCZU15	44	64	65	66	67										47	48	49	50										
FFRB1156	XQZU9	44	64	65	66	67										47	48	49	50										
	XQZU15	44	64	65	66	67										47	48	49	50										
FFVC1156	XCZU7		64	65	66											87	88	68	67	28									27, 48, 47,
	XCZU11		64	65	66											88	89	69	68	67									71, 70, 91,
	XQZU7		64	65	66											87	88	68	67	28									27, 48, 47,
	XQZU11		64	65	66											88	89	69	68	67									71, 70, 91,
FFVD1156	XCZU21		65	66	67	68										87	88	89											71, 70, 69,
FFRD1156	XQZU21		65	66	67	68										87	88	89											71, 70, 69,

Table 1-7: I/O Bank Migration (HD Banks are Shaded) (Cont'd)

Package	Device	Package to Device I/O Mapping ⁽¹⁾																										Un
		A	B	C	D	E	F	G	H	I	J	K	L	M	N	O	P	Q	R	S	T	U	V	W	X	Y	Z	
FFVE1156 FSVE1156	XCZU25			65	66										88	89												69, 68, 67,
	XCZU27			65	66										88	89												71, 70, 69,
	XCZU28			65	66										88	89												71, 70, 69,
	XCZU42			65	66									67 ⁽²⁾	88													68, 64
	XCZU43			65	66										88	89												71, 70, 69
	XCZU47			65	66										88	89												71, 70, 69,
	XCZU48			65	66										88	89												71, 70, 69,
	XCZU63			65	66										67 ⁽²⁾	88												68, 64
FFRE1156	XCZU64			65	66									67 ⁽²⁾	88												68, 64	
	XCZU65			65	66									67 ⁽²⁾	88												68, 64	
	XCZU67			65	66									67 ⁽²⁾	88												68, 64	
	XQZU28			65	66										88	89												71, 70, 69,
FFVB1517	XQZU48			65	66									88	89												71, 70, 69,	
	XCZU11			65	64	66									88	89	90					71	70	69	68	67	91	
	XCZU17			65	64	66									90	91	93	74	73	72	71	70	69	68	67		94	
	XCZU19			65	64	66									90	91	93	74	73	72	71	70	69	68	67		94	
	XQZU19			65	64	66									90	91	93	74	73	72	71	70	69	68	67		94	
FFVF1517	XCZU7			65	66	64	63								87	88	67	68	28	27							48, 47	
	XCZU11			65	66	67	64								88	89	70	71	69	68							91, 90	
	XAZU11			65	66	67	64								88	89	70	71	69	68							91, 90	

Table 1-7: I/O Bank Migration (HD Banks are Shaded) (Cont'd)

Package	Device	Package to Device I/O Mapping ⁽¹⁾																										Un
		A	B	C	D	E	F	G	H	I	J	K	L	M	N	O	P	Q	R	S	T	U	V	W	X	Y	Z	
FFVG1517	XCZU25	84	64	65	66										87				67	68	69							89, 88
	XCZU27	84	64	65	66										87				67	68	69							71, 70, 91,
	XCZU28	84	64	65	66										87				67	68	69							71, 70, 91,
	XCZU43	84	64	65	66										87				67	68	69							71, 70, 91,
FSVG1517	XCZU47	84	64	65	66										87				67	68	69							71, 70, 91,
	XCZU48	84	64	65	66										87				67	68	69							71, 70, 91,
FFRG1517	XQZU28	84	64	65	66										87				67	68	69							71, 70, 91,
FSRG1517	XQZU48	84	64	65	66										87				67	68	69							71, 70, 91,
FFVC1760	XCZU11			65	64	66	67								88	89	90	91	71	70	69	68						
	XCZU17			65	64	66	67								90	91	93	94	71	70	69	68						74, 73, 72
	XCZU19			65	64	66	67								90	91	93	94	71	70	69	68						74, 73, 72
	XQZU11			65	64	66	67								88	89	90	91	71	70	69	68						
FFRC1760	XQZU19			65	64	66	67								90	91	93	94	71	70	69	68						74, 73, 72
	XCZU17			65	66										90	91	71	70	69									74, 73, 72,
FFVD1760	XCZU19			65	66										90	91	71	70	69									74, 73, 72,
FFVF1760	XCZU29	84	64	65	66										87	88	89		67	68	69							71, 70, 91,
	XCZU39	84	64	65	66										87	88	89		67	68	69							71, 70, 91,
	XCZU49 ⁽¹⁾	84	64	65	66										87	88	89		67	68	69							71, 70, 91,
	XQZU29	84	64	65	66										87	88	89		67	68	69							71, 70, 91,
FSRF1760	XQZU49	84	64	65	66									87	88	89		67	68	69							71, 70, 91,	
FFVH1760	XCZU46			64	65	66												90	91		69	71	70				67, 68, 84,	
FSVH1760																												

Table 1-7: I/O Bank Migration (HD Banks are Shaded) (Cont'd)

Package	Device	Package to Device I/O Mapping ⁽¹⁾																Un									
		A	B	C	D	E	F	G	H	I	J	K	L	M	N	O	P		Q	R	S	T	U	V	W	X	Y
FFVE1924	XCZU17			65	64	66	67								90	91	93	94	74	73	72	71	70	69	68		
	XCZU19			65	64	66	67								90	91	93	94	74	73	72	71	70	69	68		

Notes:

1. An alphabetical designator, A through Z, is assigned to every bank in a package. I/Os from banks with the same designator are bonded out in the same package. For example, in the FFVF1517 package, the E designator is assigned to bank 67 for the XCZU11 and bank 64 for the XCZU7. These pins, regardless of where they appear on the XCZU11 and XCZU7 device.
2. Bank 66 is partially bonded out in the SBVA484 package (see [Figure 1-10](#)). Bank 67 is partially bonded out in the FFVE1156 and FSVE1156 packages. Bank 68 is partially bonded out in the XCZU63DR, XCZU64DR, XCZU65DR, and XCZU67DR (see [Figure 1-55](#), [Figure 1-74](#), and [Figure 1-76](#)).
3. Migration between the SFVD784 and SFVE784 is possible by following the guidelines in the [Migration Between SFVD784 and SFVE784 Package](#).

Transceiver Quad Migration

For each grouped set of footprint compatible packages listed in [Table 1-8](#), there is a row detailing the each Quad. These groups are labeled according to the regions to the transceiver power supply pins, [Pinout Files](#) linked from [Chapter 3](#), [Package Files](#). For a visual representation of all of this information [Numbering Overview](#) section.

Table 1-8: Transceiver Quad Migration (GTY Quads are in Shaded)

Package	Device	Package to Die Transceiver Mapping ⁽¹⁾												Unbonded								
		A	B	C	D	E	F	G	H	I	J	K	L		M	N	O	P	Q	R	S-Z	AA-AF
SBVA484	XCZU1																					
	XAZU1																					
	XCZU2																					
	XAZU2																					
SFRA484	XCZU3																					
	XAZU3																					
UBVA494	XQZU3																					
	XCZU1																					
UBVA530	XCZU1																					
	XCZU2																					
SFVA625	XCZU3																					
	XCZU1																					
	XAZU1																					
	XCZU2																					
	XAZU2																					
UBVA494	XCZU3																					
	XAZU3																					

Table 1-8: Transceiver Quad Migration (GTY Quads are in Shaded) (Cont'd)

Package	Device	Package to Die Transceiver Mapping ⁽¹⁾																Unbonded	
		A	B	C	D	E	F	G	H	I	J	K	L	M	N	O	P		Q
Power Supply Group	R																		
SFVC784	XCZU1																		
	XAZU1																		
	XCZU2																		
	XAZU2																		
	XCZU3																		
SFV784	XAZU3																		
	XCZU3T	224																	
	XCZU4	224																	
	XAZU4	224																226, 225, 223	
	XCZU5	224																226, 225, 223	
SFRC784	XAZU5																	225	
	XQZU3																	226, 225, 223	
SFVD784	XCZU3T	224	225																
Power Supply Group	R																		
SFVE784 ⁽²⁾	XCZU4	223	224															226, 225	
	XCZU5	223	224															226, 225	
	XCZU5	223	224															226, 225	
Power Supply Group	R																		
FBVB900	XCZU4	223	224	225	226														
	XCZU5	223	224	225	226														
	XCZU7	224	225	226	227												228, 223		
	XAZU7	224	225	226	227												228, 223		
	XQZU5	223	224	225	226												228, 223		
FFRB900	XCZU7	224	225	226	227												228, 223		
	XCZU7	224	225	226	227												228, 223		
Power Supply Group	R																		
FFVC900	XCZU6	228	229	230	128												130, 129, 127		
	XCZU9	228	229	230	128												130, 129, 127		
	XCZU15	228	229	230	128												130, 129, 127		

Table 1-8: Transceiver Quad Migration (GTY Quads are in Shaded) (Cont'd)

Package	Device	Package to Die Transceiver Mapping ⁽¹⁾																Unbonded					
		A	B	C	D	E	F	G	H	I	J	K	L	M	N	O	P		Q	R	S-Z	AA-AF	
FFRC900	XQZU9	228	229	230	128																	130, 129, 127	
	XQZU15	228	229	230	128																		130, 129, 127
Power Supply Group		R			L																		
FFVB1156	XCZU6	228	229	230	128	129	130																127
	XCZU9	228	229	230	128	129	130																127
	XCZU15	228	229	230	128	129	130																127
FFRB1156	XQZU9	228	229	230	128	129	130																127
	XQZU15	228	229	230	128	129	130																127
Power Supply Group		R			L																		
FFVC1156	XCZU7	223	224	225	226	227																	228
	XCZU11	224	225	226	227	228																	131, 130, 129, 128, 127, 22
	XQZU7	223	224	225	226	227																	228
FFRC1156	XQZU11	224	225	226	227	228																	131, 130, 129, 128, 127, 22
	Power Supply Group		L																				
FFVD1156	XCZU21	128	129	130	131																		127
FFRD1156	XQZU21	128	129	130	131																		127

Table 1-8: Transceiver Quad Migration (GTY Quads are in Shaded) (Cont'd)

Package	Device	Package to Die Transceiver Mapping ⁽¹⁾														Unbonded					
		A	B	C	D	E	F	G	H	I	J	K	L	M	N		O	P	Q	R	S-Z
Power Supply Group		L																			
FFVE1156 FSVE1156	XCZU25	128	129																		127
	XCZU27	128	129																		131, 130, 127
	XCZU28	128	129																		131, 130, 127
	XCZU42	127	128																		
	XCZU43	128	129																		131, 130, 127
	XCZU47	128	129																		131, 130, 127
	XCZU48	128	129																		131, 130, 127
	XCZU63	127																			128
	XCZU64	127	128																		
	XCZU65	127	128																		
FFRE1156	XCZU67	127	128																		
	XQZU28	128	129																		131, 130, 127
	XQZU48	128	129																		131, 130, 127
Power Supply Group		R																			
FFVB1517	XCZU11	224	225	226	227																131, 130, 129, 128, 127, 233
	XCZU17	224	225	226	227																134, 133, 132, 131, 130, 1230, 229, 228
	XCZU19	224	225	226	227																134, 133, 132, 131, 130, 1230, 229, 228
	XAZU11	224	225	226	227																131, 130, 129, 128, 127, 233
	XQZU19	224	225	226	227																134, 133, 132, 131, 130, 1230, 229, 228
Power Supply Group		RS																			
FFVF1517	XCZU7	223	224	225	226	227	228														131, 130, 129, 128, 127
	XCZU11	224	225	226	227	228	229	230	231												

Table 1-8: Transceiver Quad Migration (GTY Quads are in Shaded) (Cont'd)

Package	Device	Package to Die Transceiver Mapping ⁽¹⁾																Unbonded			
		A	B	C	D	E	F	G	H	I	J	K	L	M	N	O	P		Q	R	S-Z
Power Supply Group		L																			
	XCZU25	128	129																		127
	XCZU27	128	129	130	131																127
FFVG1517	XCZU28	128	129	130	131																127
	XCZU43	128	129	130	131																127
	XCZU47	128	129	130	131																127
	XCZU48	128	129	130	131																127
FFRG1517	XQZU28	128	129	130	131																127
FSRG1517	XQZU48	128	129	130	131																127
Power Supply Group		RS				RN				L											
FFVC1760	XCZU11	224	225	226	227	228	229	230	231												127
	XCZU17	224	225	226	227	228	229	230	231	128	129	130	131								127
	XCZU19	224	225	226	227	228	229	230	231	128	129	130	131								134, 133, 132, 127, 234, 233
FFRC1760	XQZU11	224	225	226	227	228	229	230	231												127
	XQZU19	224	225	226	227	228	229	230	231	128	129	130	131								134, 133, 132, 127, 234, 233
Power Supply Group		RS				RN				L											
FFVD1760	XCZU17	224	225	226	227	228	229	230	231	232	233	234	128	129	130	131	132	133	134		127
	XCZU19	224	225	226	227	228	229	230	231	232	233	234	128	129	130	131	132	133	134		127
Power Supply Group		L																			
FFVF1760	XCZU29	128	129	130	131																127
	XCZU39	128	129	130	131																127
	XCZU49	128	129	130	131																127
FFVH1760	XCZU46	128	129	130	131																127
	FSVH1760	128	129	130	131																127
FFRF1760	XQZU29	128	129	130	131																127
FSRF1760	XQZU49	128	129	130	131																127

Table 1-8: Transceiver Quad Migration (GTY Quads are in Shaded) (Cont'd)

Package	Device	Package to Die Transceiver Mapping ⁽¹⁾																				Unbon	
		A	B	C	D	E	F	G	H	I	J	K	L	M	N	O	P	Q	R	S-Z	AA-AF		
Power Supply Group		RS										RN											
FFVE1924	XCZU17	224	225	226	227	228	229	230	231	232	233	234											134, 133, 132, 131, 130, 12
	XCZU19	224	225	226	227	228	229	230	231	232	233	234											134, 133, 132, 131, 130, 12

Notes:

1. An alphabetical designator, A through Z, is assigned to every Quad in a package. Transceivers from Quads with the same designator are b that package. For example, in the FFVF1517 package, the E designator is assigned to Quad 228 for the XCZU11 and Quad 227 for the XCZU the same pins, regardless of where they appear on the XCZU11 and XCZU7 device.
2. Migration between the SFVD784 and SFVE784 is possible by following the guidelines in the [Migration Between SFVD784 and SFVE784 Pa](#)

Die Level Bank Numbering Overview

Banking and Clocking Summary

- For each device, not all banks are bonded out in every package.

GTH/GTY Columns

- One GT Quad = Four transceivers = Four GTHE4 or GTYE4 primitives.
- Not all GT Quads are bonded out in every package.
- Also shown are quads labeled with RCAL. This specifies the location of the RCAL masters for each device. With respect to the package, the RCAL masters are located on the same package pin for each package, regardless of the device.
- The XY coordinates shown in each quad correspond to the transceiver channel number found in the pin names for that quad, as shown in [Figure 1-9](#).
- An alphabetic designator is shown in each quad. Each letter corresponds to the columns in [Table 1-7](#) and [Table 1-8](#).
- The power supply group is shown in brackets [] for each quad.

I/O Banks

- Each user HP I/O bank has a total of 52 I/Os where 48 can be used as differential (24 differential pairs) or single-ended I/Os. The remaining four function only as single-ended I/Os. All 52 pads of a bank are not always bonded out to pins.
- A limited number of HP I/O banks have fewer than 52 SelectIO pins. These banks are labeled as partial.
- Each user HD I/O bank has a total of 24 I/Os that can be used as differential (12 differential pairs) or single-ended I/Os.
- Adjacent to each bank is a physical layer (PHY) containing a CMT and other clock resources.
- Adjacent to each bank and PHY is a tile of logic resources that makes up a clock region.
- Banks are arranged in columns and separated into rows which are pitch-matched with adjacent PHY, clock regions, and GT blocks.
- An alphabetic designator is shown in each bank. Each letter corresponds to the columns in [Table 1-7](#) and [Table 1-8](#).

Clocking

- Each bank has four pairs of global clock (GC or HDGC) inputs for four differential or four single-ended clock inputs. Single-ended clock inputs should be connected to the P-side of the differential pair.
- Clock signals are distributed through global buffers driving routing and distribution networks to reach any clock region, I/O, or GT.
- Global clock inputs can connect to an MMCM and two PLLs within the horizontally adjacent CMT.

Bank Locations of Dedicated and Multi-Function Pins

- All dedicated configuration I/Os and HD I/Os are 3.3V capable.

Processor (PS) Blocks

- MIO pins are shared between banks 500, 501, and 502.
- Configuration pins are in bank 503.
- DDR memory pins are in bank 504.
- Transceiver pins are in the PS-GTR quad 505.

SYSMON, Configuration, PCIe, Interlaken, and 100GE Integrated Blocks

- Configuration: Configuration block.
- SYSMON/Configuration: Block shared between the SYSMONE4 and configuration.
- PCIe: Integrated block for PCIe.
Note: PCIe blocks with an additional (Tandem) label support tandem configuration.
- ILKN: Interlaken block.
- CMAC: 100G Ethernet block.

Device Diagrams

Figure 1-3 shows an example diagram with a brief explanation for each component.

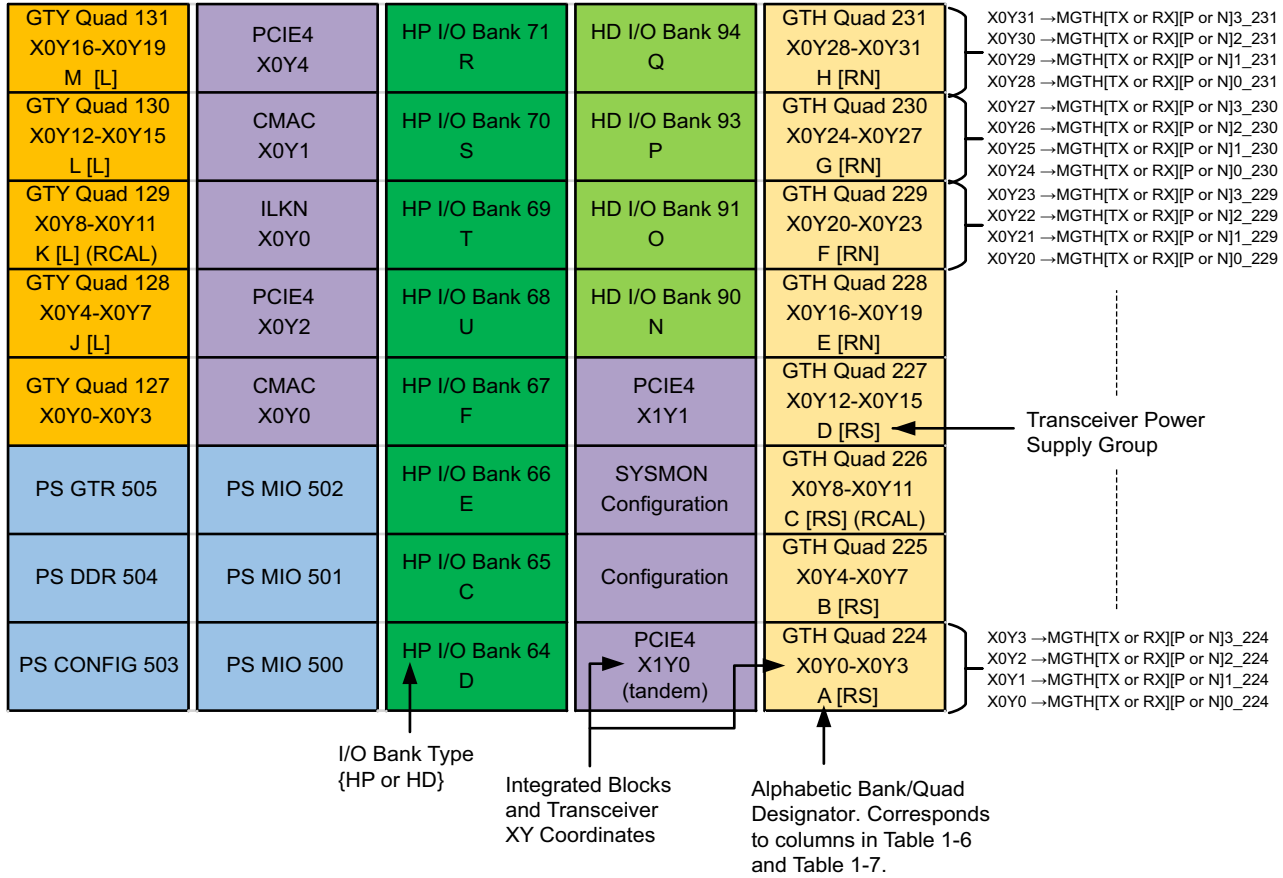

X17155-060219

Figure 1-3: Example Device Diagram

Figure 1-4 through Figure 1-76 show a die view of each device followed by a view with respect to each available package. The available resources by device and package are detailed in the *Zynq UltraScale+ MPSoC Overview (DS891)* or *Zynq UltraScale+ RFSoc Overview (DS889)*.

XCZU1 Bank Diagram Overview

PS GTR 505	PS MIO 502	SYSMON Configuration	HP I/O Bank 66
PS DDR 504	PS MIO 501	Configuration	HP I/O Bank 65
PS CONFIG 503	PS MIO 500	HD I/O Bank 44	HP I/O Bank 64

X26100-121921

Figure 1-4: XCZU1 Banks

Bank Diagram by Package for XCZU1

PS GTR 505	PS MIO 502	SYSMON Configuration	HP I/O Bank 66 D (Partial)
PS DDR 504 (Partial)	PS MIO 501	Configuration	HP I/O Bank 65 C
PS CONFIG 503	PS MIO 500	HD I/O Bank 44 E	HP I/O Bank 64

X26102-121921

Figure 1-5: XCZU1 Banks in SBVA484 Package

PS GTR 505	PS MIO 502	SYSMON Configuration	HP I/O Bank 66 D (Partial)
PS DDR 504 (Partial)	PS MIO 501	Configuration	HP I/O Bank 65 C
PS CONFIG 503	PS MIO 500	HD I/O Bank 44	HP I/O Bank 64

X26101-121921

Figure 1-6: XCZU1 Banks in UBVA494 Package



IMPORTANT: For the devices in the UBVA494 package shown in [Figure 1-6](#), the HP I/Os in bank 66 are powered by VCCO_65.

PS GTR 505	PS MIO 502	SYSMON Configuration	HP I/O Bank 66 D
PS DDR 504 (Partial)	PS MIO 501	Configuration	HP I/O Bank 65 C
PS CONFIG 503	PS MIO 500	HD I/O Bank 44 E	HP I/O Bank 64 B

X26103-121921

Figure 1-7: XCZU1 Banks in SBVA625 Package

PS GTR 505	PS MIO 502	SYSMON Configuration	HP I/O Bank 66 D
PS DDR 504	PS MIO 501	Configuration	HP I/O Bank 65 C
PS CONFIG 503	PS MIO 500	HD I/O Bank 44 O	HP I/O Bank 64 B

X26104-121921

Figure 1-8: XCZU1 Banks in SFVC784 Package

XCZU2, XAZU2, XCZU3, XAZU3, and XQZU3 Bank Diagram Overview

PS GTR 505	PS MIO 502	HD I/O Bank 26	SYSMON Configuration	HP I/O Bank 66
PS DDR 504	PS MIO 501	HD I/O Bank 25	Configuration	HP I/O Bank 65
PS CONFIG 503	PS MIO 500	HD I/O Bank 24	HD I/O Bank 44	HP I/O Bank 64

X15118-060720

Figure 1-9: XCZU2, XAZU2, XCZU3, XAZU3, and XQZU3 Banks

Bank Diagram by Package for XCZU2, XAZU2, XCZU3, XAZU3, and XQZU3

PS GTR 505	PS MIO 502	HD I/O Bank 26 B	SYSMON Configuration	HP I/O Bank 66 D (Partial) VCCO_65
PS DDR 504 (Partial)	PS MIO 501	HD I/O Bank 25	Configuration	HP I/O Bank 65 C
PS CONFIG 503	PS MIO 500	HD I/O Bank 24	HD I/O Bank 44	HP I/O Bank 64

X15119-082224

Figure 1-10: XCZU2, XAZU2, XCZU3, and XAZU3 Banks in SBVA484 Package



IMPORTANT: For the devices in the SBVA484 package shown in [Figure 1-10](#), the HP I/Os in bank 66 are powered by VCCO_65.

PS GTR 505	PS MIO 502	HD I/O Bank 26 B	SYSMON Configuration	HP I/O Bank 66 D (Partial) VCCO_65
PS DDR 504 (Partial)	PS MIO 501	HD I/O Bank 25	Configuration	HP I/O Bank 65 C
PS CONFIG 503	PS MIO 500	HD I/O Bank 24	HD I/O Bank 44	HP I/O Bank 64

X25451-082224

Figure 1-11: XCZU2 and XCZU3 Banks in UBVA530 Package



IMPORTANT: For the devices in the UBVA530 package shown in Figure 1-11, the HP I/Os in bank 66 are powered by VCCO_65.

PS GTR 505	PS MIO 502	HD I/O Bank 26 E	SYSMON Configuration	HP I/O Bank 66 D
PS DDR 504 (Partial)	PS MIO 501	HD I/O Bank 25	Configuration	HP I/O Bank 65 C
PS CONFIG 503	PS MIO 500	HD I/O Bank 24	HD I/O Bank 44	HP I/O Bank 64 B

X15120-060720

Figure 1-12: XCZU2, XAZU2, XCZU3, and XAZU3 Banks in SFVA625 Package

PS GTR 505	PS MIO 502	HD I/O Bank 26 F	SYSMON Configuration	HP I/O Bank 66 D
PS DDR 504	PS MIO 501	HD I/O Bank 25 E	Configuration	HP I/O Bank 65 C
PS CONFIG 503	PS MIO 500	HD I/O Bank 24 N	HD I/O Bank 44 O	HP I/O Bank 64 B

X15121-060720

Figure 1-13: XCZU2, XAZU2, XCZU3, XAZU3, and XQZU3 Banks in SFVC784 Package

XCZU3T Bank Diagram Overview

PS GTR 505	PS MIO 502	HD I/O Bank 46	SYSMON Configuration	HP I/O Bank 66
PS DDR 504	PS MIO 501	HD I/O Bank 45	Configuration	GTH Quad 225 X0Y4-X0Y7
PS CONFIG 503	PS MIO 500	HD I/O Bank 44	PCIE4 X0Y0	GTH Quad 224 X0Y0-X0Y3 (RCAL)

X27739-020723

Figure 1-14: XCZU3T Banks

Bank Diagram by Package for XCZU3T

PS GTR 505	PS MIO 502	HD I/O Bank 46 F	SYSMON Configuration	HP I/O Bank 66 D
PS DDR 504	PS MIO 501	HD I/O Bank 45 E	Configuration	GTH Quad 225 X0Y4-X0Y7
PS CONFIG 503	PS MIO 500	HD I/O Bank 44 N	PCIE4 X0Y0	GTH Quad 224 X0Y0-X0Y3 A [R] (RCAL)

X27740-020723

Figure 1-15: XCZU3T Banks in SFVC784 Package

PS GTR 505	PS MIO 502	HD I/O Bank 46 F	SYSMON Configuration	HP I/O Bank 66 D
PS DDR 504	PS MIO 501	HD I/O Bank 45 E	Configuration	GTH Quad 225 X0Y4-X0Y7 B [R]
PS CONFIG 503	PS MIO 500	HD I/O Bank 44 N	PCIE4 X0Y0	GTH Quad 224 X0Y0-X0Y3 A [R] (RCAL)

X27741-020723

Figure 1-16: XCZU3T Banks in SFVD784 Package

Note: Migration between the SFVD784 and SFVE784 is possible by following the guidelines in [Migration Between SFVD784 and SFVE784 Packages, page 34](#).

XCZU4, XAZU4, XCZU5, XAZU5, and XQZU5 Bank Diagram Overview

PS GTR 505	PS MIO 502	HD I/O Bank 46	HP I/O Bank 66	SYSMON Configuration	GTH Quad 226 X0Y12-X0Y15
PS DDR 504	PS MIO 501	HD I/O Bank 45	HP I/O Bank 65	Configuration	GTH Quad 225 X0Y8-X0Y11
PS CONFIG 503	PS MIO 500	HD I/O Bank 44	HP I/O Bank 64	PCIE4 X0Y1 (tandem)	GTH Quad 224 X0Y4-X0Y7 (RCAL)
		HD I/O Bank 43	HP I/O Bank 63	PCIE4 X0Y0	GTH Quad 223 X0Y0-X0Y3

X15122-060720

Figure 1-17: XCZU4, XAZU4, XCZU5, XAZU5, and XQZU5 Banks

Bank Diagram by Package for XCZU4, XAZU4EV, XCZU5, XAZU5EV, and XQZU5

PS GTR 505	PS MIO 502	HD I/O Bank 46 F	HP I/O Bank 66 D	SYSMON Configuration	GTH Quad 226 X0Y12-X0Y15
PS DDR 504	PS MIO 501	HD I/O Bank 45 E	HP I/O Bank 65 C	Configuration	GTH Quad 225 X0Y8-X0Y11
PS CONFIG 503	PS MIO 500	HD I/O Bank 44 N	HP I/O Bank 64 B	PCIE4 X0Y1 (tandem)	GTH Quad 224 X0Y4-X0Y7 A [R] (RCAL)
		HD I/O Bank 43 O	HP I/O Bank 63	PCIE4 X0Y0	GTH Quad 223 X0Y0-X0Y3

X15124-111316

Figure 1-18: XCZU4, XAZU4EV, XCZU5, and XAZU5EV Banks in SFVC784 Package and XQZU5 Banks in SFRC784 Package

Note: Migration between the SFVD784 and SFVE784 is possible by following the guidelines in [Migration Between SFVD784 and SFVE784 Packages, page 34](#).

PS GTR 505	PS MIO 502	HD I/O Bank 46 F	HP I/O Bank 66 C (Partial) VCCO_65	SYSMON Configuration	GTH Quad 226 X0Y12-X0Y15
PS DDR 504	PS MIO 501	HD I/O Bank 45 E	HP I/O Bank 65 D	Configuration	GTH Quad 225 X0Y8-X0Y11
PS CONFIG 503	PS MIO 500	HD I/O Bank 44	HP I/O Bank 64	PCIE4_CFG_424 X0Y1	GTH Quad 224 X0Y4-X0Y7 B [R] (RCAL)
		HD I/O Bank 43 N	HP I/O Bank 63	PCIE4_423 X0Y0	GTH Quad 223 X0Y0-X0Y3 A [R]

X29471-082224

Figure 1-19: XCZU4, XAZU4EV, XCZU5, and XAZU5EV Banks in SFVE784 Package

Migration between the SFVD784 and SFVE784 is possible by following the guidelines in the [Migration Between SFVD784 and SFVE784 Packages](#) section.

PS GTR 505	PS MIO 502	HD I/O Bank 46 N	HP I/O Bank 66 D	SYSMON Configuration	GTH Quad 226 X0Y12-X0Y15 D [R]
PS DDR 504	PS MIO 501	HD I/O Bank 45 O	HP I/O Bank 65 C	Configuration	GTH Quad 225 X0Y8-X0Y11 C [R]
PS CONFIG 503	PS MIO 500	HD I/O Bank 44	HP I/O Bank 64 B	PCIE4 X0Y1	GTH Quad 224 X0Y4-X0Y7 B [R] (RCAL)
		HD I/O Bank 43	HP I/O Bank 63	PCIE4 X0Y0	GTH Quad 223 X0Y0-X0Y3 A [R]

X15123-112916

Figure 1-20: XCZU4 and XCZU5 Banks in FBVB900 Package and XQZU5 Banks in FFRB900 Package

XCZU7, XAZU7, and XQZU7 Bank Diagram Overview

HP I/O Bank 28	HD I/O Bank 48	HP I/O Bank 68	HD I/O Bank 88	GTH Quad 228 X0Y20-X0Y23
HP I/O Bank 27	HD I/O Bank 47	HP I/O Bank 67	HD I/O Bank 87	GTH Quad 227 X0Y16-X0Y19
PS GTR 505	PS MIO 502	HP I/O Bank 66	SYSMON Configuration	GTH Quad 226 X0Y12-X0Y15
PS DDR 504	PS MIO 501	HP I/O Bank 65	Configuration	GTH Quad 225 X0Y8-X0Y11
PS CONFIG 503	PS MIO 500	HP I/O Bank 64	PCIE4 X0Y1 (tandem)	GTH Quad 224 X0Y4-X0Y7 (RCAL)
		HP I/O Bank 63	PCIE4 X0Y0	GTH Quad 223 X0Y0-X0Y3

X15125-111316

Figure 1-21: XCZU7, XAZU7, and XQZU7 Banks

Bank Diagram by Package for XCZU7, XAZU7, and XQZU7

HP I/O Bank 28	HD I/O Bank 48 O	HP I/O Bank 68	HD I/O Bank 88	GTH Quad 228 X0Y20-X0Y23
HP I/O Bank 27	HD I/O Bank 47 N	HP I/O Bank 67	HD I/O Bank 87	GTH Quad 227 X0Y16-X0Y19 D [R]
PS GTR 505	PS MIO 502	HP I/O Bank 66 D	SYSMON Configuration	GTH Quad 226 X0Y12-X0Y15 C [R]
PS DDR 504	PS MIO 501	HP I/O Bank 65 C	Configuration	GTH Quad 225 X0Y8-X0Y11 B [R]
PS CONFIG 503	PS MIO 500	HP I/O Bank 64 B	PCIE4 X0Y1	GTH Quad 224 X0Y4-X0Y7 A [R] (RCAL)
		HP I/O Bank 63	PCIE4 X0Y0	GTH Quad 223 X0Y0-X0Y3

X15126-112916

Figure 1-22: XCZU7 and XAZU7 Banks in FBVB900 Package and XQZU7 Banks in FFRB900 Package

HP I/O Bank 28 R	HD I/O Bank 48	HP I/O Bank 68 P	HD I/O Bank 88 O	GTH Quad 228 X0Y20-X0Y23
HP I/O Bank 27	HD I/O Bank 47	HP I/O Bank 67 Q	HD I/O Bank 87 N	GTH Quad 227 X0Y16-X0Y19 E [R]
PS GTR 505	PS MIO 502	HP I/O Bank 66 D	SYSMON Configuration	GTH Quad 226 X0Y12-X0Y15 D [R]
PS DDR 504	PS MIO 501	HP I/O Bank 65 C	Configuration	GTH Quad 225 X0Y8-X0Y11 C [R]
PS CONFIG 503	PS MIO 500	HP I/O Bank 64 B	PCIE4 X0Y1 (tandem)	GTH Quad 224 X0Y4-X0Y7 B [R] (RCAL)
		HP I/O Bank 63	PCIE4 X0Y0	GTH Quad 223 X0Y0-X0Y3 A [R]

X15127-111316

Figure 1-23: XCZU7 Banks in FFVC1156 Package and XQZU7 Banks in FFRC1156 Package

HP I/O Bank 28 R	HD I/O Bank 48	HP I/O Bank 68 Q	HD I/O Bank 88 O	GTH Quad 228 X0Y20-X0Y23 F [RN]
HP I/O Bank 27 S	HD I/O Bank 47	HP I/O Bank 67 P	HD I/O Bank 87 N	GTH Quad 227 X0Y16-X0Y19 E [RN]
PS GTR 505	PS MIO 502	HP I/O Bank 66 D	SYSMON Configuration	GTH Quad 226 X0Y12-X0Y15 D [RS]
PS DDR 504	PS MIO 501	HP I/O Bank 65 C	Configuration	GTH Quad 225 X0Y8-X0Y11 C [RS]
PS CONFIG 503	PS MIO 500	HP I/O Bank 64 E	PCIE4 X0Y1 (tandem)	GTH Quad 224 X0Y4-X0Y7 B [RS] (RCAL)
		HP I/O Bank 63 F	PCIE4 X0Y0	GTH Quad 223 X0Y0-X0Y3 A [RS]

X15128-111316

Figure 1-24: XCZU7 Banks in FFVF1517 Package

XCZU6, XCZU9, and XQZU9 Bank Diagram Overview

GTH Quad 130 X0Y12-X0Y15		HD I/O Bank 50	GTH Quad 230 X1Y12-X1Y15
GTH Quad 129 X0Y8-X0Y11		HD I/O Bank 49	GTH Quad 229 X1Y8-X1Y11
GTH Quad 128 X0Y4-X0Y7 (RCAL)		HD I/O Bank 48	GTH Quad 228 X1Y4-X1Y7 (RCAL)
GTH Quad 127 X0Y0-X0Y3		HD I/O Bank 47	HP I/O Bank 67
PS GTR 505	PS MIO 502	SYSMON Configuration	HP I/O Bank 66
PS DDR 504	PS MIO 501	Configuration	HP I/O Bank 65
PS CONFIG 503	PS MIO 500	HD I/O Bank 44	HP I/O Bank 64

X15129-061420

Figure 1-25: XCZU6, XCZU9, and XQZU9 Banks

Bank Diagram by Package for XCZU6, XCZU9, and XQZU9

GTH Quad 130 X0Y12-X0Y15		HD I/O Bank 50	GTH Quad 230 X1Y12-X1Y15 C [R]
GTH Quad 129 X0Y8-X0Y11		HD I/O Bank 49	GTH Quad 229 X1Y8-X1Y11 B [R]
GTH Quad 128 X0Y4-X0Y7 D [L] (RCAL)		HD I/O Bank 48 N	GTH Quad 228 X1Y4-X1Y7 A [R] (RCAL)
GTH Quad 127 X0Y0-X0Y3		HD I/O Bank 47 O	HP I/O Bank 67
PS GTR 505	PS MIO 502	SYSMON Configuration	HP I/O Bank 66 D
PS DDR 504	PS MIO 501	Configuration	HP I/O Bank 65 C
PS CONFIG 503	PS MIO 500	HD I/O Bank 44	HP I/O Bank 64 B

X15130-061420

Figure 1-26: XCZU6 and XCZU9 Banks in FFVC900 Package and XQZU9 in FFRC900 Package

GTH Quad 130 X0Y12-X0Y15 F [L]		HD I/O Bank 50 Q	GTH Quad 230 X1Y12-X1Y15 C [R]
GTH Quad 129 X0Y8-X0Y11 E [L]		HD I/O Bank 49 P	GTH Quad 229 X1Y8-X1Y11 B [R]
GTH Quad 128 X0Y4-X0Y7 D [L] (RCAL)		HD I/O Bank 48 O	GTH Quad 228 X1Y4-X1Y7 A [R] (RCAL)
GTH Quad 127 X0Y0-X0Y3		HD I/O Bank 47 N	HP I/O Bank 67 E
PS GTR 505	PS MIO 502	SYSMON Configuration	HP I/O Bank 66 D
PS DDR 504	PS MIO 501	Configuration	HP I/O Bank 65 C
PS CONFIG 503	PS MIO 500	HD I/O Bank 44 A	HP I/O Bank 64 B

X15131-061420

Figure 1-27: XCZU6 and XCZU9 Banks in FFVB1156 Package and XQZU9 in FFRB1156 Package

XCZU11, XAZU11, and XQZU11 Bank Diagram Overview

GTY Quad 131 X0Y16-X0Y19	PCIE4 X0Y3	HP I/O Bank 71	HD I/O Bank 91	GTH Quad 231 X0Y28-X0Y31
GTY Quad 130 X0Y12-X0Y15	CMAC X0Y1	HP I/O Bank 70	HD I/O Bank 90	GTH Quad 230 X0Y24-X0Y27
GTY Quad 129 X0Y8-X0Y11 (RCAL)	ILKN X0Y0	HP I/O Bank 69	HD I/O Bank 89	GTH Quad 229 X0Y20-X0Y23
GTY Quad 128 X0Y4-X0Y7	PCIE4 X0Y2	HP I/O Bank 68	HD I/O Bank 88	GTH Quad 228 X0Y16-X0Y19
GTY Quad 127 X0Y0-X0Y3	CMAC X0Y0	HP I/O Bank 67	PCIE4 X1Y1	GTH Quad 227 X0Y12-X0Y15
PS GTR 505	PS MIO 502	HP I/O Bank 66	SYSMON Configuration	GTH Quad 226 X0Y8-X0Y11 (RCAL)
PS DDR 504	PS MIO 501	HP I/O Bank 65	Configuration	GTH Quad 225 X0Y4-X0Y7
PS CONFIG 503	PS MIO 500	HP I/O Bank 64	PCIE4 X1Y0 (tandem)	GTH Quad 224 X0Y0-X0Y3

X15132-121517

Figure 1-28: XCZU11, XAZU11, and XQZU11 Banks

Bank Diagram by Package for XCZU11, XAZU11, and XQZU11

GTU Quad 131 X0Y16-X0Y19	PCIE4 X0Y3	HP I/O Bank 71	HD I/O Bank 91	GTH Quad 231 X0Y28-X0Y31
GTU Quad 130 X0Y12-X0Y15	CMAC X0Y1	HP I/O Bank 70	HD I/O Bank 90	GTH Quad 230 X0Y24-X0Y27
GTU Quad 129 X0Y8-X0Y11 (RCAL)	ILKN X0Y0	HP I/O Bank 69 P	HD I/O Bank 89 O	GTH Quad 229 X0Y20-X0Y23
GTU Quad 128 X0Y4-X0Y7	PCIE4 X0Y2	HP I/O Bank 68 Q	HD I/O Bank 88 N	GTH Quad 228 X0Y16-X0Y19 E [R]
GTU Quad 127 X0Y0-X0Y3	CMAC X0Y0	HP I/O Bank 67 R	PCIE4 X1Y1	GTH Quad 227 X0Y12-X0Y15 D [R]
PS GTR 505	PS MIO 502	HP I/O Bank 66 D	SYSMON Configuration	GTH Quad 226 X0Y8-X0Y11 C [R] (RCAL)
PS DDR 504	PS MIO 501	HP I/O Bank 65 C	Configuration	GTH Quad 225 X0Y4-X0Y7 B [R]
PS CONFIG 503	PS MIO 500	HP I/O Bank 64 B	PCIE4 X1Y0 (tandem)	GTH Quad 224 X0Y0-X0Y3 A [R]

X15133-121517

Figure 1-29: XCZU11 Banks in FFVC1156 Package and XQZU11 Banks in FFRC1156 Package

GTY Quad 131 X0Y16-X0Y19	PCIE4 X0Y3	HP I/O Bank 71 T	HD I/O Bank 91	GTH Quad 231 X0Y28-X0Y31
GTY Quad 130 X0Y12-X0Y15	CMAC X0Y1	HP I/O Bank 70 U	HD I/O Bank 90 P	GTH Quad 230 X0Y24-X0Y27
GTY Quad 129 X0Y8-X0Y11 (RCAL)	ILKN X0Y0	HP I/O Bank 69 V	HD I/O Bank 89 O	GTH Quad 229 X0Y20-X0Y23
GTY Quad 128 X0Y4-X0Y7	PCIE4 X0Y2	HP I/O Bank 68 W	HD I/O Bank 88 N	GTH Quad 228 X0Y16-X0Y19
GTY Quad 127 X0Y0-X0Y3	CMAC X0Y0	HP I/O Bank 67 X	PCIE4 X1Y1	GTH Quad 227 X0Y12-X0Y15 D [R]
PS GTR 505	PS MIO 502	HP I/O Bank 66 E	SYSMON Configuration	GTH Quad 226 X0Y8-X0Y11 C [R] (RCAL)
PS DDR 504	PS MIO 501	HP I/O Bank 65 C	Configuration	GTH Quad 225 X0Y4-X0Y7 B [R]
PS CONFIG 503	PS MIO 500	HP I/O Bank 64 D	PCIE4 X1Y0 (tandem)	GTH Quad 224 X0Y0-X0Y3 A [R]

X15134-121517

Figure 1-30: XCZU11 Banks in FFVB1517 Package

GTY Quad 131 X0Y16-X0Y19	PCIE4 X0Y3	HP I/O Bank 71 Q	HD I/O Bank 91	GTH Quad 231 X0Y28-X0Y31 H [RN]
GTY Quad 130 X0Y12-X0Y15	CMAC X0Y1	HP I/O Bank 70 P	HD I/O Bank 90	GTH Quad 230 X0Y24-X0Y27 G [RN]
GTY Quad 129 X0Y8-X0Y11 (RCAL)	ILKN X0Y0	HP I/O Bank 69 R	HD I/O Bank 89 O	GTH Quad 229 X0Y20-X0Y23 F [RN]
GTY Quad 128 X0Y4-X0Y7	PCIE4 X0Y2	HP I/O Bank 68 S	HD I/O Bank 88 N	GTH Quad 228 X0Y16-X0Y19 E [RN]
GTY Quad 127 X0Y0-X0Y3	CMAC X0Y0	HP I/O Bank 67 E	PCIE4 X1Y1	GTH Quad 227 X0Y12-X0Y15 D [RS]
PS GTR 505	PS MIO 502	HP I/O Bank 66 D	SYSMON Configuration	GTH Quad 226 X0Y8-X0Y11 C [RS] (RCAL)
PS DDR 504	PS MIO 501	HP I/O Bank 65 C	Configuration	GTH Quad 225 X0Y4-X0Y7 B [RS]
PS CONFIG 503	PS MIO 500	HP I/O Bank 64 F	PCIE4 X1Y0 (tandem)	GTH Quad 224 X0Y0-X0Y3 A [RS]

X15135-121517

Figure 1-31: XCZU11 and XAZU11 Banks in FVVF1517 Package

GTY Quad 131 X0Y16-X0Y19 M [L]	PCIE4 X0Y3	HP I/O Bank 71 R	HD I/O Bank 91 Q	GTH Quad 231 X0Y28-X0Y31 H [RN]
GTY Quad 130 X0Y12-X0Y15 L [L]	CMAC X0Y1	HP I/O Bank 70 S	HD I/O Bank 90 P	GTH Quad 230 X0Y24-X0Y27 G [RN]
GTY Quad 129 X0Y8-X0Y11 K [L] (RCAL)	ILKN X0Y0	HP I/O Bank 69 T	HD I/O Bank 89 O	GTH Quad 229 X0Y20-X0Y23 F [RN]
GTY Quad 128 X0Y4-X0Y7 J [L]	PCIE4 X0Y2	HP I/O Bank 68 U	HD I/O Bank 88 N	GTH Quad 228 X0Y16-X0Y19 E [RN]
GTY Quad 127 X0Y0-X0Y3	CMAC X0Y0	HP I/O Bank 67 F	PCIE4 X1Y1	GTH Quad 227 X0Y12-X0Y15 D [RS]
PS GTR 505	PS MIO 502	HP I/O Bank 66 E	SYSMON Configuration	GTH Quad 226 X0Y8-X0Y11 C [RS] (RCAL)
PS DDR 504	PS MIO 501	HP I/O Bank 65 C	Configuration	GTH Quad 225 X0Y4-X0Y7 B [RS]
PS CONFIG 503	PS MIO 500	HP I/O Bank 64 D	PCIE4 X1Y0 (tandem)	GTH Quad 224 X0Y0-X0Y3 A [RS]

X15136-121517

Figure 1-32: XCZU11 Banks in FFVC1760 Package and XQZU11 Banks in FFRC1760 Package

XCZU15 and XQZU15 Bank Diagrams

GTH Quad 130 X0Y12-X0Y15		HD I/O Bank 50	GTH Quad 230 X1Y12-X1Y15
GTH Quad 129 X0Y8-X0Y11		HD I/O Bank 49	GTH Quad 229 X1Y8-X1Y11
GTH Quad 128 X0Y4-X0Y7 (RCAL)		HD I/O Bank 48	GTH Quad 228 X1Y4-X1Y7 (RCAL)
GTH Quad 127 X0Y0-X0Y3		HD I/O Bank 47	HP I/O Bank 67
PS GTR 505	PS MIO 502	SYSMON Configuration	HP I/O Bank 66
PS DDR 504	PS MIO 501	Configuration	HP I/O Bank 65
PS CONFIG 503	PS MIO 500	HD I/O Bank 44	HP I/O Bank 64

X15137-061420

Figure 1-33: XCZU15 and XQZU15 Banks

Bank Diagram by Package for XCZU15 and XQZU15

GTH Quad 130 X0Y12-X0Y15		HD I/O Bank 50	GTH Quad 230 X1Y12-X1Y15 C [R]
GTH Quad 129 X0Y8-X0Y11		HD I/O Bank 49	GTH Quad 229 X1Y8-X1Y11 B [R]
GTH Quad 128 X0Y4-X0Y7 D [L] (RCAL)		HD I/O Bank 48 N	GTH Quad 228 X1Y4-X1Y7 A [R] (RCAL)
GTH Quad 127 X0Y0-X0Y3		HD I/O Bank 47 O	HP I/O Bank 67
PS GTR 505	PS MIO 502	SYSMON Configuration	HP I/O Bank 66 D
PS DDR 504	PS MIO 501	Configuration	HP I/O Bank 65 C
PS CONFIG 503	PS MIO 500	HD I/O Bank 44	HP I/O Bank 64 B

X15138-061420

Figure 1-34: XCZU15 Banks in FFVC900 Package and XQZU15 Banks in FFRC900 Package

GTH Quad 130 X0Y12-X0Y15 F [L]		HD I/O Bank 50 Q	GTH Quad 230 X1Y12-X1Y15 C [R]
GTH Quad 129 X0Y8-X0Y11 E [L]		HD I/O Bank 49 P	GTH Quad 229 X1Y8-X1Y11 B [R]
GTH Quad 128 X0Y4-X0Y7 D [L] (RCAL)		HD I/O Bank 48 O	GTH Quad 228 X1Y4-X1Y7 A [R] (RCAL)
GTH Quad 127 X0Y0-X0Y3		HD I/O Bank 47 N	HP I/O Bank 67 E
PS GTR 505	PS MIO 502	SYSMON Configuration	HP I/O Bank 66 D
PS DDR 504	PS MIO 501	Configuration	HP I/O Bank 65 C
PS CONFIG 503	PS MIO 500	HD I/O Bank 44 A	HP I/O Bank 64 B

X15139-061420

Figure 1-35: XCZU15 Banks in FFVB1156 Package and XQZU15 Banks in FFRB1156 Package

XCZU17, XCZU19, and XQZU19 Bank Diagram Overview

GTY Quad 134 X0Y28-X0Y31	CMAC X0Y3	HP I/O Bank 74	HD I/O Bank 94	GTH Quad 234 X0Y40-X0Y43
GTY Quad 133 X0Y24-X0Y27	ILKN X0Y2	HP I/O Bank 73	HD I/O Bank 93	GTH Quad 233 X0Y36-X0Y39
GTY Quad 132 X0Y20-X0Y23	CMAC X0Y2	HP I/O Bank 72	ILKN X1Y1	GTH Quad 232 X0Y32-X0Y35
GTY Quad 131 X0Y16-X0Y19	PCIE4 X0Y3	HP I/O Bank 71	HD I/O Bank 91	GTH Quad 231 X0Y28-X0Y31
GTY Quad 130 X0Y12-X0Y15	CMAC X0Y1	HP I/O Bank 70	HD I/O Bank 90	GTH Quad 230 X0Y24-X0Y27
GTY Quad 129 X0Y8-X0Y11 (RCAL)	ILKN X0Y0	HP I/O Bank 69	ILKN X1Y0	GTH Quad 229 X0Y20-X0Y23
GTY Quad 128 X0Y4-X0Y7	PCIE4 X0Y2	HP I/O Bank 68	PCIE4 X1Y2	GTH Quad 228 X0Y16-X0Y19
GTY Quad 127 X0Y0-X0Y3	CMAC X0Y0	HP I/O Bank 67	PCIE4 X1Y1	GTH Quad 227 X0Y12-X0Y15
PS GTR 505	PS MIO 502	HP I/O Bank 66	SYSMON Configuration	GTH Quad 226 X0Y8-X0Y11 (RCAL)
PS DDR 504	PS MIO 501	HP I/O Bank 65	Configuration	GTH Quad 225 X0Y4-X0Y7
PS CONFIG 503	PS MIO 500	HP I/O Bank 64	PCIE4 X1Y0 (tandem)	GTH Quad 224 X0Y0-X0Y3

X15140-071417

Figure 1-36: XCZU17, XCZU19, and XQZU19 Banks

Bank Diagram by Package for XCZU17, XCZU19, and XQZU19

GTY Quad 134 X0Y28-X0Y31	CMAC X0Y3	HP I/O Bank 74 Q	HD I/O Bank 94	GTH Quad 234 X0Y40-X0Y43
GTY Quad 133 X0Y24-X0Y27	ILKN X0Y2	HP I/O Bank 73 R	HD I/O Bank 93 P	GTH Quad 233 X0Y36-X0Y39
GTY Quad 132 X0Y20-X0Y23	CMAC X0Y2	HP I/O Bank 72 S	ILKN X1Y1	GTH Quad 232 X0Y32-X0Y35
GTY Quad 131 X0Y16-X0Y19	PCIE4 X0Y3	HP I/O Bank 71 T	HD I/O Bank 91 O	GTH Quad 231 X0Y28-X0Y31
GTY Quad 130 X0Y12-X0Y15	CMAC X0Y1	HP I/O Bank 70 U	HD I/O Bank 90 N	GTH Quad 230 X0Y24-X0Y27
GTY Quad 129 X0Y8-X0Y11 (RCAL)	ILKN X0Y0	HP I/O Bank 69 V	ILKN X1Y0	GTH Quad 229 X0Y20-X0Y23
GTY Quad 128 X0Y4-X0Y7	PCIE4 X0Y2	HP I/O Bank 68 W	PCIE4 X1Y2	GTH Quad 228 X0Y16-X0Y19
GTY Quad 127 X0Y0-X0Y3	CMAC X0Y0	HP I/O Bank 67 X	PCIE4 X1Y1	GTH Quad 227 X0Y12-X0Y15 D [R]
PS GTR 505	PS MIO 502	HP I/O Bank 66 E	SYSMON Configuration	GTH Quad 226 X0Y8-X0Y11 C [R] (RCAL)
PS DDR 504	PS MIO 501	HP I/O Bank 65 C	Configuration	GTH Quad 225 X0Y4-X0Y7 B [R]
PS CONFIG 503	PS MIO 500	HP I/O Bank 64 D	PCIE4 X1Y0 (tandem)	GTH Quad 224 X0Y0-X0Y3 A [R]

X15141-071417

Figure 1-37: XCZU17 and XCZU19 Banks in FFVB1517 Package and XQZU19 Banks in FFRB1517 Package

GTY Quad 134 X0Y28-X0Y31	CMAC X0Y3	HP I/O Bank 74	HD I/O Bank 94 Q	GTH Quad 234 X0Y40-X0Y43
GTY Quad 133 X0Y24-X0Y27	ILKN X0Y2	HP I/O Bank 73	HD I/O Bank 93 P	GTH Quad 233 X0Y36-X0Y39
GTY Quad 132 X0Y20-X0Y23	CMAC X0Y2	HP I/O Bank 72	ILKN X1Y1	GTH Quad 232 X0Y32-X0Y35
GTY Quad 131 X0Y16-X0Y19 M [L]	PCIE4 X0Y3	HP I/O Bank 71 R	HD I/O Bank 91 O	GTH Quad 231 X0Y28-X0Y31 H [RN]
GTY Quad 130 X0Y12-X0Y15 L [L]	CMAC X0Y1	HP I/O Bank 70 S	HD I/O Bank 90 N	GTH Quad 230 X0Y24-X0Y27 G [RN]
GTY Quad 129 X0Y8-X0Y11 K [L] (RCAL)	ILKN X0Y0	HP I/O Bank 69 T	ILKN X1Y0	GTH Quad 229 X0Y20-X0Y23 F [RN]
GTY Quad 128 X0Y4-X0Y7 J [L]	PCIE4 X0Y2	HP I/O Bank 68 U	PCIE4 X1Y2	GTH Quad 228 X0Y16-X0Y19 E [RN]
GTY Quad 127 X0Y0-X0Y3	CMAC X0Y0	HP I/O Bank 67 F	PCIE4 X1Y1	GTH Quad 227 X0Y12-X0Y15 D [RS]
PS GTR 505	PS MIO 502	HP I/O Bank 66 E	SYSMON Configuration	GTH Quad 226 X0Y8-X0Y11 C [RS] (RCAL)
PS DDR 504	PS MIO 501	HP I/O Bank 65 C	Configuration	GTH Quad 225 X0Y4-X0Y7 B [RS]
PS CONFIG 503	PS MIO 500	HP I/O Bank 64 D	PCIE4 X1Y0 (tandem)	GTH Quad 224 X0Y0-X0Y3 A [RS]

X15142-071417

Figure 1-38: XCZU17 and XCZU19 Banks in FFVC1760 Package and XQZU19 Banks in FFRC1760 Package

GTY Quad 134 X0Y28-X0Y31 R [L]	CMAC X0Y3	HP I/O Bank 74	HD I/O Bank 94	GTH Quad 234 X0Y40-X0Y43 K [RN]
GTY Quad 133 X0Y24-X0Y27 Q [L]	ILKN X0Y2	HP I/O Bank 73	HD I/O Bank 93	GTH Quad 233 X0Y36-X0Y39 J [RN]
GTY Quad 132 X0Y20-X0Y23 P [L]	CMAC X0Y2	HP I/O Bank 72	ILKN X1Y1	GTH Quad 232 X0Y32-X0Y35 I [RN]
GTY Quad 131 X0Y16-X0Y19 O [L]	PCIE4 X0Y3	HP I/O Bank 71 P	HD I/O Bank 91 O	GTH Quad 231 X0Y28-X0Y31 H [RN]
GTY Quad 130 X0Y12-X0Y15 N [L]	CMAC X0Y1	HP I/O Bank 70 Q	HD I/O Bank 90 N	GTH Quad 230 X0Y24-X0Y27 G [RN]
GTY Quad 129 X0Y8-X0Y11 M [L] (RCAL)	ILKN X0Y0	HP I/O Bank 69 R	ILKN X1Y0	GTH Quad 229 X0Y20-X0Y23 F [RS]
GTY Quad 128 X0Y4-X0Y7 L [L]	PCIE4 X0Y2	HP I/O Bank 68	PCIE4 X1Y2	GTH Quad 228 X0Y16-X0Y19 E [RS]
GTY Quad 127 X0Y0-X0Y3	CMAC X0Y0	HP I/O Bank 67	PCIE4 X1Y1	GTH Quad 227 X0Y12-X0Y15 D [RS]
PS GTR 505	PS MIO 502	HP I/O Bank 66 D	SYSMON Configuration	GTH Quad 226 X0Y8-X0Y11 C [RS] (RCAL)
PS DDR 504	PS MIO 501	HP I/O Bank 65 C	Configuration	GTH Quad 225 X0Y4-X0Y7 B [RS]
PS CONFIG 503	PS MIO 500	HP I/O Bank 64	PCIE4 X1Y0 (tandem)	GTH Quad 224 X0Y0-X0Y3 A [RS]

X15143-071417

Figure 1-39: XCZU17 and XCZU19 Banks in FFVD1760 Package

GTY Quad 134 X0Y28-X0Y31	CMAC X0Y3	HP I/O Bank 74 R	HD I/O Bank 94 Q	GTH Quad 234 X0Y40-X0Y43 K [RN]
GTY Quad 133 X0Y24-X0Y27	ILKN X0Y2	HP I/O Bank 73 S	HD I/O Bank 93 P	GTH Quad 233 X0Y36-X0Y39 J [RN]
GTY Quad 132 X0Y20-X0Y23	CMAC X0Y2	HP I/O Bank 72 T	ILKN X1Y1	GTH Quad 232 X0Y32-X0Y35 I [RN]
GTY Quad 131 X0Y16-X0Y19	PCIE4 X0Y3	HP I/O Bank 71 U	HD I/O Bank 91 O	GTH Quad 231 X0Y28-X0Y31 H [RN]
GTY Quad 130 X0Y12-X0Y15	CMAC X0Y1	HP I/O Bank 70 V	HD I/O Bank 90 N	GTH Quad 230 X0Y24-X0Y27 G [RN]
GTY Quad 129 X0Y8-X0Y11 (RCAL)	ILKN X0Y0	HP I/O Bank 69 W	ILKN X1Y0	GTH Quad 229 X0Y20-X0Y23 F [RS]
GTY Quad 128 X0Y4-X0Y7	PCIE4 X0Y2	HP I/O Bank 68 X	PCIE4 X1Y2	GTH Quad 228 X0Y16-X0Y19 E [RS]
GTY Quad 127 X0Y0-X0Y3	CMAC X0Y0	HP I/O Bank 67 F	PCIE4 X1Y1	GTH Quad 227 X0Y12-X0Y15 D [RS]
PS GTR 505	PS MIO 502	HP I/O Bank 66 E	SYSMON Configuration	GTH Quad 226 X0Y8-X0Y11 C [RS] (RCAL)
PS DDR 504	PS MIO 501	HP I/O Bank 65 C	Configuration	GTH Quad 225 X0Y4-X0Y7 B [RS]
PS CONFIG 503	PS MIO 500	HP I/O Bank 64 D	PCIE4 X1Y0 (tandem)	GTH Quad 224 X0Y0-X0Y3 A [RS]

X15144-071417

Figure 1-40: XCZU17 and XCZU19 Banks in FFVE1924 Package

XCZU21DR and XQZU21DR Bank Diagram Overview

GTY Quad 131 X0Y16-X0Y19	PCIE4 X0Y1	SD-FEC	HP I/O Bank 71	HD I/O Bank 91
GTY Quad 130 X0Y12-X0Y15	CMAC X0Y1	SD-FEC	HP I/O Bank 70	HD I/O Bank 90
GTY Quad 129 X0Y8-X0Y11 (RCAL)	ILKN X0Y0	SD-FEC	HP I/O Bank 69	HD I/O Bank 89
GTY Quad 128 X0Y4-X0Y7	PCIE4 X0Y0	SD-FEC	HP I/O Bank 68	HD I/O Bank 88
GTY Quad 127 X0Y0-X0Y3	CMAC X0Y0	SD-FEC	HP I/O Bank 67	HD I/O Bank 87
PS GTR 505	PS MIO 502	SD-FEC	HP I/O Bank 66	SYSMON Configuration
PS DDR 504	PS MIO 501	SD-FEC	HP I/O Bank 65	Configuration
PS CONFIG 503	PS MIO 500	SD-FEC	HP I/O Bank 64	HD I/O Bank 84

X19543-101518

Figure 1-41: XCZU21DR and XQZU21DR Banks

Bank Diagram by Package for XCZU21DR and XQZU21DR

GTY Quad 131 X0Y16-X0Y19 D [L]	PCIE4 X0Y1	SD-FEC	HP I/O Bank 71	HD I/O Bank 91
GTY Quad 130 X0Y12-X0Y15 C [L]	CMAC X0Y1	SD-FEC	HP I/O Bank 70	HD I/O Bank 90
GTY Quad 129 X0Y8-X0Y11 B [L] (RCAL)	ILKN X0Y0	SD-FEC	HP I/O Bank 69	HD I/O Bank 89 P
GTY Quad 128 X0Y4-X0Y7 A [L]	PCIE4 X0Y0	SD-FEC	HP I/O Bank 68 F	HD I/O Bank 88 O
GTY Quad 127 X0Y0-X0Y3	CMAC X0Y0	SD-FEC	HP I/O Bank 67 E	HD I/O Bank 87 N
PS GTR 505	PS MIO 502	SD-FEC	HP I/O Bank 66 D	SYSMON Configuration
PS DDR 504	PS MIO 501	SD-FEC	HP I/O Bank 65 C	Configuration
PS CONFIG 503	PS MIO 500	SD-FEC	HP I/O Bank 64	HD I/O Bank 84

X19535-081621

Figure 1-42: XCZU21DR Banks in FFVD1156 Package and XQZU21DR Banks in FFRD1156 Package

XCZU25DR Bank Diagram Overview

GTY Quad 129 X0Y8-X0Y11 (RCAL)	ILKN X0Y0	HP I/O Bank 69	HD I/O Bank 89	DAC Bank 229
GTY Quad 128 X0Y4-X0Y7	PCIE4 X0Y0	HP I/O Bank 68	HD I/O Bank 88	DAC Bank 228
GTY Quad 127 X0Y0-X0Y3	CMAC X0Y0	HP I/O Bank 67	HD I/O Bank 87	ADC Bank 227
PS GTR 505	PS MIO 502	HP I/O Bank 66	SYSMON Configuration	ADC Bank 226
PS DDR 504	PS MIO 501	HP I/O Bank 65	Configuration	ADC Bank 225
PS CONFIG 503	PS MIO 500	HP I/O Bank 64	HD I/O Bank 84	ADC Bank 224

X19546-042720

Figure 1-43: XCZU25DR Banks

Bank Diagram by Package for XCZU25DR

GTY Quad 129 X0Y8-X0Y11 B [L] (RCAL)	ILKN X0Y0	HP I/O Bank 69	HD I/O Bank 89 O	DAC Bank 229
GTY Quad 128 X0Y4-X0Y7 A [L]	PCIE4 X0Y0	HP I/O Bank 68	HD I/O Bank 88 N	DAC Bank 228
GTY Quad 127 X0Y0-X0Y3	CMAC X0Y0	HP I/O Bank 67	HD I/O Bank 87	ADC Bank 227
PS GTR 505	PS MIO 502	HP I/O Bank 66 D	SYSMON Configuration	ADC Bank 226
PS DDR 504	PS MIO 501	HP I/O Bank 65 C	Configuration	ADC Bank 225
PS CONFIG 503	PS MIO 500	HP I/O Bank 64	HD I/O Bank 84	ADC Bank 224

X19547-042720

Figure 1-44: XCZU25DR Banks in FFVE1156 and FSVE1156 Packages

GTY Quad 129 X0Y8-X0Y11 B [L] (RCAL)	ILKN X0Y0	HP I/O Bank 69 S	HD I/O Bank 89	DAC Bank 229
GTY Quad 128 X0Y4-X0Y7 A [L]	PCIE4 X0Y0	HP I/O Bank 68 R	HD I/O Bank 88	DAC Bank 228
GTY Quad 127 X0Y0-X0Y3	CMAC X0Y0	HP I/O Bank 67 Q	HD I/O Bank 87 N	ADC Bank 227
PS GTR 505	PS MIO 502	HP I/O Bank 66 D	SYSMON Configuration	ADC Bank 226
PS DDR 504	PS MIO 501	HP I/O Bank 65 C	Configuration	ADC Bank 225
PS CONFIG 503	PS MIO 500	HP I/O Bank 64 B (Partial)	HD I/O Bank 84 A	ADC Bank 224

X19548-040720

Figure 1-45: XCZU25DR Banks in FFVG1517 and FSVG1517 Packages

XCZU27DR Bank Diagram Overview

GTY Quad 131 X0Y16-X0Y19	PCIE4 X0Y1	HP I/O Bank 71	HD I/O Bank 91	
GTY Quad 130 X0Y12-X0Y15	CMAC X0Y1	HP I/O Bank 70	HD I/O Bank 90	
GTY Quad 129 X0Y8-X0Y11 (RCAL)	ILKN X0Y0	HP I/O Bank 69	HD I/O Bank 89	DAC Bank 229
GTY Quad 128 X0Y4-X0Y7	PCIE4 X0Y0	HP I/O Bank 68	HD I/O Bank 88	DAC Bank 228
GTY Quad 127 X0Y0-X0Y3	CMAC X0Y0	HP I/O Bank 67	HD I/O Bank 87	ADC Bank 227
PS GTR 505	PS MIO 502	HP I/O Bank 66	SYSMON Configuration	ADC Bank 226
PS DDR 504	PS MIO 501	HP I/O Bank 65	Configuration	ADC Bank 225
PS CONFIG 503	PS MIO 500	HP I/O Bank 64	HD I/O Bank 84	ADC Bank 224

X19549-040320

Figure 1-46: XCZU27DR Banks

Bank Diagram by Package for XCZU27DR

GTY Quad 131 X0Y16-X0Y19	PCIE4 X0Y1	HP I/O Bank 71	HD I/O Bank 91	
GTY Quad 130 X0Y12-X0Y15	CMAC X0Y1	HP I/O Bank 70	HD I/O Bank 90	
GTY Quad 129 X0Y8-X0Y11 B [L] (RCAL)	ILKN X0Y0	HP I/O Bank 69	HD I/O Bank 89 O	DAC Bank 229
GTY Quad 128 X0Y4-X0Y7 A [L]	PCIE4 X0Y0	HP I/O Bank 68	HD I/O Bank 88 N	DAC Bank 228
GTY Quad 127 X0Y0-X0Y3	CMAC X0Y0	HP I/O Bank 67	HD I/O Bank 87	ADC Bank 227
PS GTR 505	PS MIO 502	HP I/O Bank 66 D	SYSMON Configuration	ADC Bank 226
PS DDR 504	PS MIO 501	HP I/O Bank 65 C	Configuration	ADC Bank 225
PS CONFIG 503	PS MIO 500	HP I/O Bank 64	HD I/O Bank 84	ADC Bank 224

X19550-040320

Figure 1-47: XCZU27DR Banks in FFVE1156 and FSVE1156 Packages

GTY Quad 131 X0Y16-X0Y19 D [L]	PCIE4 X0Y1	HP I/O Bank 71	HD I/O Bank 91	
GTY Quad 130 X0Y12-X0Y15 C [L]	CMAC X0Y1	HP I/O Bank 70	HD I/O Bank 90	
GTY Quad 129 X0Y8-X0Y11 B [L] (RCAL)	ILKN X0Y0	HP I/O Bank 69 S	HD I/O Bank 89	DAC Bank 229
GTY Quad 128 X0Y4-X0Y7 A [L]	PCIE4 X0Y0	HP I/O Bank 68 R	HD I/O Bank 88	DAC Bank 228
GTY Quad 127 X0Y0-X0Y3	CMAC X0Y0	HP I/O Bank 67 Q	HD I/O Bank 87 N	ADC Bank 227
PS GTR 505	PS MIO 502	HP I/O Bank 66 D	SYSMON Configuration	ADC Bank 226
PS DDR 504	PS MIO 501	HP I/O Bank 65 C	Configuration	ADC Bank 225
PS CONFIG 503	PS MIO 500	HP I/O Bank 64 B (Partial)	HD I/O Bank 84 A	ADC Bank 224

X19551-040320

Figure 1-48: XCZU27DR Banks in FFVG1517 and FSVG1517 Packages

XCZU28DR and XQZU28DR Bank Diagram Overview

GTY Quad 131 X0Y16-X0Y19	PCIE4 X0Y1	SD-FEC	HP I/O Bank 71	HD I/O Bank 91	
GTY Quad 130 X0Y12-X0Y15	CMAC X0Y1	SD-FEC	HP I/O Bank 70	HD I/O Bank 90	
GTY Quad 129 X0Y8-X0Y11 (RCAL)	ILKN X0Y0	SD-FEC	HP I/O Bank 69	HD I/O Bank 89	DAC Bank 229
GTY Quad 128 X0Y4-X0Y7	PCIE4 X0Y0	SD-FEC	HP I/O Bank 68	HD I/O Bank 88	DAC Bank 228
GTY Quad 127 X0Y0-X0Y3	CMAC X0Y0	SD-FEC	HP I/O Bank 67	HD I/O Bank 87	ADC Bank 227
PS GTR 505	PS MIO 502	SD-FEC	HP I/O Bank 66	SYSMON Configuration	ADC Bank 226
PS DDR 504	PS MIO 501	SD-FEC	HP I/O Bank 65	Configuration	ADC Bank 225
PS CONFIG 503	PS MIO 500	SD-FEC	HP I/O Bank 64	HD I/O Bank 84	ADC Bank 224

X19552-040320

Figure 1-49: XCZU28DR and XQZU28DR Banks

Bank Diagram by Package for XCZU28DR and XQZU28DR

GTY Quad 131 X0Y16-X0Y19	PCIE4 X0Y1	SD-FEC	HP I/O Bank 71	HD I/O Bank 91	
GTY Quad 130 X0Y12-X0Y15	CMAC X0Y1	SD-FEC	HP I/O Bank 70	HD I/O Bank 90	
GTY Quad 129 X0Y8-X0Y11 B [L] (RCAL)	ILKN X0Y0	SD-FEC	HP I/O Bank 69	HD I/O Bank 89 O	DAC Bank 229
GTY Quad 128 X0Y4-X0Y7 A [L]	PCIE4 X0Y0	SD-FEC	HP I/O Bank 68	HD I/O Bank 88 N	DAC Bank 228
GTY Quad 127 X0Y0-X0Y3	CMAC X0Y0	SD-FEC	HP I/O Bank 67	HD I/O Bank 87	ADC Bank 227
PS GTR 505	PS MIO 502	SD-FEC	HP I/O Bank 66 D	SYSMON Configuration	ADC Bank 226
PS DDR 504	PS MIO 501	SD-FEC	HP I/O Bank 65 C	Configuration	ADC Bank 225
PS CONFIG 503	PS MIO 500	SD-FEC	HP I/O Bank 64	HD I/O Bank 84	ADC Bank 224

X19553-042720

Figure 1-50: XCZU28DR Banks in FFVE1156 and FSVE1156 Packages and XQZU28DR in FFRE1156 Package

GTU Quad 131 X0Y16-X0Y19 D [L]	PCIE4 X0Y1	SD-FEC	HP I/O Bank 71	HD I/O Bank 91	
GTU Quad 130 X0Y12-X0Y15 C [L]	CMAC X0Y1	SD-FEC	HP I/O Bank 70	HD I/O Bank 90	
GTU Quad 129 X0Y8-X0Y11 B [L] (RCAL)	ILKN X0Y0	SD-FEC	HP I/O Bank 69 S	HD I/O Bank 89	DAC Bank 229
GTU Quad 128 X0Y4-X0Y7 A [L]	PCIE4 X0Y0	SD-FEC	HP I/O Bank 68 R	HD I/O Bank 88	DAC Bank 228
GTU Quad 127 X0Y0-X0Y3	CMAC X0Y0	SD-FEC	HP I/O Bank 67 Q	HD I/O Bank 87 N	ADC Bank 227
PS GTR 505	PS MIO 502	SD-FEC	HP I/O Bank 66 D	SYSMON Configuration	ADC Bank 226
PS DDR 504	PS MIO 501	SD-FEC	HP I/O Bank 65 C	Configuration	ADC Bank 225
PS CONFIG 503	PS MIO 500	SD-FEC	HP I/O Bank 64 B (Partial)	HD I/O Bank 84 A	ADC Bank 224

X19554-042720

Figure 1-51: XCZU28DR Banks in FFVG1517 and FSVG1517 Packages and XQZU28DR in FFRG1517 Package

XCZU29DR, XQZU29DR, and XCZU39DR Bank Diagram Overview

GTY Quad 131 X0Y16-X0Y19	PCIE4 X0Y1	HP I/O Bank 71	HD I/O Bank 91	DAC Bank 231
GTY Quad 130 X0Y12-X0Y15	CMAC X0Y1	HP I/O Bank 70	HD I/O Bank 90	DAC Bank 230
GTY Quad 129 X0Y8-X0Y11 (RCAL)	ILKN X0Y0	HP I/O Bank 69	HD I/O Bank 89	DAC Bank 229
GTY Quad 128 X0Y4-X0Y7	PCIE4 X0Y0	HP I/O Bank 68	HD I/O Bank 88	DAC Bank 228
GTY Quad 127 X0Y0-X0Y3	CMAC X0Y0	HP I/O Bank 67	HD I/O Bank 87	ADC Bank 227
PS GTR 505	PS MIO 502	HP I/O Bank 66	SYSMON Configuration	ADC Bank 226
PS DDR 504	PS MIO 501	HP I/O Bank 65	Configuration	ADC Bank 225
PS CONFIG 503	PS MIO 500	HP I/O Bank 64	HD I/O Bank 84	ADC Bank 224

X19555-040620

Figure 1-52: XCZU29DR, XQZU29DR, and XCZU39DR Banks

Bank Diagram by Package for XCZU29DR, XQZU29DR, and XCZU39DR

GTY Quad 131 X0Y16-X0Y19 D [L]	PCIE4 X0Y1	HP I/O Bank 71	HD I/O Bank 91	DAC Bank 231
GTY Quad 130 X0Y12-X0Y15 C [L]	CMAC X0Y1	HP I/O Bank 70	HD I/O Bank 90	DAC Bank 230
GTY Quad 129 X0Y8-X0Y11 B [L] (RCAL)	ILKN X0Y0	HP I/O Bank 69 T	HD I/O Bank 89 P	DAC Bank 229
GTY Quad 128 X0Y4-X0Y7 A [L]	PCIE4 X0Y0	HP I/O Bank 68 S	HD I/O Bank 88 O	DAC Bank 228
GTY Quad 127 X0Y0-X0Y3	CMAC X0Y0	HP I/O Bank 67 R	HD I/O Bank 87 N	ADC Bank 227
PS GTR 505	PS MIO 502	HP I/O Bank 66 D	SYSMON Configuration	ADC Bank 226
PS DDR 504	PS MIO 501	HP I/O Bank 65 C	Configuration	ADC Bank 225
PS CONFIG 503	PS MIO 500	HP I/O Bank 64 B	HD I/O Bank 84 A	ADC Bank 224

X19556-042620

Figure 1-53: XCZU29DR and XCZU39DR Banks in FVVF1760 and FSVF1760 Packages and XQZU29DR Banks in FFRF1760 Package

XCZU42DR Bank Diagram Overview

GTY Quad 128 X0Y4-X0Y7 (RCAL)		HP I/O Bank 68	HD I/O Bank 88	DAC Bank 228
GTY Quad 127 X0Y0-X0Y3	CMAC X0Y0	HP I/O Bank 67		DAC Bank 227
PS GTR 505	PS MIO 502	HP I/O Bank 66	SYSMON Configuration	ADC Bank 226
PS DDR 504	PS MIO 501	HP I/O Bank 65	Configuration	ADC Bank 225
PS CONFIG 503	PS MIO 500	HP I/O Bank 64		ADC Bank 224

X25704-090221

Figure 1-54: XCZU42DR Banks

Bank Diagram by Package for XCZU42DR

GTY Quad 128 X0Y4-X0Y7 B [L] (RCAL)		HP I/O Bank 68	HD I/O Bank 88 O	DAC Bank 228
GTY Quad 127 X0Y0-X0Y3 A [L]	CMAC X0Y0	HP I/O Bank 67 N (Partial)		DAC Bank 227
PS GTR 505	PS MIO 502	HP I/O Bank 66 D	SYSMON Configuration	ADC Bank 226
PS DDR 504	PS MIO 501	HP I/O Bank 65 C	Configuration	ADC Bank 225
PS CONFIG 503	PS MIO 500	HP I/O Bank 64		ADC Bank 224

X25705-011422

Figure 1-55: XCZU42DR Banks in FFVE1156 and FSVE1156 Packages

XCZU43DR Bank Diagram Overview

GTY Quad 131 X0Y16-X0Y19	PCIE4 X0Y1	HP I/O Bank 71	HD I/O Bank 91	DAC Bank 231
GTY Quad 130 X0Y12-X0Y15	CMAC X0Y1	HP I/O Bank 70	HD I/O Bank 90	DAC Bank 230
GTY Quad 129 X0Y8-X0Y11 (RCAL)	ILKN X0Y0	HP I/O Bank 69	HD I/O Bank 89	DAC Bank 229
GTY Quad 128 X0Y4-X0Y7	PCIE4 X0Y0	HP I/O Bank 68	HD I/O Bank 88	DAC Bank 228
GTY Quad 127 X0Y0-X0Y3	CMAC X0Y0	HP I/O Bank 67	HD I/O Bank 87	ADC Bank 227
PS GTR 505	PS MIO 502	HP I/O Bank 66	SYSMON Configuration	ADC Bank 226
PS DDR 504	PS MIO 501	HP I/O Bank 65	Configuration	ADC Bank 225
PS CONFIG 503	PS MIO 500	HP I/O Bank 64	HD I/O Bank 84	ADC Bank 224

X23814-042620

Figure 1-56: XCZU43DR Banks

Bank Diagram by Package for XCZU43DR

GTY Quad 131 X0Y16-X0Y19	PCIE4 X0Y1	HP I/O Bank 71	HD I/O Bank 91	DAC Bank 231
GTY Quad 130 X0Y12-X0Y15	CMAC X0Y1	HP I/O Bank 70	HD I/O Bank 90	DAC Bank 230
GTY Quad 129 X0Y8-X0Y11 B [L] (RCAL)	ILKN X0Y0	HP I/O Bank 69	HD I/O Bank 89 O	DAC Bank 229
GTY Quad 128 X0Y4-X0Y7 A [L]	PCIE4 X0Y0	HP I/O Bank 68	HD I/O Bank 88 N	DAC Bank 228
GTY Quad 127 X0Y0-X0Y3	CMAC X0Y0	HP I/O Bank 67	HD I/O Bank 87	ADC Bank 227
PS GTR 505	PS MIO 502	HP I/O Bank 66 D	SYSMON Configuration	ADC Bank 226
PS DDR 504	PS MIO 501	HP I/O Bank 65 C	Configuration	ADC Bank 225
PS CONFIG 503	PS MIO 500	HP I/O Bank 64	HD I/O Bank 84	ADC Bank 224

X23816-122021

Figure 1-57: XCZU43DR Banks in FFVE1156 and FSVE1156 Packages

GTY Quad 131 X0Y16-X0Y19 D [L]	PCIE4 X0Y1	HP I/O Bank 71	HD I/O Bank 91	DAC Bank 231
GTY Quad 130 X0Y12-X0Y15 C [L]	CMAC X0Y1	HP I/O Bank 70	HD I/O Bank 90	DAC Bank 230
GTY Quad 129 X0Y8-X0Y11 B [L] (RCAL)	ILKN X0Y0	HP I/O Bank 69 S	HD I/O Bank 89	DAC Bank 229
GTY Quad 128 X0Y4-X0Y7 A [L]	PCIE4 X0Y0	HP I/O Bank 68 R	HD I/O Bank 88	DAC Bank 228
GTY Quad 127 X0Y0-X0Y3	CMAC X0Y0	HP I/O Bank 67 Q	HD I/O Bank 87 N	ADC Bank 227
PS GTR 505	PS MIO 502	HP I/O Bank 66 D	SYSMON Configuration	ADC Bank 226
PS DDR 504	PS MIO 501	HP I/O Bank 65 C	Configuration	ADC Bank 225
PS CONFIG 503	PS MIO 500	HP I/O Bank 64 B (Partial)	HD I/O Bank 84 A	ADC Bank 224

X23817-042720

Figure 1-58: XCZU43DR Banks in FFVG1517 and FSVG1517 Packages

XCZU46DR Bank Diagram Overview

GTY Quad 131 X0Y16-X0Y19	PCIE4 X0Y1	SD-FEC	HP I/O Bank 71	HD I/O Bank 91	DAC Bank 231
GTY Quad 130 X0Y12-X0Y15	CMAC X0Y1	SD-FEC	HP I/O Bank 70	HD I/O Bank 90	DAC Bank 230
GTY Quad 129 X0Y8-X0Y11 (RCAL)	ILKN X0Y0	SD-FEC	HP I/O Bank 69	HD I/O Bank 89	DAC Bank 229
GTY Quad 128 X0Y4-X0Y7	PCIE4 X0Y0	SD-FEC	HP I/O Bank 68	HD I/O Bank 88	DAC Bank 228
GTY Quad 127 X0Y0-X0Y3	CMAC X0Y0	SD-FEC	HP I/O Bank 67	HD I/O Bank 87	ADC Bank 227
PS GTR 505	PS MIO 502	SD-FEC	HP I/O Bank 66	SYSMON Configuration	ADC Bank 226
PS DDR 504	PS MIO 501	SD-FEC	HP I/O Bank 65	Configuration	ADC Bank 225
PS CONFIG 503	PS MIO 500	SD-FEC	HP I/O Bank 64	HD I/O Bank 84	ADC Bank 224

X23818-042720

Figure 1-59: XCZU46DR Banks

Bank Diagram by Package for XCZU46DR

GTY Quad 131 X0Y16-X0Y19 D [L]	PCIE4 X0Y1	SD-FEC	HP I/O Bank 71 S	HD I/O Bank 91 P	DAC Bank 231
GTY Quad 130 X0Y12-X0Y15 C [L]	CMAC X0Y1	SD-FEC	HP I/O Bank 70 T	HD I/O Bank 90 O	DAC Bank 230
GTY Quad 129 X0Y8-X0Y11 B [L] (RCAL)	ILKN X0Y0	SD-FEC	HP I/O Bank 69 R	HD I/O Bank 89	DAC Bank 229
GTY Quad 128 X0Y4-X0Y7 A [L]	PCIE4 X0Y0	SD-FEC	HP I/O Bank 68	HD I/O Bank 88	DAC Bank 228
GTY Quad 127 X0Y0-X0Y3	CMAC X0Y0	SD-FEC	HP I/O Bank 67	HD I/O Bank 87	ADC Bank 227
PS GTR 505	PS MIO 502	SD-FEC	HP I/O Bank 66 D	SYSMON Configuration	ADC Bank 226
PS DDR 504	PS MIO 501	SD-FEC	HP I/O Bank 65 C	Configuration	ADC Bank 225
PS CONFIG 503	PS MIO 500	SD-FEC	HP I/O Bank 64 B	HD I/O Bank 84	ADC Bank 224

X23819-081621

Figure 1-60: XCZU46DR Banks in FFVH1760 and FSVH1760 Packages

XCZU47DR Bank Diagram Overview

GTY Quad 131 X0Y16-X0Y19	PCIE4 X0Y1	HP I/O Bank 71	HD I/O Bank 91	DAC Bank 231
GTY Quad 130 X0Y12-X0Y15	CMAC X0Y1	HP I/O Bank 70	HD I/O Bank 90	DAC Bank 230
GTY Quad 129 X0Y8-X0Y11 (RCAL)	ILKN X0Y0	HP I/O Bank 69	HD I/O Bank 89	DAC Bank 229
GTY Quad 128 X0Y4-X0Y7	PCIE4 X0Y0	HP I/O Bank 68	HD I/O Bank 88	DAC Bank 228
GTY Quad 127 X0Y0-X0Y3	CMAC X0Y0	HP I/O Bank 67	HD I/O Bank 87	ADC Bank 227
PS GTR 505	PS MIO 502	HP I/O Bank 66	SYSMON Configuration	ADC Bank 226
PS DDR 504	PS MIO 501	HP I/O Bank 65	Configuration	ADC Bank 225
PS CONFIG 503	PS MIO 500	HP I/O Bank 64	HD I/O Bank 84	ADC Bank 224

X23820-042720

Figure 1-61: XCZU47DR Banks

Bank Diagram by Package for XCZU47DR

GTU Quad 131 X0Y16-X0Y19	PCIE4 X0Y1	HP I/O Bank 71	HD I/O Bank 91	DAC Bank 231
GTU Quad 130 X0Y12-X0Y15	CMAC X0Y1	HP I/O Bank 70	HD I/O Bank 90	DAC Bank 230
GTU Quad 129 X0Y8-X0Y11 B [L] (RCAL)	ILKN X0Y0	HP I/O Bank 69	HD I/O Bank 89 O	DAC Bank 229
GTU Quad 128 X0Y4-X0Y7 A [L]	PCIE4 X0Y0	HP I/O Bank 68	HD I/O Bank 88 N	DAC Bank 228
GTU Quad 127 X0Y0-X0Y3	CMAC X0Y0	HP I/O Bank 67	HD I/O Bank 87	ADC Bank 227
PS GTR 505	PS MIO 502	HP I/O Bank 66 D	SYSMON Configuration	ADC Bank 226
PS DDR 504	PS MIO 501	HP I/O Bank 65 C	Configuration	ADC Bank 225
PS CONFIG 503	PS MIO 500	HP I/O Bank 64	HD I/O Bank 84	ADC Bank 224

X23821-042720

Figure 1-62: XCZU47DR Banks in FFVE1156 and FSVE1156 Packages

GTY Quad 131 X0Y16-X0Y19 D [L]	PCIE4 X0Y1	HP I/O Bank 71	HD I/O Bank 91	DAC Bank 231
GTY Quad 130 X0Y12-X0Y15 C [L]	CMAC X0Y1	HP I/O Bank 70	HD I/O Bank 90	DAC Bank 230
GTY Quad 129 X0Y8-X0Y11 B [L] (RCAL)	ILKN X0Y0	HP I/O Bank 69 S	HD I/O Bank 89	DAC Bank 229
GTY Quad 128 X0Y4-X0Y7 A [L]	PCIE4 X0Y0	HP I/O Bank 68 R	HD I/O Bank 88	DAC Bank 228
GTY Quad 127 X0Y0-X0Y3	CMAC X0Y0	HP I/O Bank 67 Q	HD I/O Bank 87 N	ADC Bank 227
PS GTR 505	PS MIO 502	HP I/O Bank 66 D	SYSMON Configuration	ADC Bank 226
PS DDR 504	PS MIO 501	HP I/O Bank 65 C	Configuration	ADC Bank 225
PS CONFIG 503	PS MIO 500	HP I/O Bank 64 B (Partial)	HD I/O Bank 84 A	ADC Bank 224

X23822-042720

Figure 1-63: XCZU47DR Banks in FFVG1517 and FSVG1517 Packages

XCZU48DR Bank Diagram Overview

GTY Quad 131 X0Y16-X0Y19	PCIE4 X0Y1	SD-FEC	HP I/O Bank 71	HD I/O Bank 91	DAC Bank 231
GTY Quad 130 X0Y12-X0Y15	CMAC X0Y1	SD-FEC	HP I/O Bank 70	HD I/O Bank 90	DAC Bank 230
GTY Quad 129 X0Y8-X0Y11 (RCAL)	ILKN X0Y0	SD-FEC	HP I/O Bank 69	HD I/O Bank 89	DAC Bank 229
GTY Quad 128 X0Y4-X0Y7	PCIE4 X0Y0	SD-FEC	HP I/O Bank 68	HD I/O Bank 88	DAC Bank 228
GTY Quad 127 X0Y0-X0Y3	CMAC X0Y0	SD-FEC	HP I/O Bank 67	HD I/O Bank 87	ADC Bank 227
PS GTR 505	PS MIO 502	SD-FEC	HP I/O Bank 66	SYSMON Configuration	ADC Bank 226
PS DDR 504	PS MIO 501	SD-FEC	HP I/O Bank 65	Configuration	ADC Bank 225
PS CONFIG 503	PS MIO 500	SD-FEC	HP I/O Bank 64	HD I/O Bank 84	ADC Bank 224

X23823-042720

Figure 1-64: XCZU48DR Banks

Bank Diagram by Package for XCZU48DR

GTY Quad 131 X0Y16-X0Y19	PCIE4 X0Y1	FEC	HP I/O Bank 71	HD I/O Bank 91	DAC Bank 231
GTY Quad 130 X0Y12-X0Y15	CMAC X0Y1	FEC	HP I/O Bank 70	HD I/O Bank 90	DAC Bank 230
GTY Quad 129 X0Y8-X0Y11 B [L] (RCAL)	ILKN X0Y0	FEC	HP I/O Bank 69	HD I/O Bank 89 O	DAC Bank 229
GTY Quad 128 X0Y4-X0Y7 A [L]	PCIE4 X0Y0	FEC	HP I/O Bank 68	HD I/O Bank 88 N	DAC Bank 228
GTY Quad 127 X0Y0-X0Y3	CMAC X0Y0	FEC	HP I/O Bank 67	HD I/O Bank 87	ADC Bank 227
PS GTR 505	PS MIO 502	FEC	HP I/O Bank 66 D	SYSMON Configuration	ADC Bank 226
PS DDR 504	PS MIO 501	FEC	HP I/O Bank 65 C	Configuration	ADC Bank 225
PS CONFIG 503	PS MIO 500	FEC	HP I/O Bank 64	HD I/O Bank 84	ADC Bank 224

X23824-042720

Figure 1-65: XCZU48DR Banks in FFVE1156 and FSVE1156 Packages

GTY Quad 131 X0Y16-X0Y19 D [L]	PCIE4 X0Y1	SD-FEC	HP I/O Bank 71	HD I/O Bank 91	DAC Bank 231
GTY Quad 130 X0Y12-X0Y15 C [L]	CMAC X0Y1	SD-FEC	HP I/O Bank 70	HD I/O Bank 90	DAC Bank 230
GTY Quad 129 X0Y8-X0Y11 B [L] (RCAL)	ILKN X0Y0	SD-FEC	HP I/O Bank 69 S	HD I/O Bank 89	DAC Bank 229
GTY Quad 128 X0Y4-X0Y7 A [L]	PCIE4 X0Y0	SD-FEC	HP I/O Bank 68 R	HD I/O Bank 88	DAC Bank 228
GTY Quad 127 X0Y0-X0Y3	CMAC X0Y0	SD-FEC	HP I/O Bank 67 Q	HD I/O Bank 87 N	ADC Bank 227
PS GTR 505	PS MIO 502	SD-FEC	HP I/O Bank 66 D	SYSMON Configuration	ADC Bank 226
PS DDR 504	PS MIO 501	SD-FEC	HP I/O Bank 65 C	Configuration	ADC Bank 225
PS CONFIG 503	PS MIO 500	SD-FEC	HP I/O Bank 64 B (Partial)	HD I/O Bank 84 A	ADC Bank 224

X23825-042720

Figure 1-66: XCZU48DR Banks in FFVG1517 and FSVG1517, and XQZU48DR Banks in FSRG1517 Packages

XCZU49DR Bank Diagram Overview

GTY Quad 131 X0Y16-X0Y19	PCIE4 X0Y1	HP I/O Bank 71	HD I/O Bank 91	DAC Bank 231
GTY Quad 130 X0Y12-X0Y15	CMAC X0Y1	HP I/O Bank 70	HD I/O Bank 90	DAC Bank 230
GTY Quad 129 X0Y8-X0Y11 (RCAL)	ILKN X0Y0	HP I/O Bank 69	HD I/O Bank 89	DAC Bank 229
GTY Quad 128 X0Y4-X0Y7	PCIE4 X0Y0	HP I/O Bank 68	HD I/O Bank 88	DAC Bank 228
GTY Quad 127 X0Y0-X0Y3	CMAC X0Y0	HP I/O Bank 67	HD I/O Bank 87	ADC Bank 227
PS GTR 505	PS MIO 502	HP I/O Bank 66	SYSMON Configuration	ADC Bank 226
PS DDR 504	PS MIO 501	HP I/O Bank 65	Configuration	ADC Bank 225
PS CONFIG 503	PS MIO 500	HP I/O Bank 64	HD I/O Bank 84	ADC Bank 224

X23826-042720

Figure 1-67: XCZU49DR Banks

Bank Diagram by Package for XCZU49DR

GTY Quad 131 X0Y16-X0Y19 D [L]	PCIE4 X0Y1	HP I/O Bank 71	HD I/O Bank 91	DAC Bank 231
GTY Quad 130 X0Y12-X0Y15 C [L]	CMAC X0Y1	HP I/O Bank 70	HD I/O Bank 90	DAC Bank 230
GTY Quad 129 X0Y8-X0Y11 B [L] (RCAL)	ILKN X0Y0	HP I/O Bank 69 T	HD I/O Bank 89 P	DAC Bank 229
GTY Quad 128 X0Y4-X0Y7 A [L]	PCIE4 X0Y0	HP I/O Bank 68 S	HD I/O Bank 88 O	DAC Bank 228
GTY Quad 127 X0Y0-X0Y3	CMAC X0Y0	HP I/O Bank 67 R	HD I/O Bank 87 N	ADC Bank 227
PS GTR 505	PS MIO 502	HP I/O Bank 66 D	SYSMON Configuration	ADC Bank 226
PS DDR 504	PS MIO 501	HP I/O Bank 65 C	Configuration	ADC Bank 225
PS CONFIG 503	PS MIO 500	HP I/O Bank 64 B	HD I/O Bank 84 A	ADC Bank 224

X23815-042720

Figure 1-68: XCZU49DR Banks in FFVF1760 and FSVF1760, and XQZU49DR Banks in FSRF1760 Packages

XCZU63DR Bank Diagram Overview

GTY Quad 128 X0Y4-X0Y7 (RCAL)		HP I/O Bank 68	HD I/O Bank 88	DAC Bank 228
GTY Quad 127 X0Y0-X0Y3	CMAC X0Y0	HP I/O Bank 67		DAC Bank 227
PS GTR 505	PS MIO 502	HP I/O Bank 66	SYSMON Configuration	ADC Bank 226
PS DDR 504	PS MIO 501	HP I/O Bank 65	Configuration	ADC Bank 225
PS CONFIG 503	PS MIO 500	HP I/O Bank 64		ADC Bank 224

X28948-010524

Figure 1-69: XCZU63DR Banks

Bank Diagram by Package for XCZU63DR

GTY Quad 128 X0Y4-X0Y7 (RCAL)		HP I/O Bank 68	HD I/O Bank 88 O	DAC Bank 228
GTY Quad 127 X0Y0-X0Y3 A [L]	CMAC X0Y0	HP I/O Bank 67 N (Partial)		DAC Bank 227
PS GTR 505	PS MIO 502	HP I/O Bank 66 D	SYSMON Configuration	ADC Bank 226 (Partial)
PS DDR 504	PS MIO 501	HP I/O Bank 65 C	Configuration	ADC Bank 225
PS CONFIG 503	PS MIO 500	HP I/O Bank 64		ADC Bank 224

X28949-010524

Figure 1-70: XCZU63DR Banks in FFVE1156 and FSVE1156 Packages

XCZU64DR Bank Diagram Overview

GTY Quad 128 X0Y4-X0Y7 (RCAL)		HP I/O Bank 68	HD I/O Bank 88	DAC Bank 228
GTY Quad 127 X0Y0-X0Y3	CMAC X0Y0	HP I/O Bank 67		DAC Bank 227
PS GTR 505	PS MIO 502	HP I/O Bank 66	SYSMON Configuration	ADC Bank 226
PS DDR 504	PS MIO 501	HP I/O Bank 65	Configuration	ADC Bank 225
PS CONFIG 503	PS MIO 500	HP I/O Bank 64		ADC Bank 224

X28951-010524

Figure 1-71: XCZU64DR Banks

Bank Diagram by Package for XCZU64DR

GTY Quad 128 X0Y4-X0Y7 B [L] (RCAL)		HP I/O Bank 68	HD I/O Bank 88 O	DAC Bank 228
GTY Quad 127 X0Y0-X0Y3 A [L]	CMAC X0Y0	HP I/O Bank 67 N (Partial)		DAC Bank 227
PS GTR 505	PS MIO 502	HP I/O Bank 66 D	SYSMON Configuration	ADC Bank 226 (Partial)
PS DDR 504	PS MIO 501	HP I/O Bank 65 C	Configuration	ADC Bank 225
PS CONFIG 503	PS MIO 500	HP I/O Bank 64		ADC Bank 224

X28950-010524

Figure 1-72: XCZU64DR Banks in FFVE1156 and FSVE1156 Packages

XCZU65DR Bank Diagram Overview

GTY Quad 128 X0Y4-X0Y7 (RCAL)		HP I/O Bank 68	HD I/O Bank 88	DAC Bank 228
GTY Quad 127 X0Y0-X0Y3	CMAC X0Y0	HP I/O Bank 67		DAC Bank 227
PS GTR 505	PS MIO 502	HP I/O Bank 66	SYSMON Configuration	ADC Bank 226
PS DDR 504	PS MIO 501	HP I/O Bank 65	Configuration	ADC Bank 225
PS CONFIG 503	PS MIO 500	HP I/O Bank 64		ADC Bank 224

X25706-090221

Figure 1-73: XCZU65DR Banks

Bank Diagram by Package for XCZU65DR

GTY Quad 128 X0Y4-X0Y7 B [L] (RCAL)		HP I/O Bank 68	HD I/O Bank 88 O	DAC Bank 228
GTY Quad 127 X0Y0-X0Y3 A [L]	CMAC X0Y0	HP I/O Bank 67 N (Partial)		DAC Bank 227
PS GTR 505	PS MIO 502	HP I/O Bank 66 D	SYSMON Configuration	ADC Bank 226
PS DDR 504	PS MIO 501	HP I/O Bank 65 C	Configuration	ADC Bank 225
PS CONFIG 503	PS MIO 500	HP I/O Bank 64		ADC Bank 224

X25707-011322

Figure 1-74: XCZU65DR Banks in FFVE1156 and FSVE1156 Packages

XCZU67DR Bank Diagram Overview

GTY Quad 128 X0Y4-X0Y7 (RCAL)		HP I/O Bank 68	HD I/O Bank 88	DAC Bank 228
GTY Quad 127 X0Y0-X0Y3	CMAC X0Y0	HP I/O Bank 67		DAC Bank 227
PS GTR 505	PS MIO 502	HP I/O Bank 66	SYSMON Configuration	ADC Bank 226
PS DDR 504	PS MIO 501	HP I/O Bank 65	Configuration	ADC Bank 225
PS CONFIG 503	PS MIO 500	HP I/O Bank 64		ADC Bank 224

X25708-090221

Figure 1-75: XCZU67DR Banks

Bank Diagram by Package for XCZU67DR

GTY Quad 128 X0Y4-X0Y7 B [L] (RCAL)		HP I/O Bank 68	HD I/O Bank 88 O	DAC Bank 228
GTY Quad 127 X0Y0-X0Y3 A [L]	CMAC X0Y0	HP I/O Bank 67 N (Partial)		DAC Bank 227
PS GTR 505	PS MIO 502	HP I/O Bank 66 D	SYSMON Configuration	ADC Bank 226
PS DDR 504	PS MIO 501	HP I/O Bank 65 C	Configuration	ADC Bank 225
PS CONFIG 503	PS MIO 500	HP I/O Bank 64		ADC Bank 224

X25709-011322

Figure 1-76: XCZU67DR Banks in FFVE1156 and FSVE1156 Packages

PS Memory Interface Pin Guidelines

Introduction to PS Memory Interface Pins

This chapter shows what is needed to support the broad requirements of various memory interfaces using the Zynq™ UltraScale+™ device DDR subsystem. It covers DDR3/3L, DDR4, LPDDR4, and LPDDR3.



IMPORTANT: *SBVA484 and SFVA625 packages only support 32-bit data buses for the PS DDR controller. The Zynq UltraScale+ device DDR subsystem can only be configured for 32-bit or 32-bit plus ECC DDR3/DDR4/LPDDR3 designs when using these packages.*



IMPORTANT: *For the devices in the SBVA484, UBVA454, and UBVA530 packages, the HP I/Os in bank 66 are powered by VCCO_65.*

DDR3/3L Guidelines

DDR3/3L Pin Rules

The DDR3/3L pin rules are for single and dual-rank memory interfaces.

- All unused DDR pins can be left unconnected. For example, in a 64-bit interface without ECC, the PS_DDR_DQ64 to PS_DDR_DQ71, PS_DDR_DQS_P8/N8, and PS_DDR_DM8 pins can be left unconnected.
- Connect the PS_DDR_ZQ pin to GND using a 240Ω resistor. There should be separate 240Ω resistors at the MPSoC or RFSoc and at the DRAM.

DDR3/3L Pin Swapping Restrictions

- Address/command/control bits cannot be swapped.
- DQ byte lane swapping is allowed. A byte lane includes any signals associated with the aligned 8-bits of DQ, such as DM, DQS, DQS_N, and DQ signals.
- DQ bits swapping within a byte lane is allowed.

DDR3/3L Pinout Example for Supported Configurations

Table 2-1 shows a pinout example for the DDR3/3L supported configurations. For termination details, see the *UltraScale Architecture PCB Design Guide (UG583)*. When not being used for a memory interface, all pins should be left unconnected with the exception of VCCO_PSDDR and VCC_PSDDR_PLL, which should be tied to GND.



IMPORTANT: *VCC_PSINTFP must be tied to VCC_PSINTFP_DDR. This requirement is in Zynq UltraScale+ MPSoC Data Sheet: DC and AC Switching Characteristics (DS925) and Zynq UltraScale+ RFSoc Data Sheet: DC and AC Switching Characteristics (DS926), where both VCC_PSINTFP and VCC_PSINTFP_DDR must be connected to the same supply and thus both must be powered to avoid MBIST failure.*

Table 2-1: DDR3/3L Supported Pinout Configurations

Pin Name	DDR3/3L 64-bit 1Rank	DDR3/3L 64-bit 2Rank	DDR3/3L 32-bit 1Rank	DDR3/3L 32-bit 2Rank
VCCO_PSDDR ⁽¹⁾	Set to 1.5V (1.35V for DDR3L)	Set to 1.5V (1.35V for DDR3L)	Set to 1.5V (1.35V for DDR3L)	Set to 1.5V (1.35V for DDR3L)
PS_DDR_A0 to PS_DDR_A15	Connect A0 to PS_DDR_A0, A1 to PS_DDR_A1, and so on.	Connect A0 to PS_DDR_A0, A1 to PS_DDR_A1, and so on.	Connect A0 to PS_DDR_A0, A1 to PS_DDR_A1, and so on.	Connect A0 to PS_DDR_A0, A1 to PS_DDR_A1, and so on.
PS_DDR_A16	WE#	WE#	WE#	WE#
PS_DDR_A17	CAS#	CAS#	CAS#	CAS#
PS_DDR_ACT_N	RAS#	RAS#	RAS#	RAS#
PS_DDR_ALERT_N	Can be left unconnected.	Can be left unconnected.	Can be left unconnected.	Can be left unconnected.
PS_DDR_BA0	BA[0]	BA[0]	BA[0]	BA[0]
PS_DDR_BA1	BA[1]	BA[1]	BA[1]	BA[1]
PS_DDR_BG0	BA[2]	BA[2]	BA[2]	BA[2]
PS_DDR_BG1	Can be left unconnected.	Can be left unconnected.	Can be left unconnected.	Can be left unconnected.
PS_DDR_CK_N0	CK#	CK#[0]	CK#	CK#[0]
PS_DDR_CK_N1	Can be left unconnected.	CK#[1]	Can be left unconnected.	CK#[1]
PS_DDR_CK0	CK.	CK[0]	CK.	CK[0]
PS_DDR_CK1	Can be left unconnected.	CK[1]	Can be left unconnected.	CK[1]
PS_DDR_CKE0	CKE	CKE[0]	CKE	CKE[0]
PS_DDR_CKE1	Can be left unconnected.	CKE[1]	Can be left unconnected.	CKE[1]
PS_DDR_CS_N0	CS#	CS#[0]	CS#	CS#[0]

Table 2-1: DDR3/3L Supported Pinout Configurations (Cont'd)

Pin Name	DDR3/3L 64-bit 1Rank	DDR3/3L 64-bit 2Rank	DDR3/3L 32-bit 1Rank	DDR3/3L 32-bit 2Rank
PS_DDR_CS_N1	Can be left unconnected.	CS#[1]	Can be left unconnected.	CS#[1]
PS_DDR_DM0 to PS_DDR_DM3	Connect DM0 to PS_DDR_DM0, DM1 to PS_DDR_DM1, and so on.	Connect DM0 to PS_DDR_DM0, DM1 to PS_DDR_DM1, and so on.	Connect DM0 to PS_DDR_DM0, DM1 to PS_DDR_DM1, and so on.	Connect DM0 to PS_DDR_DM0, DM1 to PS_DDR_DM1, and so on.
PS_DDR_DM4 to PS_DDR_DM7	Connect DM4 to PS_DDR_DM4, DM5 to PS_DDR_DM5, and so on.	Connect DM4 to PS_DDR_DM4, DM5 to PS_DDR_DM5, and so on.	Can be left unconnected.	Can be left unconnected.
PS_DDR_DM8	DM8, can be left unconnected without ECC.	DM8, can be left unconnected without ECC.	DM4, can be left unconnected without ECC.	DM4, can be left unconnected without ECC.
PS_DDR_DQ0 to PS_DDR_DQ31	Connect DQ0 to PS_DDR_DQ0, DQ1 to PS_DDR_DQ1, and so on.	Connect DQ0 to PS_DDR_DQ0, DQ1 to PS_DDR_DQ1, and so on.	Connect DQ0 to PS_DDR_DQ0, DQ1 to PS_DDR_DQ1, and so on.	Connect DQ0 to PS_DDR_DQ0, DQ1 to PS_DDR_DQ1, and so on.
PS_DDR_DQ32 to PS_DDR_DQ63	Connect DQ32 to PS_DDR_DQ32, DQ33 to PS_DDR_DQ33, and so on.	Connect DQ32 to PS_DDR_DQ32, DQ33 to PS_DDR_DQ33, and so on.	Can be left unconnected.	Can be left unconnected.
PS_DDR_DQ64	ECC_bit[0], can be left unconnected without ECC.	ECC_bit[0], can be left unconnected without ECC.	ECC_bit[0], can be left unconnected without ECC.	ECC_bit[0], can be left unconnected without ECC.
PS_DDR_DQ65	ECC_bit[1], can be left unconnected without ECC.	ECC_bit[1], can be left unconnected without ECC.	ECC_bit[1], can be left unconnected without ECC.	ECC_bit[1], can be left unconnected without ECC.
PS_DDR_DQ66	ECC_bit[2], can be left unconnected without ECC.	ECC_bit[2], can be left unconnected without ECC.	ECC_bit[2], can be left unconnected without ECC.	ECC_bit[2], can be left unconnected without ECC.
PS_DDR_DQ67	ECC_bit[3], can be left unconnected without ECC.	ECC_bit[3], can be left unconnected without ECC.	ECC_bit[3], can be left unconnected without ECC.	ECC_bit[3], can be left unconnected without ECC.
PS_DDR_DQ68	ECC_bit[4], can be left unconnected without ECC.	ECC_bit[4], can be left unconnected without ECC.	ECC_bit[4], can be left unconnected without ECC.	ECC_bit[4], can be left unconnected without ECC.
PS_DDR_DQ69	ECC_bit[5], can be left unconnected without ECC.	ECC_bit[5], can be left unconnected without ECC.	ECC_bit[5], can be left unconnected without ECC.	ECC_bit[5], can be left unconnected without ECC.
PS_DDR_DQ70	ECC_bit[6], can be left unconnected without ECC.	ECC_bit[6], can be left unconnected without ECC.	ECC_bit[6], can be left unconnected without ECC.	ECC_bit[6], can be left unconnected without ECC.

Table 2-1: DDR3/3L Supported Pinout Configurations (Cont'd)

Pin Name	DDR3/3L 64-bit 1Rank	DDR3/3L 64-bit 2Rank	DDR3/3L 32-bit 1Rank	DDR3/3L 32-bit 2Rank
PS_DDR_DQ71	ECC_bit[7], can be left unconnected without ECC.	ECC_bit[7], can be left unconnected without ECC.	ECC_bit[7], can be left unconnected without ECC.	ECC_bit[7], can be left unconnected without ECC.
PS_DDR_DQS_N0 to PS_DDR_DQS_N3	Connect DQS#0 to PS_DDR_DQS_N0, DQS#1 to PS_DDR_DQS_N1, and so on.	Connect DQS#0 to PS_DDR_DQS_N0, DQS#1 to PS_DDR_DQS_N1, and so on.	Connect DQS#0 to PS_DDR_DQS_N0, DQS#1 to PS_DDR_DQS_N1, and so on.	Connect DQS#0 to PS_DDR_DQS_N0, DQS#1 to PS_DDR_DQS_N1, and so on.
PS_DDR_DQS_N4 to PS_DDR_DQS_N7	Connect DQS#4 to PS_DDR_DQS_N4, DQS#5 to PS_DDR_DQS_N5, and so on.	Connect DQS#4 to PS_DDR_DQS_N4, DQS#5 to PS_DDR_DQS_N5, and so on.	Can be left unconnected.	Can be left unconnected.
PS_DDR_DQS_N8	DQS#8, can be left unconnected without ECC.	DQS#8, can be left unconnected without ECC.	DQS#4, can be left unconnected without ECC.	DQS#4, can be left unconnected without ECC.
PS_DDR_DQS_P0 to PS_DDR_DQS_P3	Connect DQS0 to PS_DDR_DQS_P0, DQS1 to PS_DDR_DQS_P1, and so on.	Connect DQS0 to PS_DDR_DQS_P0, DQS1 to PS_DDR_DQS_P1, and so on.	Connect DQS0 to PS_DDR_DQS_P0, DQS1 to PS_DDR_DQS_P1, and so on.	Connect DQS0 to PS_DDR_DQS_P0, DQS1 to PS_DDR_DQS_P1, and so on.
PS_DDR_DQS_P4 to PS_DDR_DQS_P7	Connect DQS4 to PS_DDR_DQS_P4, DQS5 to PS_DDR_DQS_P5, and so on.	Connect DQS4 to PS_DDR_DQS_P4, DQS5 to PS_DDR_DQS_P5, and so on.	Can be left unconnected.	Can be left unconnected.
PS_DDR_DQS_P8	DQS8, can be left unconnected without ECC.	DQS8, can be left unconnected without ECC.	DQS4, can be left unconnected without ECC.	DQS4, can be left unconnected without ECC.
PS_DDR_ODT0	ODT	ODT[0]	ODT	ODT[0]
PS_DDR_ODT1	Can be left unconnected.	ODT[1]	Can be left unconnected.	ODT[1]
PS_DDR_PARITY	Par_In for RDIMMs. Can be left unconnected for components and UDIMMs.	Par_In for RDIMMs. Can be left unconnected for components and UDIMMs.	Par_In for RDIMMs. Can be left unconnected for components and UDIMMs.	Par_In for RDIMMs. Can be left unconnected for components and UDIMMs.
PS_DDR_RAM_RST_N	RESET#	RESET#	RESET#	RESET#
PS_DDR_ZQ	Connect a 240Ω resistor to GND. ⁽²⁾	Connect a 240Ω resistor to GND. ⁽²⁾	Connect a 240Ω resistor to GND. ⁽²⁾	Connect a 240Ω resistor to GND. ⁽²⁾

Notes:

1. For VCCO_PSDDR decoupling guidelines, see the *UltraScale Architecture PCB Design Guide (UG583)*.
2. There should be separate 240Ω resistors at the FPGA and at the DRAM.

DDR4 Guidelines

DDR4 Pin Rules

The DDR4 pin rules are for single and dual-rank memory interfaces.

- All unused DDR pins can be left unconnected. For example, in a 64-bit interface without ECC, the PS_DDR_DQ64 to PS_DDR_DQ71, PS_DDR_DQS_P8/N8, and PS_DDR_DM8 pins can be left unconnected.
- The PS_DDR_ALERT_N can be left floating at the DRAM. For component interfaces, connect the PS_DDR_ALERT_N pin to the ALERT_N pins of the DDR4 devices in fly-by routing, and terminate to V_{DD} with a 50Ω pull-up resistor. For DIMM designs, connect the PS_DDR_ALERT_N pin to the ALERT_N pin of the connector.
- Connect the PS_DDR_ZQ pin to GND using a 240Ω resistor. There should be separate 240Ω resistors at the FPGA and at the DRAM.
- Component interfaces with the same component for all components in the interface. The x16 components have a different number of bank groups than the x8 components. For example, create a 72-bit wide component interface by using nine x8 components or five x16 components, where half of one component is not used. Creating four x16 components and one x8 component is not permissible.

DDR4 Pin Swapping Restrictions

- Address/command/control bits cannot be swapped.
- DQ byte lane swapping is allowed. A byte lane includes any signals associated with the aligned 8-bits of DQ, such as DM, DQS, DQS_N, and DQ signals.
- DQ bits swapping within a byte lane is allowed.

DDR4 Pinout Example for Supported Configurations

Table 2-2 shows a pinout example for the DDR4 supported configurations. For termination details, see details, see the *UltraScale Architecture PCB Design Guide (UG583)*. When not being used for a memory be left unconnected with the exception of VCCO_PSDDR and VCC_PSDDR_PLL, which should be tied to



IMPORTANT: *VCC_PSINTFP must be tied to VCC_PSINTFP_DDR. This requirement is in his requirement is in Zynq Sheet: DC and AC Switching Characteristics (DS925) and Zynq UltraScale+ RFSoC Data Sheet: DC and AC Switching where both VCC_PSINTFP and VCC_PSINTFP_DDR must be connected to the same supply and thus both must be failure.*

Table 2-2: DDR4 Supported Pinout Configurations

Pin Name	DDR4 64-bit 1Rank	DDR4 64-bit 2Rank	DDR4 32-bit 1Rank	DDR4 32-bit 2Rank	DDR4 16-bit 1Rank
VCCO_PSDDR ⁽¹⁾	Set to 1.2V.	Set to 1.2V.	Set to 1.2V.	Set to 1.2V.	Set to 1.2V.
PS_DDR_A0 to PS_DDR_A16	Connect A0 to PS_DDR_A0, A1 to PS_DDR_A1, and so on. WE_N can be shared with PS_DDR_A14, CAS_N can be shared with PS_DDR_A15, and RAS_N can be shared with PS_DDR_A16.	Connect A0 to PS_DDR_A0, A1 to PS_DDR_A1, and so on. WE_N can be shared with PS_DDR_A14, CAS_N can be shared with PS_DDR_A15, and RAS_N can be shared with PS_DDR_A16.	Connect A0 to PS_DDR_A0, A1 to PS_DDR_A1, and so on. WE_N can be shared with PS_DDR_A14, CAS_N can be shared with PS_DDR_A15, and RAS_N can be shared with PS_DDR_A16.	Connect A0 to PS_DDR_A0, A1 to PS_DDR_A1, and so on. WE_N can be shared with PS_DDR_A14, CAS_N can be shared with PS_DDR_A15, and RAS_N can be shared with PS_DDR_A16.	Connect A0 to PS_DDR_A0, A1 to PS_DDR_A1, and so on. WE_N can be shared with PS_DDR_A14, CAS_N can be shared with PS_DDR_A15, and RAS_N can be shared with PS_DDR_A16.
PS_DDR_A17	Can be left unconnected	Can be left unconnected	Can be left unconnected	Can be left unconnected	Can be left unconnected
PS_DDR_ACT_N	ACT_n	ACT_n	ACT_n	ACT_n	ACT_n
PS_DDR_ALERT_N	ALERT_n	ALERT_n	ALERT_n	ALERT_n	ALERT_n
PS_DDR_BA0	BA[0]	BA[0]	BA[0]	BA[0]	BA[0]
PS_DDR_BA1	BA[1]	BA[1]	BA[1]	BA[1]	BA[1]

Table 2-2: DDR4 Supported Pinout Configurations (Cont'd)

Pin Name	DDR4 64-bit 1Rank	DDR4 64-bit 2Rank	DDR4 32-bit 1Rank	DDR4 32-bit 2Rank	DDR4 16-bit 1Rank
PS_DDR_BG0	BG[0]	BG[0]	BG[0]	BG[0]	BG[0]
PS_DDR_BG1(2)	BG[1]	BG[1]	BG[1]	BG[1]	BG[1]
PS_DDR_CK_N0	CK_c[0]	CK_c[0]	CK_c[0]	CK_c[0]	CK_c[0]
PS_DDR_CK_N1	Can be left unconnected.	CK_c[1]	Can be left unconnected.	CK_c[1]	Can be left unconnected.
PS_DDR_CK0	CK_t[0]	CK_t[0]	CK_t[0]	CK_t[0]	CK_t[0]
PS_DDR_CK1	Can be left unconnected.	CK_t[1]	Can be left unconnected.	CK_t[1]	Can be left unconnected.
PS_DDR_CKE0	CKE	CKE[0]	CKE	CKE[0]	CKE
PS_DDR_CKE1	Can be left unconnected.	CKE[1]	Can be left unconnected.	CKE[1]	Can be left unconnected.
PS_DDR_CS_N0	CS_n	CS_n[0]	CS_n	CS_n[0]	CS_n
PS_DDR_CS_N1	Can be left unconnected.	CS_n[1]	Can be left unconnected.	CS_n[1]	Can be left unconnected.
PS_DDR_DM0 to PS_DDR_DM1	Connect DM_n[0]/DBI_n[0] to PS_DDR_DM0, DM_n[1]/DBI_n[1] to PS_DDR_DM1, and so on.	Connect DM_n[0]/DBI_n[0] to PS_DDR_DM0, DM_n[1]/DBI_n[1] to PS_DDR_DM1, and so on.	Connect DM_n[0]/DBI_n[0] to PS_DDR_DM0, DM_n[1]/DBI_n[1] to PS_DDR_DM1, and so on.	Connect DM_n[0]/DBI_n[0] to PS_DDR_DM0, DM_n[1]/DBI_n[1] to PS_DDR_DM1, and so on.	Connect DM_n[0]/DBI_n[0] to PS_DDR_DM0, DM_n[1]/DBI_n[1] to PS_DDR_DM1, and so on.
PS_DDR_DM2 to PS_DDR_DM3	Connect DM_n[2]/DBI_n[2] to PS_DDR_DM2, DM_n[3]/DBI_n[3] to PS_DDR_DM3, and so on.	Connect DM_n[2]/DBI_n[2] to PS_DDR_DM2, DM_n[3]/DBI_n[3] to PS_DDR_DM3, and so on.	Connect DM_n[2]/DBI_n[2] to PS_DDR_DM2, DM_n[3]/DBI_n[3] to PS_DDR_DM3, and so on.	Connect DM_n[2]/DBI_n[2] to PS_DDR_DM2, DM_n[3]/DBI_n[3] to PS_DDR_DM3, and so on.	Connect DM_n[2]/DBI_n[2] to PS_DDR_DM2, DM_n[3]/DBI_n[3] to PS_DDR_DM3, and so on.

Table 2-2: DDR4 Supported Pinout Configurations (Cont'd)

Pin Name	DDR4 64-bit 1Rank	DDR4 64-bit 2Rank	DDR4 32-bit 1Rank	DDR4 32-bit 2Rank	DDR4 16-bit 1Rank
PS_DDR_DM4 to PS_DDR_DM7	Connect DM_n[4]/DBI_n[4] to PS_DDR_DM4, DM_n[5]/DBI_n[5] to PS_DDR_DM5, and so on.	Connect DM_n[4]/DBI_n[4] to PS_DDR_DM4, DM_n[5]/DBI_n[5] to PS_DDR_DM5, and so on.	Can be left unconnected.	Can be left unconnected.	Can be left unconnected.
PS_DDR_DM8	DM_n[8]/DBI_n[8], can be left unconnected without ECC.	DM_n[8]/DBI_n[8], can be left unconnected without ECC.	DM_n[4]/DBI_n[4], can be left unconnected without ECC.	DM_n[4]/DBI_n[4], can be left unconnected without ECC.	DM_n[2]/DBI_n[2] can be left unconnected without ECC.
PS_DDR_DQ0 to PS_DDR_DQ15	Connect DQ0 to PS_DDR_DQ0, DQ1 to PS_DDR_DQ1, and so on.	Connect DQ0 to PS_DDR_DQ0, DQ1 to PS_DDR_DQ1, and so on.	Connect DQ0 to PS_DDR_DQ0, DQ1 to PS_DDR_DQ1, and so on.	Connect DQ0 to PS_DDR_DQ0, DQ1 to PS_DDR_DQ1, and so on.	Connect DQ0 to PS_DDR_DQ0, to PS_DDR_DQ1, and so on.
PS_DDR_DQ16 to PS_DDR_DQ31	Connect DQ16 to PS_DDR_DQ16, DQ17 to PS_DDR_DQ17, and so on.	Connect DQ16 to PS_DDR_DQ16, DQ17 to PS_DDR_DQ17, and so on.	Connect DQ16 to PS_DDR_DQ16, DQ17 to PS_DDR_DQ17, and so on.	Connect DQ16 to PS_DDR_DQ16, DQ17 to PS_DDR_DQ17, and so on.	Can be left unconnected. Do not swap with PS_DDR_DQ0 to PS_DDR_DQ15
PS_DDR_DQ32 to PS_DDR_DQ63	Connect DQ32 to PS_DDR_DQ32, DQ33 to PS_DDR_DQ33, and so on.	Connect DQ32 to PS_DDR_DQ32, DQ33 to PS_DDR_DQ33, and so on.	Can be left unconnected. Do not swap with PS_DDR_DQ0 to PS_DDR_DQ31.	Can be left unconnected. Do not swap with PS_DDR_DQ0 to PS_DDR_DQ31.	Can be left unconnected. Do not swap with PS_DDR_DQ0 to PS_DDR_DQ31
PS_DDR_DQ64	ECC_bit[0], can be left unconnected without ECC.	ECC_bit[0], can be left unconnected without ECC.	ECC_bit[0], can be left unconnected without ECC.	ECC_bit[0], can be left unconnected without ECC.	ECC_bit[0], can be left unconnected without ECC.
PS_DDR_DQ65	ECC_bit[1], can be left unconnected without ECC.	ECC_bit[1], can be left unconnected without ECC.	ECC_bit[1], can be left unconnected without ECC.	ECC_bit[1], can be left unconnected without ECC.	ECC_bit[1], can be left unconnected without ECC.

Table 2-2: DDR4 Supported Pinout Configurations (Cont'd)

Pin Name	DDR4 64-bit 1Rank	DDR4 64-bit 2Rank	DDR4 32-bit 1Rank	DDR4 32-bit 2Rank	DDR4 16-bit 1Rank
PS_DDR_DQ66	ECC_bit[2], can be left unconnected without ECC.	ECC_bit[2], can be left unconnected without ECC.	ECC_bit[2], can be left unconnected without ECC.	ECC_bit[2], can be left unconnected without ECC.	ECC_bit[2], can be left unconnected without ECC.
PS_DDR_DQ67	ECC_bit[3], can be left unconnected without ECC.	ECC_bit[3], can be left unconnected without ECC.	ECC_bit[3], can be left unconnected without ECC.	ECC_bit[3], can be left unconnected without ECC.	ECC_bit[3], can be left unconnected without ECC.
PS_DDR_DQ68	ECC_bit[4], can be left unconnected without ECC.	ECC_bit[4], can be left unconnected without ECC.	ECC_bit[4], can be left unconnected without ECC.	ECC_bit[4], can be left unconnected without ECC.	ECC_bit[4], can be left unconnected without ECC.
PS_DDR_DQ69	ECC_bit[5], can be left unconnected without ECC.	ECC_bit[5], can be left unconnected without ECC.	ECC_bit[5], can be left unconnected without ECC.	ECC_bit[5], can be left unconnected without ECC.	ECC_bit[5], can be left unconnected without ECC.
PS_DDR_DQ70	ECC_bit[6], can be left unconnected without ECC.	ECC_bit[6], can be left unconnected without ECC.	ECC_bit[6], can be left unconnected without ECC.	ECC_bit[6], can be left unconnected without ECC.	ECC_bit[6], can be left unconnected without ECC.
PS_DDR_DQ71	ECC_bit[7], can be left unconnected without ECC.	ECC_bit[7], can be left unconnected without ECC.	ECC_bit[7], can be left unconnected without ECC.	ECC_bit[7], can be left unconnected without ECC.	ECC_bit[7], can be left unconnected without ECC.
PS_DDR_DQS_N0 to PS_DDR_DQS_N1	Connect DQS_c0 to PS_DDR_DQS_N0, DQS_c1 to PS_DDR_DQS_N1, and so on.	Connect DQS_c0 to PS_DDR_DQS_N0, DQS_c1 to PS_DDR_DQS_N1, and so on.	Connect DQS_c0 to PS_DDR_DQS_N0, DQS_c1 to PS_DDR_DQS_N1, and so on.	Connect DQS_c0 to PS_DDR_DQS_N0, DQS_c1 to PS_DDR_DQS_N1, and so on.	Connect DQS_c0 to PS_DDR_DQS_N0, DQS_c1 to PS_DDR_DQS_N1, and so on.
PS_DDR_DQS_N2 to PS_DDR_DQS_N3	Connect DQS_c2 to PS_DDR_DQS_N2, DQS_c3 to PS_DDR_DQS_N3, and so on.	Connect DQS_c2 to PS_DDR_DQS_N2, DQS_c3 to PS_DDR_DQS_N3, and so on.	Connect DQS_c2 to PS_DDR_DQS_N2, DQS_c3 to PS_DDR_DQS_N3, and so on.	Connect DQS_c2 to PS_DDR_DQS_N2, DQS_c3 to PS_DDR_DQS_N3, and so on.	Connect DQS_c2 to PS_DDR_DQS_N2, DQS_c3 to PS_DDR_DQS_N3, and so on.



Table 2-2: DDR4 Supported Pinout Configurations (Cont'd)

Pin Name	DDR4 64-bit 1Rank	DDR4 64-bit 2Rank	DDR4 32-bit 1Rank	DDR4 32-bit 2Rank	DDR4 16-bit 1Rank
PS_DDR_DQS_N4 to PS_DDR_DQS_N7	Connect DQS_c4 to PS_DDR_DQS_N4, DQS_c5 to PS_DDR_DQS_N5, and so on.	Connect DQS_c4 to PS_DDR_DQS_N4, DQS_c5 to PS_DDR_DQS_N5, and so on.	Can be left unconnected.	Can be left unconnected.	Can be left unconnected.
PS_DDR_DQS_N8	DQS_c8, can be left unconnected without ECC.	DQS_c8, can be left unconnected without ECC.	DQS_c4, can be left unconnected without ECC.	DQS_c4, can be left unconnected without ECC.	DQS_c2, can be left unconnected without ECC.
PS_DDR_DQS_P0 to PS_DDR_DQS_P1	Connect DQS_t0 to PS_DDR_DQS_P0, DQS_t1 to PS_DDR_DQS_P1, and so on.	Connect DQS_t0 to PS_DDR_DQS_P0, DQS_t1 to PS_DDR_DQS_P1, and so on.	Connect DQS_t0 to PS_DDR_DQS_P0, DQS_t1 to PS_DDR_DQS_P1, and so on.	Connect DQS_t0 to PS_DDR_DQS_P0, DQS_t1 to PS_DDR_DQS_P1, and so on.	Connect DQS_t0 to PS_DDR_DQS_P0, DQS_t1 to PS_DDR_DQS_P1, and so on.
PS_DDR_DQS_P2 to PS_DDR_DQS_P3	Connect DQS_t2 to PS_DDR_DQS_P2, DQS_t3 to PS_DDR_DQS_P3, and so on.	Connect DQS_t2 to PS_DDR_DQS_P2, DQS_t3 to PS_DDR_DQS_P3, and so on.	Connect DQS_t2 to PS_DDR_DQS_P2, DQS_t3 to PS_DDR_DQS_P3, and so on.	Connect DQS_t2 to PS_DDR_DQS_P2, DQS_t3 to PS_DDR_DQS_P3, and so on.	Can be left unconnected.
PS_DDR_DQS_P4 to PS_DDR_DQS_P7	Connect DQS_t4 to PS_DDR_DQS_P4, DQS_t5 to PS_DDR_DQS_P5, and so on.	Connect DQS_t4 to PS_DDR_DQS_P4, DQS_t5 to PS_DDR_DQS_P5, and so on.	Can be left unconnected.	Can be left unconnected.	Can be left unconnected.
PS_DDR_DQS_P8	DQS_t8, can be left unconnected without ECC.	DQS_t8, can be left unconnected without ECC.	DQS_t4, can be left unconnected without ECC.	DQS_t4, can be left unconnected without ECC.	DQS_t2, can be left unconnected without ECC.
PS_DDR_ODT0	ODT	ODT[0]	ODT	ODT[0]	ODT
PS_DDR_ODT1	Can be left unconnected.	ODT[1]	Can be left unconnected.	ODT[1]	Can be left unconnected.
PS_DDR_PARITY	PAR	PAR	PAR	PAR	PAR
PS_DDR_RAM_RST_N	RESET_n	RESET_n	RESET_n	RESET_n	RESET_n

Table 2-2: DDR4 Supported Pinout Configurations (Cont'd)

Pin Name	DDR4 64-bit 1Rank	DDR4 64-bit 2Rank	DDR4 32-bit 1Rank	DDR4 32-bit 2Rank	DDR4 16-bit 1Rank
PS_DDR_ZQ	Connect to GND through a 240Ω resistor. Connect DRAM ZQ pins to VSSQ through a 240Ω resistor.	Connect to GND through a 240Ω resistor. Connect DRAM ZQ pins to VSSQ through a 240Ω resistor.	Connect to GND through a 240Ω resistor. Connect DRAM ZQ pins to VSSQ through a 240Ω resistor.	Connect to GND through a 240Ω resistor. Connect DRAM ZQ pins to VSSQ through a 240Ω resistor.	Connect to GND through a 240Ω resistor. Connect DRAM ZQ pins to VSSQ through a 240Ω resistor.

Notes:

1. For VCCO_PSDDR decoupling guidelines, see the *UltraScale Architecture PCB Design Guide* ([UG583](#)).
2. The PS_DDR_BG1 pin can be left unconnected when targeting x16 component interfaces without a BG1 pin, but it should always be connected.

LPDDR4 Guidelines

LPDDR4 Pin Rules

The LPDDR4 pin rules are for single and dual-rank memory interfaces.

- All unused DDR pins can be left unconnected. For example, in an 64-bit interface without ECC, the PS_DDR_DQ64 to PS_DDR_DQ71, PS_DDR_DQS_P8/N8, and PS_DDR_DM8 pins can be left unconnected.
- Connect the PS_DDR_ZQ pin to GND using a 240Ω resistor. There should be separate 240Ω resistors at the FPGA and at the DRAM.
- To achieve maximum performance, address copy mode is suggested.

LPDDR4 Pin Swapping Restrictions

- Command/address bits cannot be swapped.
- To support write DQS to DQ training, DQ byte lane swapping is not allowed.
- To support write DQS to DQ training, DQ bits with bytes 0, 2, and 8 are not allowed to be swapped.
- Bits within bytes 1 and 3 can be swapped.

LPDDR4 Pinout Example for Supported Configurations

Table 2-3 shows a pinout example for the LPDDR4 supported configurations. For termination details, see the *UltraScale Architecture PCB Design Guide (UG583)*. When not being used for a memory interface, all pins should be left unconnected with the exception of VCCO_PSDDR and VCC_PSDDR_PLL, which should be tied to GND.



IMPORTANT: *VCC_PSINTFP must be tied to VCC_PSINTFP_DDR. This requirement is in Zynq UltraScale+ MPSoC Data Sheet: DC and AC Switching Characteristics (DS925) and Zynq UltraScale+ RFSoc Data Sheet: DC and AC Switching Characteristics (DS926), where both VCC_PSINTFP and VCC_PSINTFP_DDR must be connected to the same supply and thus both must be powered to avoid MBIST failure.*

Table 2-3: LPDDR4 Supported Pinout Configurations

Pin Name	LPDDR4 32-bit 1Rank	LPDDR4 32-bit 1Rank ECC	LPDDR4 32-bit 2Rank	LPDDR4 32-bit 2Rank ECC
VCCO_PSDDR ⁽¹⁾	Set to 1.1V	Set to 1.1V	Set to 1.1V	Set to 1.1V
PS_DDR_A0	CA0_A	CA0_A	CA0_A	CA0_A
PS_DDR_A1	CA1_A	CA1_A	CA1_A	CA1_A
PS_DDR_A2	CA2_A	CA2_A	CA2_A	CA2_A

Table 2-3: LPDDR4 Supported Pinout Configurations (Cont'd)

Pin Name	LPDDR4 32-bit 1Rank	LPDDR4 32-bit 1Rank ECC	LPDDR4 32-bit 2Rank	LPDDR4 32-bit 2Rank ECC
PS_DDR_A3	CA3_A	CA3_A	CA3_A	CA3_A
PS_DDR_A4	CA4_A	CA4_A	CA4_A	CA4_A
PS_DDR_A5	CA5_A	CA5_A	CA5_A	CA5_A
PS_DDR_A6 to PS_DDR_A9	Can be left unconnected.	Can be left unconnected.	Can be left unconnected.	Can be left unconnected.
PS_DDR_A10	CA0_B	CA0_B	CA0_B	CA0_B
PS_DDR_A11	CA1_B	CA1_B	CA1_B	CA1_B
PS_DDR_A12	CA2_B	CA2_B	CA2_B	CA2_B
PS_DDR_A13	CA3_B	CA3_B	CA3_B	CA3_B
PS_DDR_A14	CA4_B	CA4_B	CA4_B	CA4_B
PS_DDR_A15	CA5_B	CA5_B	CA5_B	CA5_B
PS_DDR_A16	Can be left unconnected.	Can be left unconnected.	Can be left unconnected.	Can be left unconnected.
PS_DDR_A17	Can be left unconnected.	Can be left unconnected.	Can be left unconnected.	Can be left unconnected.
PS_DDR_ACT_N	Can be left unconnected.	Can be left unconnected.	Can be left unconnected.	Can be left unconnected.
PS_DDR_ALERT_N	Can be left unconnected.	Can be left unconnected.	Can be left unconnected.	Can be left unconnected.
PS_DDR_BA0	Can be left unconnected.	Can be left unconnected.	Can be left unconnected.	Can be left unconnected.
PS_DDR_BA1	Can be left unconnected.	Can be left unconnected.	Can be left unconnected.	Can be left unconnected.
PS_DDR_BG0	Can be left unconnected.	Can be left unconnected.	Can be left unconnected.	Can be left unconnected.
PS_DDR_BG1	Can be left unconnected.	Can be left unconnected.	Can be left unconnected.	Can be left unconnected.
PS_DDR_CK_N0	CK_c_A	CK_c_A	CK_c_A	CK_c_A
PS_DDR_CK_N1	CK_c_B	CK_c_B	CK_c_B	CK_c_B
PS_DDR_CK0	CK_t_A	CK_t_A	CK_t_A	CK_t_A
PS_DDR_CK1	CK_t_B	CK_t_B	CK_t_B	CK_t_B
PS_DDR_CKE0	CKE_A and CKE_B	CKE_A	CKE0_A and CKE0_B	CKE0_A
PS_DDR_CKE1	Can be left unconnected.	Can be left unconnected.	CKE1_A and CKE1_B	CKE1_A
PS_DDR_CS_N0	CS_A and CS_B	CS_A	CS0_A and CS0_B	CS0_A
PS_DDR_CS_N1	Can be left unconnected.	Can be left unconnected.	CS1_A and CS1_B	CS1_A
PS_DDR_DM0	DMI0_A	DMI0_A	DMI0_A	DMI0_A

Table 2-3: LPDDR4 Supported Pinout Configurations (Cont'd)

Pin Name	LPDDR4 32-bit 1Rank	LPDDR4 32-bit 1Rank ECC	LPDDR4 32-bit 2Rank	LPDDR4 32-bit 2Rank ECC
PS_DDR_DM1	DMI1_A	DMI1_A	DMI1_A	DMI1_A
PS_DDR_DM2	DMI0_B	DMI0_B	DMI0_B	DMI0_B
PS_DDR_DM3	DMI1_B	DMI1_B	DMI1_B	DMI1_B
PS_DDR_DM4 to PS_DDR_DM7	Can be left unconnected.	Can be left unconnected.	Can be left unconnected.	Can be left unconnected.
PS_DDR_DM8	Can be left unconnected.	DMI_ECC	Can be left unconnected.	DMI_ECC
PS_DDR_DQ0 to PS_DDR_DQ15	Connect DQ0_A to PS_DDR_DQ0, DQ1_A to PS_DDR_DQ1, and so on.	Connect DQ0_A to PS_DDR_DQ0, DQ1_A to PS_DDR_DQ1, and so on.	Connect DQ0_A to PS_DDR_DQ0, DQ1_A to PS_DDR_DQ1, and so on.	Connect DQ0_A to PS_DDR_DQ0, DQ1_A to PS_DDR_DQ1, and so on.
PS_DDR_DQ16 to PS_DDR_DQ31	Connect DQ0_B to PS_DDR_DQ16, DQ1_B to PS_DDR_DQ17, and so on.	Connect DQ0_B to PS_DDR_DQ16, DQ1_B to PS_DDR_DQ17, and so on.	Connect DQ0_B to PS_DDR_DQ16, DQ1_B to PS_DDR_DQ17, and so on.	Connect DQ0_B to PS_DDR_DQ16, DQ1_B to PS_DDR_DQ17, and so on.
PS_DDR_DQ32 to PS_DDR_DQ63	Can be left unconnected.	Can be left unconnected.	Can be left unconnected.	Can be left unconnected.
PS_DDR_DQ64	Can be left unconnected.	DQ_ECC0 (ECC_bit[0])	Can be left unconnected.	DQ_ECC0 (ECC_bit[0])
PS_DDR_DQ65	Can be left unconnected.	DQ_ECC1 (ECC_bit[1])	Can be left unconnected.	DQ_ECC1 (ECC_bit[1])
PS_DDR_DQ66	Can be left unconnected.	DQ_ECC2 (ECC_bit[2])	Can be left unconnected.	DQ_ECC2 (ECC_bit[2])
PS_DDR_DQ67	Can be left unconnected.	DQ_ECC3 (ECC_bit[3])	Can be left unconnected.	DQ_ECC3 (ECC_bit[3])
PS_DDR_DQ68	Can be left unconnected.	DQ_ECC4 (ECC_bit[4])	Can be left unconnected.	DQ_ECC4 (ECC_bit[4])
PS_DDR_DQ69	Can be left unconnected.	DQ_ECC5 (ECC_bit[5])	Can be left unconnected.	DQ_ECC5 (ECC_bit[5])
PS_DDR_DQ70	Can be left unconnected.	DQ_ECC6 (ECC_bit[6])	Can be left unconnected.	DQ_ECC6 (ECC_bit[6])
PS_DDR_DQ71	Can be left unconnected.	DQ_ECC7 (ECC_bit[7])	Can be left unconnected.	DQ_ECC7 (ECC_bit[7])
PS_DDR_DQS_N0	DQS0_c_A	DQS0_c_A	DQS0_c_A	DQS0_c_A
PS_DDR_DQS_N1	DQS1_c_A	DQS1_c_A	DQS1_c_A	DQS1_c_A
PS_DDR_DQS_N2	DQS0_c_B	DQS0_c_B	DQS0_c_B	DQS0_c_B
PS_DDR_DQS_N3	DQS1_c_B	DQS1_c_B	DQS1_c_B	DQS1_c_B
PS_DDR_DQS_N4 to PS_DDR_DQS_N7	Can be left unconnected.	Can be left unconnected.	Can be left unconnected.	Can be left unconnected.

Table 2-3: LPDDR4 Supported Pinout Configurations (Cont'd)

Pin Name	LPDDR4 32-bit 1Rank	LPDDR4 32-bit 1Rank ECC	LPDDR4 32-bit 2Rank	LPDDR4 32-bit 2Rank ECC
PS_DDR_DQS_N8	Can be left unconnected.	DQS_c_ECC	Can be left unconnected.	DQS_c_ECC
PS_DDR_DQS_P0	DQS0_t_A	DQS0_t_A	DQS0_t_A	DQS0_t_A
PS_DDR_DQS_P1	DQS1_t_A	DQS1_t_A	DQS1_t_A	DQS1_t_A
PS_DDR_DQS_P2	DQS0_t_B	DQS0_t_B	DQS0_t_B	DQS0_t_B
PS_DDR_DQS_P3	DQS1_t_B	DQS1_t_B	DQS1_t_B	DQS1_t_B
PS_DDR_DQS_P4 to PS_DDR_DQS_P7	Can be left unconnected.	Can be left unconnected.	Can be left unconnected.	Can be left unconnected.
PS_DDR_DQS_P8	Can be left unconnected.	DQS_t_ECC	Can be left unconnected.	DQS_t_ECC
PS_DDR_ODT0	Unconnected at FPGA.	Unconnected at FPGA.	Unconnected at FPGA.	Unconnected at FPGA.
PS_DDR_ODT1	Can be left unconnected.	Can be left unconnected.	Can be left unconnected.	Can be left unconnected.
PS_DDR_PARITY	Can be left unconnected.	Can be left unconnected.	Can be left unconnected.	Can be left unconnected.
PS_DDR_RAM_RST_N	RESET_n	RESET_n	RESET_n	RESET_n
PS_DDR_ZQ	Connect to GND through a 240Ω resistor. Connect DRAM ZQ pins to VDDQ through a 240Ω resistor.	Connect to GND through a 240Ω resistor. Connect DRAM ZQ pins to VDDQ through a 240Ω resistor.	Connect to GND through a 240Ω resistor. Connect DRAM ZQ pins to VDDQ through a 240Ω resistor.	Connect to GND through a 240Ω resistor. Connect DRAM ZQ pins to VDDQ through a 240Ω resistor.

Notes:

1. For VCCO_PSDDR decoupling guidelines, see the *UltraScale Architecture PCB Design Guide (UG583)*.

LPDDR3 Guidelines

LPDDR3 Pin Rules

The LPDDR3 pin rules are for single and dual-rank memory interfaces.

- All unused DDR pins can be left unconnected. For example, in an 64-bit interface without ECC, the PS_DDR_DQ64 to PS_DDR_DQ71, PS_DDR_DQS_P8/N8, and PS_DDR_DM8 pins can be left unconnected.
- Connect the PS_DDR_ZQ pin to GND using a 240Ω resistor. There should be separate 240Ω resistors at the FPGA and at the DRAM.
- To achieve maximum performance, address copy mode is suggested.

LPDDR3 Pin Swapping Restrictions

- Command/address bits cannot be swapped.
- To support command/address training, DQ byte lane swapping is not allowed.
- To support command/address training, DQ bits swapping within a byte lane is not allowed.

LPDDR3 Pinout Example for Supported Configurations

Table 2-4 shows a pinout example for the LPDDR3 supported configurations. For termination details, see the *UltraScale Architecture PCB Design Guide (UG583)*. When not being used for a memory interface, all pins should be left unconnected with the exception of VCCO_PSDDR and VCC_PSDDR_PLL, which should be tied to GND.



IMPORTANT: VCC_PSINTFP must be tied to VCC_PSINTFP_DDR. This requirement is in Zynq UltraScale+ MPSoC Data Sheet: DC and AC Switching Characteristics (DS925) and Zynq UltraScale+ RFSoc Data Sheet: DC and AC Switching Characteristics (DS926), where both VCC_PSINTFP and VCC_PSINTFP_DDR must be connected to the same supply and thus both must be powered to avoid MBIST failure.

Table 2-4: LPDDR3 Supported Pinout Configurations

Pin Name	LPDDR3 64-bit	LPDDR3 64-bit (Dual Rank)	LPDDR3 32-bit (Dual Rank)
VCCO_PSDDR ⁽¹⁾	Set to 1.2V	Set to 1.2V	Set to 1.2V
PS_DDR_A0	CA0_A	CA0_A	CA0
PS_DDR_A1	CA1_A	CA1_A	CA1
PS_DDR_A2	CA2_A	CA2_A	CA2
PS_DDR_A3	CA3_A	CA3_A	CA3

Table 2-4: LPDDR3 Supported Pinout Configurations (Cont'd)

Pin Name	LPDDR3 64-bit	LPDDR3 64-bit (Dual Rank)	LPDDR3 32-bit (Dual Rank)
PS_DDR_A4	CA4_A	CA4_A	CA4
PS_DDR_A5	CA5_A	CA5_A	CA5
PS_DDR_A6	CA6_A	CA6_A	CA6
PS_DDR_A7	CA7_A	CA7_A	CA7
PS_DDR_A8	CA8_A	CA8_A	CA8
PS_DDR_A9	CA9_A	CA9_A	CA9
PS_DDR_A10	CA0_B	CA0_B	Can be left unconnected.
PS_DDR_A11	CA1_B	CA1_B	Can be left unconnected.
PS_DDR_A12	CA2_B	CA2_B	Can be left unconnected.
PS_DDR_A13	CA3_B	CA3_B	Can be left unconnected.
PS_DDR_A14	CA4_B	CA4_B	Can be left unconnected.
PS_DDR_A15	CA5_B	CA5_B	Can be left unconnected.
PS_DDR_A16	Can be left unconnected.	Can be left unconnected.	Can be left unconnected.
PS_DDR_A17	Can be left unconnected.	Can be left unconnected.	Can be left unconnected.
PS_DDR_ACT_N	CA9_B	CA9_B	Can be left unconnected.
PS_DDR_ALERT_N	Can be left unconnected.	Can be left unconnected.	Can be left unconnected.
PS_DDR_BA0	CA6_B	CA6_B	Can be left unconnected.
PS_DDR_BA1	CA7_B	CA7_B	Can be left unconnected.
PS_DDR_BG0	CA8_B	CA8_B	Can be left unconnected.
PS_DDR_BG1	Can be left unconnected.	Can be left unconnected.	Can be left unconnected.
PS_DDR_CK_N0	CK_c_A	CK_c_A	CK_c
PS_DDR_CK_N1	CK_c_B	CK_c_B	Can be left unconnected.
PS_DDR_CK0	CK_t_A	CK_t_A	CK_t
PS_DDR_CK1	CK_t_B	CK_t_B	Can be left unconnected.
PS_DDR_CKE0	CKE_A and CKE_B	CKE0_A and CKE0_B	CKE0
PS_DDR_CKE1	Can be left unconnected.	CKE1_A and CKE1_B	CKE1
PS_DDR_CS_N0	CS_n_A and CS_n_B	CS0_n_A and CS0_n_B	CS0_n
PS_DDR_CS_N1	Can be left unconnected.	CS1_n_A and CS1_n_B	CS1_n
PS_DDR_DM0	DM0_A	DM0_A	DM0
PS_DDR_DM1	DM1_A	DM1_A	DM1
PS_DDR_DM2	DM2_A	DM2_A	DM2
PS_DDR_DM3	DM3_A	DM3_A	DM3
PS_DDR_DM4	DM0_B	DM0_B	Can be left unconnected.
PS_DDR_DM5	DM1_B	DM1_B	Can be left unconnected.

Table 2-4: LPDDR3 Supported Pinout Configurations (Cont'd)

Pin Name	LPDDR3 64-bit	LPDDR3 64-bit (Dual Rank)	LPDDR3 32-bit (Dual Rank)
PS_DDR_DM6	DM2_B	DM2_B	Can be left unconnected.
PS_DDR_DM7	DM3_B	DM3_B	Can be left unconnected.
PS_DDR_DM8	DM_ECC, can be left unconnected without ECC.	DM_ECC, can be left unconnected without ECC.	DM_ECC, can be left unconnected without ECC.
PS_DDR_DQ0	DQ0_A	DQ0_A	DQ0
PS_DDR_DQ1	DQ1_A	DQ1_A	DQ1
PS_DDR_DQ2	DQ2_A	DQ2_A	DQ2
PS_DDR_DQ3	DQ3_A	DQ3_A	DQ3
PS_DDR_DQ4	DQ4_A	DQ4_A	DQ4
PS_DDR_DQ5	DQ5_A	DQ5_A	DQ5
PS_DDR_DQ6	DQ6_A	DQ6_A	DQ6
PS_DDR_DQ7	DQ7_A	DQ7_A	DQ7
PS_DDR_DQ8	DQ8_A	DQ8_A	DQ8
PS_DDR_DQ9	DQ9_A	DQ9_A	DQ9
PS_DDR_DQ10	DQ10_A	DQ10_A	DQ10
PS_DDR_DQ11	DQ11_A	DQ11_A	DQ11
PS_DDR_DQ12	DQ12_A	DQ12_A	DQ12
PS_DDR_DQ13	DQ13_A	DQ13_A	DQ13
PS_DDR_DQ14	DQ14_A	DQ14_A	DQ14
PS_DDR_DQ15	DQ15_A	DQ15_A	DQ15
PS_DDR_DQ16	DQ16_A	DQ16_A	DQ16
PS_DDR_DQ17	DQ17_A	DQ17_A	DQ17
PS_DDR_DQ18	DQ18_A	DQ18_A	DQ18
PS_DDR_DQ19	DQ19_A	DQ19_A	DQ19
PS_DDR_DQ20	DQ20_A	DQ20_A	DQ20
PS_DDR_DQ21	DQ21_A	DQ21_A	DQ21
PS_DDR_DQ22	DQ22_A	DQ22_A	DQ22
PS_DDR_DQ23	DQ23_A	DQ23_A	DQ23
PS_DDR_DQ24	DQ24_A	DQ24_A	DQ24
PS_DDR_DQ25	DQ25_A	DQ25_A	DQ25
PS_DDR_DQ26	DQ26_A	DQ26_A	DQ26
PS_DDR_DQ27	DQ27_A	DQ27_A	DQ27
PS_DDR_DQ28	DQ28_A	DQ28_A	DQ28
PS_DDR_DQ29	DQ29_A	DQ29_A	DQ29

Table 2-4: LPDDR3 Supported Pinout Configurations (Cont'd)

Pin Name	LPDDR3 64-bit	LPDDR3 64-bit (Dual Rank)	LPDDR3 32-bit (Dual Rank)
PS_DDR_DQ30	DQ30_A	DQ30_A	DQ30
PS_DDR_DQ31	DQ31_A	DQ31_A	DQ31
PS_DDR_DQ32	DQ0_B	DQ0_B	Can be left unconnected.
PS_DDR_DQ33	DQ1_B	DQ1_B	Can be left unconnected.
PS_DDR_DQ34	DQ2_B	DQ2_B	Can be left unconnected.
PS_DDR_DQ35	DQ3_B	DQ3_B	Can be left unconnected.
PS_DDR_DQ36	DQ4_B	DQ4_B	Can be left unconnected.
PS_DDR_DQ37	DQ5_B	DQ5_B	Can be left unconnected.
PS_DDR_DQ38	DQ6_B	DQ6_B	Can be left unconnected.
PS_DDR_DQ39	DQ7_B	DQ7_B	Can be left unconnected.
PS_DDR_DQ40	DQ8_B	DQ8_B	Can be left unconnected.
PS_DDR_DQ41	DQ9_B	DQ9_B	Can be left unconnected.
PS_DDR_DQ42	DQ10_B	DQ10_B	Can be left unconnected.
PS_DDR_DQ43	DQ11_B	DQ11_B	Can be left unconnected.
PS_DDR_DQ44	DQ12_B	DQ12_B	Can be left unconnected.
PS_DDR_DQ45	DQ13_B	DQ13_B	Can be left unconnected.
PS_DDR_DQ46	DQ14_B	DQ14_B	Can be left unconnected.
PS_DDR_DQ47	DQ15_B	DQ15_B	Can be left unconnected.
PS_DDR_DQ48	DQ16_B	DQ16_B	Can be left unconnected.
PS_DDR_DQ49	DQ17_B	DQ17_B	Can be left unconnected.
PS_DDR_DQ50	DQ18_B	DQ18_B	Can be left unconnected.
PS_DDR_DQ51	DQ19_B	DQ19_B	Can be left unconnected.
PS_DDR_DQ52	DQ20_B	DQ20_B	Can be left unconnected.
PS_DDR_DQ53	DQ21_B	DQ21_B	Can be left unconnected.
PS_DDR_DQ54	DQ22_B	DQ22_B	Can be left unconnected.
PS_DDR_DQ55	DQ23_B	DQ23_B	Can be left unconnected.
PS_DDR_DQ56	DQ24_B	DQ24_B	Can be left unconnected.
PS_DDR_DQ57	DQ25_B	DQ25_B	Can be left unconnected.
PS_DDR_DQ58	DQ26_B	DQ26_B	Can be left unconnected.
PS_DDR_DQ59	DQ27_B	DQ27_B	Can be left unconnected.
PS_DDR_DQ60	DQ28_B	DQ28_B	Can be left unconnected.
PS_DDR_DQ61	DQ29_B	DQ29_B	Can be left unconnected.
PS_DDR_DQ62	DQ30_B	DQ30_B	Can be left unconnected.
PS_DDR_DQ63	DQ31_B	DQ31_B	Can be left unconnected.

Table 2-4: LPDDR3 Supported Pinout Configurations (Cont'd)

Pin Name	LPDDR3 64-bit	LPDDR3 64-bit (Dual Rank)	LPDDR3 32-bit (Dual Rank)
PS_DDR_DQ64	DQ_ECC0 (ECC_bit[0]), can be left unconnected without ECC.	DQ_ECC0 (ECC_bit[0]), can be left unconnected without ECC.	DQ_ECC0 (ECC_bit[0]), can be left unconnected without ECC.
PS_DDR_DQ65	DQ_ECC1 (ECC_bit[1]), can be left unconnected without ECC.	DQ_ECC1 (ECC_bit[1]), can be left unconnected without ECC.	DQ_ECC1 (ECC_bit[1]), can be left unconnected without ECC.
PS_DDR_DQ66	DQ_ECC2 (ECC_bit[2]), can be left unconnected without ECC.	DQ_ECC2 (ECC_bit[2]), can be left unconnected without ECC.	DQ_ECC2 (ECC_bit[2]), can be left unconnected without ECC.
PS_DDR_DQ67	DQ_ECC3 (ECC_bit[3]), can be left unconnected without ECC.	DQ_ECC3 (ECC_bit[3]), can be left unconnected without ECC.	DQ_ECC3 (ECC_bit[3]), can be left unconnected without ECC.
PS_DDR_DQ68	DQ_ECC4 (ECC_bit[4]), can be left unconnected without ECC.	DQ_ECC4 (ECC_bit[4]), can be left unconnected without ECC.	DQ_ECC4 (ECC_bit[4]), can be left unconnected without ECC.
PS_DDR_DQ69	DQ_ECC5 (ECC_bit[5]), can be left unconnected without ECC.	DQ_ECC5 (ECC_bit[5]), can be left unconnected without ECC.	DQ_ECC5 (ECC_bit[5]), can be left unconnected without ECC.
PS_DDR_DQ70	DQ_ECC6 (ECC_bit[6]), can be left unconnected without ECC.	DQ_ECC6 (ECC_bit[6]), can be left unconnected without ECC.	DQ_ECC6 (ECC_bit[6]), can be left unconnected without ECC.
PS_DDR_DQ71	DQ_ECC7 (ECC_bit[7]), can be left unconnected without ECC.	DQ_ECC7 (ECC_bit[7]), can be left unconnected without ECC.	DQ_ECC7 (ECC_bit[7]), can be left unconnected without ECC.
PS_DDR_DQS_N0	DQS0_c_A	DQS0_c_A	DQS0_c
PS_DDR_DQS_N1	DQS1_c_A	DQS1_c_A	DQS1_c
PS_DDR_DQS_N2	DQS2_c_A	DQS2_c_A	DQS2_c
PS_DDR_DQS_N3	DQS3_c_A	DQS3_c_A	DQS3_c
PS_DDR_DQS_N4	DQS0_c_B	DQS0_c_B	Can be left unconnected.
PS_DDR_DQS_N5	DQS1_c_B	DQS1_c_B	Can be left unconnected.
PS_DDR_DQS_N6	DQS2_c_B	DQS2_c_B	Can be left unconnected.
PS_DDR_DQS_N7	DQS3_c_B	DQS3_c_B	Can be left unconnected.
PS_DDR_DQS_N8	DQS_c_ECC, can be left unconnected without ECC.	DQS_c_ECC, can be left unconnected without ECC.	DQS_c_ECC, can be left unconnected without ECC.
PS_DDR_DQS_P0	DQS0_t_A	DQS0_t_A	DQS0_t
PS_DDR_DQS_P1	DQS1_t_A	DQS1_t_A	DQS1_t
PS_DDR_DQS_P2	DQS2_t_A	DQS2_t_A	DQS2_t
PS_DDR_DQS_P3	DQS3_t_A	DQS3_t_A	DQS3_t
PS_DDR_DQS_P4	DQS0_t_B	DQS0_t_B	Can be left unconnected.
PS_DDR_DQS_P5	DQS1_t_B	DQS1_t_B	Can be left unconnected.

Table 2-4: LPDDR3 Supported Pinout Configurations (Cont'd)

Pin Name	LPDDR3 64-bit	LPDDR3 64-bit (Dual Rank)	LPDDR3 32-bit (Dual Rank)
PS_DDR_DQS_P6	DQS2_t_B	DQS2_t_B	Can be left unconnected.
PS_DDR_DQS_P7	DQS3_t_B	DQS3_t_B	Can be left unconnected.
PS_DDR_DQS_P8	DQS_t_ECC, can be left unconnected without ECC.	DQS_t_ECC, can be left unconnected without ECC.	DQS_t_ECC, can be left unconnected without ECC.
PS_DDR_ODT0	ODT_A and ODT_B	ODT_A and ODT_B	ODT
PS_DDR_ODT1	Can be left unconnected.	Can be left unconnected.	Can be left unconnected.
PS_DDR_PARITY	Can be left unconnected.	Can be left unconnected.	Can be left unconnected.
PS_DDR_RAM_RST_N	Can be left unconnected.	Can be left unconnected.	Can be left unconnected.
PS_DDR_ZQ	Connect a 240Ω resistor to GND. ⁽²⁾	Connect a 240Ω resistor to GND. ⁽²⁾	Connect a 240Ω resistor to GND. ⁽²⁾

Notes:

1. For VCCO_PSDDR decoupling guidelines, see the *UltraScale Architecture PCB Design Guide* (UG583).
2. There should be separate 240Ω resistors at the FPGA and at the DRAM.

Package Files

About ASCII Package Files

The ASCII package files for each Zynq™ UltraScale+™ device include a comma-separated-values (CSV) version and a text version optimized for a browser or text editor in fixed-width fonts. The information in each of the files includes:

- Device/Package name (*family-device-package*), with date and time of creation
- Six columns containing data for each pin:
 - Pin—Pin location on the package.
 - Pin Name—The name of the assigned pin.
 - Memory Byte Group—Memory byte group between 0 and 3 split into upper (U) and lower (L) halves. For more information on the memory byte group, see the *UltraScale Architecture-Based Memory Interface Solutions Product Guide* (PG150).
 - Bank—Bank number.
 - I/O Type—CONFIG, HD, HP, GTH, GTY, PS-GTR, PSMIO, PSDDR, or PSCONFIG depends on the I/O type. For more information on the I/O type, see the *UltraScale Architecture SelectIO Resources User Guide* (UG571).
 - Super Logic Region—Number corresponding to the super logic region (SLR) in the devices implemented with stacked silicon interconnect (SSI) technology.
- Total number of pins in the package.

Package Specifications Designations

Package specifications are designated as evaluation only, engineering sample, or production. Each designation is defined as follows.

Evaluation Only

These package specifications are based on initial device specifications, package routability analysis and mechanical package construction. Package specifications with this designation are not stable and package pinouts are likely to change and these specifications should only be used for initial system level design feasibility.

Engineering Sample

These package specifications are based on a released package design and validated with ES engineering sample (ES) devices. Package specifications with this designation are considered stable, however some pinout and mechanical specifications might change prior to the production release of the particular device. Package pinouts with this designation are to be used for PCB and Vivado™ designs using ES devices.

Production

These package specifications are released coincident with production release of a particular device. Customers receive formal notification of any subsequent changes.

ASCII Pinout Files

Links to the ASCII pinout information device/package combinations are listed in [Table 3-1](#).

Download all available package/device/pinout files at:

www.xilinx.com/support/package-pinout-files/zynq-ultrascale-plus-pkgs.html

Note: All package files are ASCII files in TXT and CSV file format. Only the available files listed in [Table 3-1](#) are linked and consolidated in this ZIP file:

www.xilinx.com/support/packagefiles/zuppackages/zupall.zip



IMPORTANT: All non-InFO packages are available with eutectic BGA balls. To order these packages, the device type starts with an XQ vs. XC or XA, and the Pb-free signifier in the package name is Q.

Table 3-1: Package/Device Pinout Files for CG, EG, and EV Devices

Packages	Footprint Compatible Devices					
SBVA484	XCZU1CG	XCZU2CG	XCZU3CG			
	XCZU1EG	XCZU2EG	XCZU3EG			
	XAZU1EG	XAZU2EG	XAZU3EG			
	Production	Production	Production			
SFRA484	XQZU3EG Production					
UBVA494	XCZU1CG					
	XCZU1EG Production					
UBVA530	XCZU2CG	XCZU3CG				
	XCZU2EG Production	XCZU3EG Production				
SFVA625	XCZU1CG	XCZU2CG	XCZU3CG			
	XCZU1EG	XCZU2EG	XCZU3EG			
	XAZU1EG	XAZU2EG	XAZU3EG			
	Production	Production	Production			
SFVC784	XCZU1CG	XCZU2CG	XCZU3CG	XCZU3TCG	XCZU4CG	XCZU5CG
	XCZU1EG	XCZU2EG	XCZU3EG	XCZU3TEG	XCZU4EG	XCZU5EG
	XAZU1EG	XAZU2EG	XAZU3EG	Engineering Sample	XCZU4EV	XCZU5EV
	Production	Production	Production		XAZU4EV Production	XAZU5EV Production
SFRC784	XQZU3EG Production	XQZU5EV Production				
SFVD784	XCZU3TCG XCZU3TEG Engineering Sample					
SFVE784 ⁽³⁾	XCZU4CG XCZU4EG XCZU4EV Production	XCZU5CG XCZU5EG XCZU5EV Production				
FBVB900	XCZU4CG	XCZU5CG	XCZU7CG	XAZU7EV Production		
	XCZU4EG	XCZU5EG	XCZU7EG			
	XCZU4EV	XCZU5EV	XCZU7EV			
	Production	Production	Production			
FFRB900	XQZU5EV Production	XQZU7EV Production				

Table 3-1: Package/Device Pinout Files for CG, EG, and EV Devices (Cont'd)

Packages	Footprint Compatible Devices			
FFVC900	XCZU6CG XCZU6EG Production	XCZU9CG XCZU9EG Production	XCZU15EG Production	
FFRC900	XQZU9EG Production	XQZU15EG Production		
FFVB1156	XCZU6CG XCZU6EG Production	XCZU9CG XCZU9EG Production	XCZU15EG Production	
FFRB1156	XQZU9EG Production	XQZU15EG Production		
FFVC1156	XCZU7CG XCZU7EG XCZU7EV Production	XCZU11EG Production		
FFRC1156	XQZU7EV Production	XQZU11EG Production		
FFVB1517	XCZU11EG Production	XCZU17EG Production	XCZU19EG Production	
FFRB1517	XCZU19EG Production			
FFVF1517	XCZU7CG XCZU7EG XCZU7EV Production	XCZU11EG Production	XAZU11EG Production	
FFVC1760	XCZU11EG Production	XCZU17EG Production	XCZU19EG Production	
FFRC1760	XQZU11EG Production	XQZU19EG Production		
FFVD1760	XCZU17EG Production	XCZU19EG Production		
FFVE1924	XCZU17EG Production	XCZU19EG Production		



Table 3-2: Package/Device Pinout Files for Zynq UltraScale+ RFSocS

Package		Footprint Compatible Devices									
FFVD1156	XCZU21DR Production										
FFRD1156	XQZU21DR Production										
FFVE1156	XCZU25DR Production	XCZU27DR Production	XCZU28DR Production	XCZU42DR ⁽²⁾ Production	XCZU43DR ⁽¹⁾ Production	XCZU47DR ⁽¹⁾ Production	XCZU48DR ⁽¹⁾ Production	XCZU63DR ⁽²⁾ Production	XCZU64DR ⁽²⁾ Production		
FFRE1156	XQZU28DR Production	XQZU48DR ⁽¹⁾ Production									
FSVE1156	XCZU25DR Production	XCZU27DR Production	XCZU28DR Production	XCZU42DR ⁽²⁾ Production	XCZU43DR ⁽¹⁾ Production	XCZU47DR ⁽¹⁾ Production	XCZU48DR ⁽¹⁾ Production	XCZU63DR ⁽²⁾ Production	XCZU64DR ⁽²⁾ Production		
FFVG1517	XCZU25DR Production	XCZU27DR Production	XCZU28DR Production								
FFRG1517	XQZU28DR Production										
FSRG1517	XQZU48DR Production										
FSVG1517	XCZU25DR Production	XCZU27DR Production	XCZU28DR Production		XCZU43DR ⁽¹⁾ Production	XCZU47DR ⁽¹⁾ Production	XCZU48DR ⁽¹⁾ Production				
FFVF1760	XCZU29DR Production	XCZU39DR Production	XCZU49DR ⁽¹⁾ Production								
FFVH1760	XCZU46DR Production										
FFRF1760	XQZU29DR Production										
FSRF1760	XQZU49DR ⁽¹⁾ Production										
FSVF1760	XCZU29DR Production	XCZU39DR Production	XCZU49DR ⁽¹⁾ Production								



Table 3-2: Package/Device Pinout Files for Zynq UltraScale+ RFSocS (Cont'd)

Footprint Compatible Devices	
Package	
FSVH1760	XCZU46DR Production

Notes:

1. The ZU4xDR and ZU6xDR devices are footprint compatible devices. However, they have a different set of ADC and DAC power sequencing devices. Refer to *Zynq UltraScale+ RFSoc Data Sheet: DC and AC Switching Characteristics (DS926)* for specific power sequencing differences.
2. The XCZU42DR, XCZU63DR, XCZU64DR, XCZU65DR, and XCZU67DR are only partially compatible with other devices in the FFVE1156 and differences in the ADC and DAC architecture. When planning migration between devices, differences that must be addressed include ADC power rail voltage specifications.

3. Migration between the SFVD784 and SFVE784 is possible by following the guidelines in the [Migration Between SFVD784 and SFVE784](#) Pa

Device Diagrams

Summary

The diagrams in this chapter show top-view perspective of the package pinout of each Zynq™ UltraScale™ combination. [Table 4-1](#) is a cross reference to the device/package diagrams. The I/O-bank diagram shows user I/O, PSMIO, PSDDR, PSCONFIG, and PS-GTR, GTH, and GTY transceiver and the respective bank configuration-power diagram shows the location of every power pin and dedicated as well as multi-function in the package. See [Package Specifications Designations in Chapter 3](#) for definitions of [Evaluation On](#) and [Production](#) device diagrams.



IMPORTANT: All non-InFO packages are available with eutectic BGA balls. To order these packages, the device type or XA, and the Pb-free signifier in the package name is Q.

Table 4-1: Cross-Reference to Zynq UltraScale+ Device Diagrams by Package

Packages	Footprint Compatible Devices		
SBVA484	XCZU1CG XCZU1EG XAZU1EG Production page 138	XCZU2CG, XCZU2EG, XAZU2EG Production page 140	XCZU3CG, XCZU3EG, XAZU3EG Production page 140
SFRA484			XQZU3EG Production page 140



Table 4-1: Cross-Reference to Zynq UltraScale+ Device Diagrams by Package (Cont'd)

Packages		Footprint Compatible Devices			
UBVA494	XCZU1CG XCZU1EG Production page 142				
UBVA530	XCZU2CG, XCZU2EG Production page 144	XCZU3CG, XCZU3EG Production page 144			
SFVA625	XCZU1CG XCZU1EG XAZU1EG Production page 146	XCZU2CG, XCZU2EG, XAZU2EG Production page 148	XCZU3CG, XCZU3EG, XAZU3EG Production page 148		
SFVC784	XCZU1CG XCZU1EG XAZU1EG Production page 150	XCZU2CG, XCZU2EG, XAZU2EG Production page 152	XCZU3CG, XCZU3EG, XAZU3EG Production page 152	XCZU3TCG, XCZU3TEG Engineering Sample page 154	XCZU4CG, XCZU4EG, XCZU5CG, XCZU5EG Production page 158
SFRC784			XQZU3EG Production page 152	XCZU4EV, XCZU5EV, XAZU4EV, XAZU5EV Production page 160	XQZU5EV Production page 160
SFVD784				XCZU3TCG, XCZU3TEG Engineering Sample page 156	



Table 4-1: Cross-Reference to Zynq UltraScale+ Device Diagrams by Package (Cont'd)

		Footprint Compatible Devices				
SFVE784 ⁽¹⁾					XCZU4CG, XCZU4EG, XCZU4EV Production page 164	XCZU5CG, XCZU5EG, XCZU5EV Production page 164
FBVB900	XCZU4CG, XCZU4EG, XCZU5CG, XCZU5EG Production page 166	XCZU4EV, XCZU5EV Production page 168	XCZU7CG, XCZU7EG Production page 170	XCZU7EV XAZU7EV Production page 172		
FFRB900		XQZU5EV Production page 168		XQZU7EV Production page 172		
FFVC900	XCZU6CG, XCZU6EG Production page 174	XCZU9CG, XCZU9EG Production page 174	XCZU15EG Production page 174			
FFRC900		XQZU9EG Production page 174	XQZU15EG Production page 174			
FFVB1156	XCZU6CG, XCZU6EG Production page 176	XCZU9CG, XCZU9EG Production page 176	XCZU15EG Production page 176			
FFRB1156		XQZU9EG Production page 176	XQZU15EG Production page 176			



Table 4-1: Cross-Reference to Zynq UltraScale+ Device Diagrams by Package (Cont'd)

		Footprint Compatible Devices							
FFVC1156	XCZU7CG, XCZU7EG Production page 178	XCZU7EV Production page 180	XCZU11EG Production page 182						
		XQZU7EV Production page 180	XQZU11EG Production page 182						
FFVD1156	XCZU21DR Production page 184								
FFRD1156	XQZU21DR Production page 184								
FFVE1156 FSVE1156	XCZU25DR Production page 186	XCZU27DR XCZU28DR Production page 188	XCZU42DR Production page 190	XCZU43DR Production page 192	XCZU47DR Production page 194	XCZU48DR Production page 196	XCZU63DR Production page 198	XCZU64DR Production page 200	
		XQZU28DR Production page 188	XQZU48DR Production page 196						
FFRE1156									
FFVB1517	XCZU11EG Production page 206	XCZU17EG Production page 208	XCZU19EG Production page 208						
								XQZU19EG Production page 208	
FFRB1517									



Table 4-1: Cross-Reference to Zynq UltraScale+ Device Diagrams by Package (Cont'd)

Packages	Footprint Compatible Devices					
	XCZU7CG, XCZU7EG Production page 210	XCZU7EV Production page 212	XCZU11EG Production page 214	XCZU11EG Production page 214	XAZU11EG Production page 214	
FFVF1517 FSVG1517	XCZU25DR Production page 216	XCZU27DR Production page 218	XCZU28DR Production page 218	XCZU43DR Production page 220	XCZU47DR Production page 222	XCZU48DR Production page 224
FSRG1517						
FFRG1517						
FFVC1760	XCZU11EG Production page 226	XCZU17EG Production page 228	XCZU19EG Production page 228			
FFRC1760	XQZU11EG Production page 226		XQZU19EG Production page 228			
FFVD1760	XCZU17EG Production page 230	XCZU19EG Production page 230				
FFVF1760 FSVF1760	XCZU29DR Production page 232	XCZU39DR Production page 232	XCZU49DR Production page 234	XQZU49DR Production page 234		



Table 4-1: Cross-Reference to Zynq UltraScale+ Device Diagrams by Package (Cont'd)

Footprint Compatible Devices	
FFVH1760 FSVH1760	XCZU46DR Production page 236
FFRF1760	XQZU29DR Production page 232
FSRF1760	XQZU49DR Production page 234
FFVE1924	XCZU17EG Production page 238
	XCZU19EG Production page 238

Notes:

1. Migration between the SFVD784 and SFVE784 is possible by following the guidelines in the [Migration Between SFVD784 and SFVE784 Pa](#)

SBVA484 Package—XCZU1CG, XCZU1EG, XAZU1EG

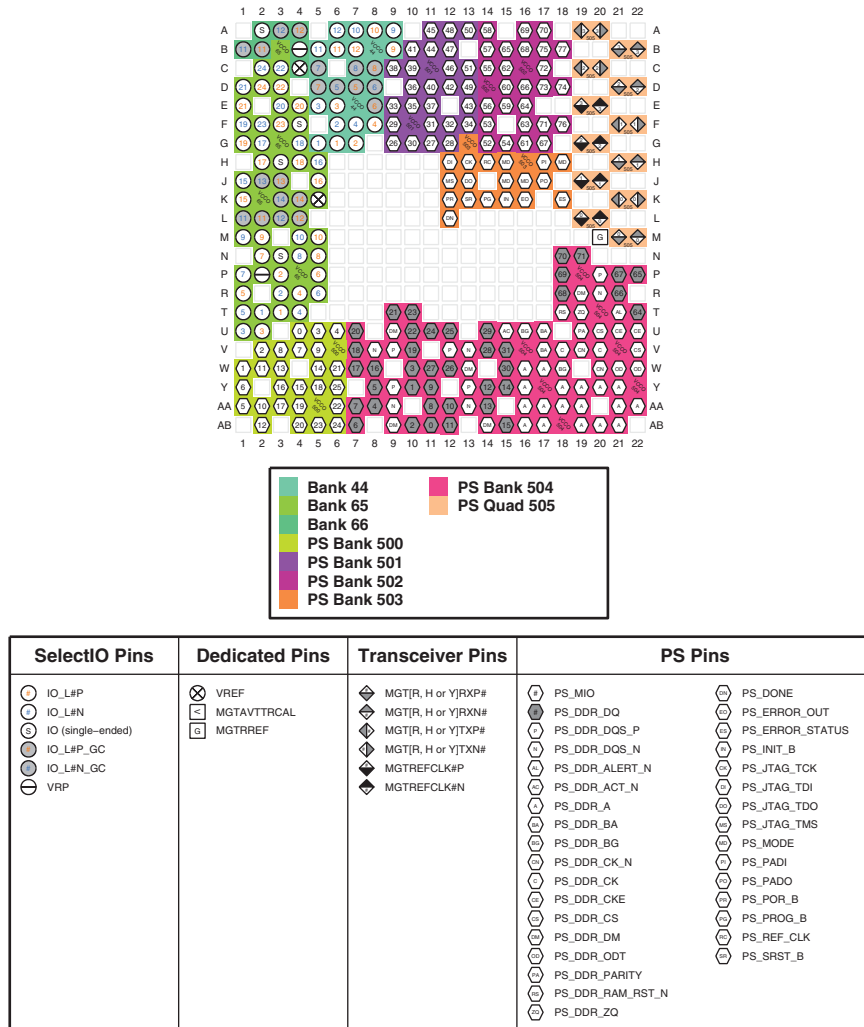

Figure 4-1: SBVA484 Package—XCZU1CG, XCZU1EG, and XAZU1EG I/O Bank Diagram

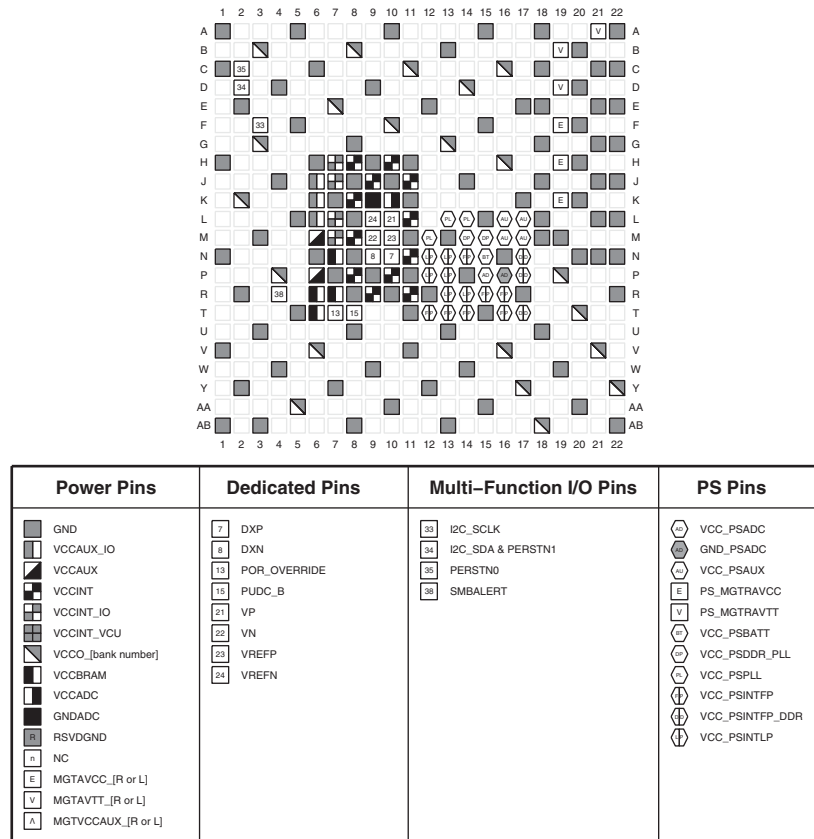

Figure 4-2: SBVA484 Package—XCZU1CG, XCZU1EG, and XAZU1EG Power, Dedicated, and Multi-function Pin Diagram

SBVA484 Package—XCZU2CG, XCZU2EG, XCZU3CG, XCZU3EG, XAZU2EG, and XAZU3EG



IMPORTANT: For the devices in the SBVA484 package, the HP I/Os in bank 66 are powered by VCCO_65.

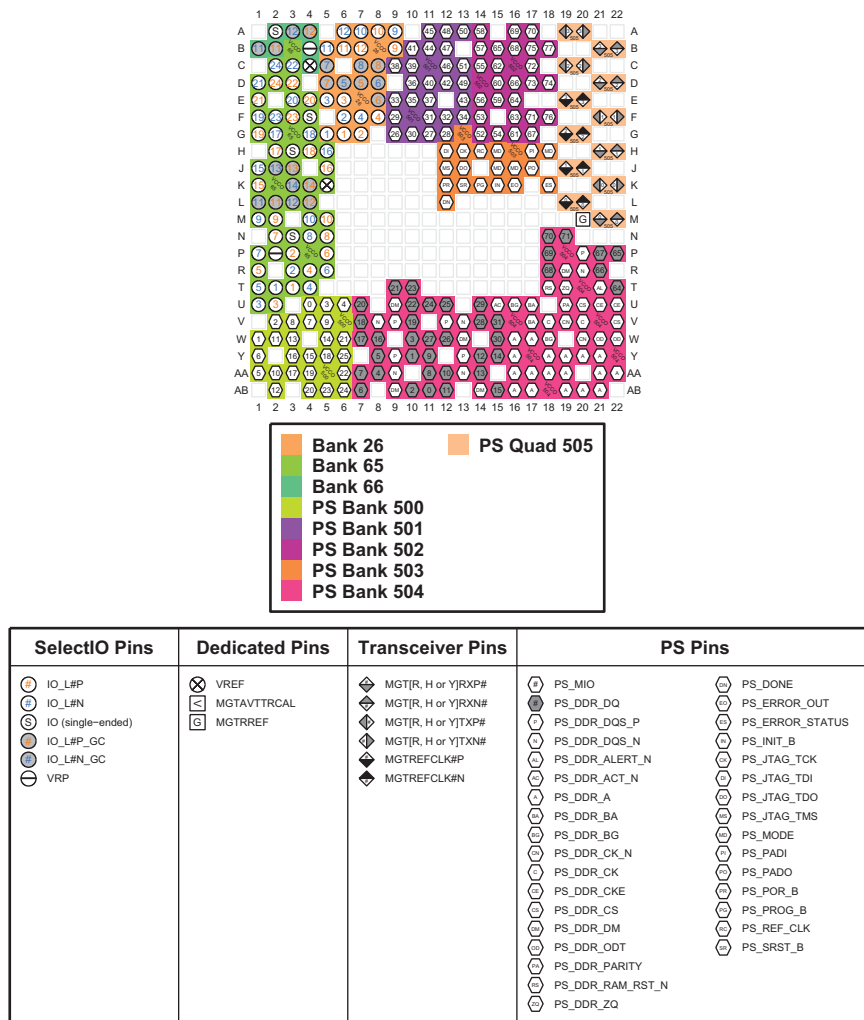

Figure 4-3: SBVA484 Package—XCZU2CG, XCZU2EG, XCZU3CG, XCZU3EG, XAZU2EG, and XAZU3EG I/O Bank Diagram

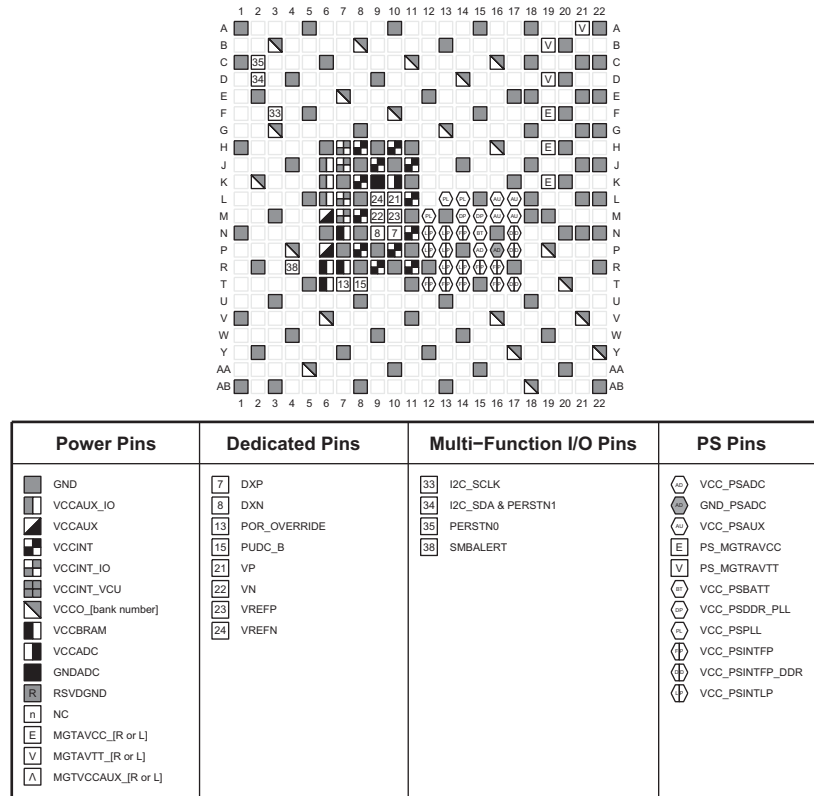

Figure 4-4: SBVA484 Package—XCZU2CG, XCZU2EG, XCZU3CG, XCZU3EG, XAZU2EG, and XAZU3EG Power, Dedicated, and Multi-function Pin Diagram

Note: VCCAUX_IO pins for the XQ versions of these devices in the SBVA484 package are split into VCCAUX_HPIO and VCCAUX_HDIO. Refer to the package files for VCCAUX_HPIO and VCCAUX_HDIO pin locations.

UBVA494 Package—XCZU1CG, XCZU1EG

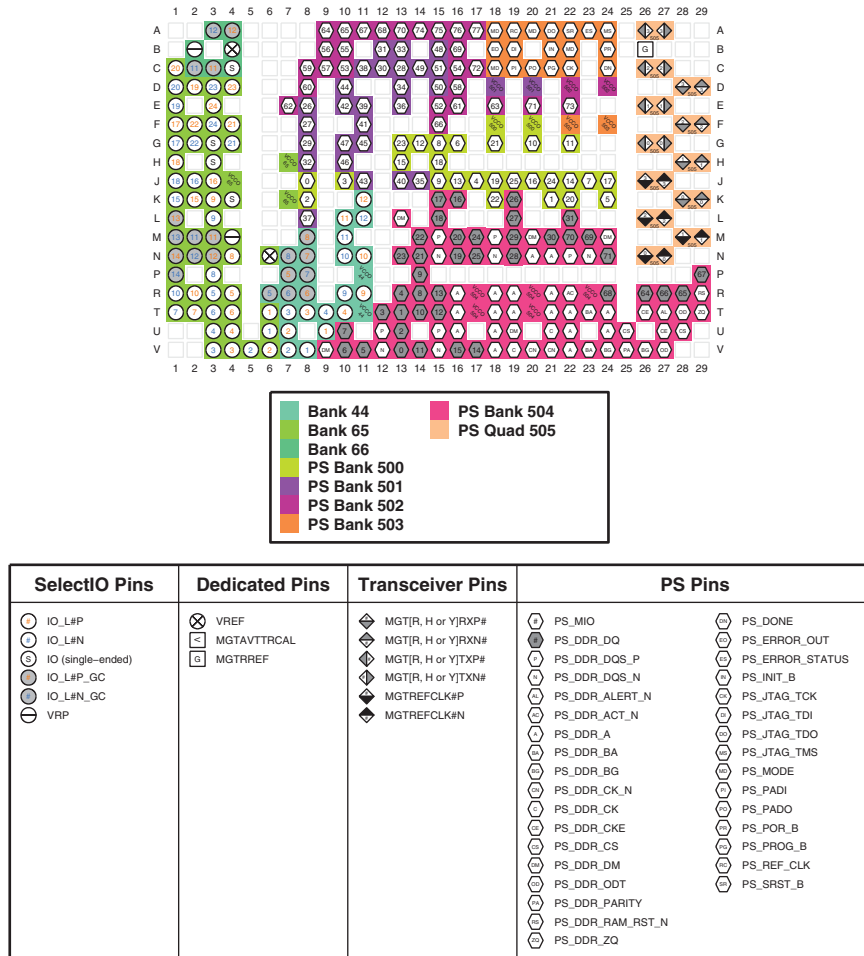

Figure 4-5: UBVA494 Package—XCZU1CG and XCZU1EG I/O Bank Diagram

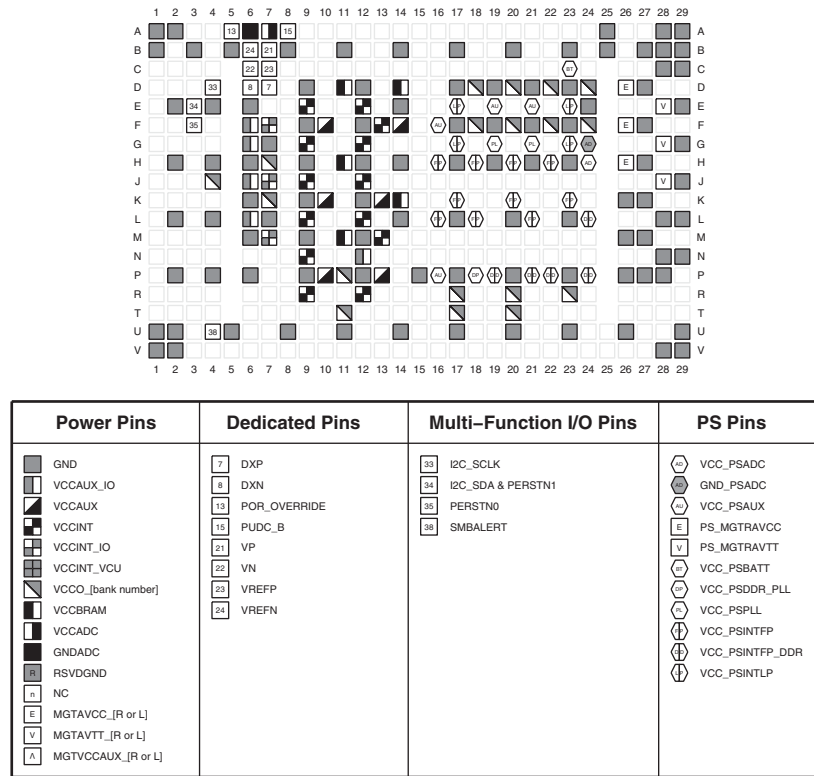

Figure 4-6: UBVA494 Package—XCZU1CG and XCZU1EG Power, Dedicated, and Multi-function Pin Diagram

UBVA530 Package—XCZU2CG, XCZU2EG, XCZU3CG, and XCZU3EG

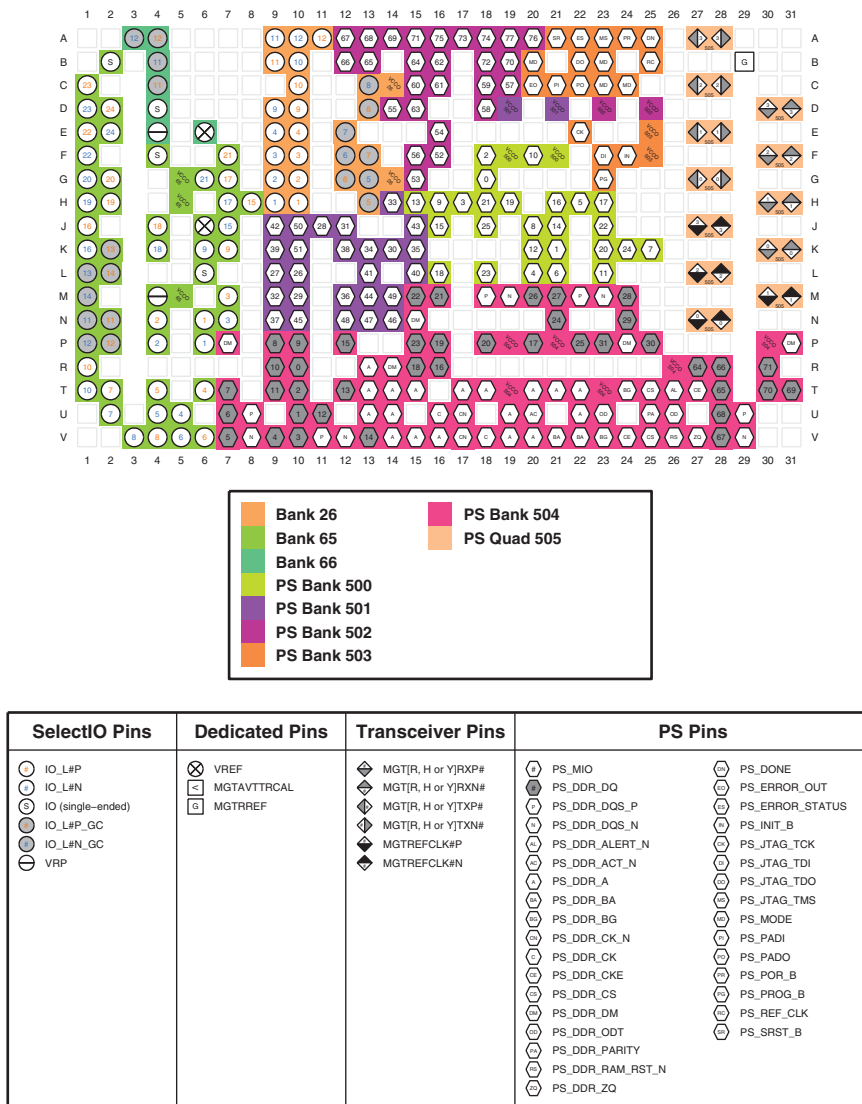

Figure 4-7: UBVA530 Package—XCZU2CG, XCZU2EG, XCZU3CG, and XCZU3EG I/O Bank Diagram

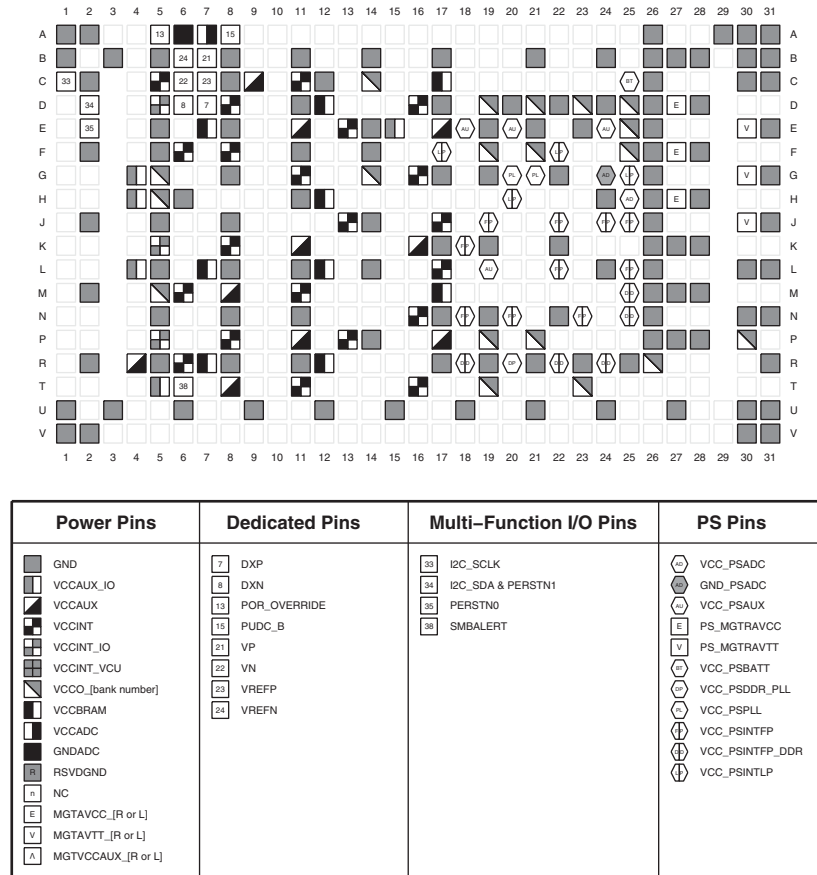

Figure 4-8: UBVA530 Package—XCZU2CG, XCZU2EG, XCZU3CG, and XCZU3EG Power, Dedicated, and Multi-function Pin Diagram

SFVA625 Package—XCZU1CG, XCZU1EG, XAZU1EG

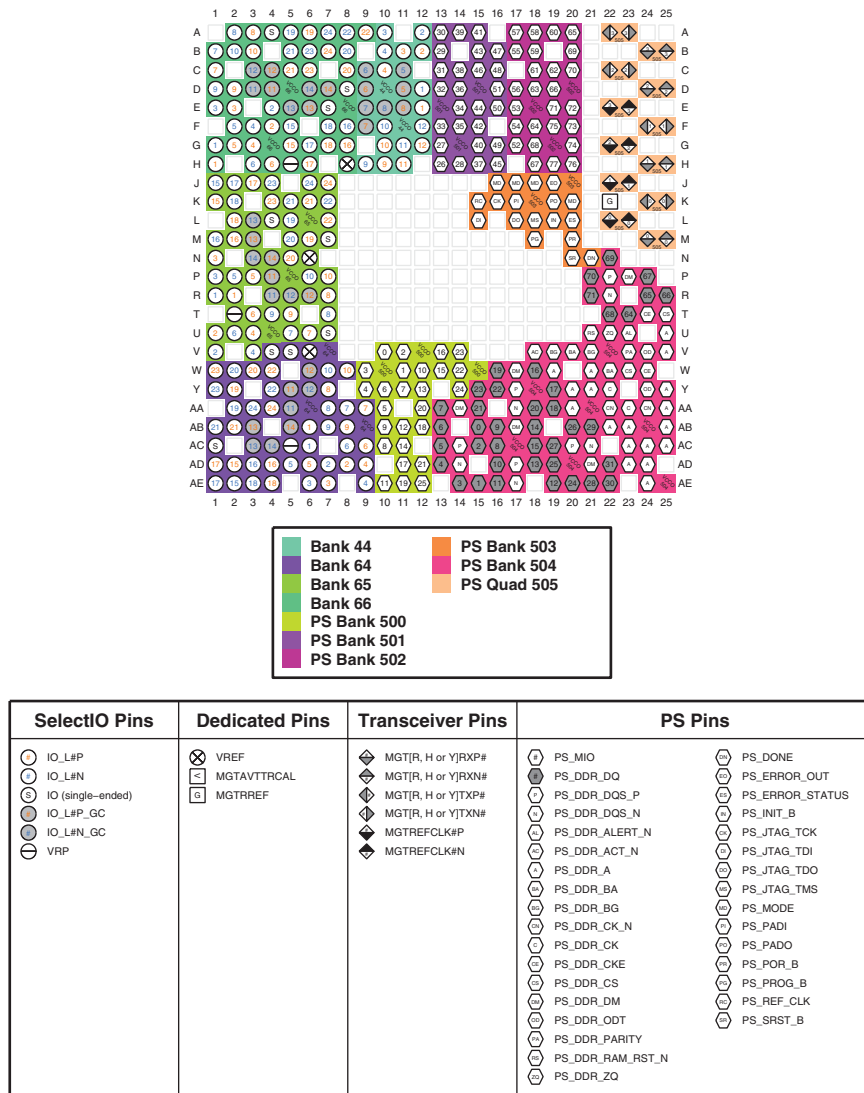
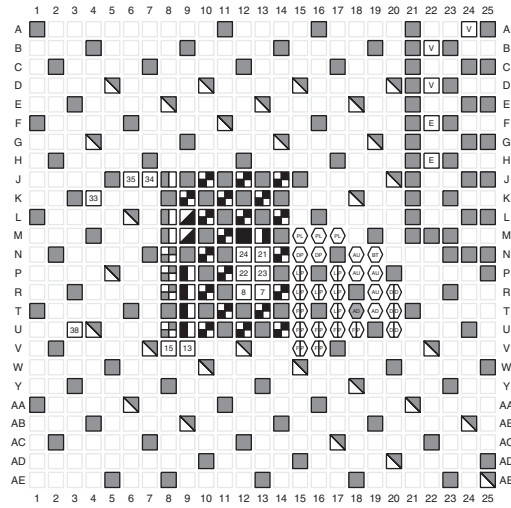

Figure 4-9: SFVA625 Package—XCZU1CG, XCZU1EG, and XAZU1EG I/O Bank Diagram



Power Pins	Dedicated Pins	Multi-Function I/O Pins	PS Pins
<ul style="list-style-type: none"> GND VCCAUX_IO VCCAUX VCCINT VCCINT_IO VCCINT_VCU VCCO_{bank number} VCCBRAM VCCADC GNDADC RSVDGND NC MGTAVCC_{R or L} MGTAVTT_{R or L} MGTVCCAUX_{R or L} 	<ul style="list-style-type: none"> 7 DXP 8 DXN 13 POR_OVERRIDE 15 PUDC_B 21 VP 22 VN 23 VREFP 24 VREFN 	<ul style="list-style-type: none"> 33 I2C_SCLK 34 I2C_SDA & PERSTN1 35 PERSTN0 38 SMBALERT 	<ul style="list-style-type: none"> VCC_PSADC GND_PSADC VCC_PSAUX PS_MGTRAVCC PS_MGTRAVTT VCC_PSABATT VCC_PSDDR_PLL VCC_PSPLL VCC_PSINTFP VCC_PSINTFP_DDR VCC_PSINTLP

Figure 4-10: SFVA625 Package—XCZU1CG, XCZU1EG, and XAZU1EG Power, Dedicated, and Multi-function Pin Diagram

SFVA625 Package—XCZU2CG, XCZU2EG, XCZU3CG, XCZU3EG, XAZU2EG, and XAZU3EG

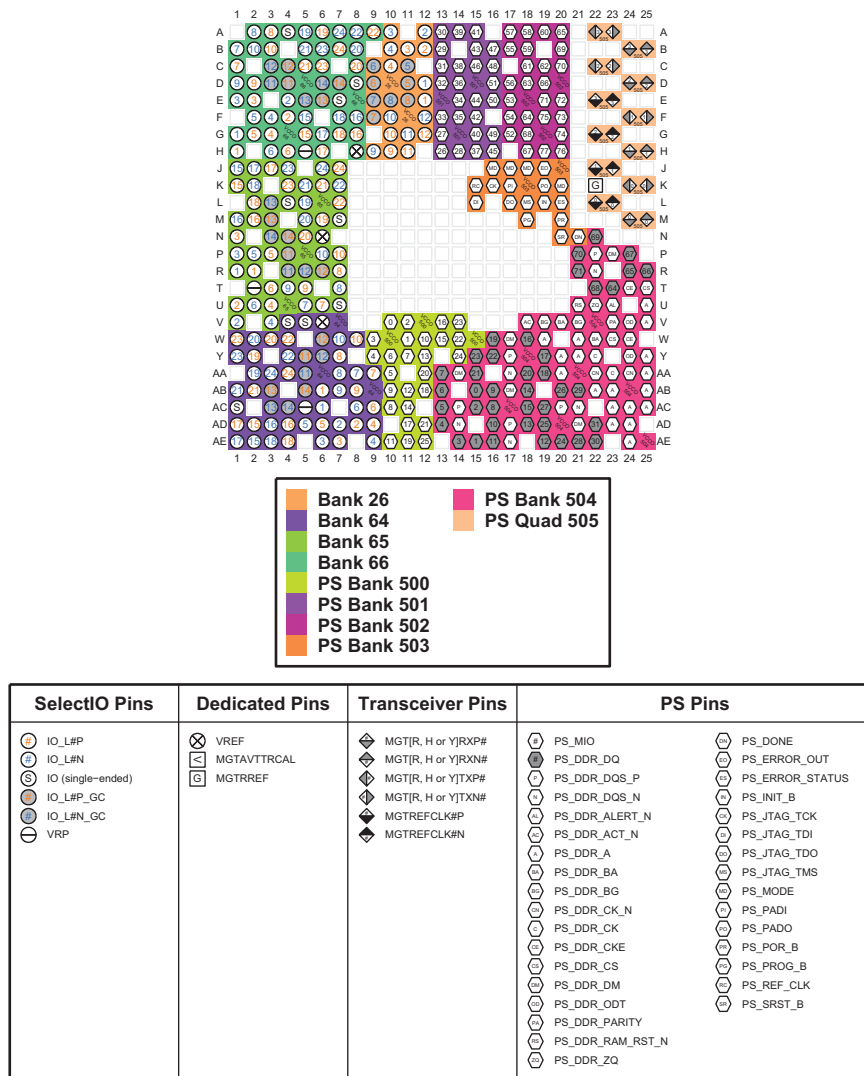

Figure 4-11: SFVA625 Package—XCZU2CG, XCZU2EG, XCZU3CG, XCZU3EG, XAZU2EG, and XAZU3EG I/O Bank Diagram

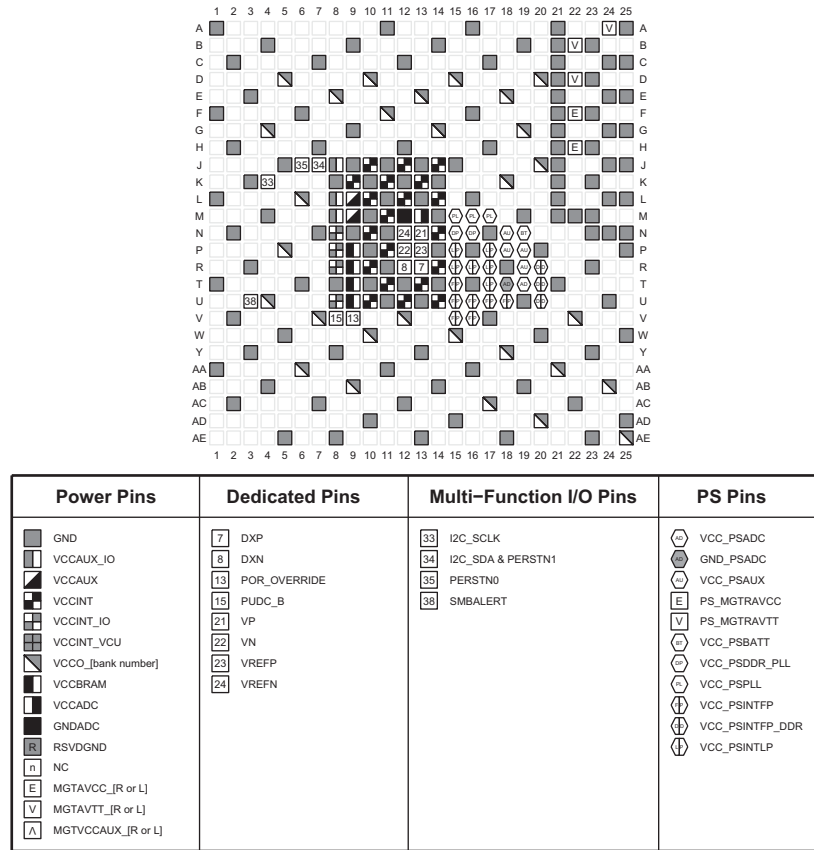

Figure 4-12: SFVA625 Package—XCZU2CG, XCZU2EG, XCZU3CG, XCZU3EG, XAZU2EG, and XAZU3EG Power, Dedicated, and Multi-function Pin Diagram

SFVC784 Package—XCZU1CG, XCZU1EG, XAZU1EG

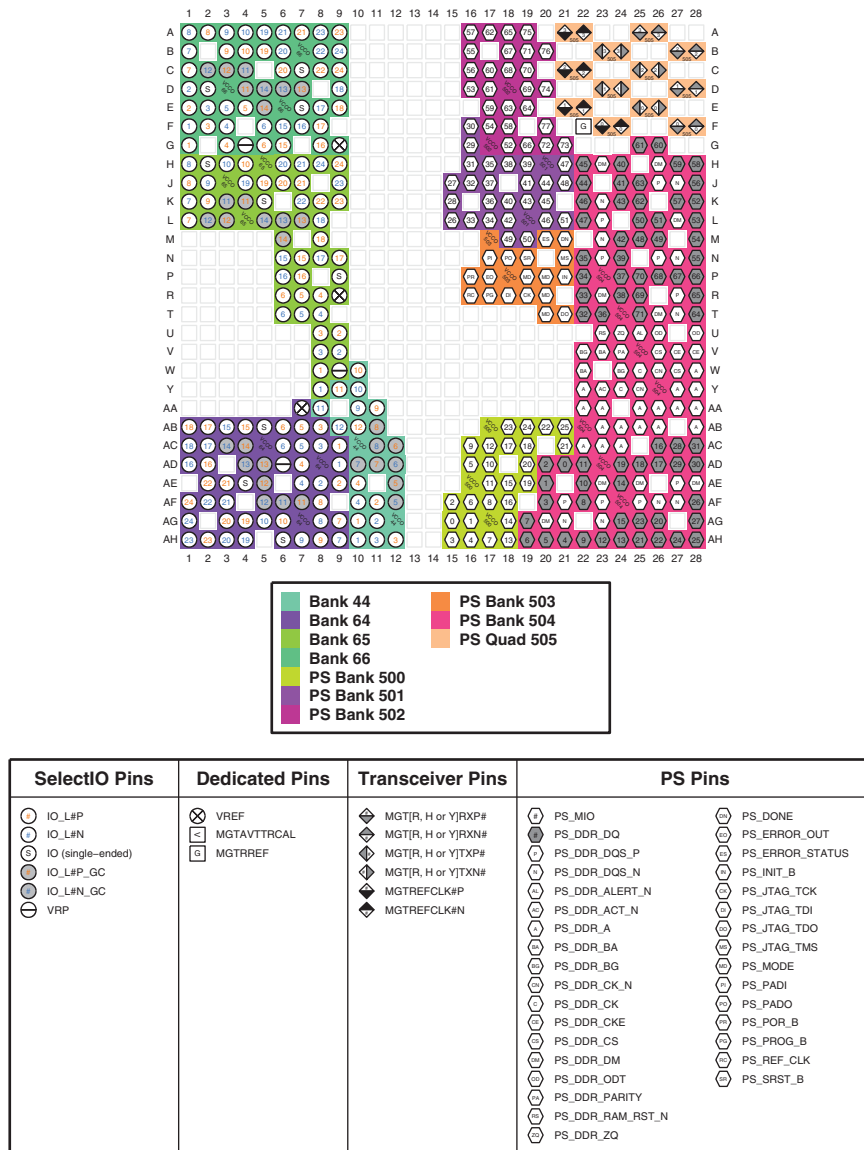
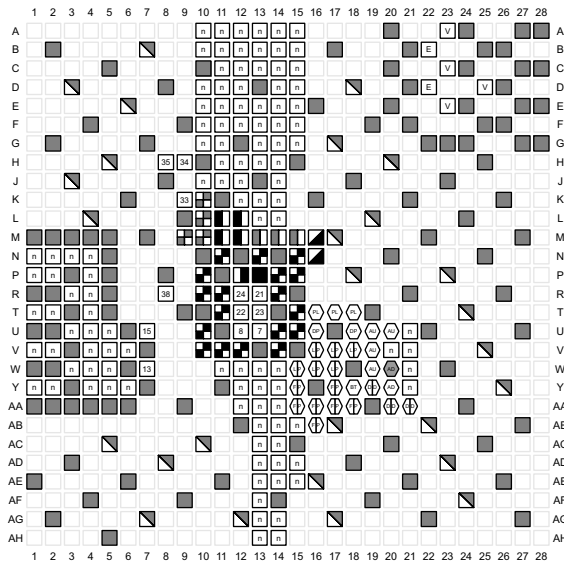

Figure 4-13: SFVC784 Package—XCZU1CG, XCZU1EG, and XAZU1EG I/O Bank Diagram



Power Pins	Dedicated Pins	Multi-Function I/O Pins	PS Pins
<ul style="list-style-type: none"> GND VCCAUX_IO VCCAUX VCCINT VCCINT_IO VCCINT_VCU VCCO_{bank number} VCCBRAM VCCADC GNDADC RSVGND NC MGTAVCC_{R or L} MGTAVTT_{R or L} MGTVCCAUX_{R or L} 	<ul style="list-style-type: none"> DXP DXN POR_OVERRIDE PUDC_B VP VN VREFP VREFN 	<ul style="list-style-type: none"> I2C_SCLK I2C_SDA & PERSTN1 PERSTN0 SMBALERT 	<ul style="list-style-type: none"> VCC_PSADC GND_PSADC VCC_PAUX PS_MGTRAVCC PS_MGTRAVTT VCC_PSBATT VCC_PSDDR_PLL VCC_PSPLL VCC_PSINTFP VCC_PSINTFP_DDR VCC_PSINTLP

Figure 4-14: SFVC784 Package—XCZU1CG, XCZU1EG, and XAZU1EG Power, Dedicated, and Multi-function Pin Diagram

SFVC784 Package—XCZU2CG, XCZU2EG, XCZU3CG, XCZU3EG, XAZU2EG, and XAZU3EG

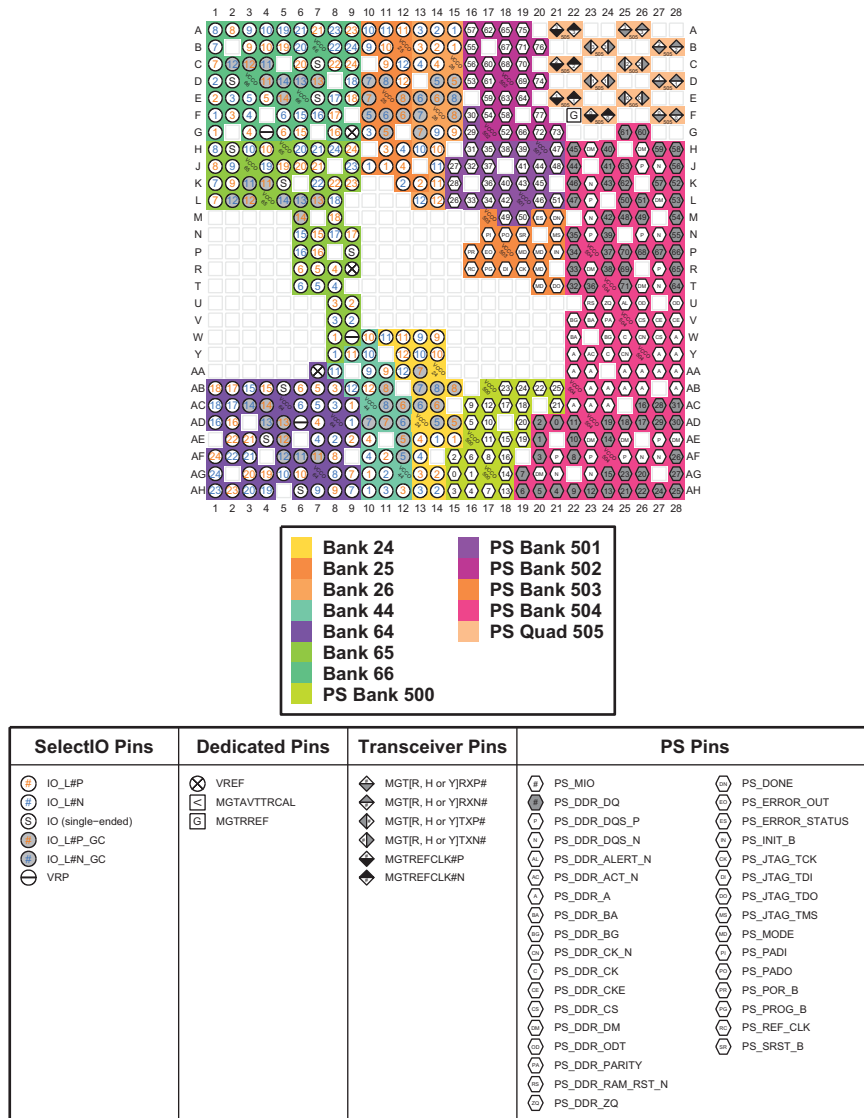

Figure 4-15: SFVC784 Package—XCZU2CG, XCZU2EG, XCZU3CG, XCZU3EG, XAZU2EG, and XAZU3EG I/O Bank Diagram

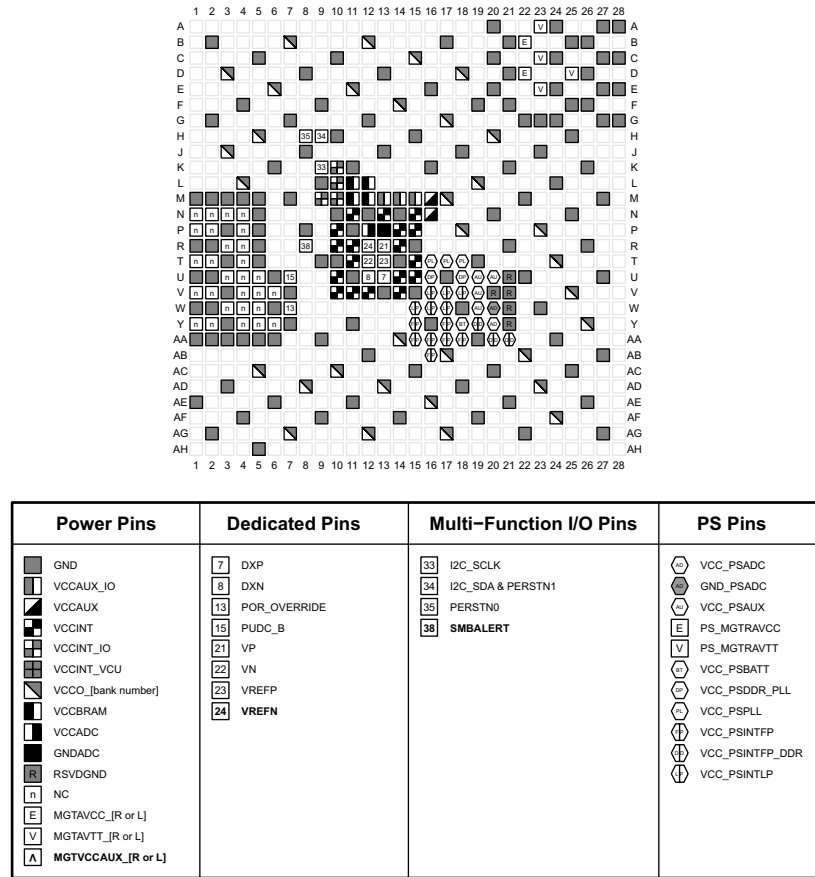

Figure 4-16: SFVC784 Package—XCZU2CG, XCZU2EG, XCZU3CG, XCZU3EG, XAZU2EG, and XAZU3EG Power, Dedicated, and Multi-function Pin Diagram

Note: VCCAUX_IO pins for the XQ versions of these devices in this package are split into VCCAUX_HPIO and VCCAUX_HDIO. Refer to the package files for VCCAUX_HPIO and VCCAUX_HDIO pin locations.

SFVC784 Package—XCZU3TCG and XCZU3TEG

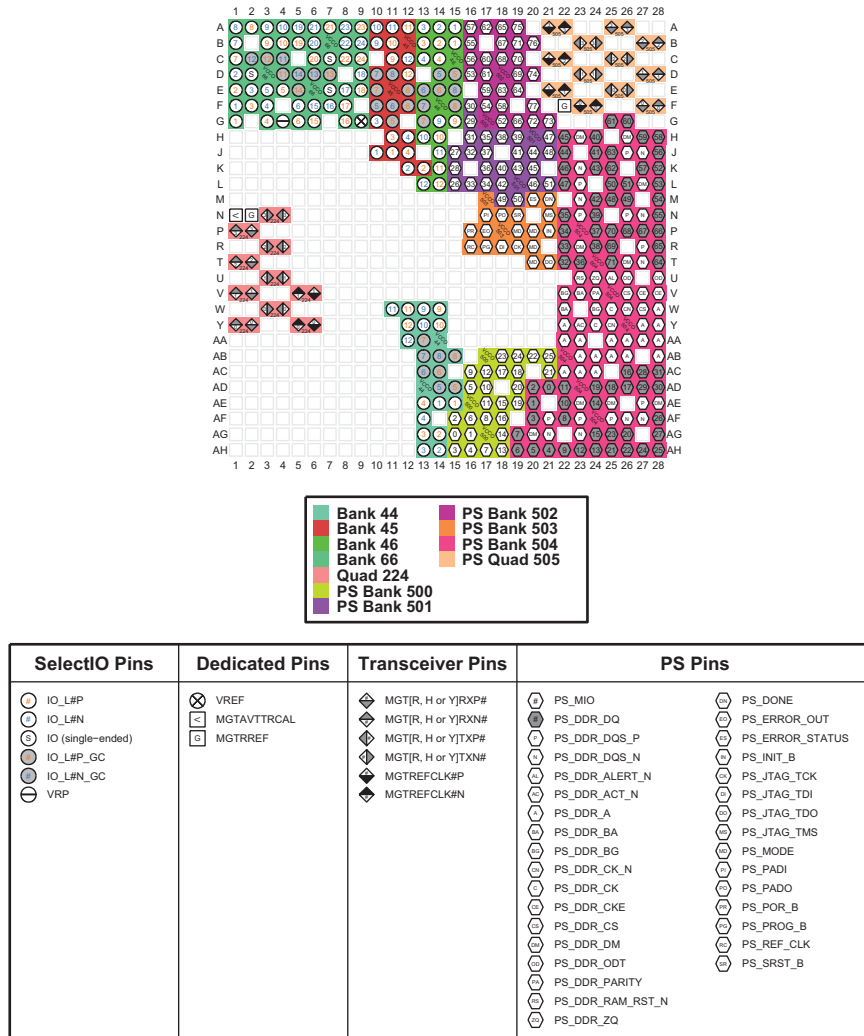
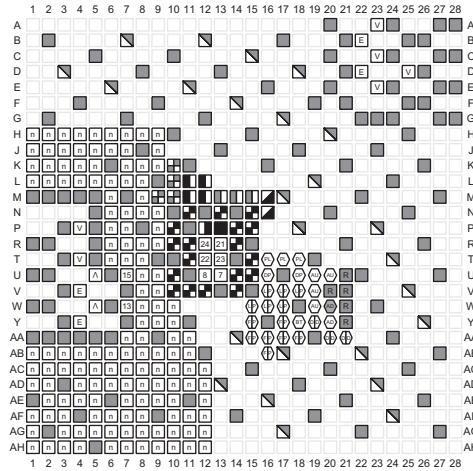

Figure 4-17: SFVC784 Package—XCZU3TCG and XCZU3TEG I/O Bank Diagram



Power Pins	Dedicated Pins	Multi-Function I/O Pins	PS Pins
<ul style="list-style-type: none"> GND VCCAUX_IO VCCAUX VCCINT VCCINT_IO VCCINT_VCU VCCO_[bank number] VCCBRAM VCCADC GNDADC RSV D GND NC MGTAVCC_[R or L] MGTAVTT_[R or L] MGTVCCAUX_[R or L] 	<ul style="list-style-type: none"> 7 DXP 8 DXN 13 POR_OVERRIDE 15 PUDC_B 21 VP 22 VN 23 VREFP 24 VREFN 	<ul style="list-style-type: none"> 33 I2C_SCLK 34 I2C_SDA & PERSTN1 35 PERSTN0 38 SMBALERT 	<ul style="list-style-type: none"> 1 VCC_PSADC 2 GND_PSADC 3 VCC_PS AUX 4 PS_MGTRAVCC 5 PS_MGTRAVTT 6 VCC_PSBATT 7 VCC_PSDDR_PLL 8 VCC_PSPLL 9 VCC_PSINTFP 10 VCC_PSINTFP_DDR 11 VCC_PSINTLP

Figure 4-18: SFVC784 Package—XCZU3TCG and XCZU3TEG Power, Dedicated, and Multi-function Pin Diagram

SFVD784 Package—XCZU3TCG and XCZU3TEG

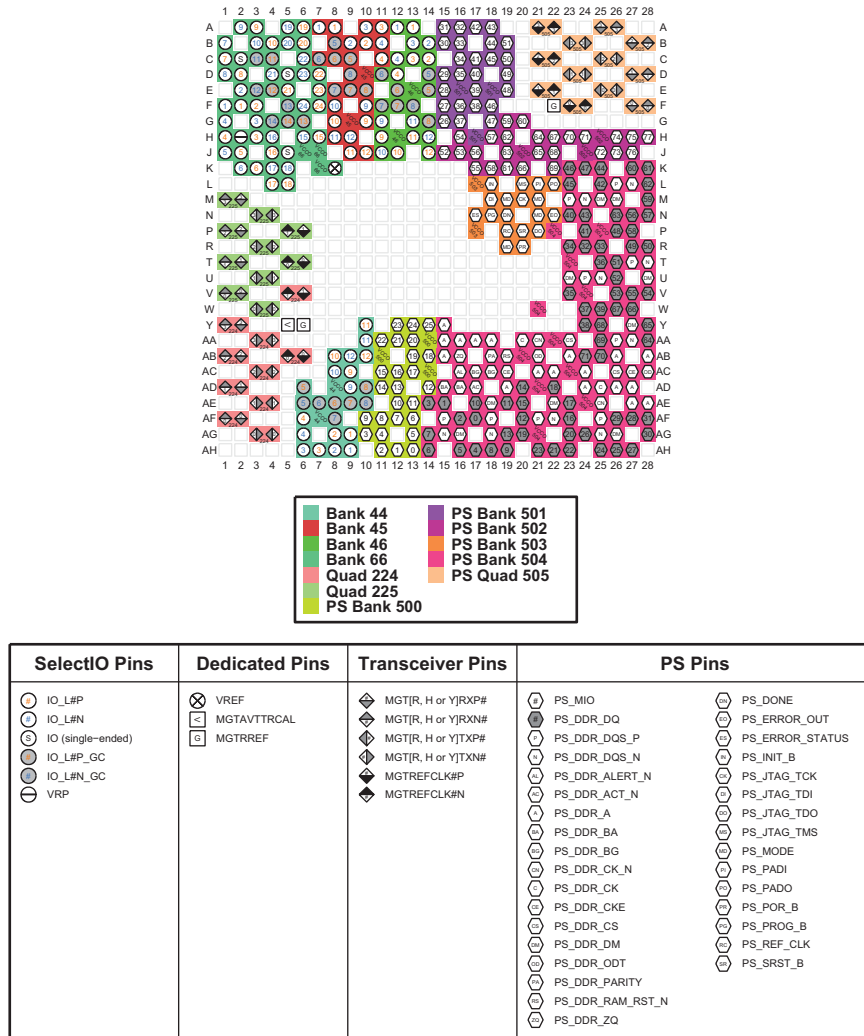
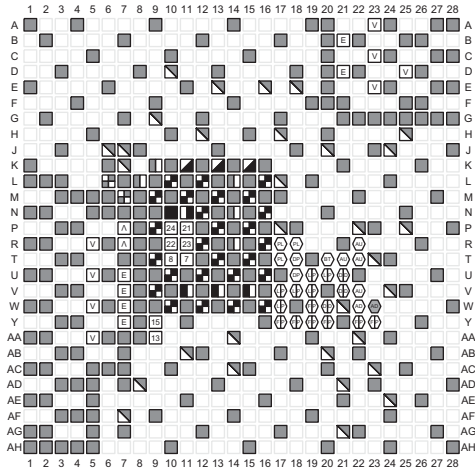

Figure 4-19: SFVD784 Package—XCZU3TCG and XCZU3TEG I/O Bank Diagram



Power Pins	Dedicated Pins	Multi-Function I/O Pins	PS Pins
<ul style="list-style-type: none"> GND VCCAUX_IO VCCAUX VCCINT VCCINT_IO VCCINT_VCU VCCO_[bank number] VCCBRAM VCCADC GNDADC RSVDGND NC MGTAVCC_[R or L] MGTAVTT_[R or L] MGTVCCAUX_[R or L] 	<ul style="list-style-type: none"> 7 DXP 8 DXN 13 POR_OVERRIDE 15 PUDC_B 21 VP 22 VN 23 VREFP 24 VREFN 	<ul style="list-style-type: none"> 33 I2C_SCLK 34 I2C_SDA & PERSTN1 35 PERSTN0 38 SMBALERT 	<ul style="list-style-type: none"> VCC_PSADC GND_PSADC VCC_PSAUX PS_MGTRAVCC PS_MGTRAVTT VCC_PSBATT VCC_PSDDR_PLL VCC_PSPLL VCC_PSINTFP VCC_PSINTFP_DDR VCC_PSINTLP

Figure 4-20: SFVD784 Package—XCZU3TCG and XCZU3TEG Power, Dedicated, and Multi-function Pin Diagram

SFVC784 Package—XCZU4CG, XCZU4EG, XCZU5CG, and XCZU5EG

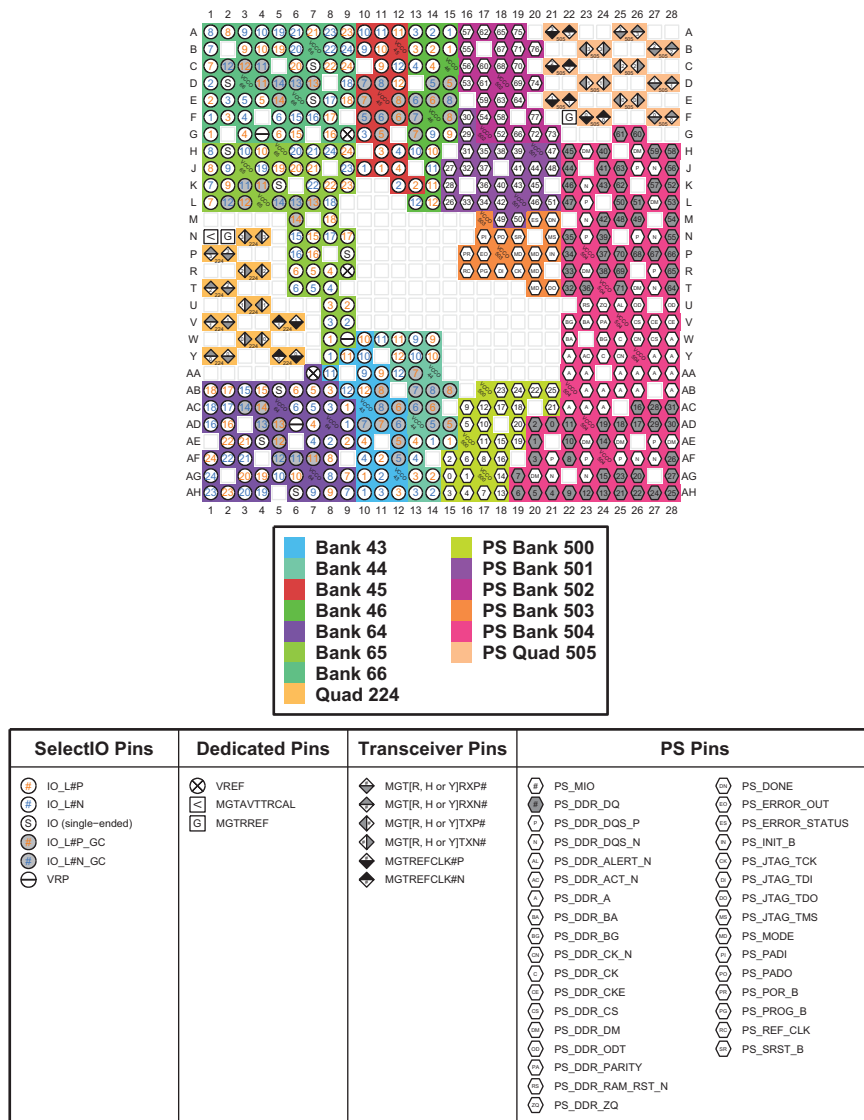

Figure 4-21: SFVC784 Package—XCZU4CG, XCZU4EG, XCZU5CG, and XCZU5EG I/O Bank Diagram

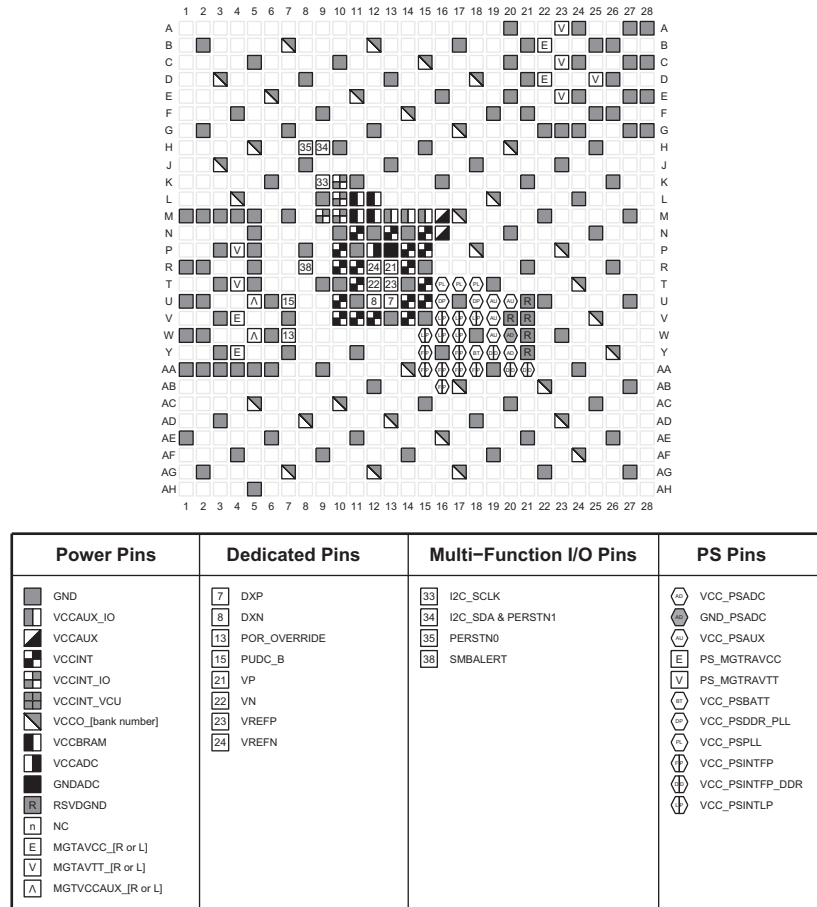

Figure 4-22: SFVC784 Package—XCZU4CG, XCZU4EG, XCZU5CG, and XCZU5EG Power, Dedicated, and Multi-function Pin Diagram

SFVC784 Package—XCZU4EV, XCZU5EV, XAZU4EV, and XAZU5EV

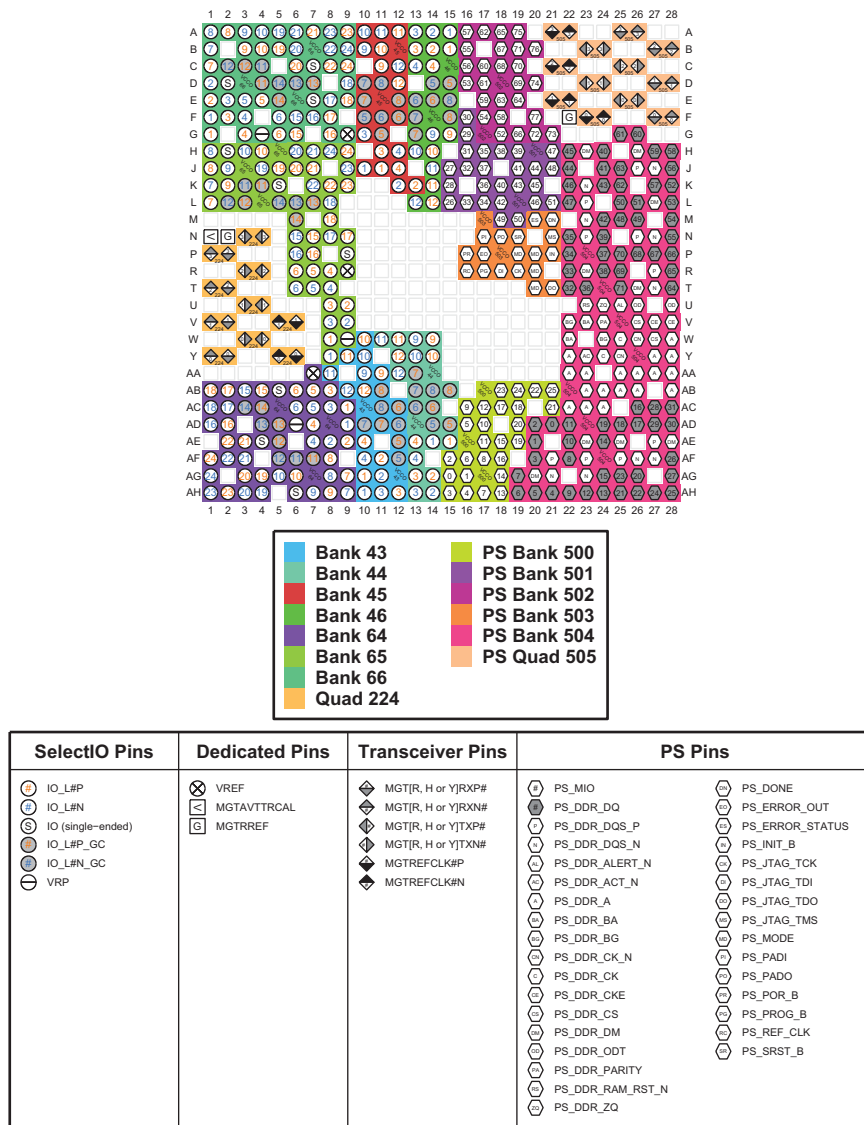

Figure 4-23: SFVC784 Package—XCZU4EV, XCZU5EV, XAZU4EV, and XAZU5EV I/O Bank Diagram

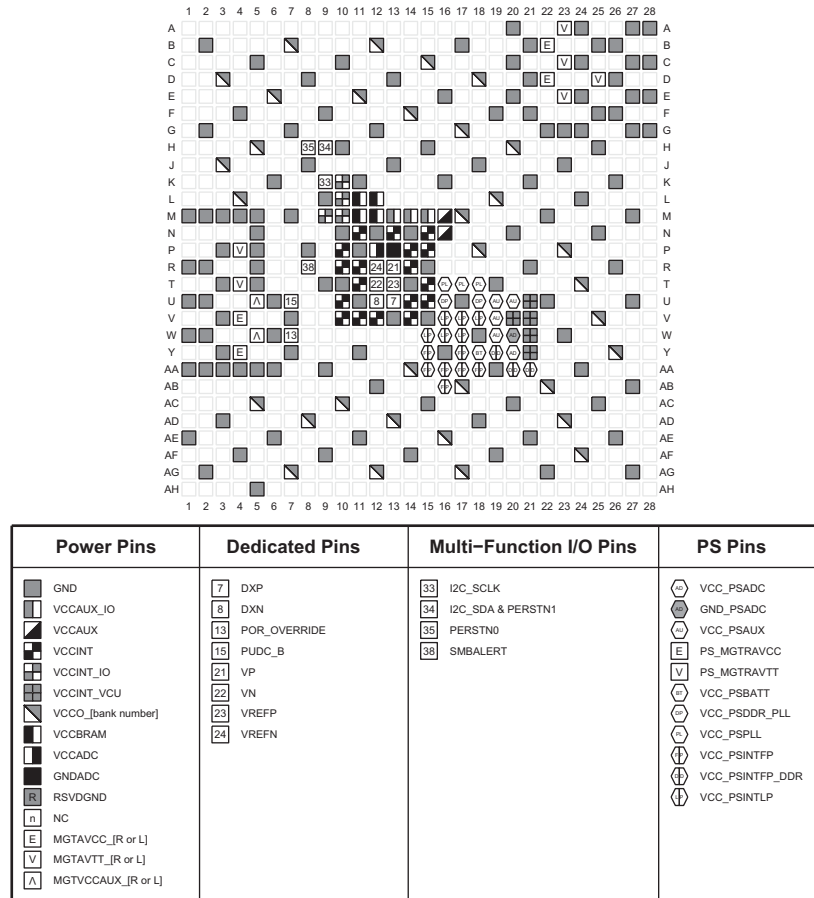
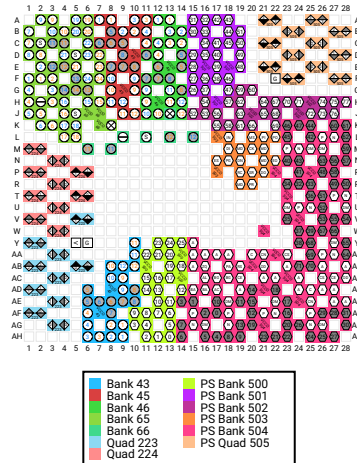

Figure 4-24: SFVC784 Package—XCZU4EV, XCZU5EV, XAZU4EV, and XAZU5EV Power, Dedicated, and Multi-function Pin Diagram

Note: VCCAUX_IO pins for the XQ versions of these devices in this package are split into VCCAUX_HPIO and VCCAUX_HDIO. Refer to the package files for VCCAUX_HPIO and VCCAUX_HDIO pin locations.

SFVE784 Package—XCZU4CG, XCZU4EG, XCZU5CG, and XCZU5EG



SelectIO Pins	Dedicated Pins	Transceiver Pins	PS Pins	
<ul style="list-style-type: none"> ○ IO_L#P ○ IO_L#N ○ IO (single-ended) ○ IO_L#P_OC ○ IO_L#N_OC ○ VREF 	<ul style="list-style-type: none"> ⊗ VREF ⊞ MGTAVTTRCAL ⊞ MGTREF 	<ul style="list-style-type: none"> ⚡ MGTJR, H or YJXP# ⚡ MGTJR, H or YJRXN# ⚡ MGTJR, H or YJTXP# ⚡ MGTJR, H or YJTXN# ⚡ MGTREFCLKP ⚡ MGTREFCLKN 	<ul style="list-style-type: none"> ○ PS_MIO ○ PS_DDR_DQ ○ PS_DDR_DQS_P ○ PS_DDR_DQS_N ○ PS_DDR_ALERT_N ○ PS_DDR_ACT_N ○ PS_DDR_A ○ PS_DDR_BA ○ PS_DDR_BG ○ PS_DDR_CK_N ○ PS_DDR_CK ○ PS_DDR_DRE ○ PS_DDR_CS ○ PS_DDR_DM ○ PS_DDR_ODT ○ PS_DDR_PARTY ○ PS_DDR_RAM_RST_N ○ PS_DDR_ZQ 	<ul style="list-style-type: none"> ○ PS_DONE ○ PS_ERROR_OUT ○ PS_ERROR_STATUS ○ PS_INT_B ○ PS_ITAG_TCK ○ PS_ITAG_TDI ○ PS_ITAG_TDO ○ PS_ITAG_TMS ○ PS_MODE ○ PS_PADI ○ PS_PADO ○ PS_POR_B ○ PS_PROG_B ○ PS_REF_CLK ○ PS_SRST_B

X29555-082224

Figure 4-25: SFVE784 Package—XCZU4CG, XCZU4EG, XCZU5CG, and XCZU5EG I/O Bank Diagram

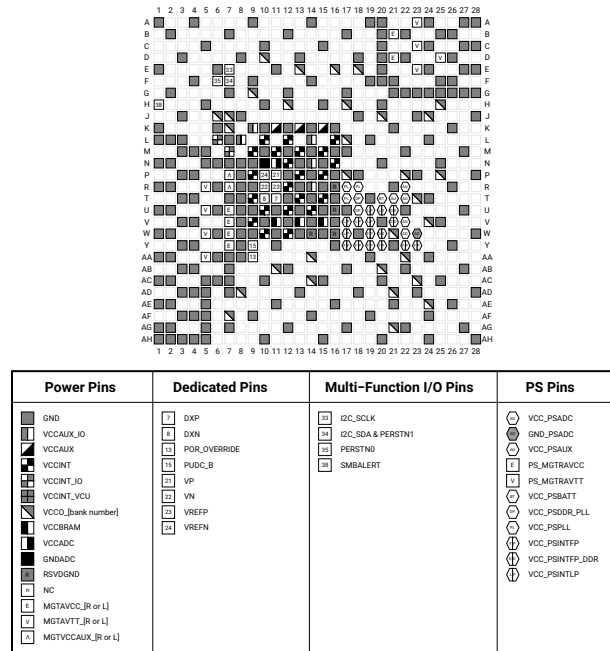

X29554-082224

Figure 4-26: SFVE784 Package—XCZU4CG, XCZU4EG, XCZU5CG, and XCZU5EG Power, Dedicated, and Multi-function Pin Diagram

SFVE784 Package—XCZU4EV and XCZU5EV

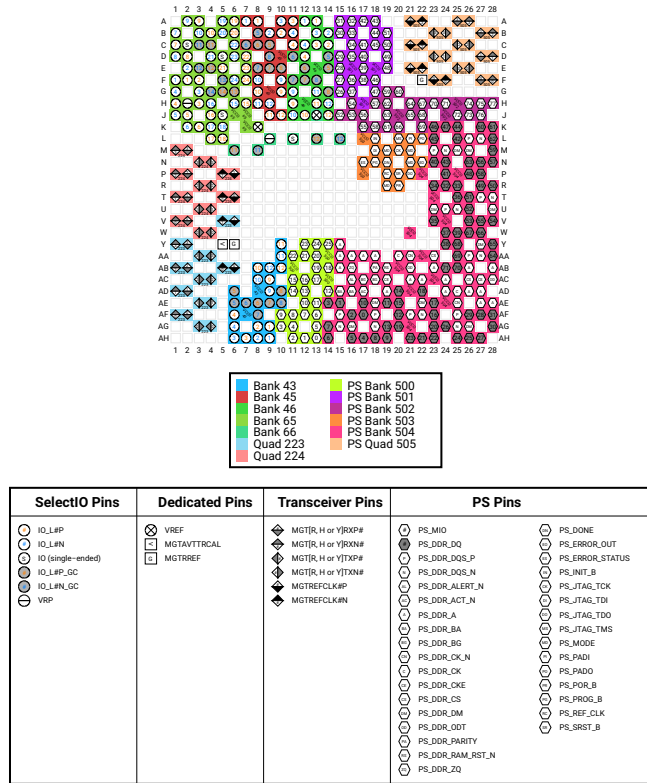

X29464-072224

Figure 4-27: SFVE784 Package—XCZU4EV and XCZU5EV I/O Bank Diagram

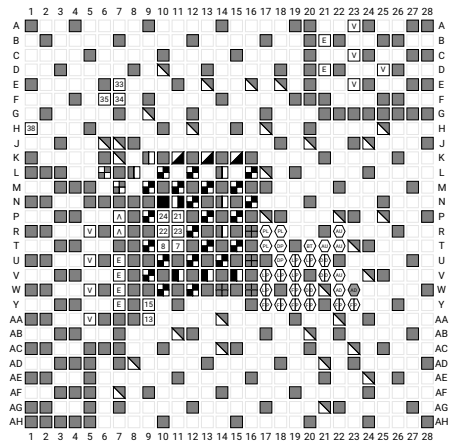

Power Pins	Dedicated Pins	Multi-Function I/O Pins	PS Pins
<ul style="list-style-type: none"> GND VCCAUX_IO VCCAUX VCCINT VCCINT_IO VCCINT_VCU VCCO_[bank number] VCCBRAM VCCADC GNDADC RSVDGND NC MGTAVCC_[R or L] MGTAVTT_[R or L] MGTVCCAUX_[R or L] 	<ul style="list-style-type: none"> 7 DXP 8 DXN 19 POR_OVERRIDE 14 PUDC_B 21 VP 22 VN 23 VREFF 24 VREFN 	<ul style="list-style-type: none"> 33 I2C_SCLK 34 I2C_SDA & PERSTN1 35 PERSTN0 36 SMBALERT 	<ul style="list-style-type: none"> VCC_PSADC GND_PSADC VCC_PS AUX PS_MGTRAVCC PS_MGTRAVTT VCC_PS BATT VCC_PSDDR_PLL VCC_PSPLL VCC_PSINTFP VCC_PSINTFP_DDR VCC_PSINTLP

X29461-072224

Figure 4-28: SFVE784 Package—XCZU4EV and XCZU5EV Power, Dedicated, and Multi-function Pin Diagram

FBVB900 Package—XCZU4CG, XCZU4EG, XCZU5CG, and XCZU5EG

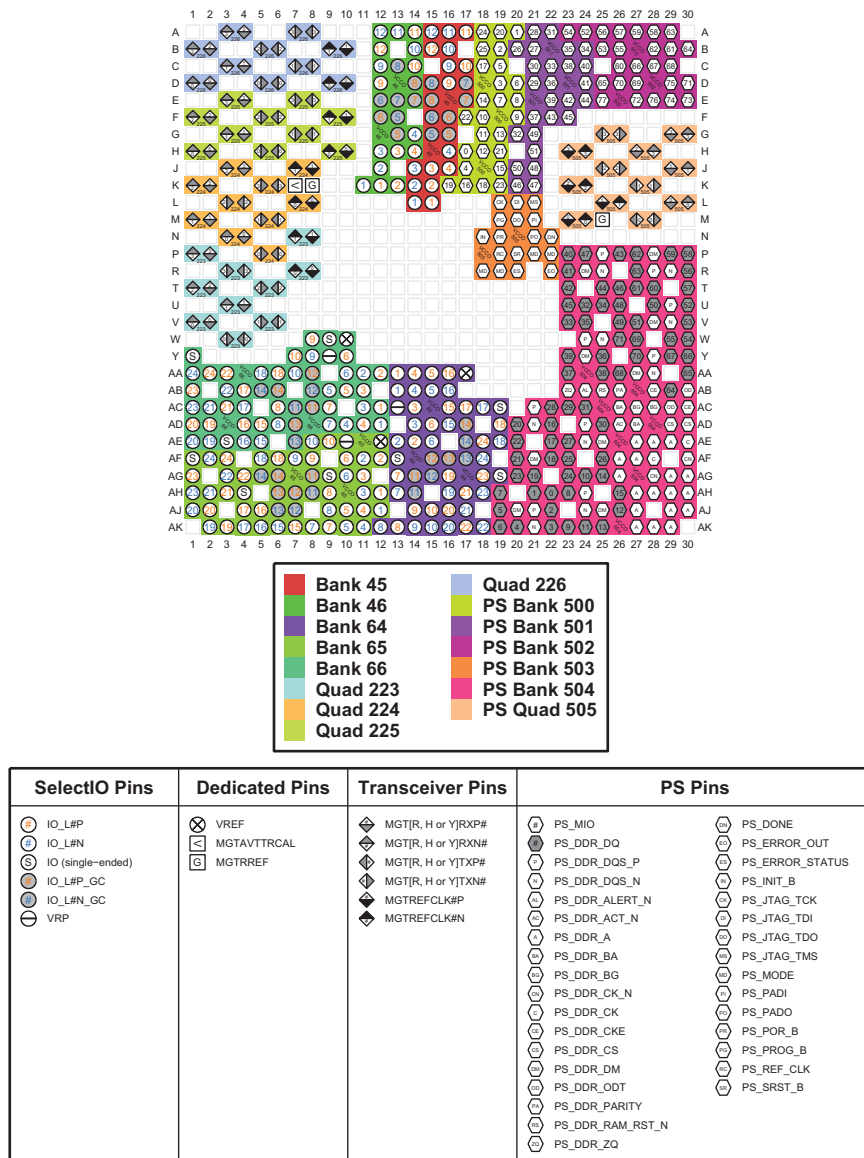
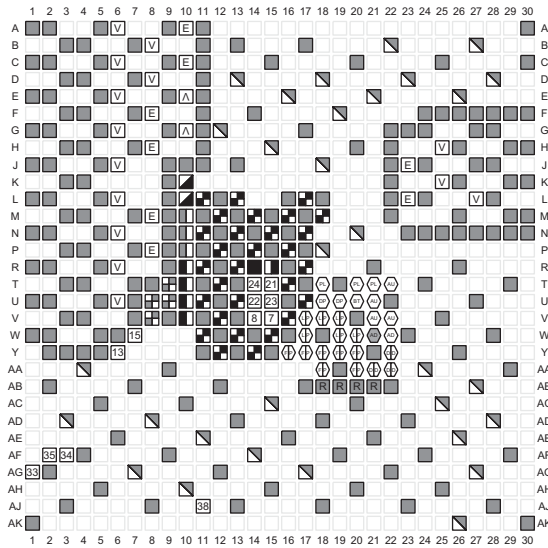

Figure 4-29: FBVB900 Package—XCZU4CG, XCZU4EG, XCZU5CG, and XCZU5EG I/O Bank Diagram



Power Pins	Dedicated Pins	Multi-Function I/O Pins	PS Pins
GND	7 DXP	33 I2C_SCLK	VCC_PSADC
VCCAUX_IO	8 DNX	34 I2C_SDA & PERSTN1	GND_PSADC
VCCAUX	13 POR_OVERRIDE	35 PERSTN0	VCC_PSAUX
VCCINT	15 PUDC_B	38 SMBALERT	PS_MGTRAVCC
VCCINT_IO	21 VP		PS_MGTRAVTT
VCCINT_VCU	22 VN		VCC_PSBATT
VCCO_{bank number}	23 VREFP		VCC_PSDDR_PLL
VCCBRAM	24 VREFN		VCC_PSPLL
VCCADC			VCC_PSINTFP
GNDADC			VCC_PSINTFP_DDR
RSVDGND			VCC_PSINTLP
NC			
MGTAVCC_{[R or L]}			
MGTAVTT_{[R or L]}			
MGTVCCAUX_{[R or L]}			

Figure 4-30: FBVB900 Package—XCZU4CG, XCZU4EG, XCZU5CG, and XCZU5EG Power, Dedicated, and Multi-function Pin Diagram

FBVB900 Package—XCZU4EV and XCZU5EV

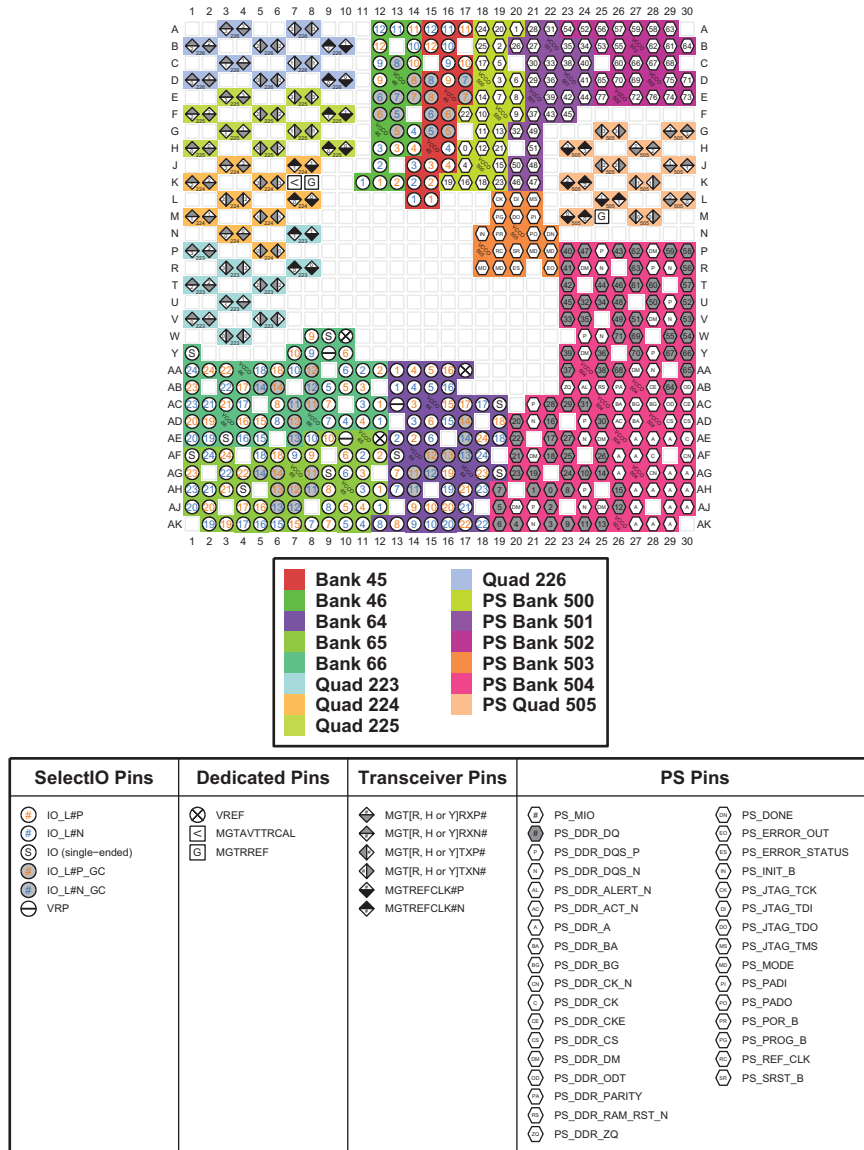

Figure 4-31: FBVB900 Package—XCZU4EV and XCZU5EV I/O Bank Diagram

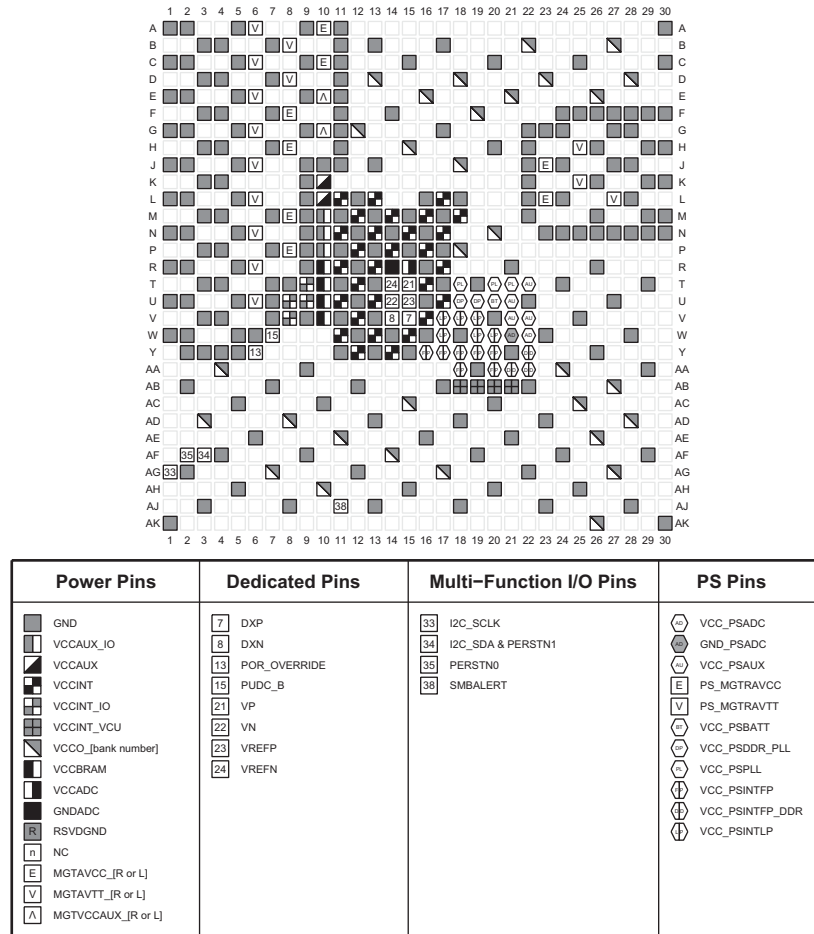

Figure 4-32: FBVB900 Package—XCZU4EV and XCZU5EV Power, Dedicated, and Multi-function Pin Diagram

Note: VCCAUX_IO pins for the XQ versions of these devices in this package are split into VCCAUX_HPIO and VCCAUX_HDIO. Refer to the package files for VCCAUX_HPIO and VCCAUX_HDIO pin locations.

FBVB900 Package—XCZU7CG and XCZU7EG

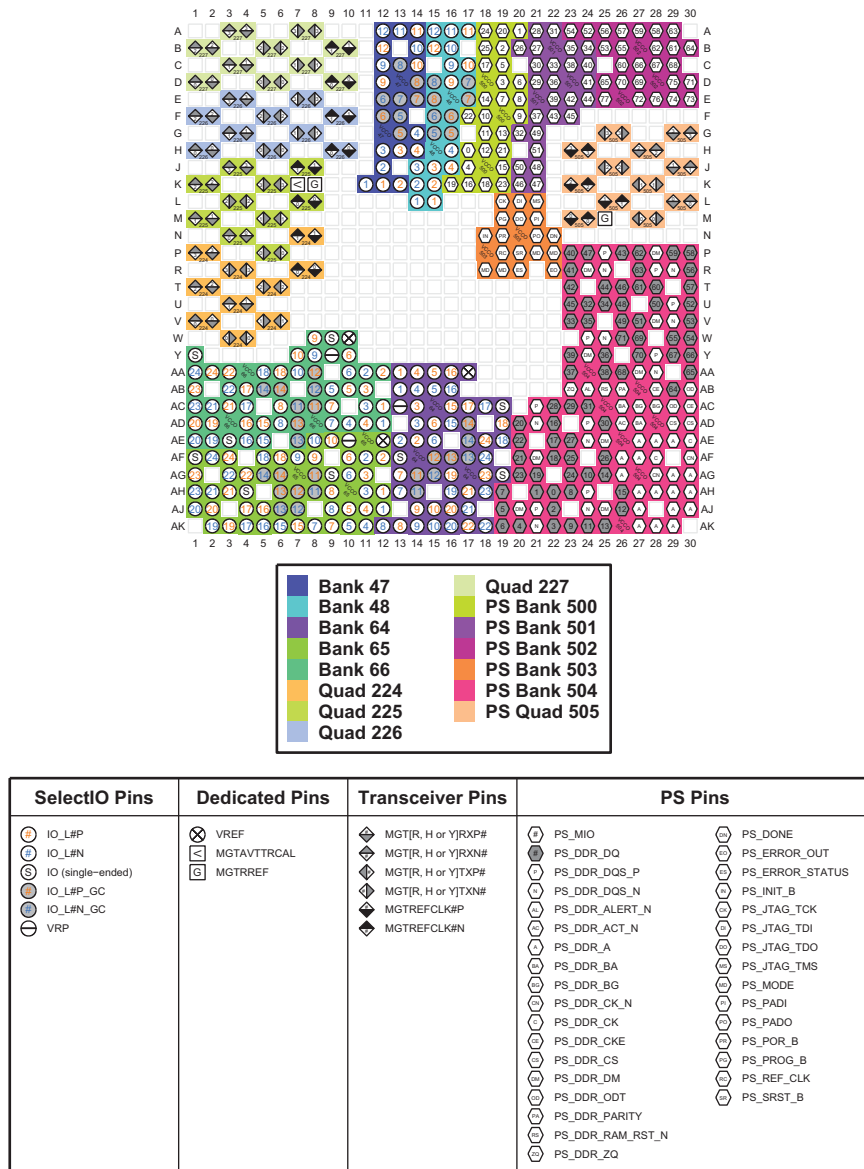
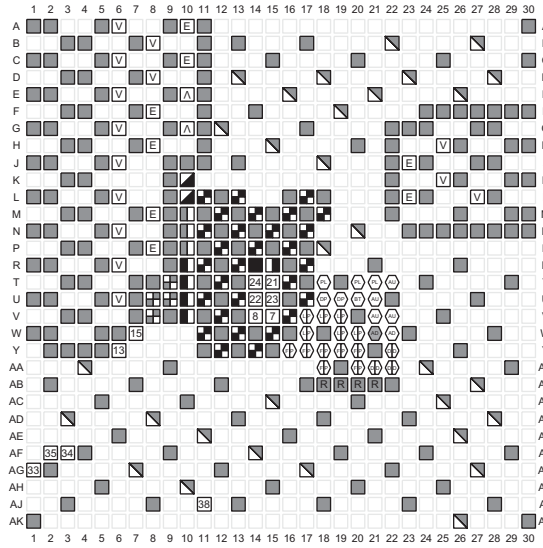

Figure 4-33: FBVB900 Package—XCZU7CG and XCZU7EG I/O Bank Diagram



Power Pins	Dedicated Pins	Multi-Function I/O Pins	PS Pins
<ul style="list-style-type: none"> GND VCCAUX_IO VCCAUX VCCINT VCCINT_IO VCCINT_VCU VCCO_[bank number] VCCBRAM VCCADC GNDADC RSVDGND NC MGTAVCC_[R or L] MGTAVTT_[R or L] MGTVCCAUX_[R or L] 	<ul style="list-style-type: none"> 7 DXP 8 DXN 13 POR_OVERRIDE 18 PUDC_B 21 VP 22 VN 23 VREFF 24 VREFN 	<ul style="list-style-type: none"> 33 I2C_SCLK 34 I2C_SDA & PERSTN1 35 PERSTN0 38 SMBALERT 	<ul style="list-style-type: none"> VCC_PSADC GND_PSADC VCC_PSAUX PS_MGTRAVCC PS_MGTRAVTT VCC_PSBATT VCC_PSDDR_PLL VCC_PSPLL VCC_PSINTFP VCC_PSINTFP_DDR VCC_PSINTLP

Figure 4-34: FBVB900 Package—XCZU7CG and XCZU7EG Power, Dedicated, and Multi-function Pin Diagram

FBVB900 Package—XCZU7EV

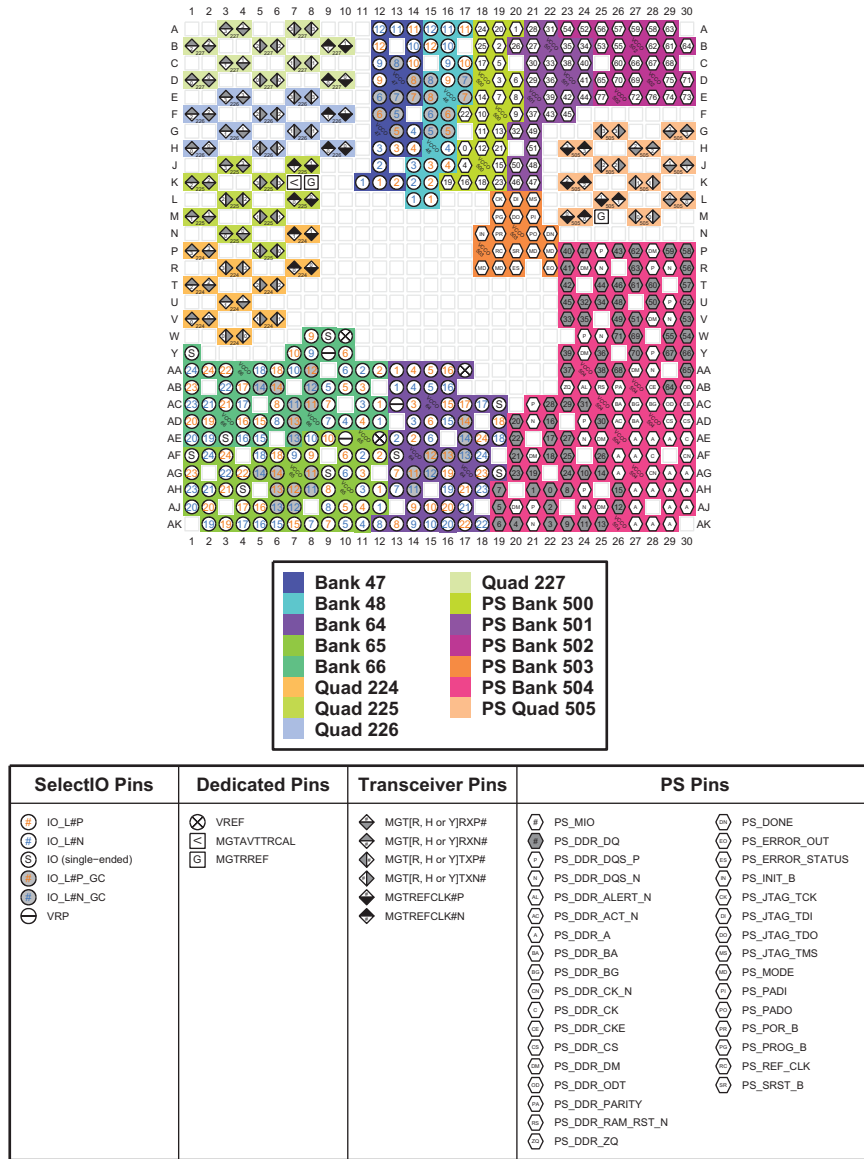

Figure 4-35: FBVB900 Package—XCZU7EV I/O Bank Diagram

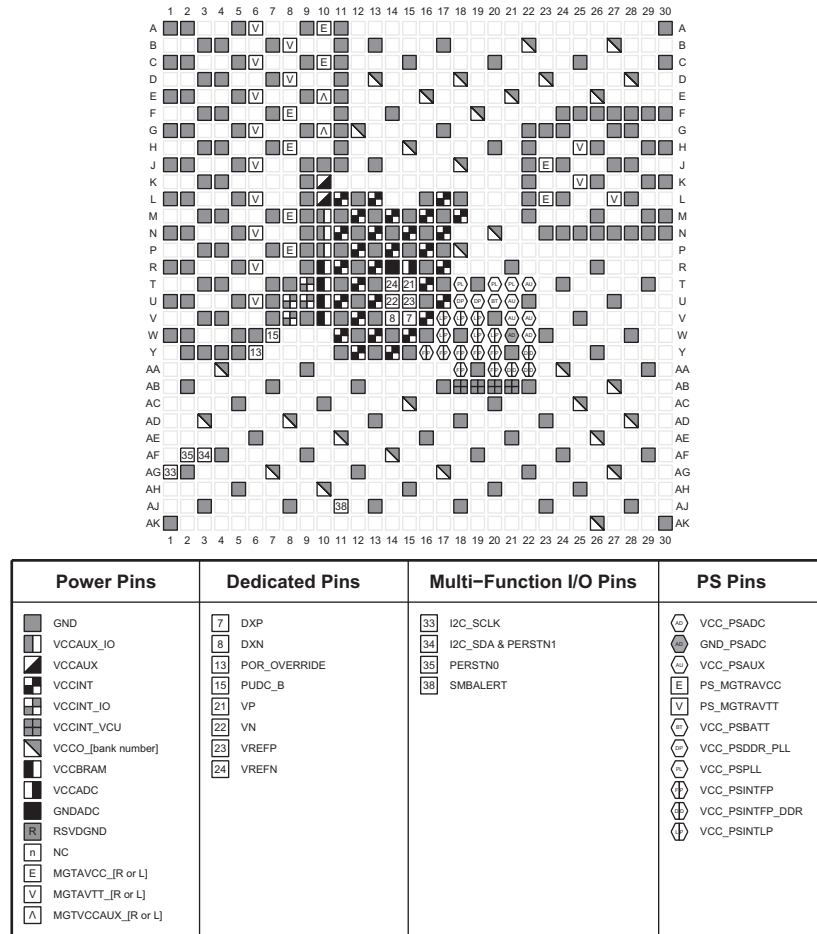

Figure 4-36: FBVB900 Package—XCZU7EV Power, Dedicated, and Multi-function Pin Diagram

Note: VCCAUX_IO pins for the XQ versions of these devices in this package are split into VCCAUX_HPIO and VCCAUX_HDIO. Refer to the package files for VCCAUX_HPIO and VCCAUX_HDIO pin locations.

FFVC900 Package—XCZU6CG, XCZU6EG, XCZU9CG, XCZU9EG, and XCZU15EG

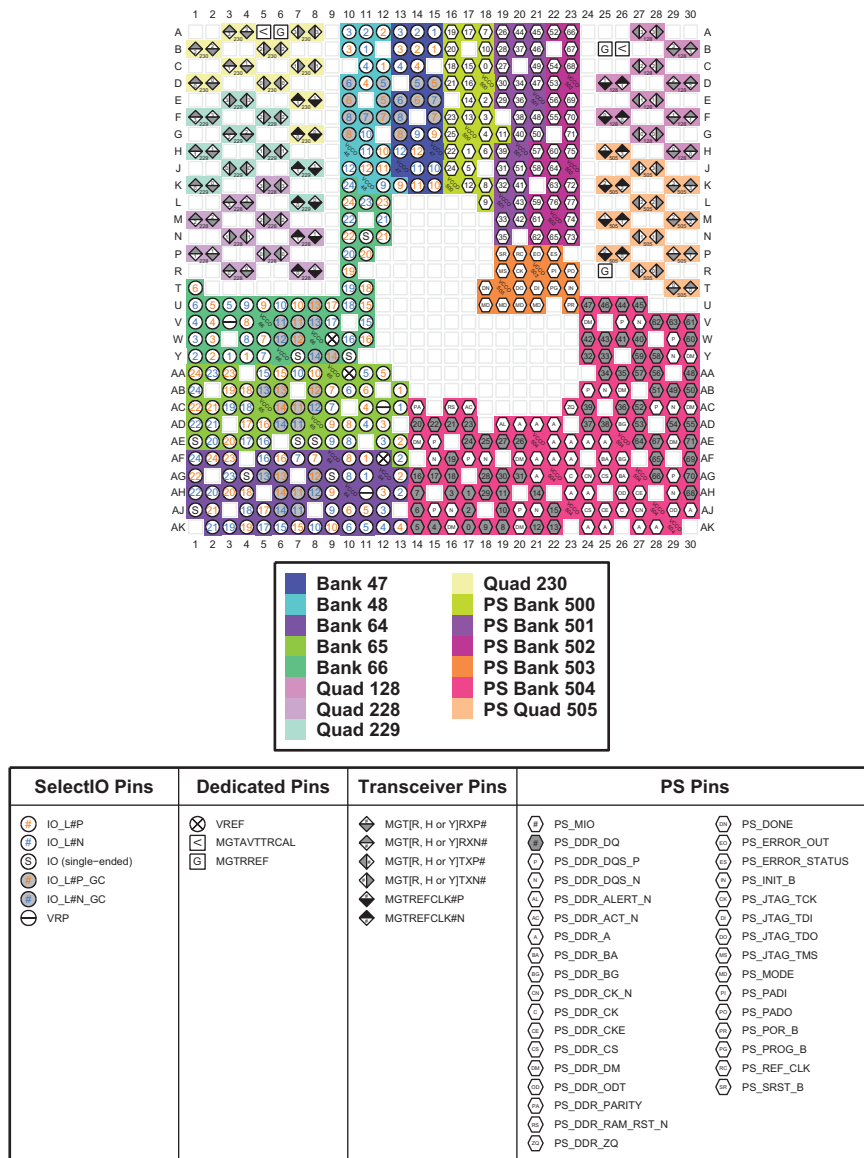

Figure 4-37: FFVC900 Package—XCZU6CG, XCZU6EG, XCZU9CG, XCZU9EG, and XCZU15EG I/O Bank Diagram

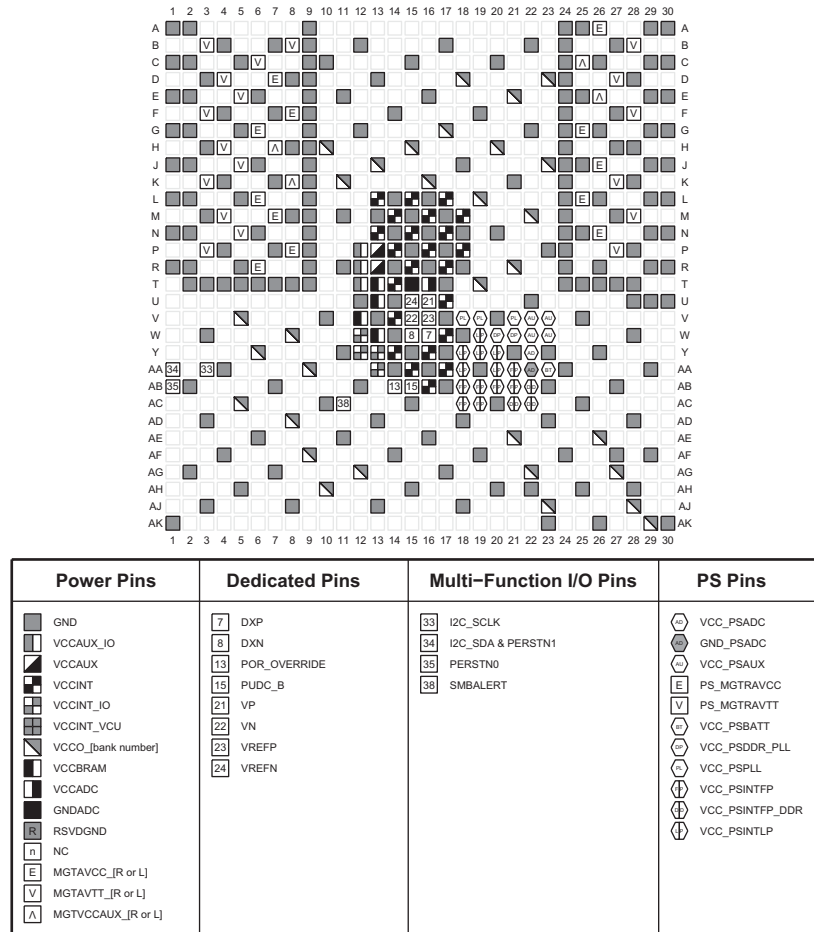

Figure 4-38: FFVC900 Package—XCZU6CG, XCZU6EG, XCZU9CG, XCZU9EG, and XCZU15EG Power, Dedicated, and Multi-function Pin Diagram

Note: VCCAUX_IO pins for the XQ versions of these devices in this package are split into VCCAUX_HPIO and VCCAUX_HDIO. Refer to the package files for VCCAUX_HPIO and VCCAUX_HDIO pin locations.

FFVB1156 Package—XCZU6CG, XCZU6EG, XCZU9CG, XCZU9EG, and XCZU15EG

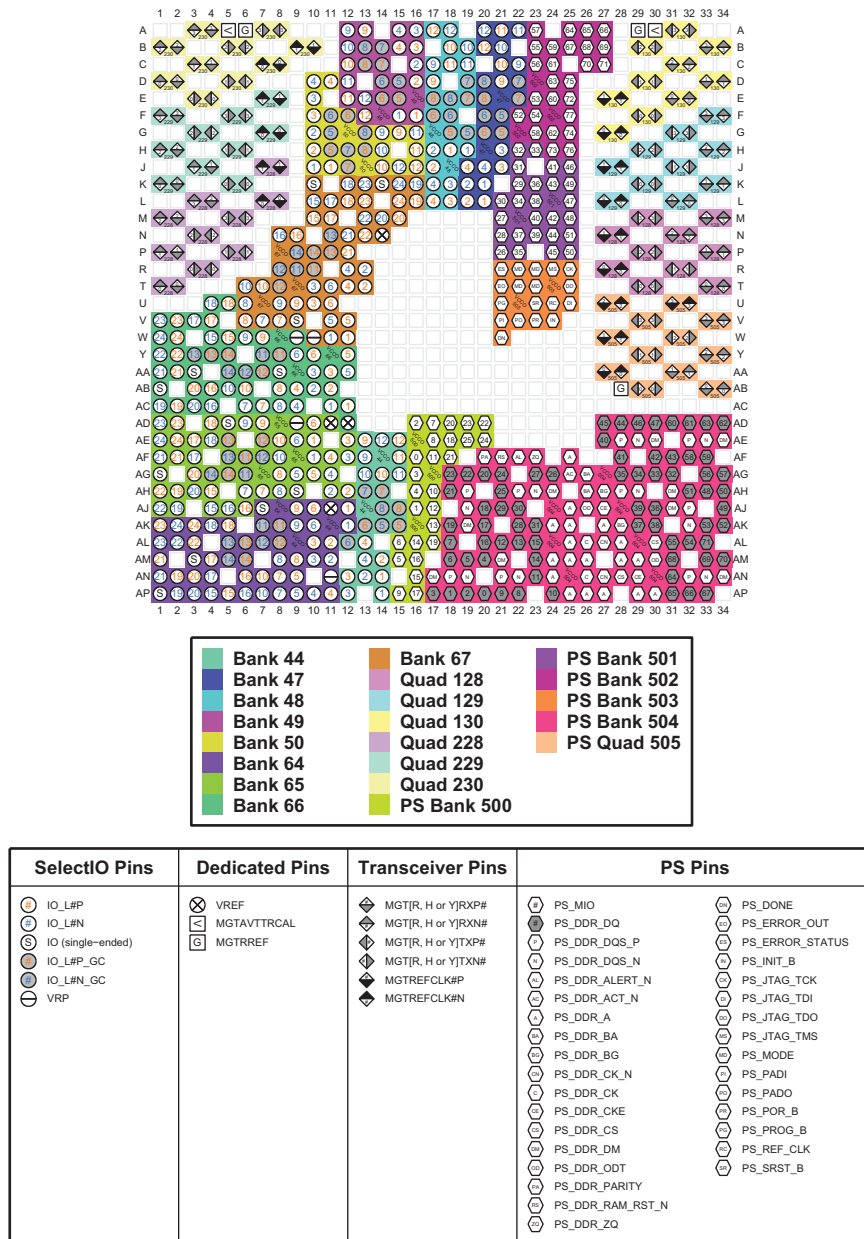

Figure 4-39: FFVB1156 Package—XCZU6CG, XCZU6EG, XCZU9CG, XCZU9EG, and XCZU15EG I/O Bank Diagram

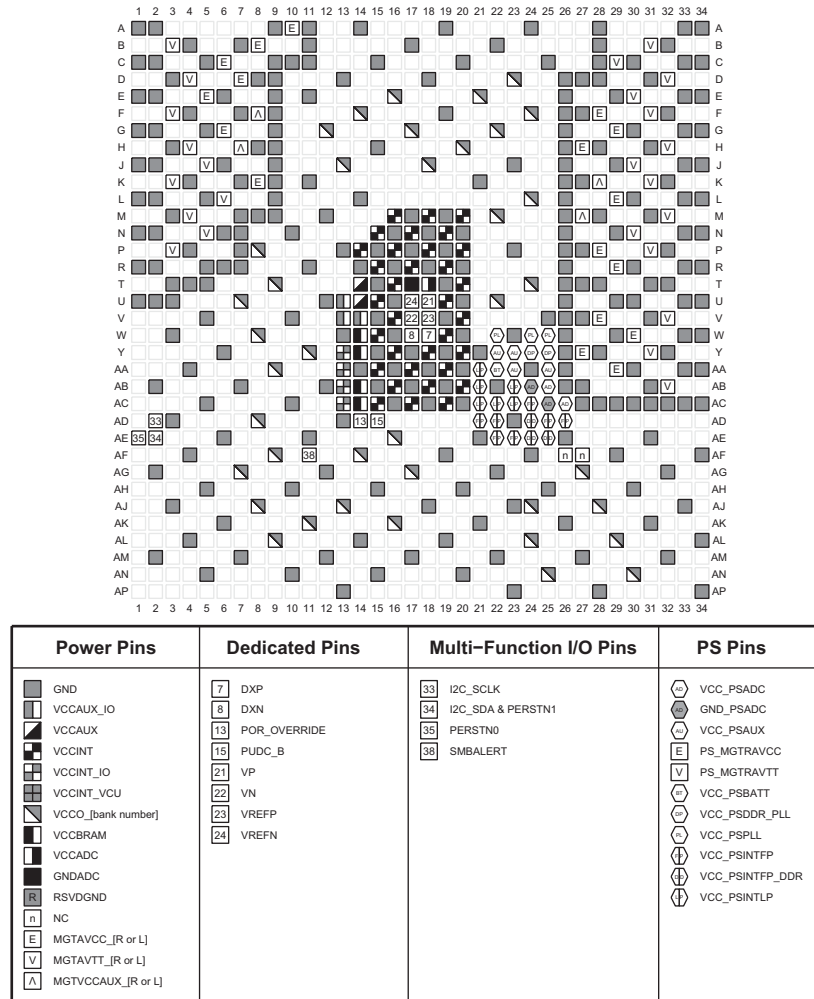

Figure 4-40: FFVB1156 Package—XCZU6CG, XCZU6EG, XCZU9CG, XCZU9EG, and XCZU15EG Power, Dedicated, and Multi-function Pin Diagram

Note: VCCAUX_IO pins for the XQ versions of these devices in this package are split into VCCAUX_HPIO and VCCAUX_HDIO. Refer to the package files for VCCAUX_HPIO and VCCAUX_HDIO pin locations.

FFVC1156 Package—XCZU7CG and XCZU7EG

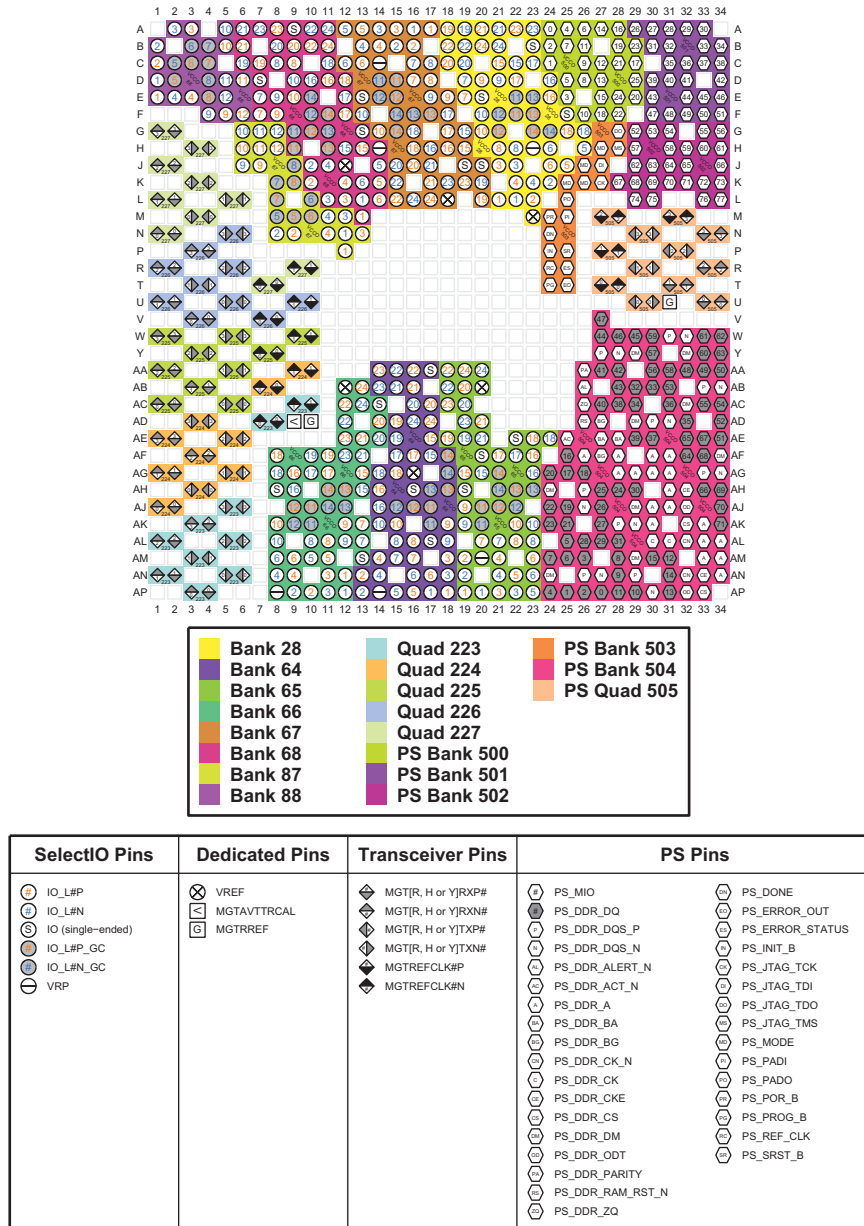

Figure 4-41: FFVC1156 Package—XCZU7CG and XCZU7EG I/O Bank Diagram

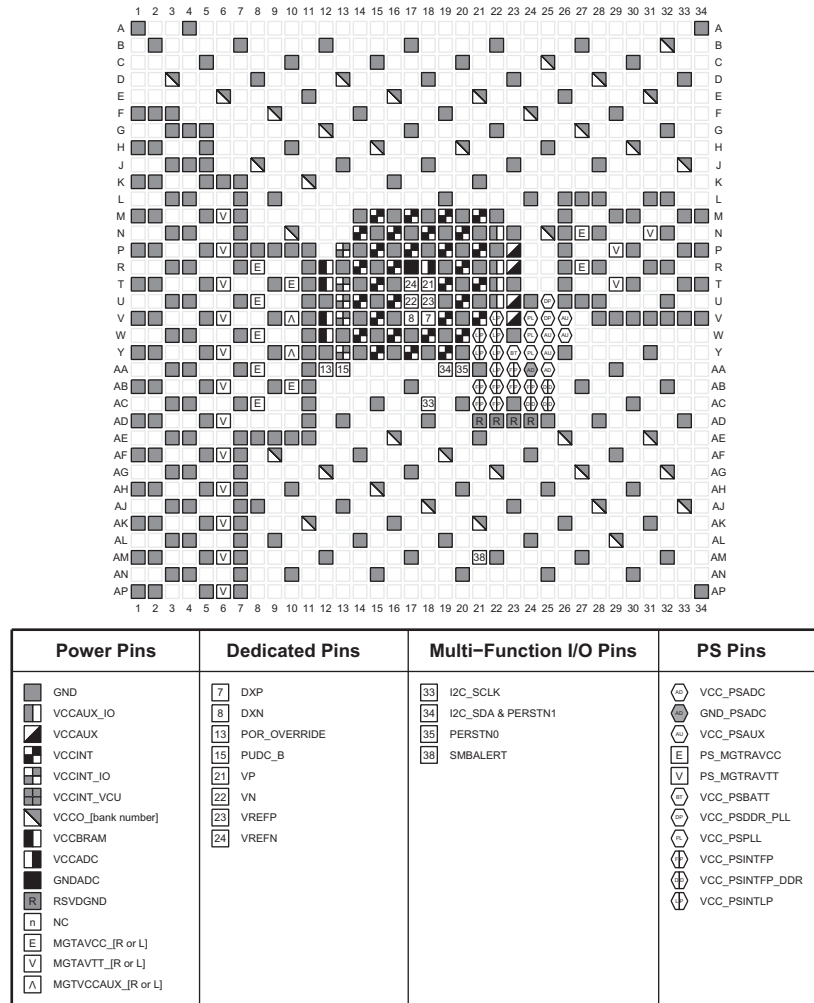

Figure 4-42: FFVC1156 Package—XCZU7CG and XCZU7EG Power, Dedicated, and Multi-function Pin Diagram

FFVC1156 Package—XCZU7EV

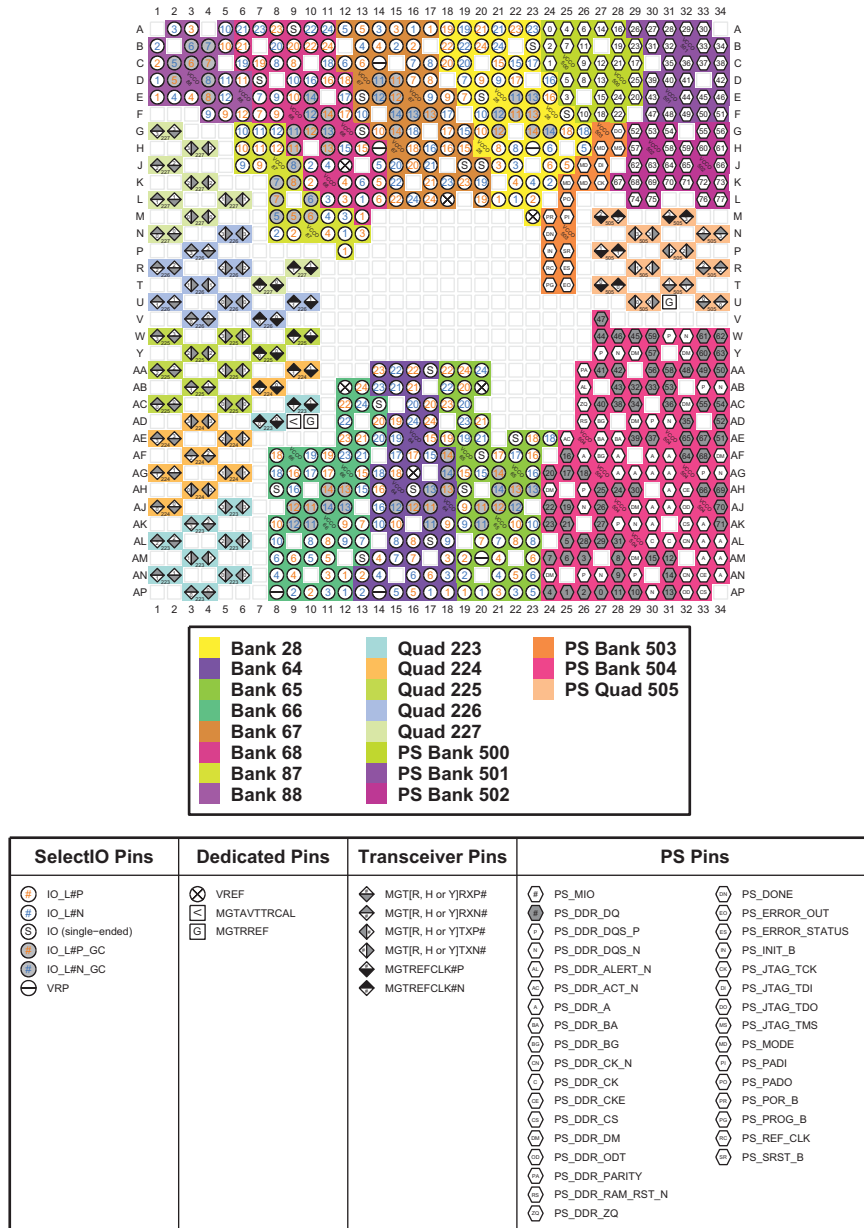

Figure 4-43: FFVC1156 Package—XCZU7EV I/O Bank Diagram

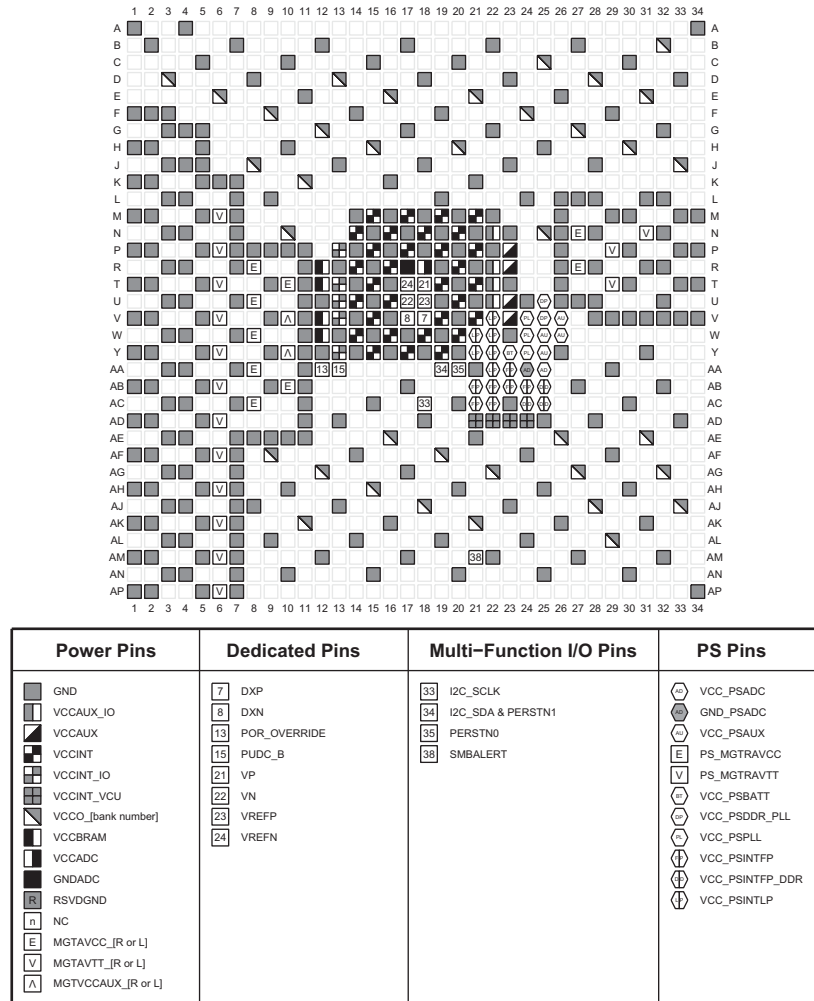

Figure 4-44: FFVC1156 Package—XCZU7EV Power, Dedicated, and Multi-function Pin Diagram

Note: VCCAUX_IO pins for the XQ versions of this device in this package are split into VCCAUX_HPIO and VCCAUX_HDIO. Refer to the package files for VCCAUX_HPIO and VCCAUX_HDIO pin locations.

FFVC1156 Package—XCZU11EG

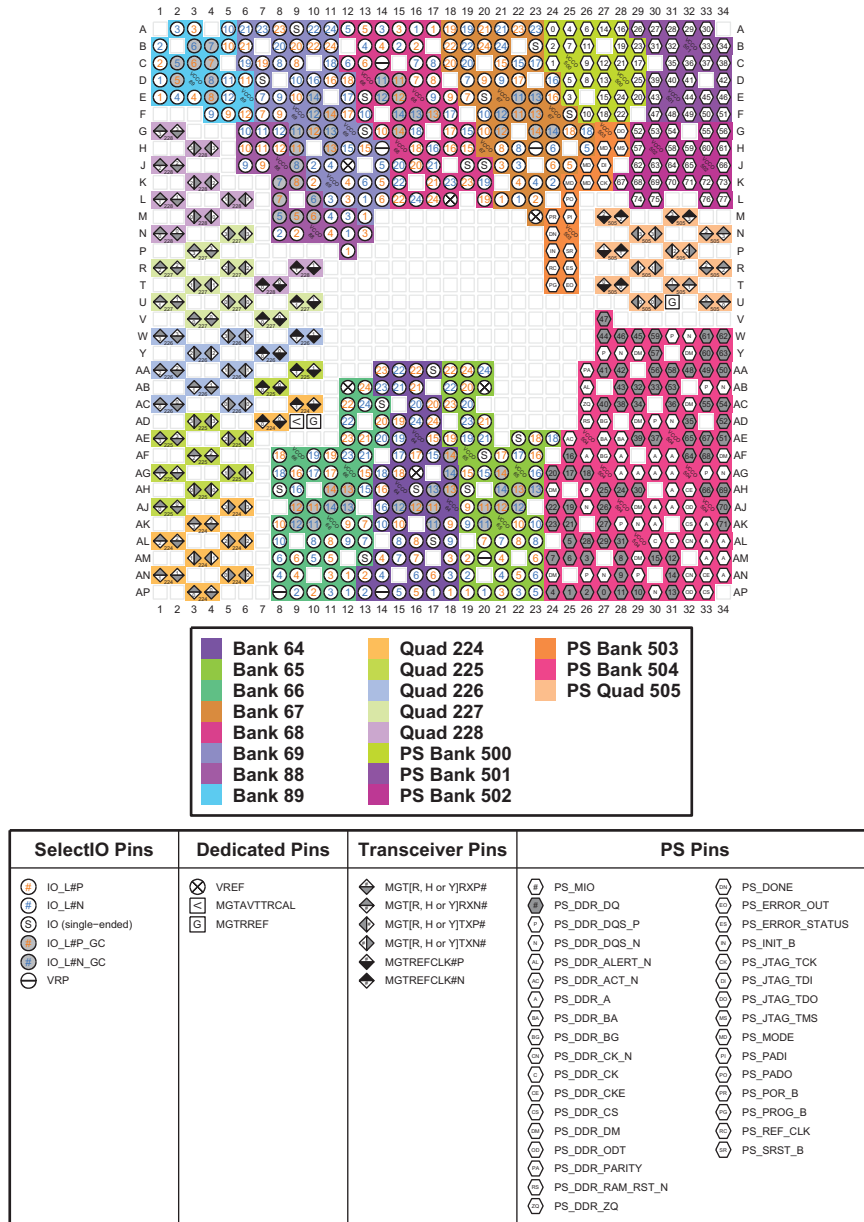

Figure 4-45: FFVC1156 Package—XCZU11EG I/O Bank Diagram

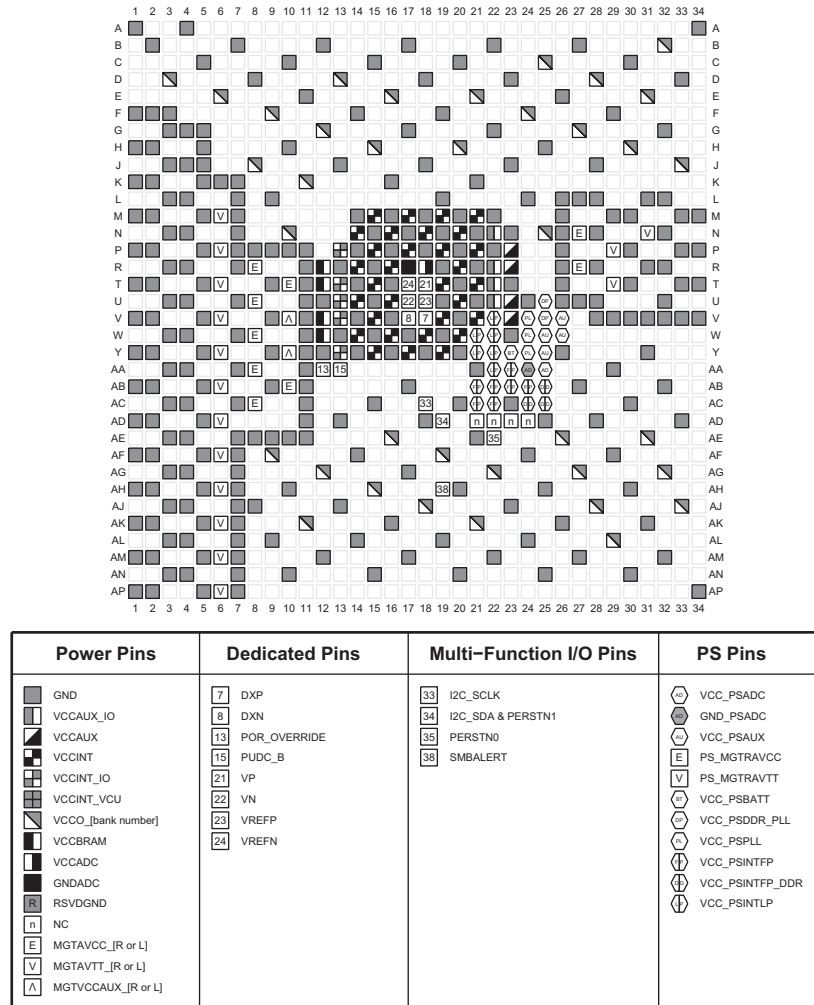

Figure 4-46: FFVC1156 Package—XCZU11EG Power, Dedicated, and Multi-function Pin Diagram

Note: VCCAUX_IO pins for the XQ versions of this device in this package are split into VCCAUX_HPIO and VCCAUX_HDIO. Refer to the package files for VCCAUX_HPIO and VCCAUX_HDIO pin locations.

FFVD1156 Package—XCZU21DR

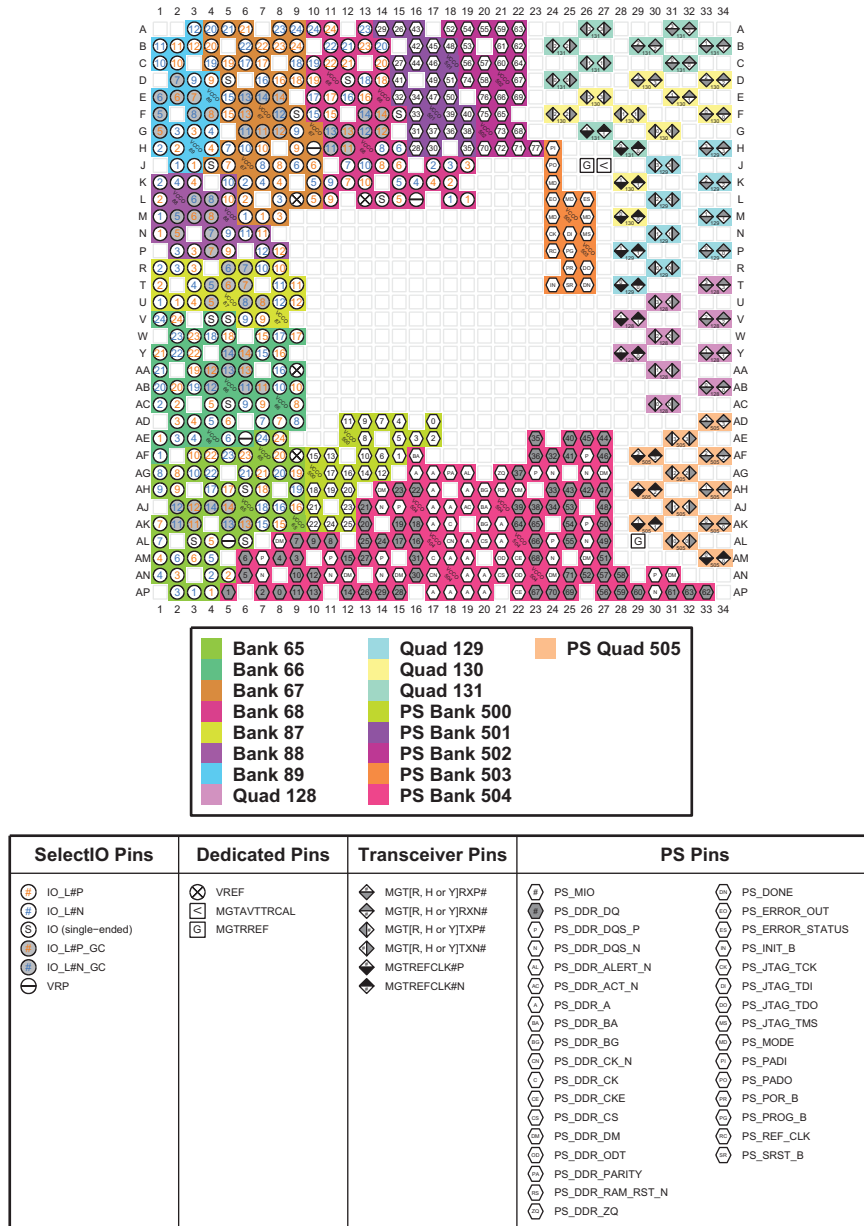

Figure 4-47: FFVD1156 Package—XCZU21DR I/O Bank Diagram

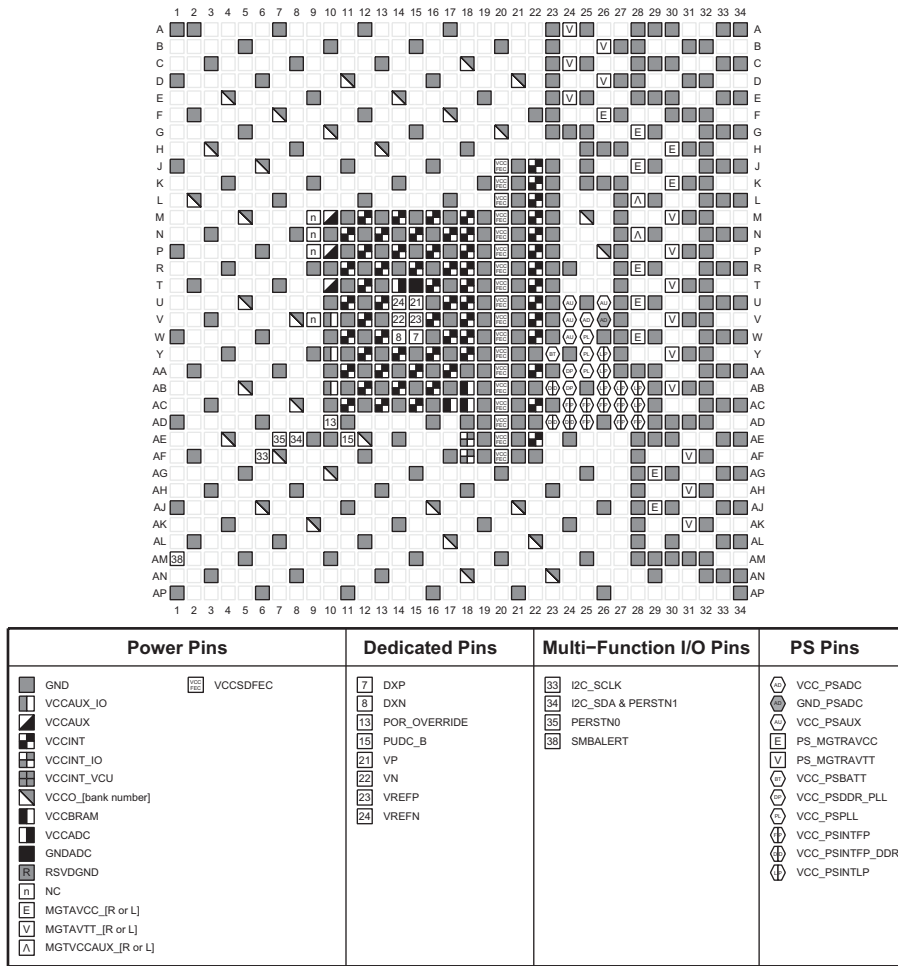

Figure 4-48: FFVD1156 Package—XCZU21DR Power, Dedicated, and Multi-function Pin Diagram

Note: VCCAUX_IO pins for the XQ versions of this device in this package are split into VCCAUX_HPIO and VCCAUX_HDIO. Refer to the package files for VCCAUX_HPIO and VCCAUX_HDIO pin locations.

FFVE1156 and FSVE1156 Packages—XCZU25DR

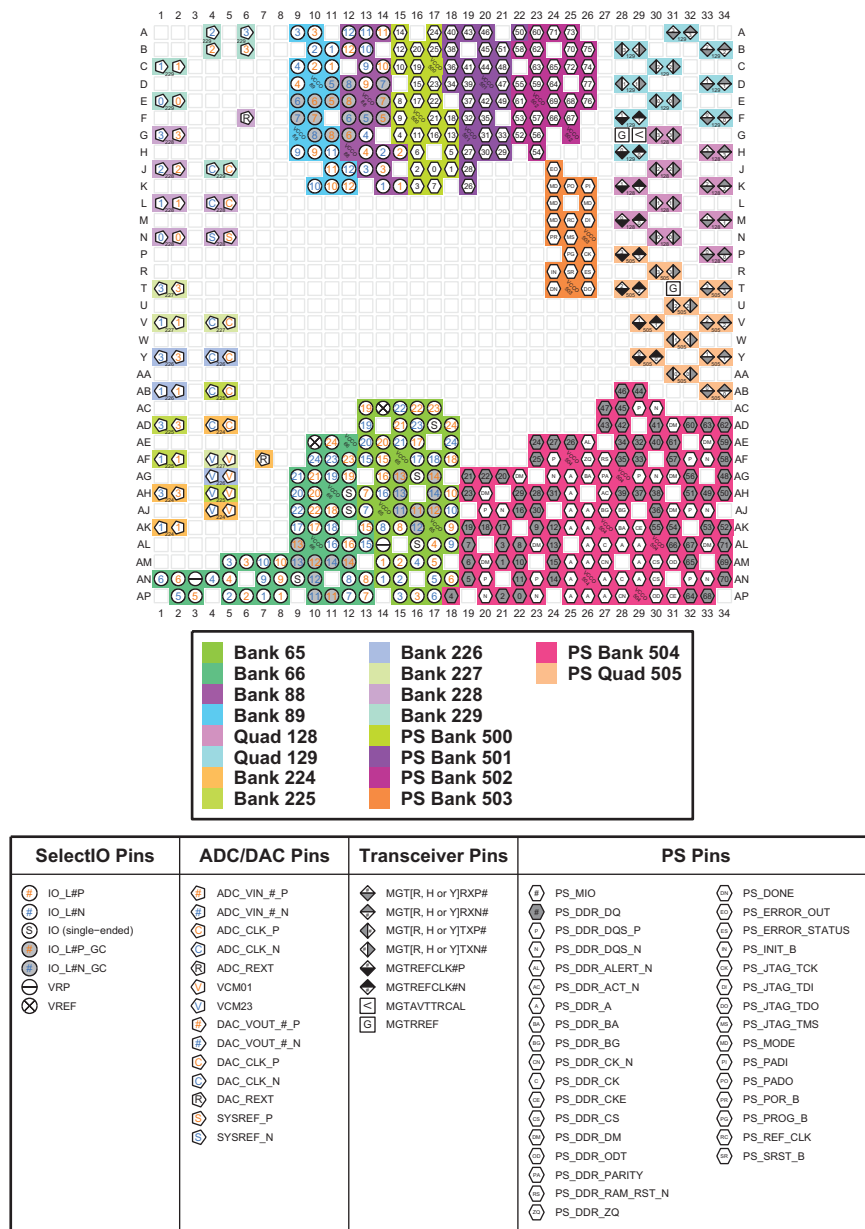

Figure 4-49: FFVE1156 and FSVE1156 Packages—XCZU25DR I/O Bank Diagram

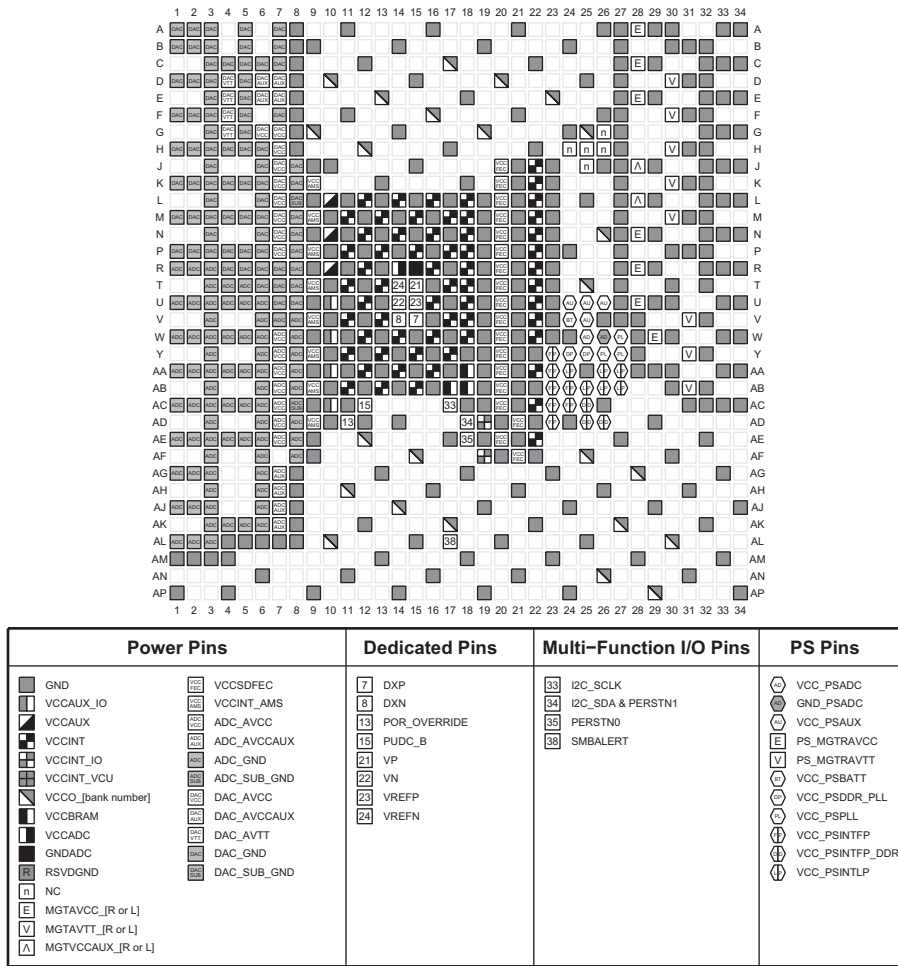

Figure 4-50: FFVE1156 and FSVE1156 Packages—XCZU25DR Power, Dedicated, and Multi-function Pin Diagram

FFVE1156 and FSVE1156 Packages—XCZU27DR and XCZU28DR

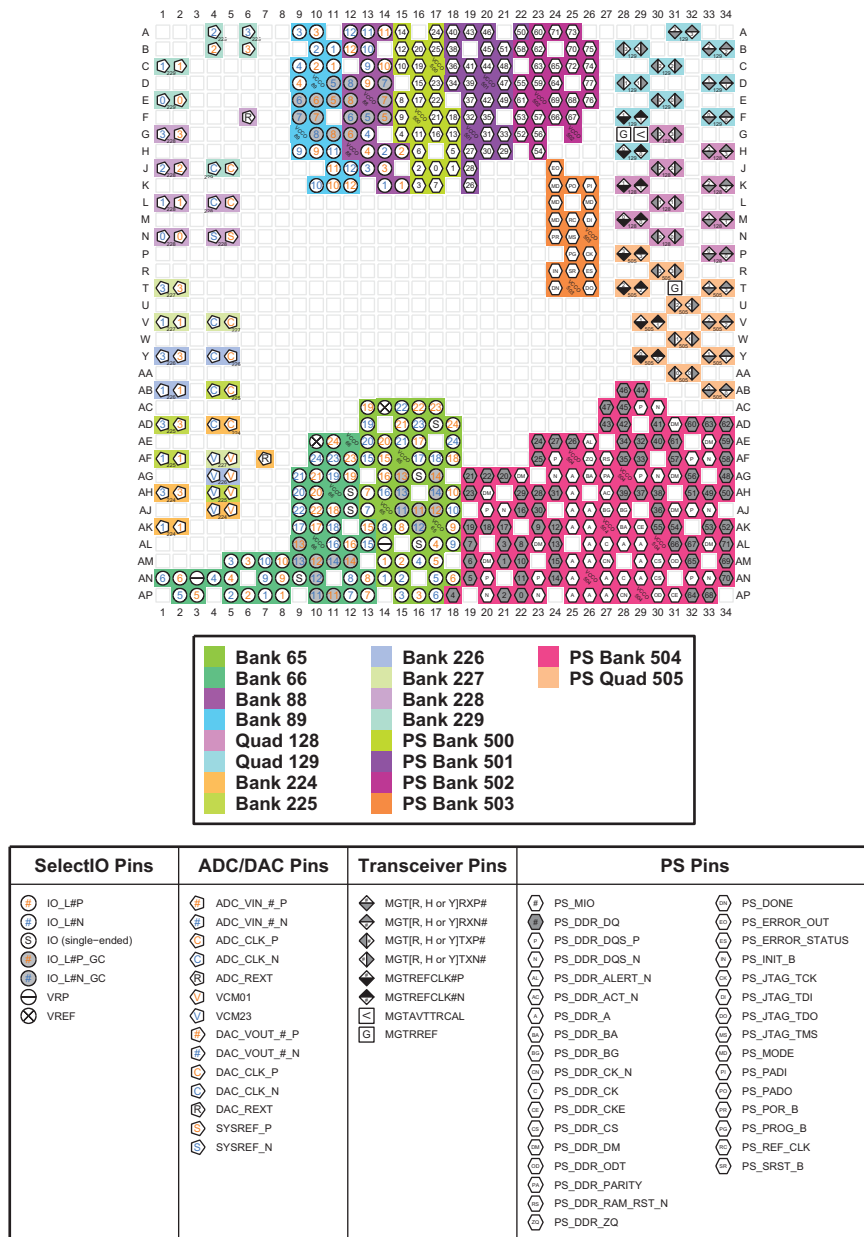

Figure 4-51: FFVE1156 and FSVE1156 Packages—XCZU27DR and XCZU28DR I/O Bank Diagram

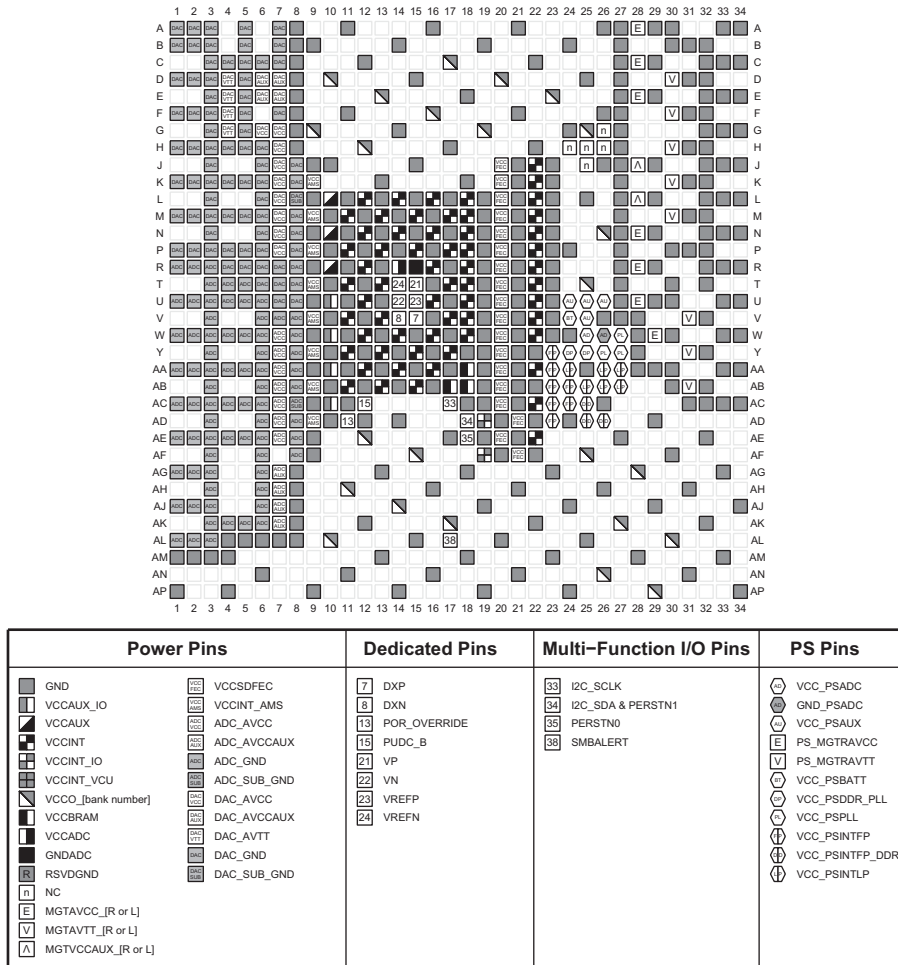

Figure 4-52: FFVE1156 and FSVE1156 Packages—XCZU27DR and XCZU28DR Power, Dedicated, and Multi-function Pin Diagram

Note: VCCAUX_IO pins for the XQ versions of these devices in these packages are split into VCCAUX_HPIO and VCCAUX_HDIO. Refer to the package files for VCCAUX_HPIO and VCCAUX_HDIO pin locations.

FFVE1156 and FSVE1156 Packages—XCZU42DR

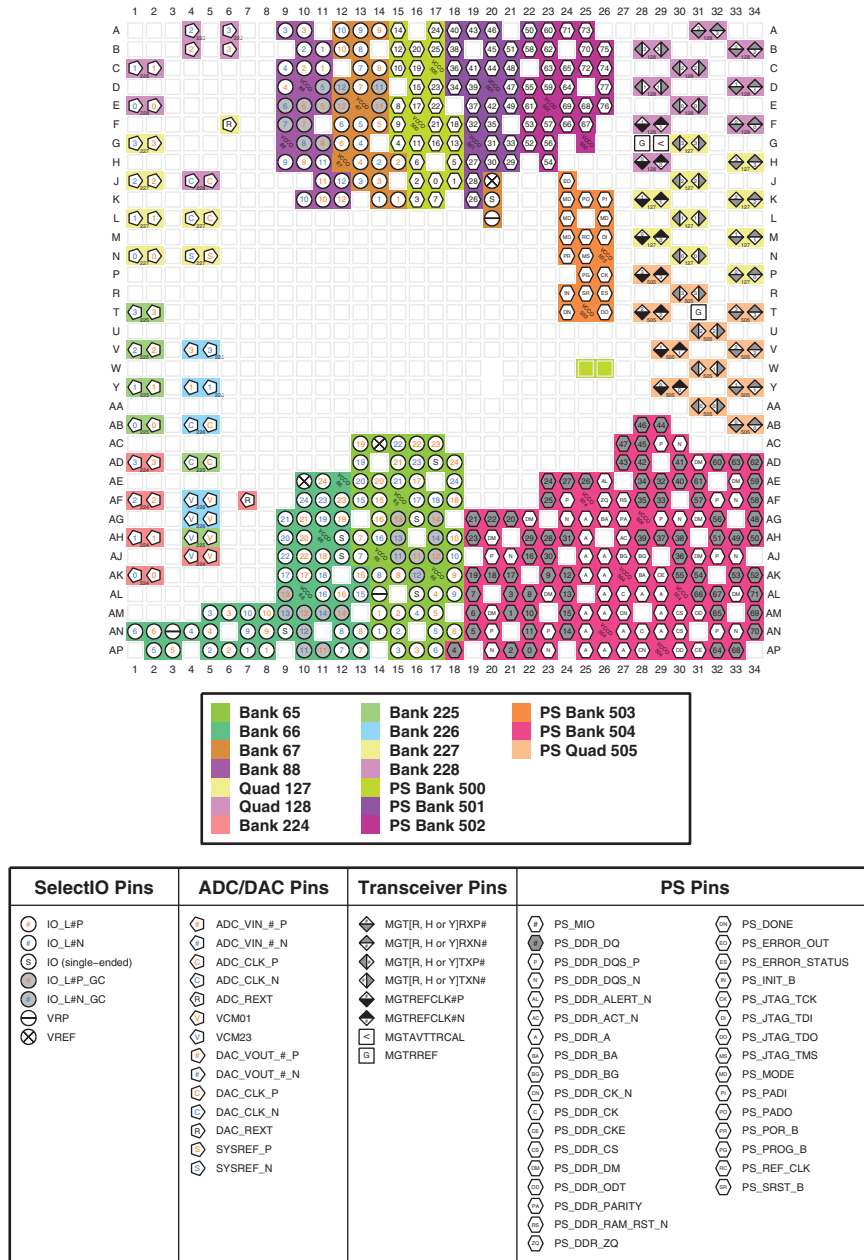
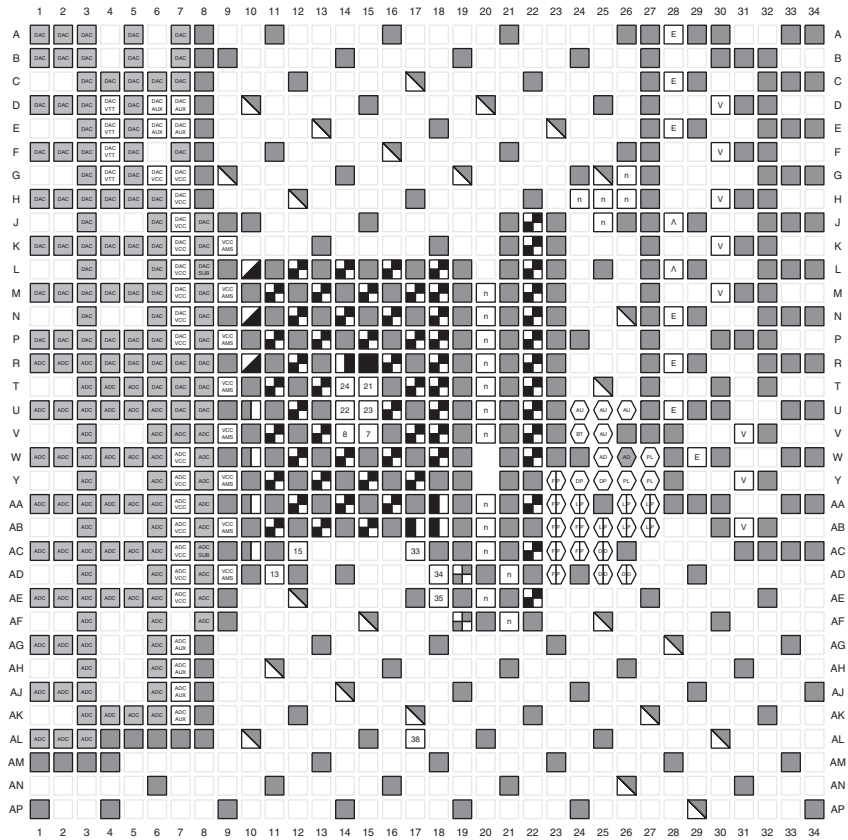

Figure 4-53: FFVE1156 and FSVE1156 Packages—XCZU42DR I/O Bank Diagram



Power Pins		Dedicated Pins	Multi-Function I/O Pins	PS Pins
GND	VCCSDFEC	DXP	I2C_SCLK	VCC_PSADC
VCCAUX_IO	VCCINT_AMS	DXN	I2C_SDA & PERSTN1	GND_PSADC
VCCAUX	ADC_AVCC	POR_OVERRIDE	PERSTN0	VCC_PSAUX
VCCINT	ADC_AVCCAUX	PUDC_B	PERSTN0	PS_MGTRAVCC
VCCINT_IO	ADC_GND	VP	SMBALERT	PS_MGTRAVTT
VCCINT_VCU	ADC_SUB_GND	VN		VCC_PSBATT
VCCO_bank number	DAC_AVCC	VREFP		VCC_PSDDR_PLL
VCCBRAM	DAC_AVCCAUX	VREFN		VCC_PSPLL
VGCADC	DAC_AVTT			VCC_PSINTFP
GNDADC	DAC_GND			VCC_PSINTFP_DDR
RSVD	DAC_SUB_GND			VCC_PSINTLP
RSVDGND	NC			
MGTAUX_IO				
MGTAUX_V				
MGTAUX_A				

Figure 4-54: FFVE1156 and FSVE1156 Packages—XCZU42DR Power, Dedicated, and Multi-function Pin Diagram

FFVE1156 and FSVE1156 Packages—XCZU43DR

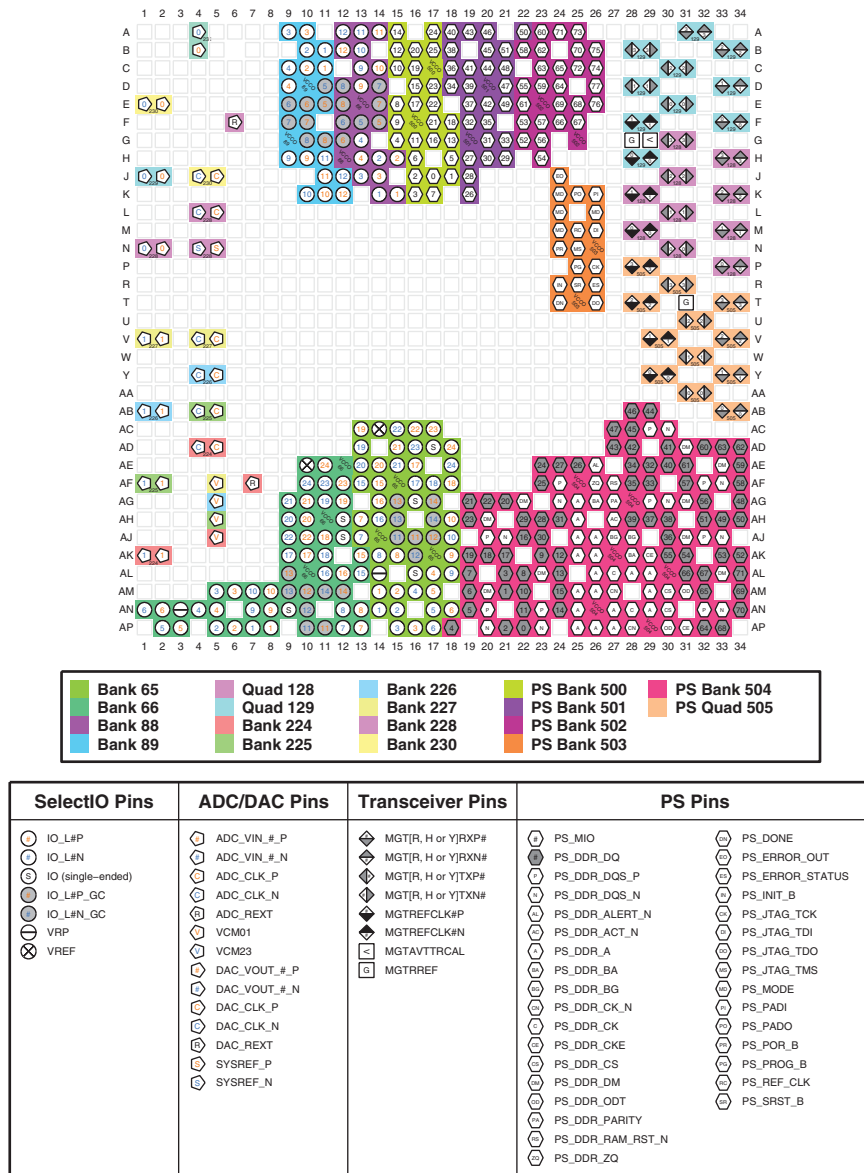

Figure 4-55: FFVE1156 and FSVE1156 Packages—XCZU43DR I/O Bank Diagram

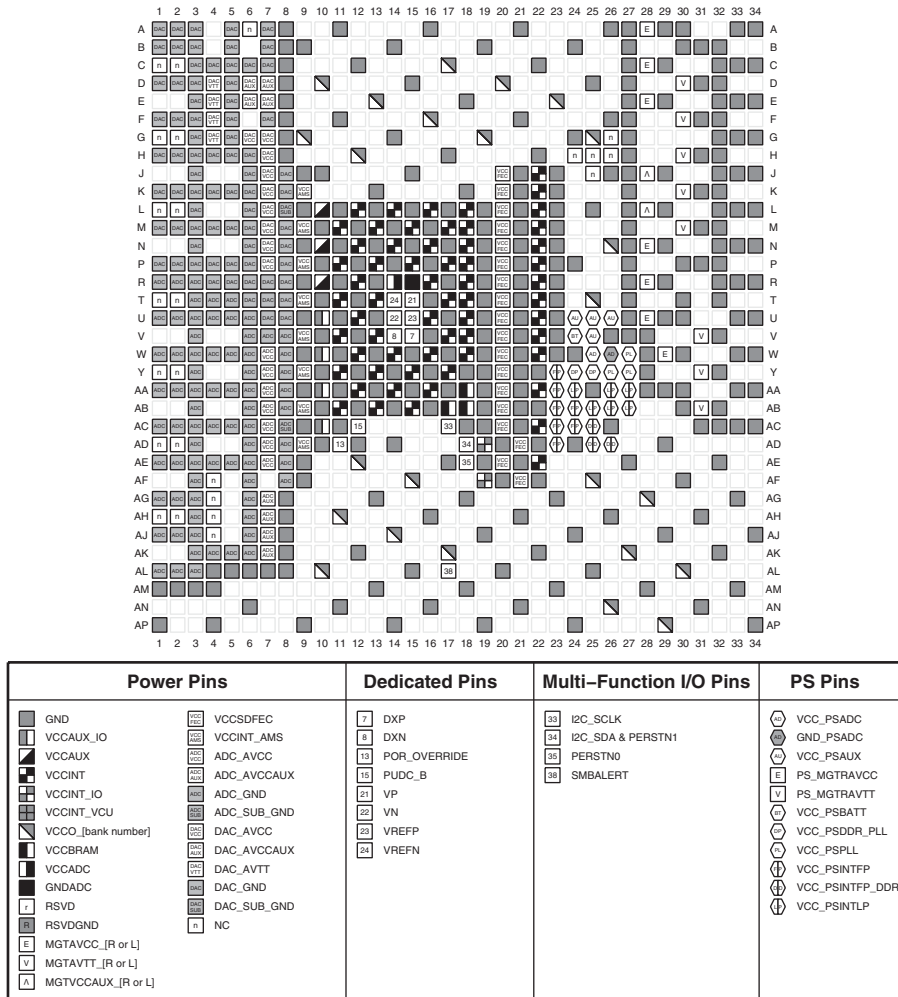

Figure 4-56: FFVE1156 and FSVE1156 Packages—XCZU43DR Power, Dedicated, and Multi-function Pin Diagram

FFVE1156 and FSVE1156 Packages—XCZU47DR

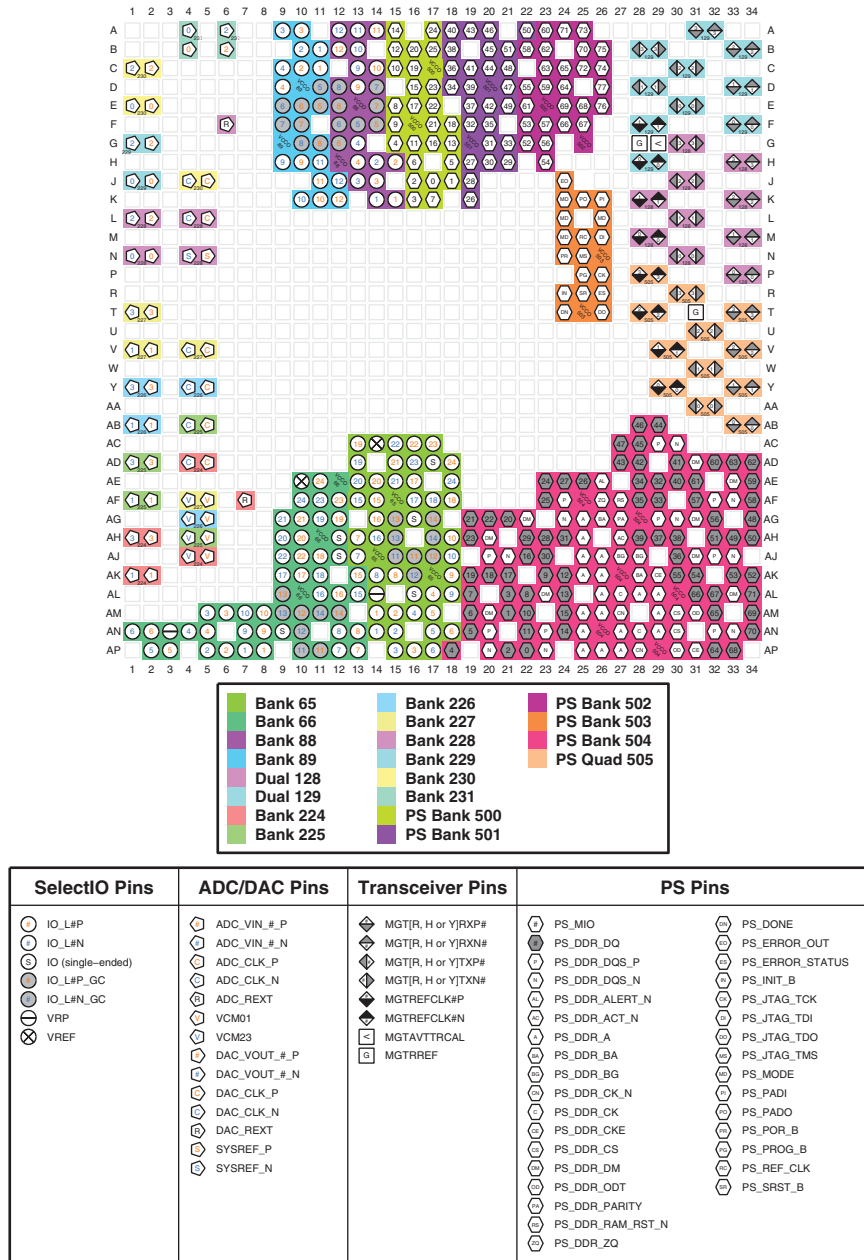
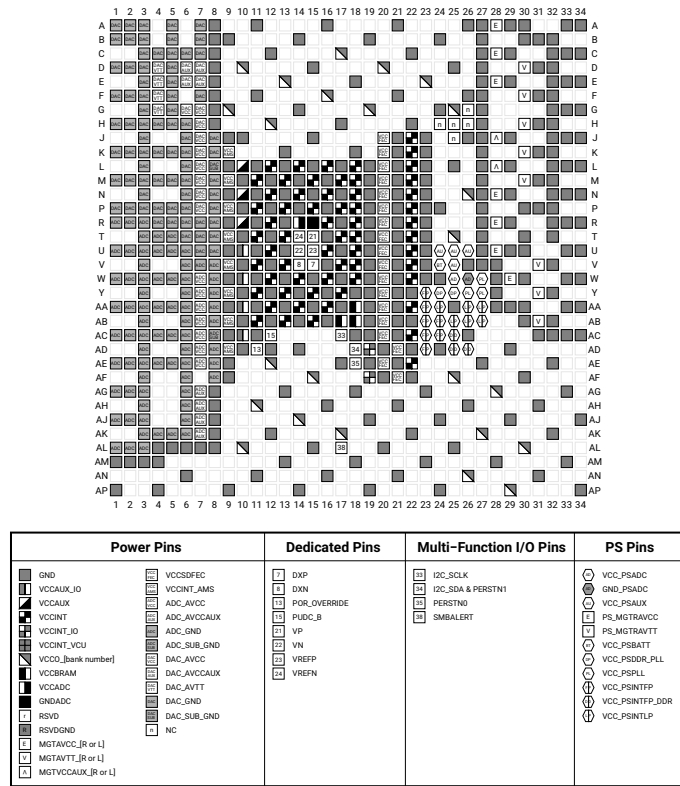

Figure 4-57: FFVE1156 and FSVE1156 Packages—XCZU47DR I/O Bank Diagram



X29465-072224

Figure 4-58: FFVE1156 and FSVE1156 Packages—XCZU47DR Power, Dedicated, and Multi-function Pin Diagram

FFVE1156 and FSVE1156 Packages—XCZU48DR and XQZU48DR

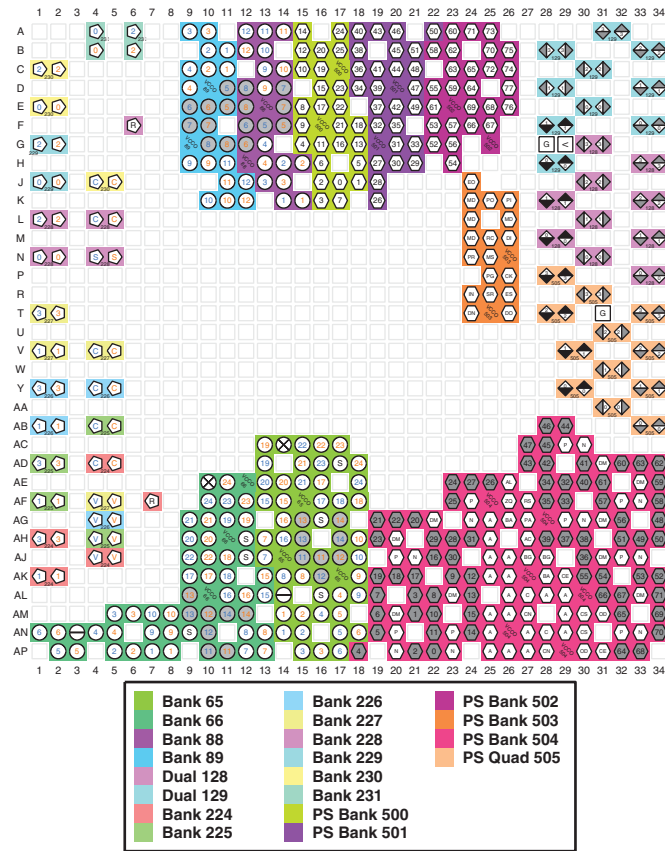

SelectIO Pins	ADC/DAC Pins	Transceiver Pins	PS Pins	
○ IO_L#P	⬡ ADC_VIN_#_P	⬠ MGT[R, H or Y]RX#	⬠ PS_MIO	⬠ PS_DONE
○ IO_L#N	⬡ ADC_VIN_#_N	⬠ MGT[R, H or Y]RXN#	⬠ PS_DDR_DQ	⬠ PS_ERROR_OUT
○ IO (single-ended)	⬡ ADC_CLK_P	⬠ MGT[R, H or Y]TXP#	⬠ PS_DDR_DQS_P	⬠ PS_ERROR_STATUS
○ IO_L#P_GC	⬡ ADC_CLK_N	⬠ MGT[R, H or Y]TXN#	⬠ PS_DDR_DQS_N	⬠ PS_INIT_B
○ IO_L#N_GC	⬡ ADC_REXT	⬠ MGTREFCLK#P	⬠ PS_DDR_ALERT_N	⬠ PS_JTAG_TCK
⊖ VRP	⬡ VCM01	⬠ MGTREFCLK#N	⬠ PS_DDR_ACT_N	⬠ PS_JTAG_TDI
⊗ VREF	⬡ VCM23	⬠ MGTAVTTRCAL	⬠ PS_DDR_A	⬠ PS_JTAG_TDO
	⬡ DAC_VOUT_#_P	⬠ MGTREF	⬠ PS_DDR_BA	⬠ PS_JTAG_TMS
	⬡ DAC_VOUT_#_N		⬠ PS_DDR_BG	⬠ PS_MODE
	⬡ DAC_CLK_P		⬠ PS_DDR_CK_N	⬠ PS_PADI
	⬡ DAC_CLK_N		⬠ PS_DDR_CK	⬠ PS_PADO
	⬡ DAC_REXT		⬠ PS_DDR_CKE	⬠ PS_POR_B
	⬡ SYSREF_P		⬠ PS_DDR_CS	⬠ PS_PROG_B
	⬡ SYSREF_N		⬠ PS_DDR_DM	⬠ PS_REF_CLK
			⬠ PS_DDR_ODT	⬠ PS_SRST_B
			⬠ PS_DDR_PARITY	
			⬠ PS_DDR_RAM_RST_N	
			⬠ PS_DDR_ZQ	

Figure 4-59: FFVE1156 and FSVE1156 Packages—XCZU48DR and XQZU48DR I/O Bank Diagram

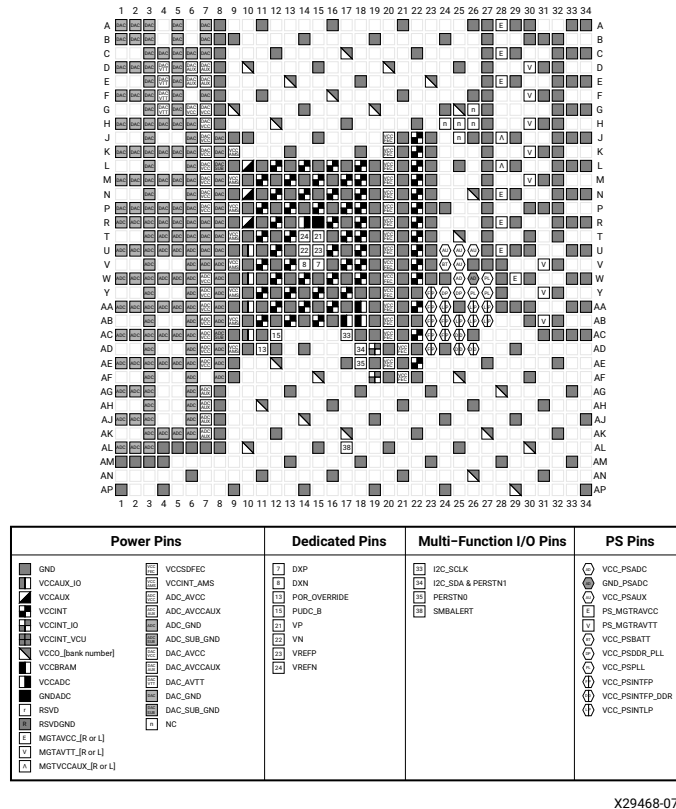

X29468-072424

Figure 4-60: FFVE1156 and FSVE1156 Packages—XCZU48DR and XQZU48DR Power, Dedicated, and Multi-function Pin Diagram

Note: VCCAUX_IO pins for the XQ versions of these devices in these packages are split into VCCAUX_HPIO and VCCAUX_HDIO. Refer to the package files for VCCAUX_HPIO and VCCAUX_HDIO pin locations.

FFVE1156 and FSVE1156 Packages—XCZU63DR

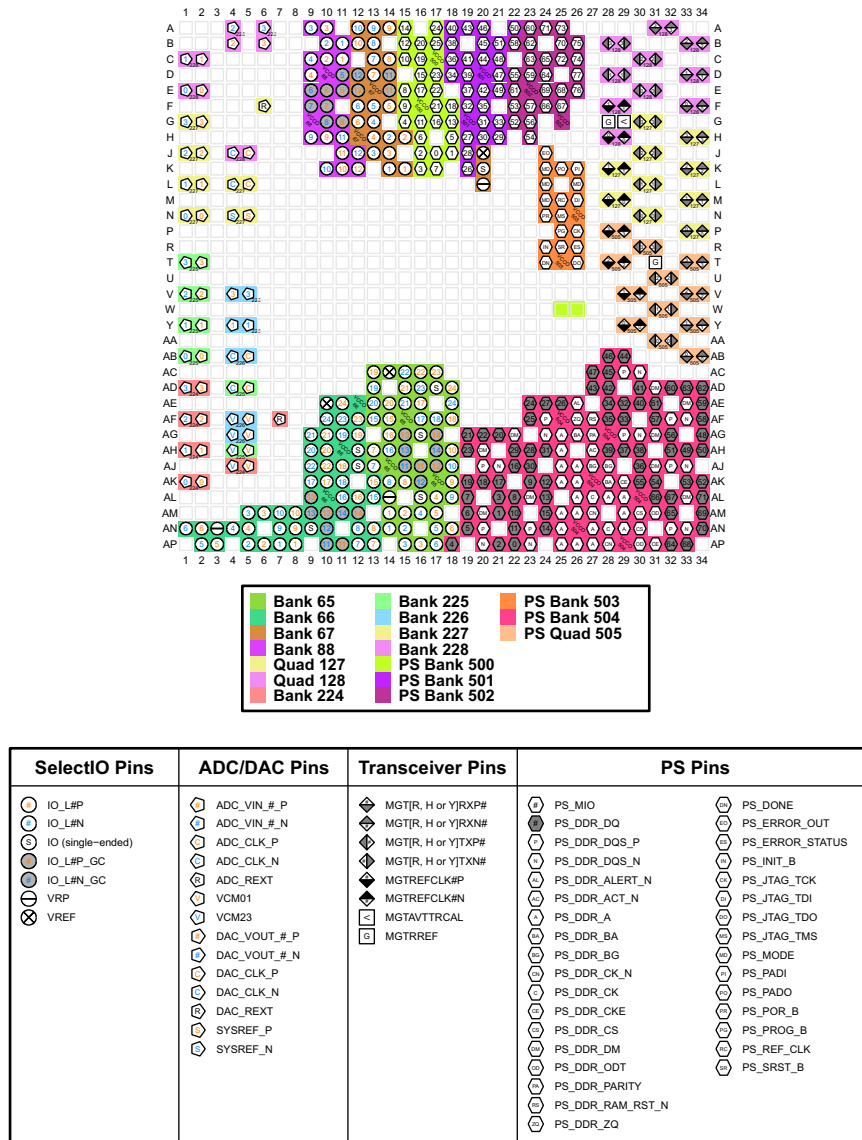
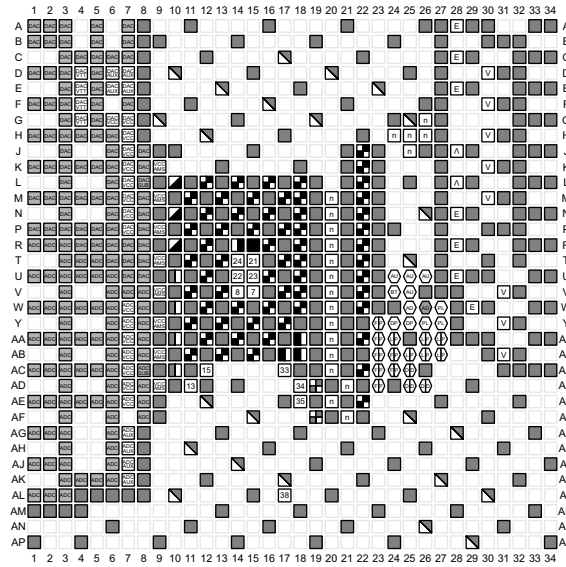

Figure 4-61: FFVE1156 and FSVE1156 Packages—XCZU63DR I/O Bank Diagram



Power Pins		Dedicated Pins	Multi-Function I/O Pins	PS Pins
GND	VCCDFEC	DXP	I2C_SCLK	VCC_PSADC
VCCAUX_IO	VCCINT_AMS	DXN	I2C_SDA & PERSTN1	GND_PSADC
VCCAUX	ADC_AVCC	POR_OVERRIDE	PERSTN0	VCC_PSAUX
VCCINT	ADC_AVCCAUX	PUDC_B	SMBALERT	PS_MGTRAVCC
VCCINT_IO	ADC_GND	VP		PS_MGTRAVTT
VCCINT_VCU	ADC_SUB_GND	VN		VCC_PSBATT
VCCO_[bank number]	DAC_AVCC	VREFP		VCC_PSDDR_PLL
VCCBRAM	DAC_AVCCAUX	VREFN		VCC_PSPLL
VCCADC	DAC_AVTT			VCC_PSINTFP
GNDADC	DAC_GND			VCC_PSINTFP_DDR
RSVD	DAC_SUB_GND			VCC_PSINTLP
RSVDGND	NC			
MGTAUX_[R or L]				
MGTAVT_[R or L]				
MGTVCCAUX_[R or L]				

Figure 4-62: FFVE1156 and FSVE1156 Packages—XCZU63DR Power, Dedicated, and Multi-function Pin Diagram

FFVE1156 and FSVE1156 Packages—XCZU64DR

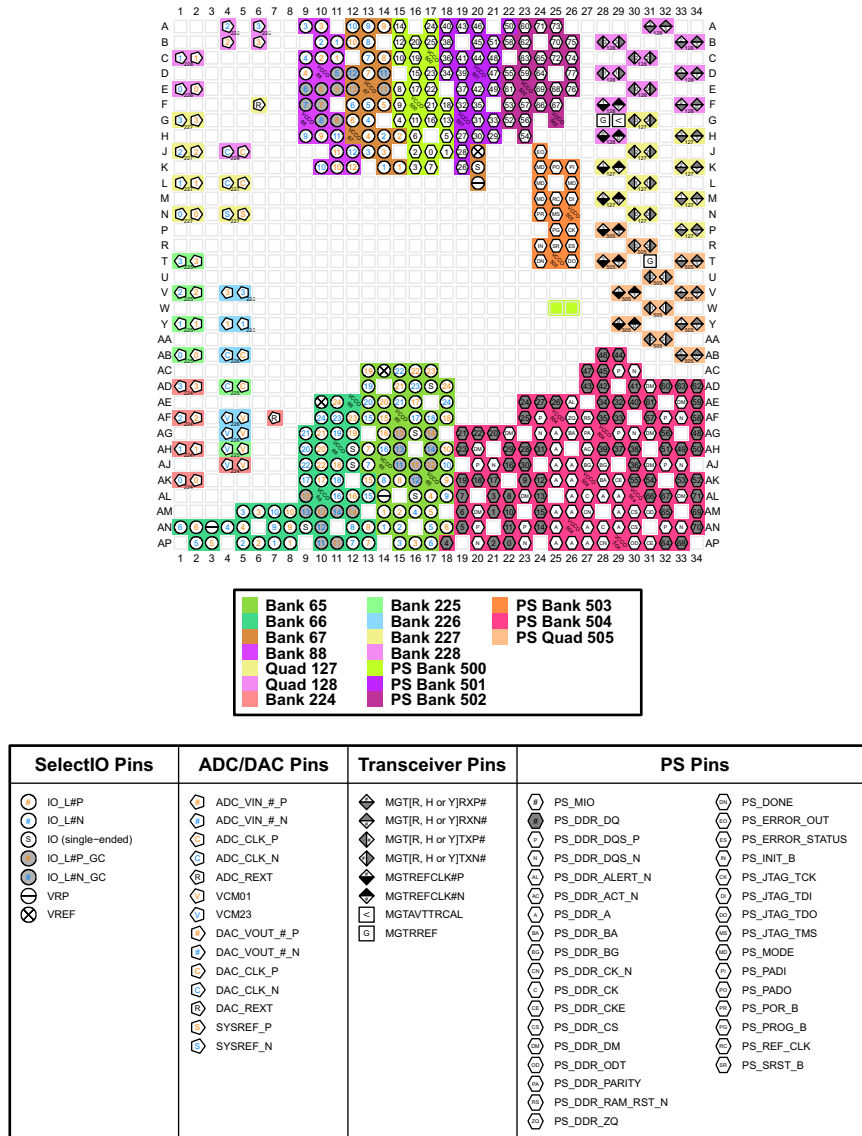
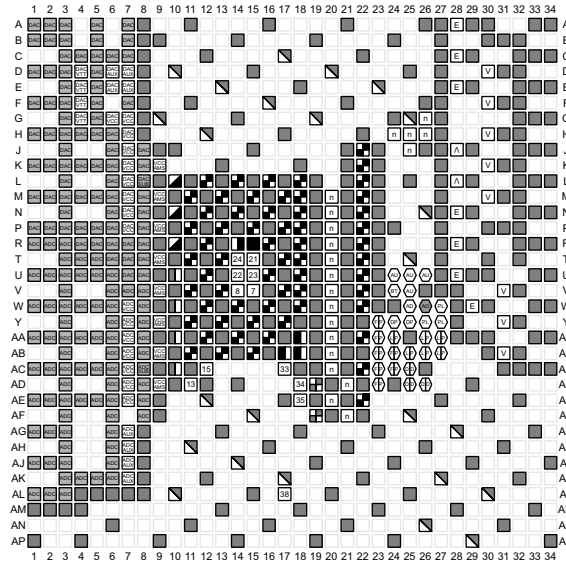

Figure 4-63: FFVE1156 and FSVE1156 Packages—XCZU64DR I/O Bank Diagram



Power Pins		Dedicated Pins	Multi-Function I/O Pins	PS Pins
GND	VCCDFEC	DXP	I2C_SCLK	VCC_PSADC
VCCAUX_IO	VCCINT_AMS	DXN	I2C_SDA & PERSTN1	GND_PSADC
VCCAUX	ADC_AVCC	POR_OVERRIDE	PERSTN0	VCC_PSAUX
VCCINT	ADC_AVCCAUX	PUDC_B	SMBALERT	PS_MGTRAVCC
VCCINT_IO	ADC_GND	VP		PS_MGTRAVTT
VCCINT_VCU	ADC_SUB_GND	VN		VCC_PSBATT
VCCO_[bank number]	DAC_AVCC	VREFP		VCC_PSDDR_PLL
VCCBRAM	DAC_AVCCAUX	VREFN		VCC_PSPLL
VCCADC	DAC_AVTT			VCC_PSINTFP
GNDADC	DAC_GND			VCC_PSINTFP_DDR
RSVD	DAC_SUB_GND			VCC_PSINTLP
RSVDGND	NC			
MGTAVCC_[R or L]				
MGTAVTT_[R or L]				
MGTVCCAUX_[R or L]				

Figure 4-64: FFVE1156 and FSVE1156 Packages—XCZU64DR Power, Dedicated, and Multi-function Pin Diagram

FFVE1156 and FSVE1156 Packages—XCZU65DR

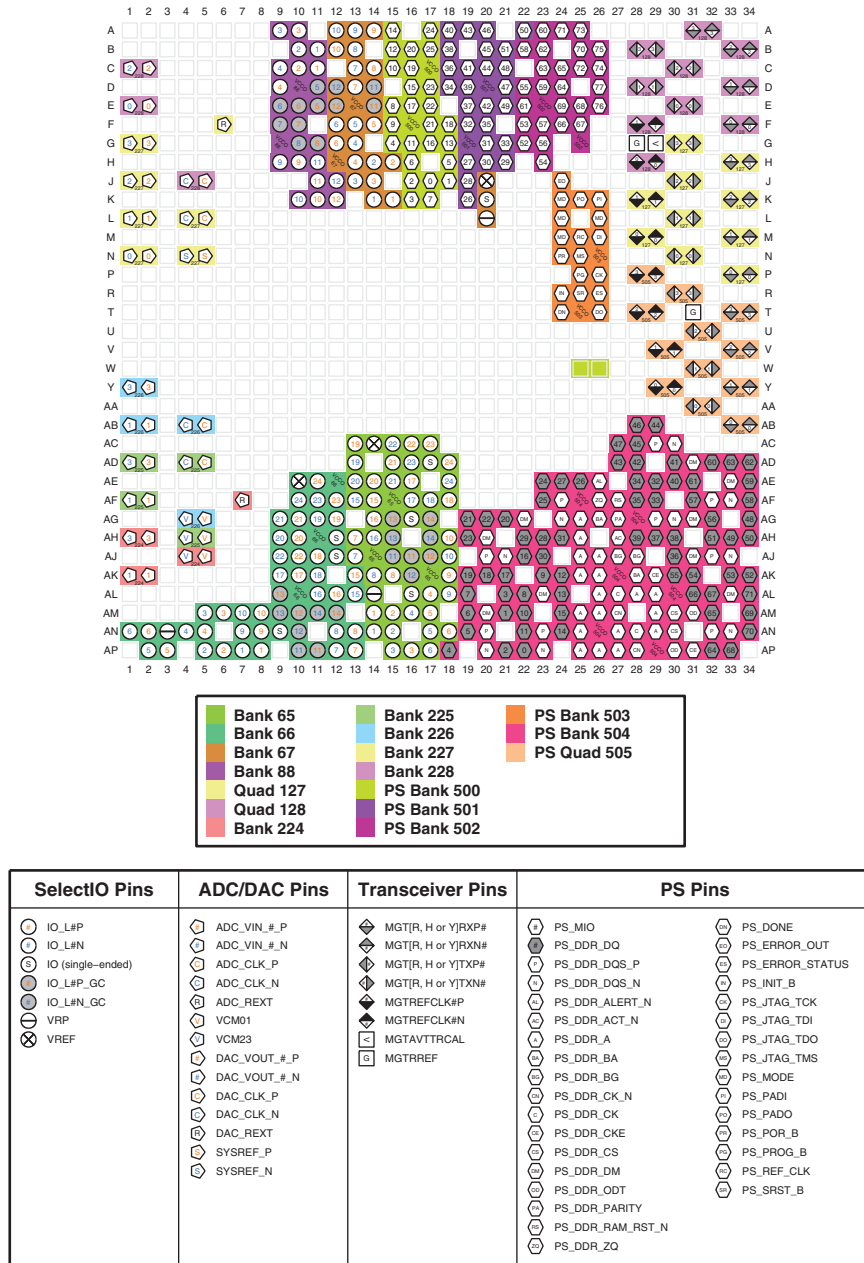

Figure 4-65: FFVE1156 and FSVE1156 Packages—XCZU65DR I/O Bank Diagram

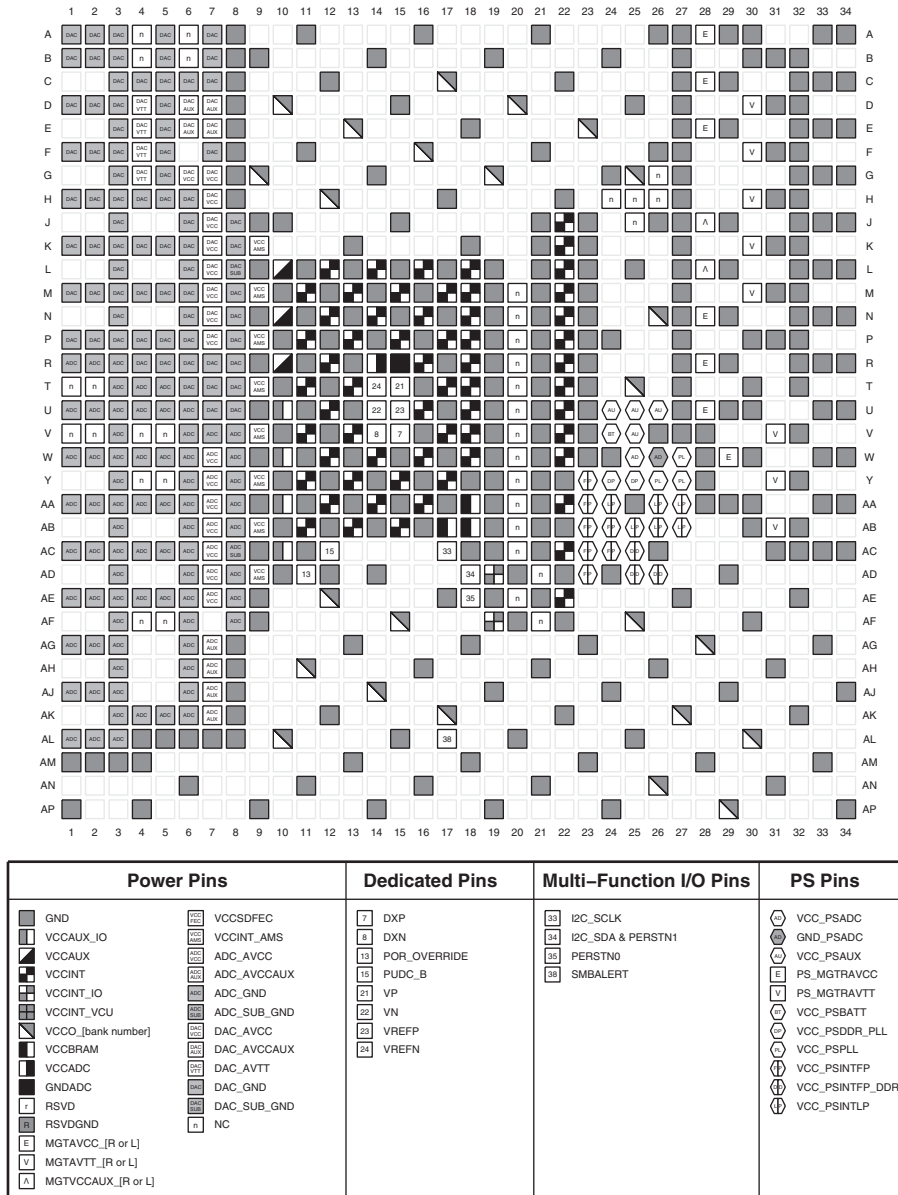

Figure 4-66: FFVE1156 and FSVE1156 Packages—XCZU65DR Power, Dedicated, and Multi-function Pin Diagram

FFVE1156 and FSVE1156 Packages—XCZU67DR

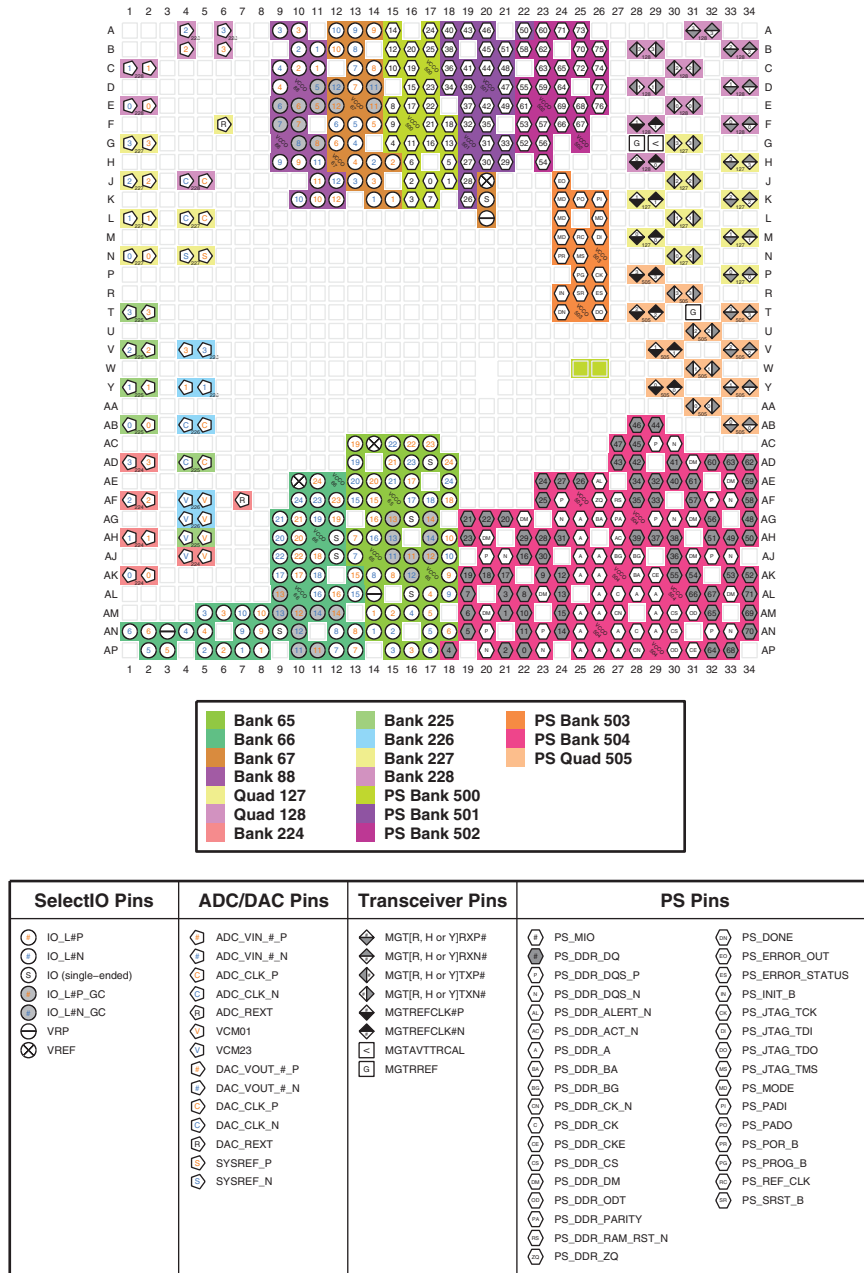

Figure 4-67: FFVE1156 and FSVE1156 Packages—XCZU67DR I/O Bank Diagram

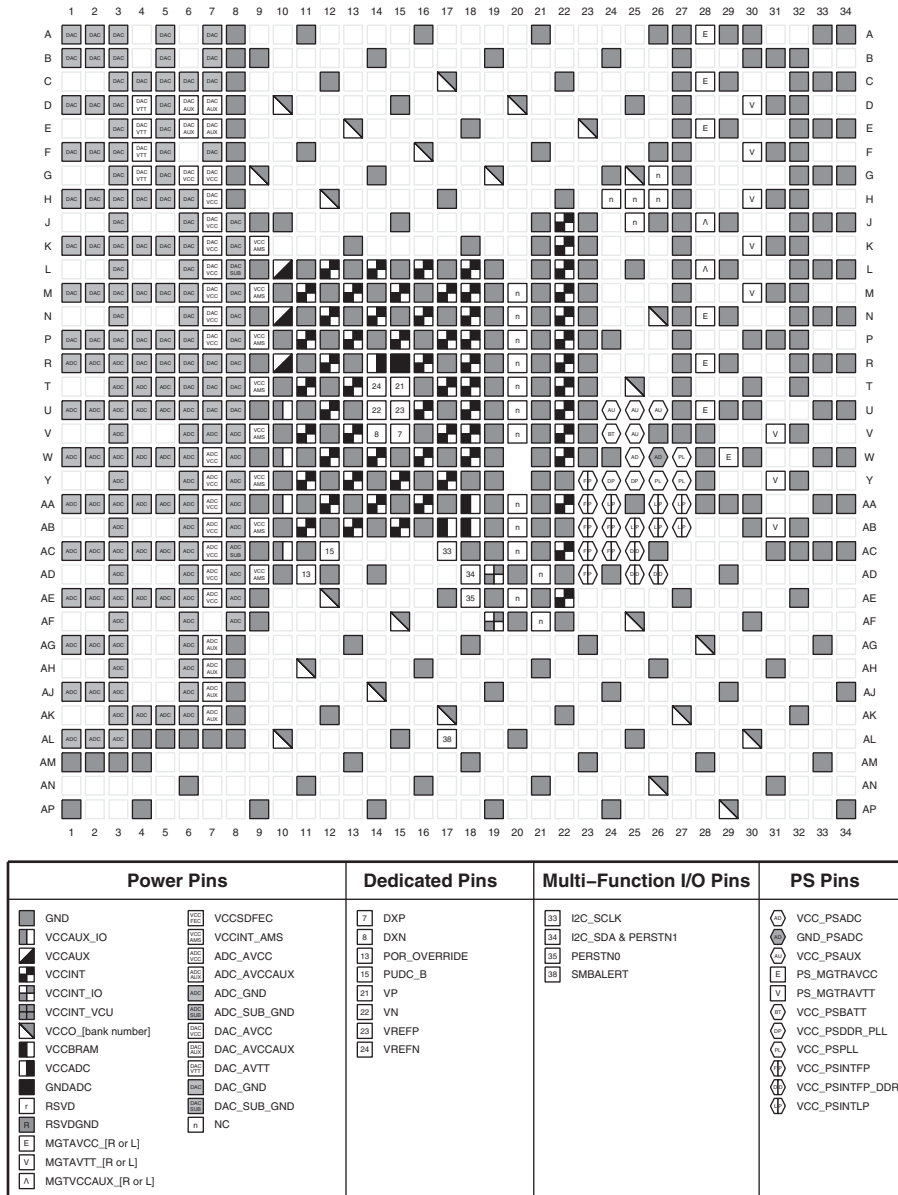

Figure 4-68: FFVE1156 and FSVE1156 Packages—XCZU67DR Power, Dedicated, and Multi-function Pin Diagram

FFVB1517 Package—XCZU11EG

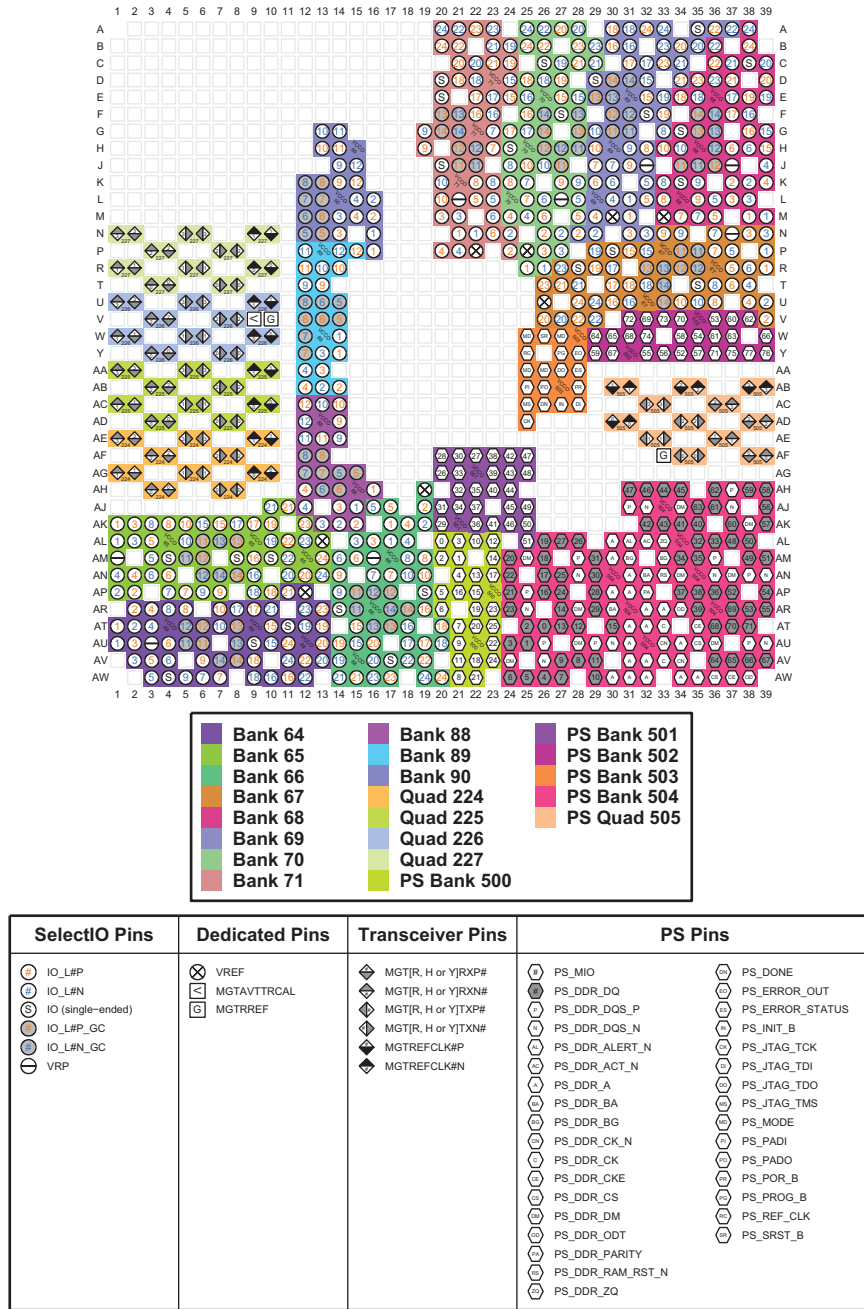
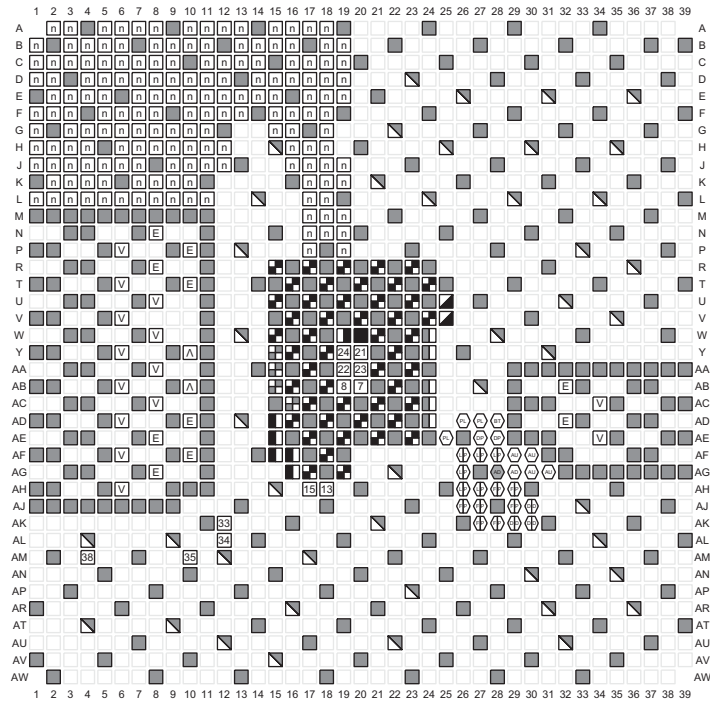

Figure 4-69: FFVB1517 Package—XCZU11EG I/O Bank Diagram



Power Pins	Dedicated Pins	Multi-Function I/O Pins	PS Pins
GND	7 DXP	33 I2C_SCLK	VCC_PSADC
VCCAUX_IO	8 DXN	34 I2C_SDA & PERSTN1	GND_PSADC
VCCAUX	13 POR_OVERRIDE	35 PERSTN0	VCC_PSAUX
VCCINT	15 PUDC_B	38 SMBALERT	PS_MGTRAVCC
VCCINT_IO	21 VP		PS_MGTRAVTT
VCCINT_VCU	22 VN		VCC_PSBATT
VCCO_[bank number]	23 VREFP		VCC_PSDDR_PLL
VCCBRAM	24 VREFN		VCC_PSPLL
VCCADC			VCC_PSINTFP
GNDADC			VCC_PSINTFP_DDR
RSVDGND			VCC_PSINTLP
NC			
MGTAVCC_[R or L]			
MGTA_VTT_[R or L]			
MGTVCCAUX_[R or L]			

Figure 4-70: FFVB1517 Package—XCZU11EG Power, Dedicated, and Multi-function Pin Diagram

FFVB1517 Package—XCZU17EG and XCZU19EG

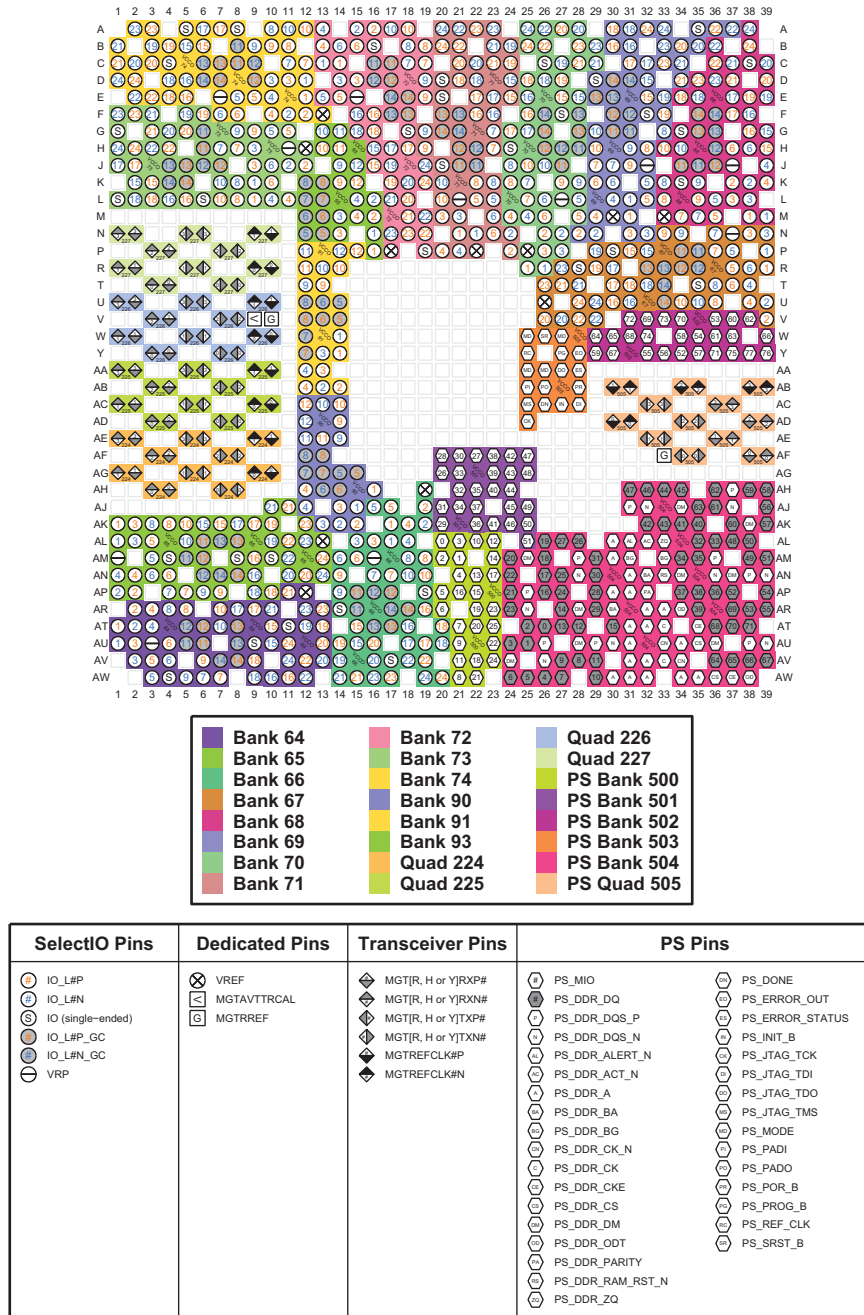

Figure 4-71: FFVB1517 Package—XCZU17EG and XCZU19EG I/O Bank Diagram

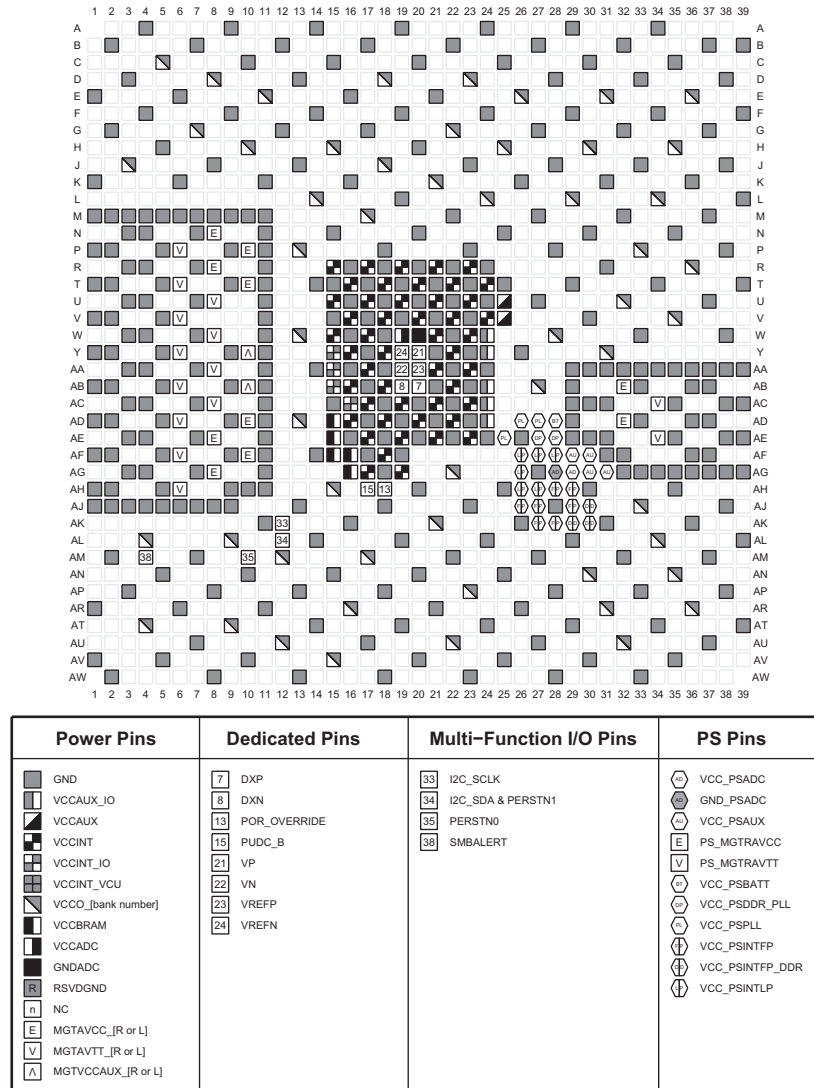

Figure 4-72: FFVB1517 Package—XCZU17EG and XCZU19EG Power, Dedicated, and Multi-function Pin Diagram

Note: VCCAUX_IO pins for the XQ versions of these devices in this package are split into VCCAUX_HPIO and VCCAUX_HDIO. Refer to the package files for VCCAUX_HPIO and VCCAUX_HDIO pin locations.

FFVF1517 Package—XCZU7CG and XCZU7EG

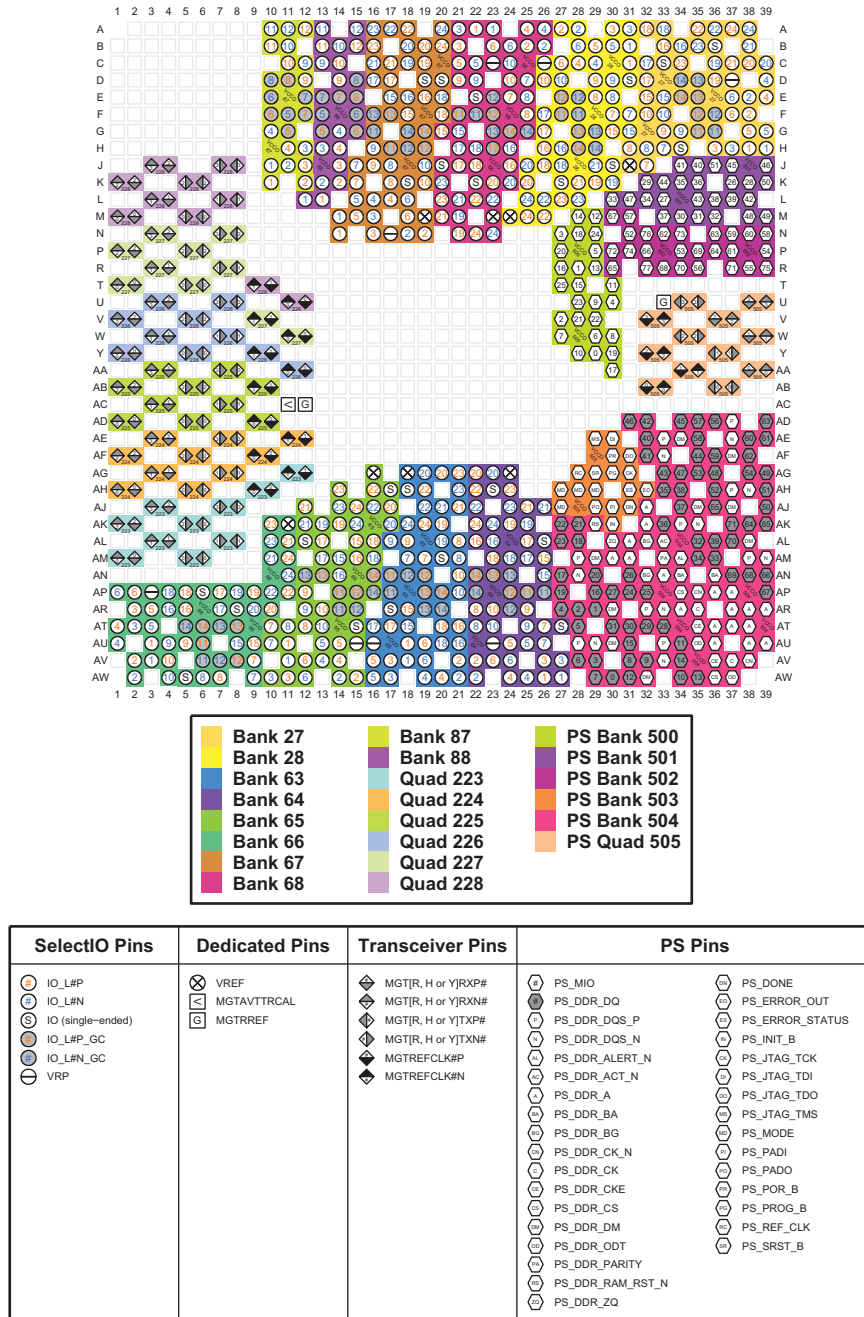
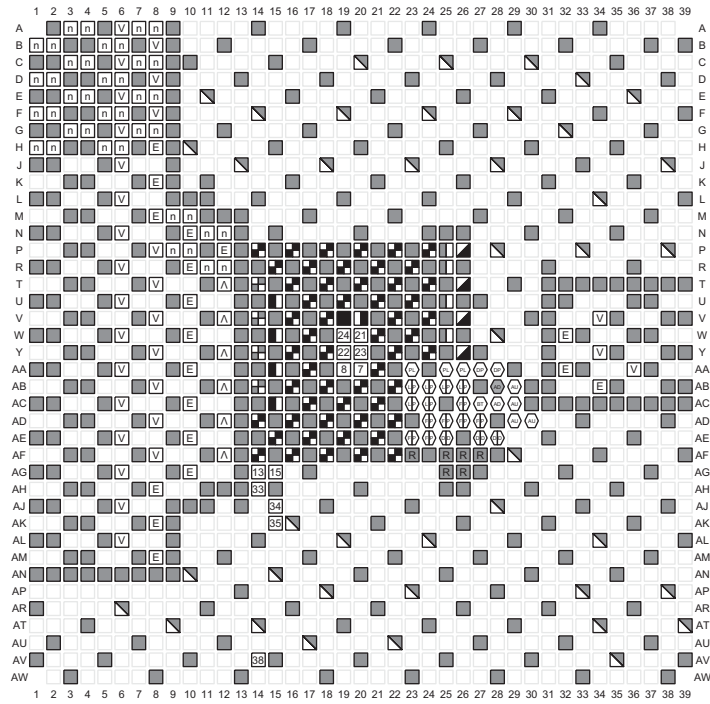

Figure 4-73: FFVF1517 Package—XCZU7CG and XCZU7EG I/O Bank Diagram



Power Pins	Dedicated Pins	Multi-Function I/O Pins	PS Pins
<ul style="list-style-type: none"> GND VCCAUX_IO VCCAUX VCCINT VCCINT_IO VCCINT_VCU VCCO_{bank number} VCCBRAM VCCADC GNDADC RSVDGND NC MGTAVCC_{R or L} MGTAVTT_{R or L} MGTVCCAUX_{R or L} 	<ul style="list-style-type: none"> DXP DXN POR_OVERRIDE PUDC_B VP VN VREFP VREFN 	<ul style="list-style-type: none"> I2C_SCLK I2C_SDA & PERSTN1 PERSTN0 SMBALERT 	<ul style="list-style-type: none"> VCC_PSADC GND_PSADC VCC_PSAUX PS_MGTRAVCC PS_MGTRAVTT VCC_PSBATT VCC_PSDDR_PLL VCC_PSPLL VCC_PSINTFP VCC_PSINTFP_DDR VCC_PSINTLP

Figure 4-74: FFVF1517 Package—XCZU7CG and XCZU7EG Power, Dedicated, and Multi-function Pin Diagram

FFVF1517 Package—XCZU7EV

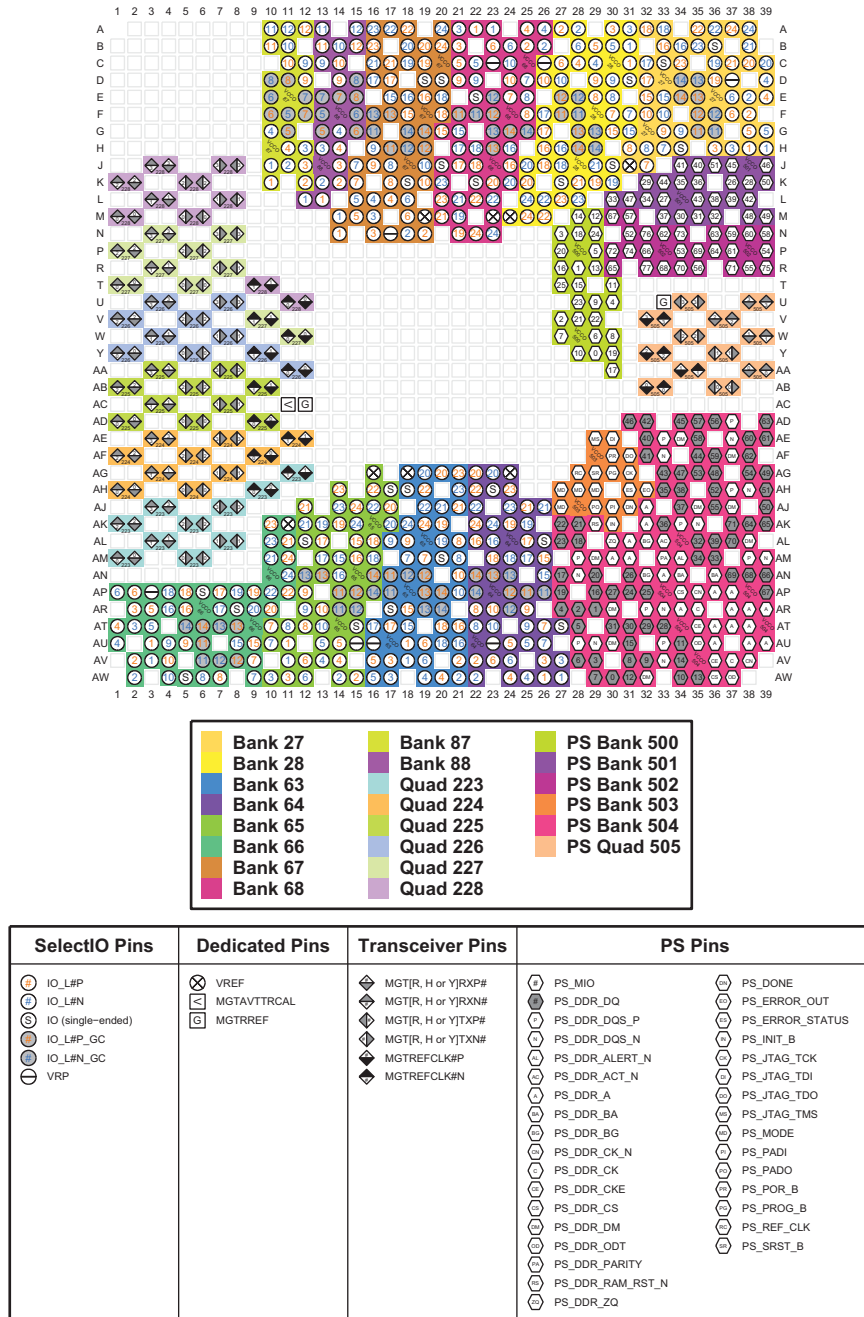

Figure 4-75: FFVF1517 Package—XCZU7EV I/O Bank Diagram

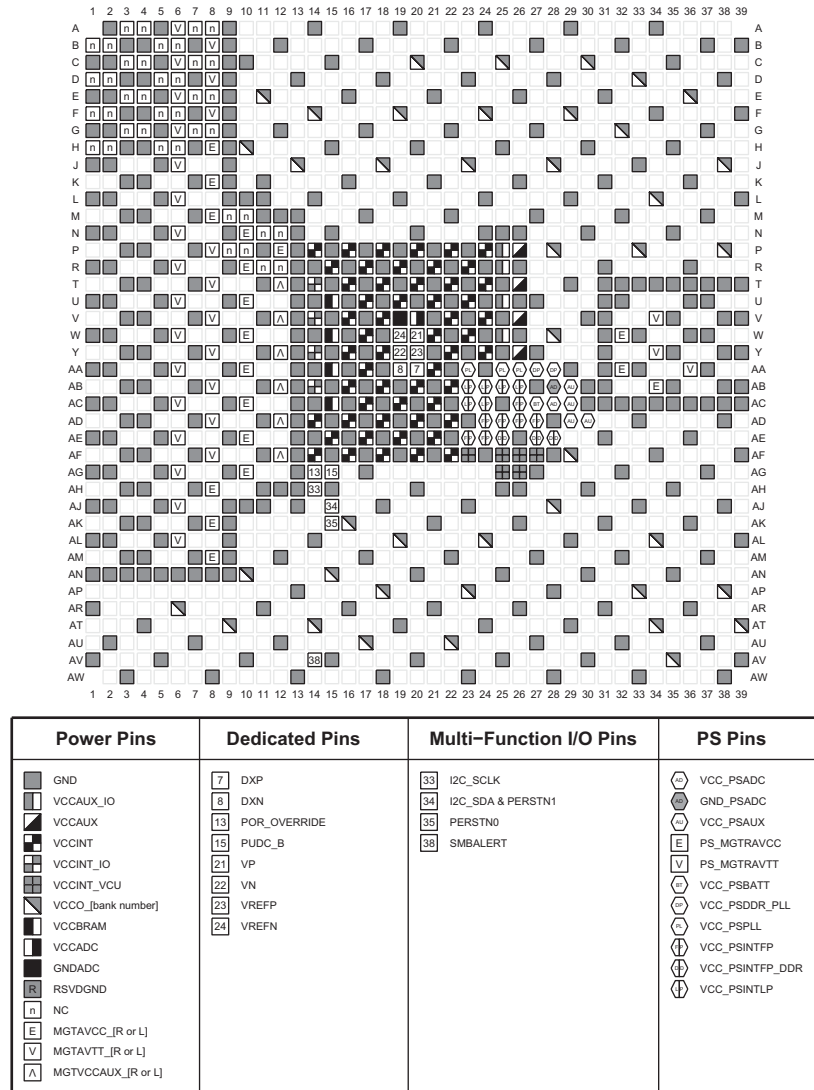

Figure 4-76: FFVF1517 Package—XCZU7EV Power, Dedicated, and Multi-function Pin Diagram

FFVF1517 Package—XCZU11EG

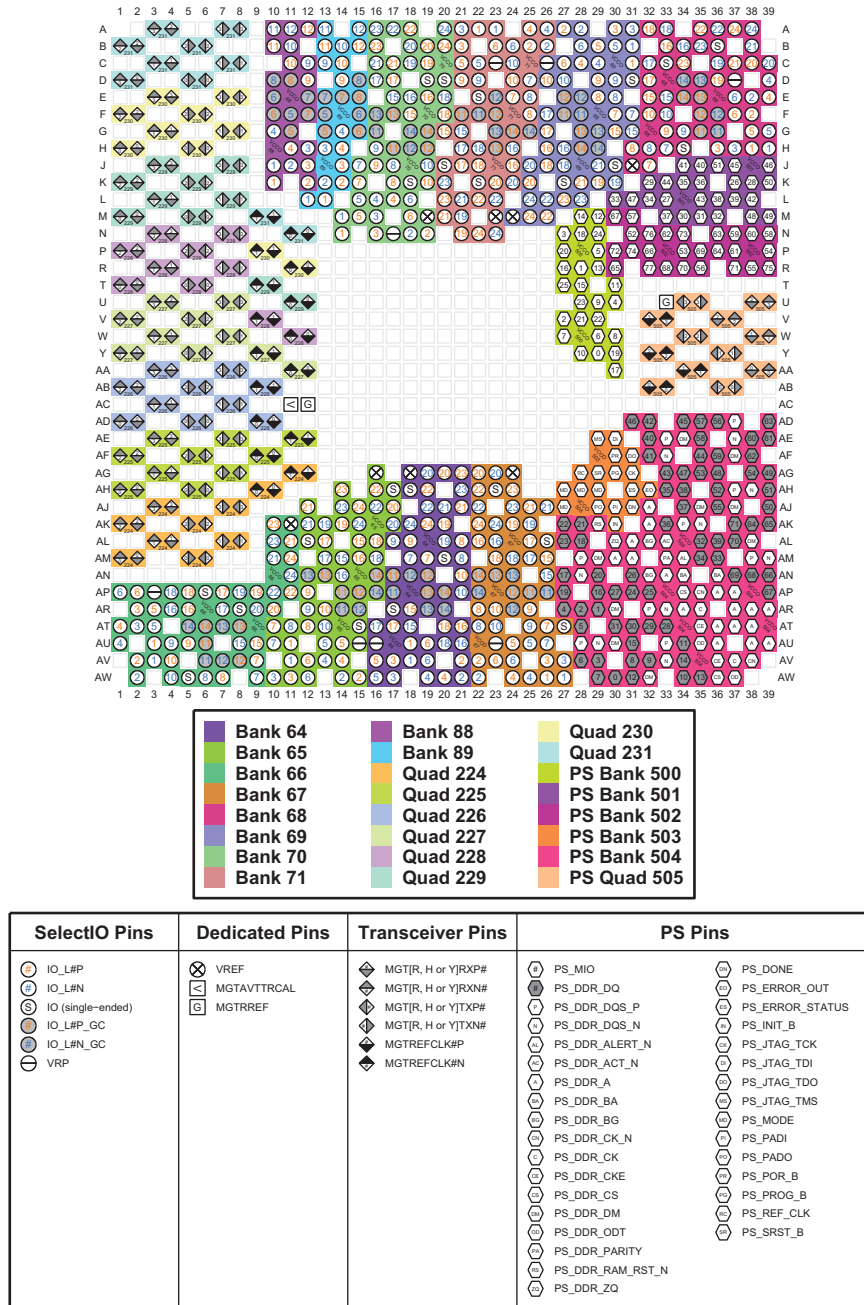

Figure 4-77: FFVF1517 Package—XCZU11EG I/O Bank Diagram

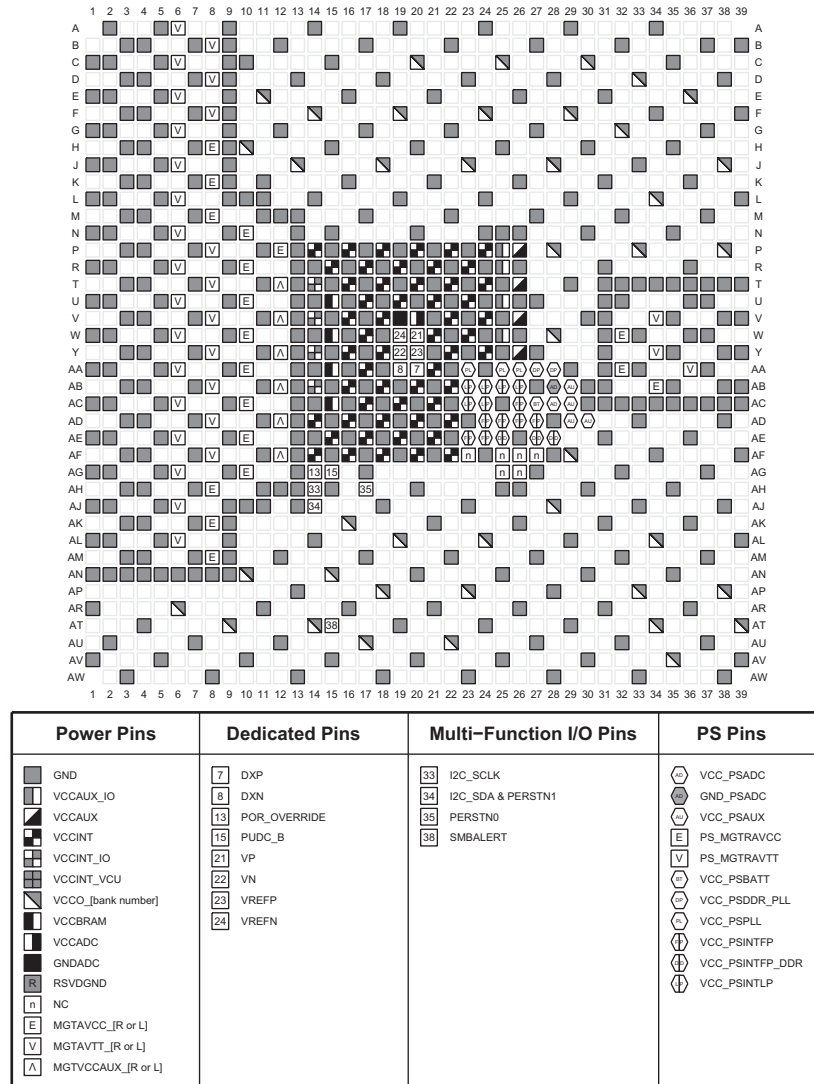

Figure 4-78: FFVF1517 Package—XCZU11EG Power, Dedicated, and Multi-function Pin Diagram

FFVG1517 and FSVG1517 Packages—XCZU25DR

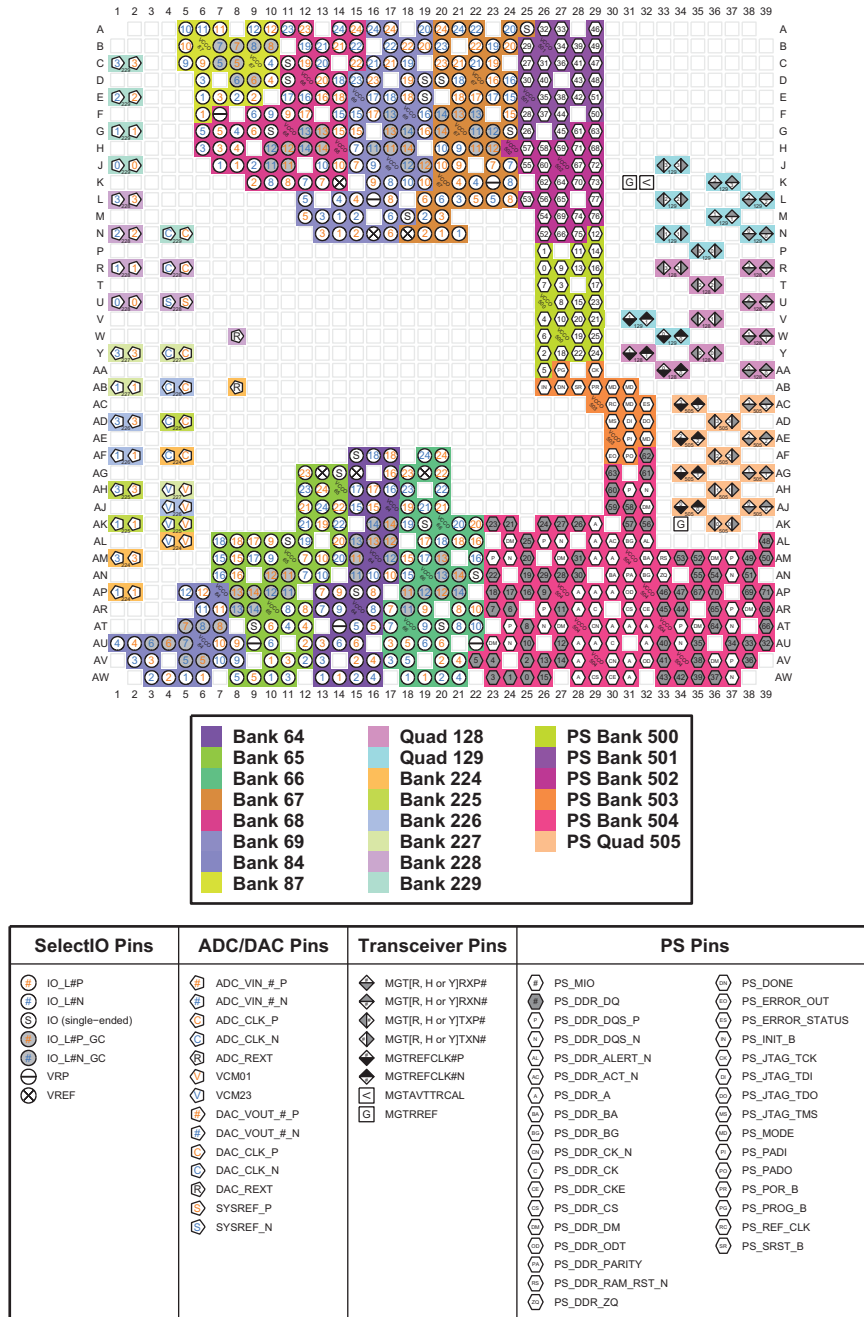
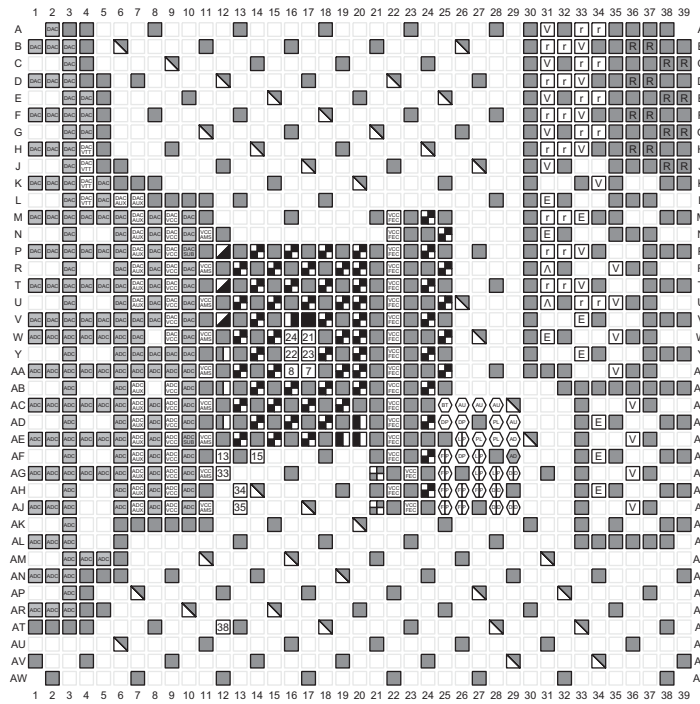

Figure 4-79: FFVG1517 and FSVG1517 Packages—XCZU25DR I/O Bank Diagram



Power Pins		Dedicated Pins	Multi-Function I/O Pins	PS Pins
GND	VCCSDFEC	DXP	I2C_SCLK	VCC_PSADC
VCCAUX_IO	VCCINT_AMS	DXN	I2C_SDA & PERSTN1	GND_PSADC
VCCAUX	ADC_AVCC	POR_OVERRIDE	PERSTN0	VCC_PSAUX
VCCINT	ADC_AVCCAUX	PUDC_B	SMBALERT	PS_MGTRAVCC
VCCINT_IO	ADC_GND	VP		VCC_PSBATT
VCCINT_VCU	ADC_SUB_GND	VN		VCC_PSDDRR_PLL
VCCO_bank number	DAC_AVCC	VREFP		VCC_PSPLL
VCCBRAM	DAC_AVCCAUX	VREFN		VCC_PSINTFP
VGCADC	DAC_AVTT			VCC_PSINTFP_DDR
GNDADC	DAC_GND			VCC_PSINTLP
RSVD	DAC_SUB_GND			
RSVDGND	NC			
MGTAVCC_IR or LJ				
MGTAVTT_IR or LJ				
MGTVCCAUX_IR or LJ				

Figure 4-80: FFG1517 and FSVG1517 Packages—XCZU25DR Power, Dedicated, and Multi-function Pin Diagram

FFVG1517 and FSVG1517 Packages—XCZU27DR and XCZU28DR

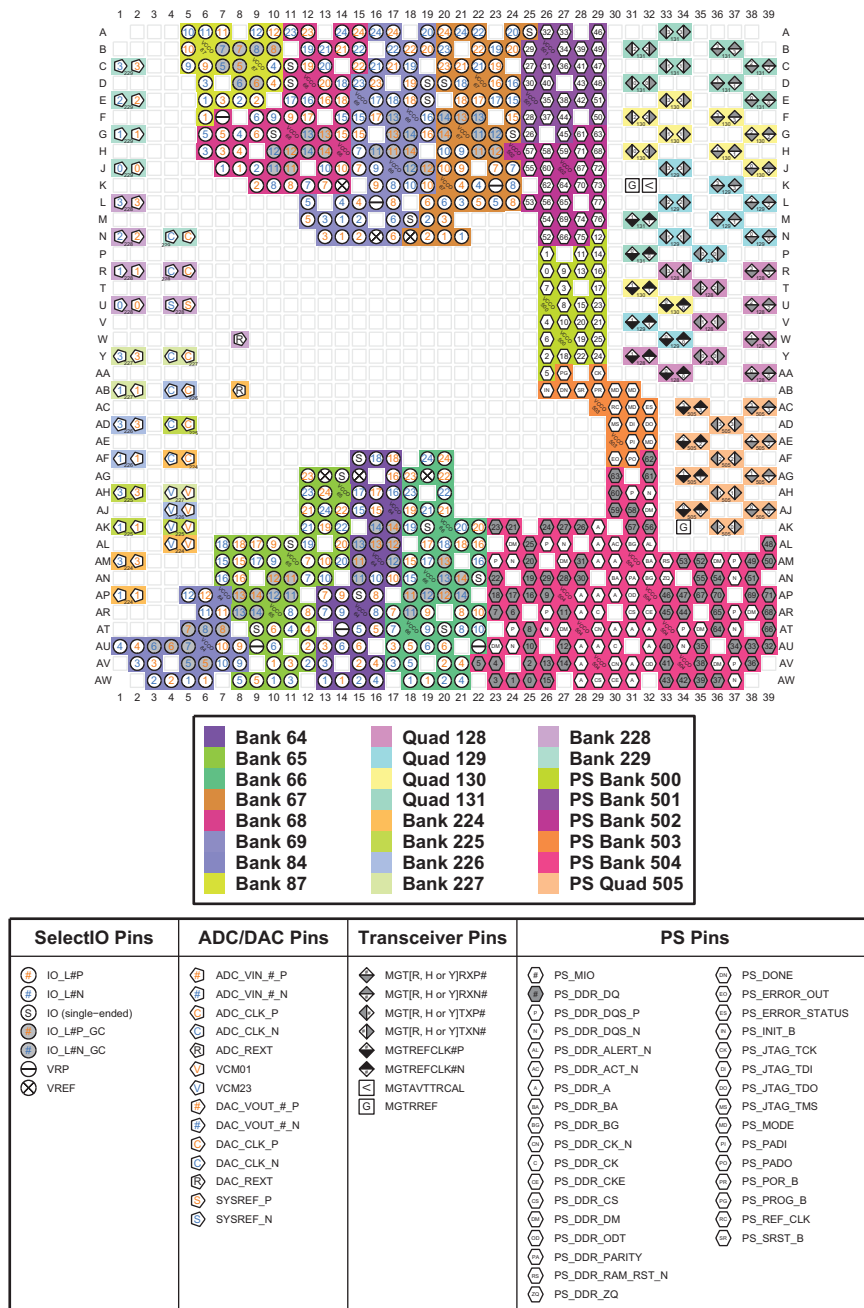

Figure 4-81: FFVG1517 and FSVG1517 Packages—XCZU27DR and XCZU28DR I/O Bank Diagram

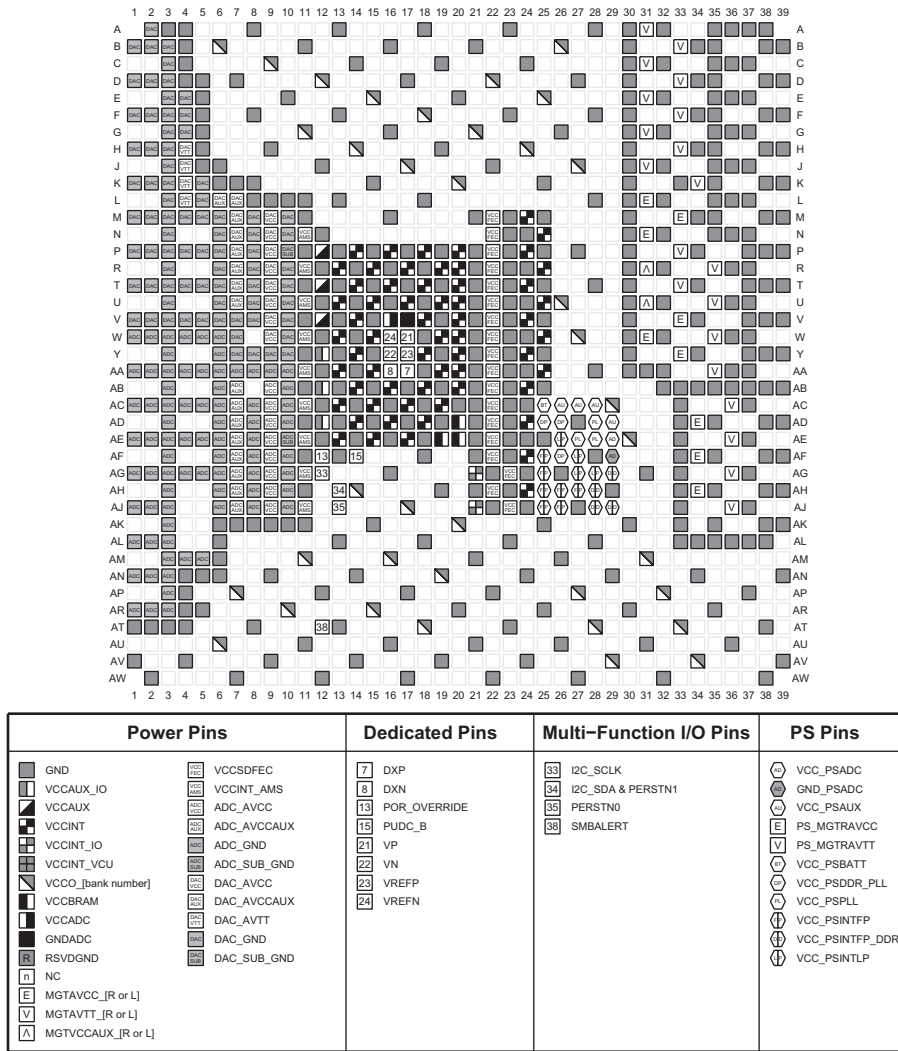

Figure 4-82: FVVG1517 and FSVG1517 Packages—XCZU27DR and XCZU28DR Power, Dedicated, and Multi-function Pin Diagram

Note: VCCAUX_IO pins for the XQ versions of these devices in these packages are split into VCCAUX_HPIO and VCCAUX_HDIO. Refer to the package files for VCCAUX_HPIO and VCCAUX_HDIO pin locations.

FFVG1517 and FSVG1517 Packages—XCZU43DR

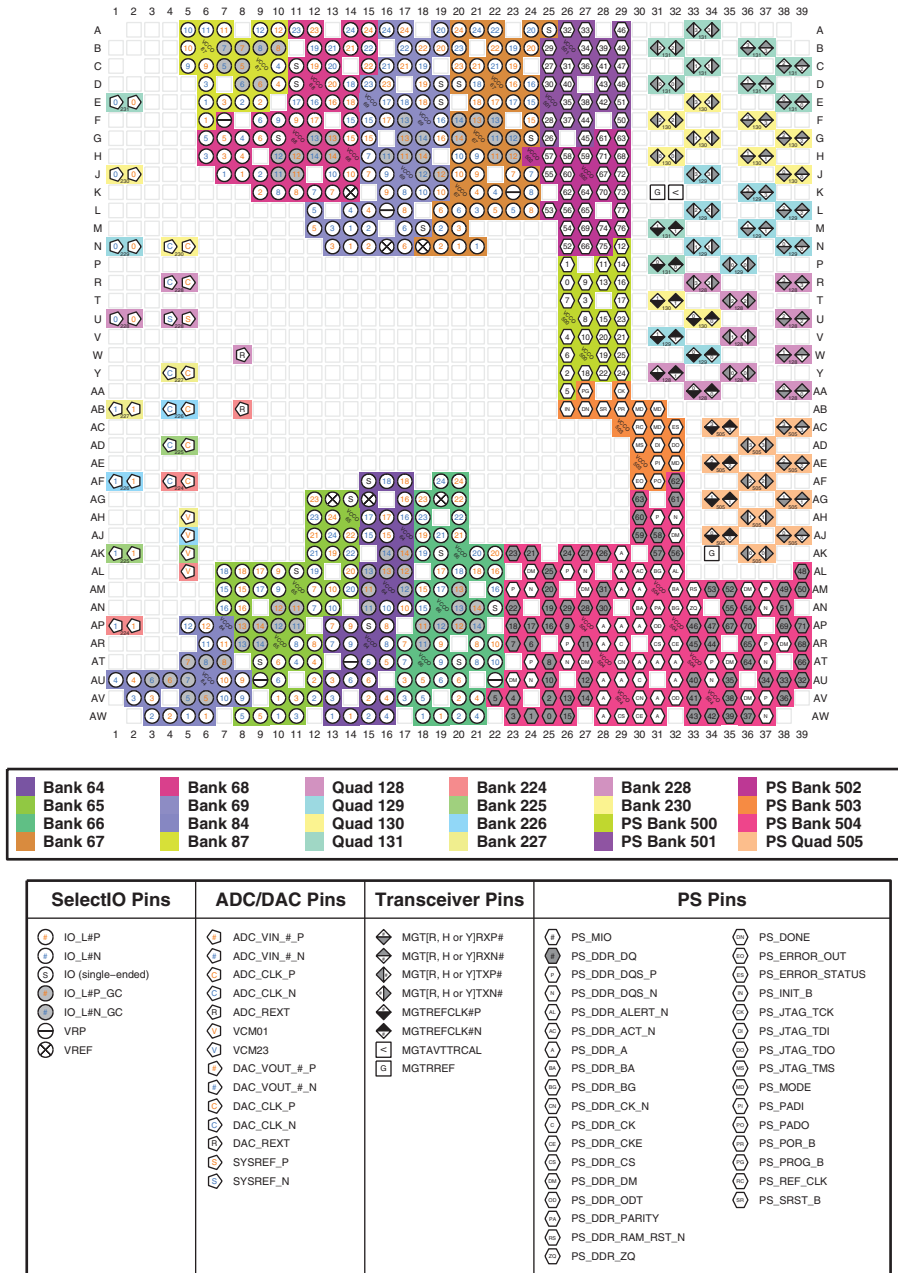

Figure 4-83: FFVG1517 and FSVG1517 Packages—XCZU43DR I/O Bank Diagram

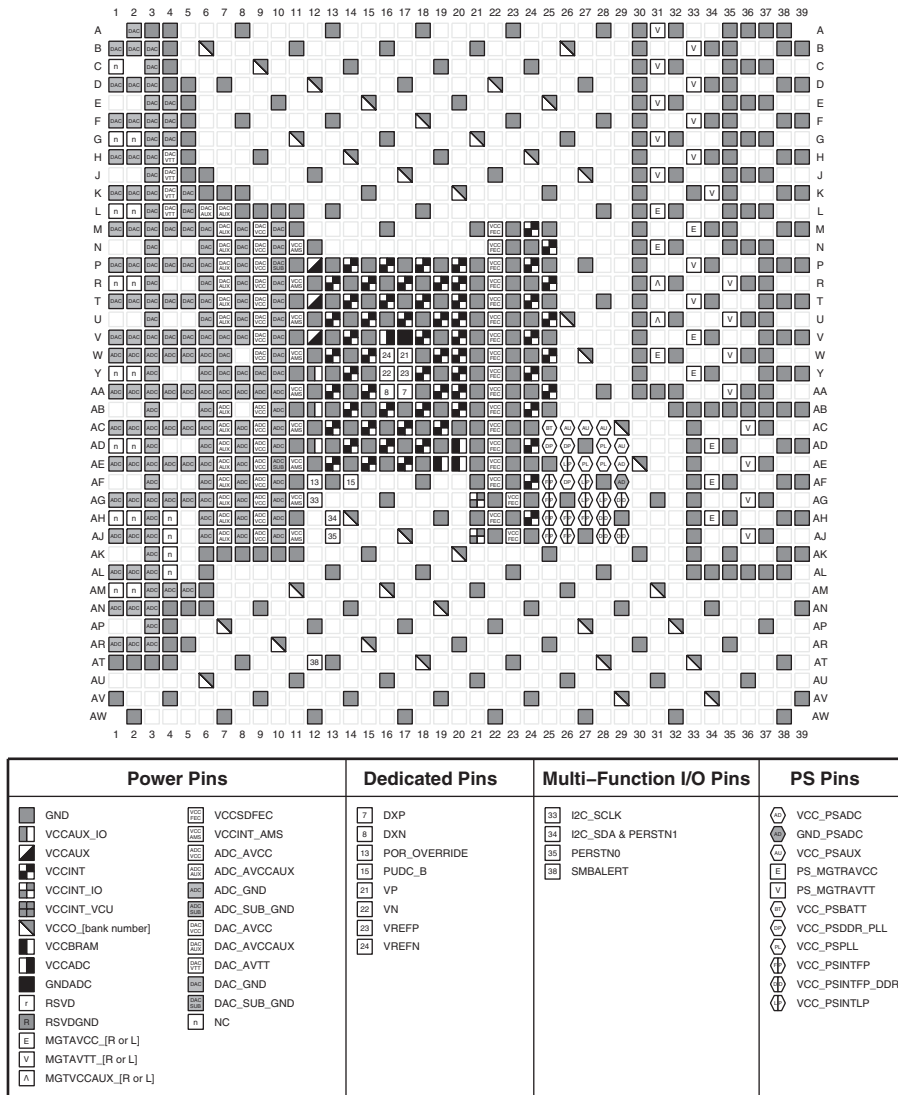

Figure 4-84: FFG1517 and FSVG1517 Packages—XCZU43DR Power, Dedicated, and Multi-function Pin Diagram

FFVG1517 and FSVG1517 Packages—XCZU47DR

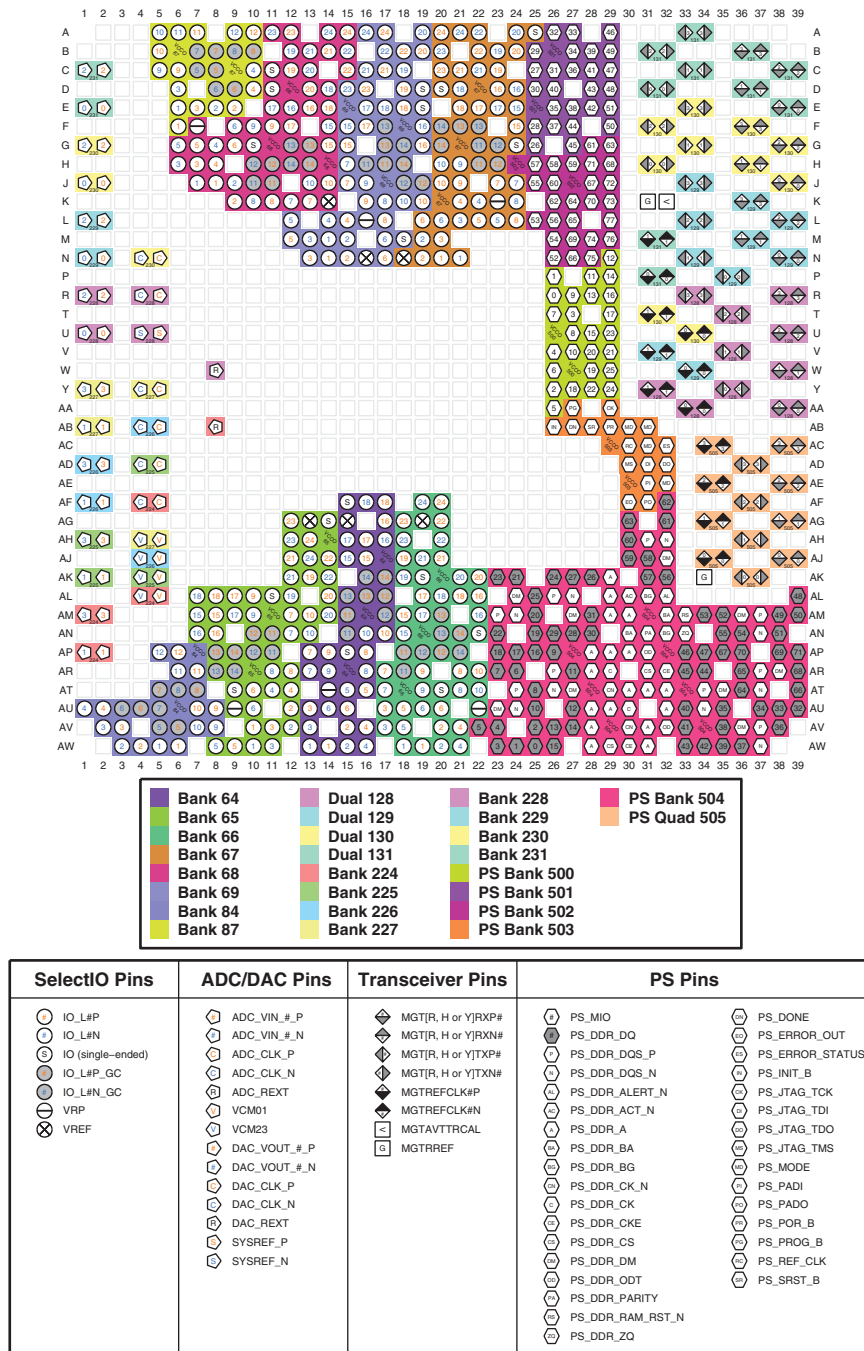
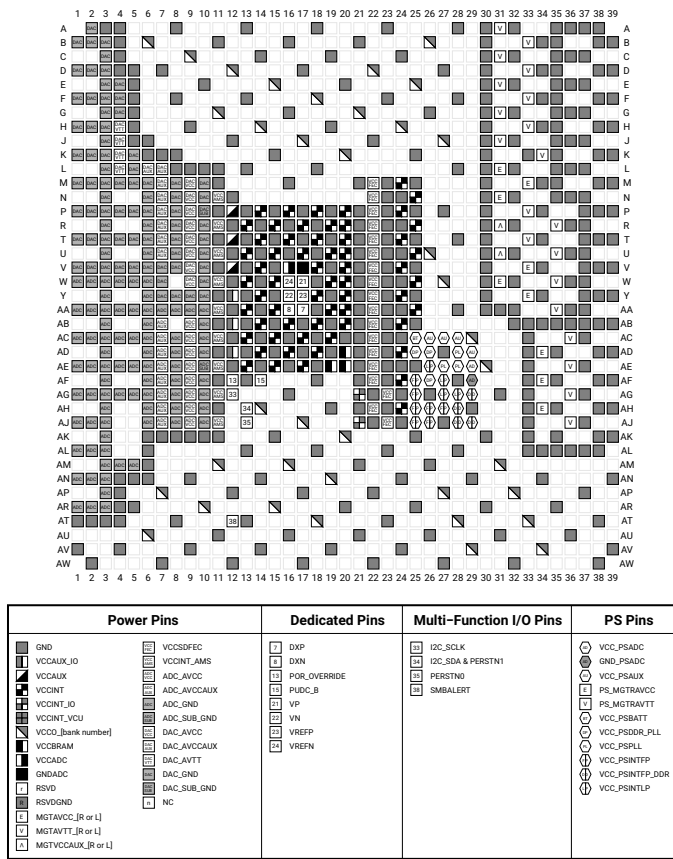

Figure 4-85: FFVG1517 and FSVG1517 Packages—XCZU47DR I/O Bank Diagram



X29469-072424

Figure 4-86: FFVG1517 and FSVG1517 Packages—XCZU47DR Power, Dedicated, and Multi-function Pin Diagram

FFVG1517, FSVG1517 Packages—XCZU48DR FSRG1517 Package—XQZU48DR

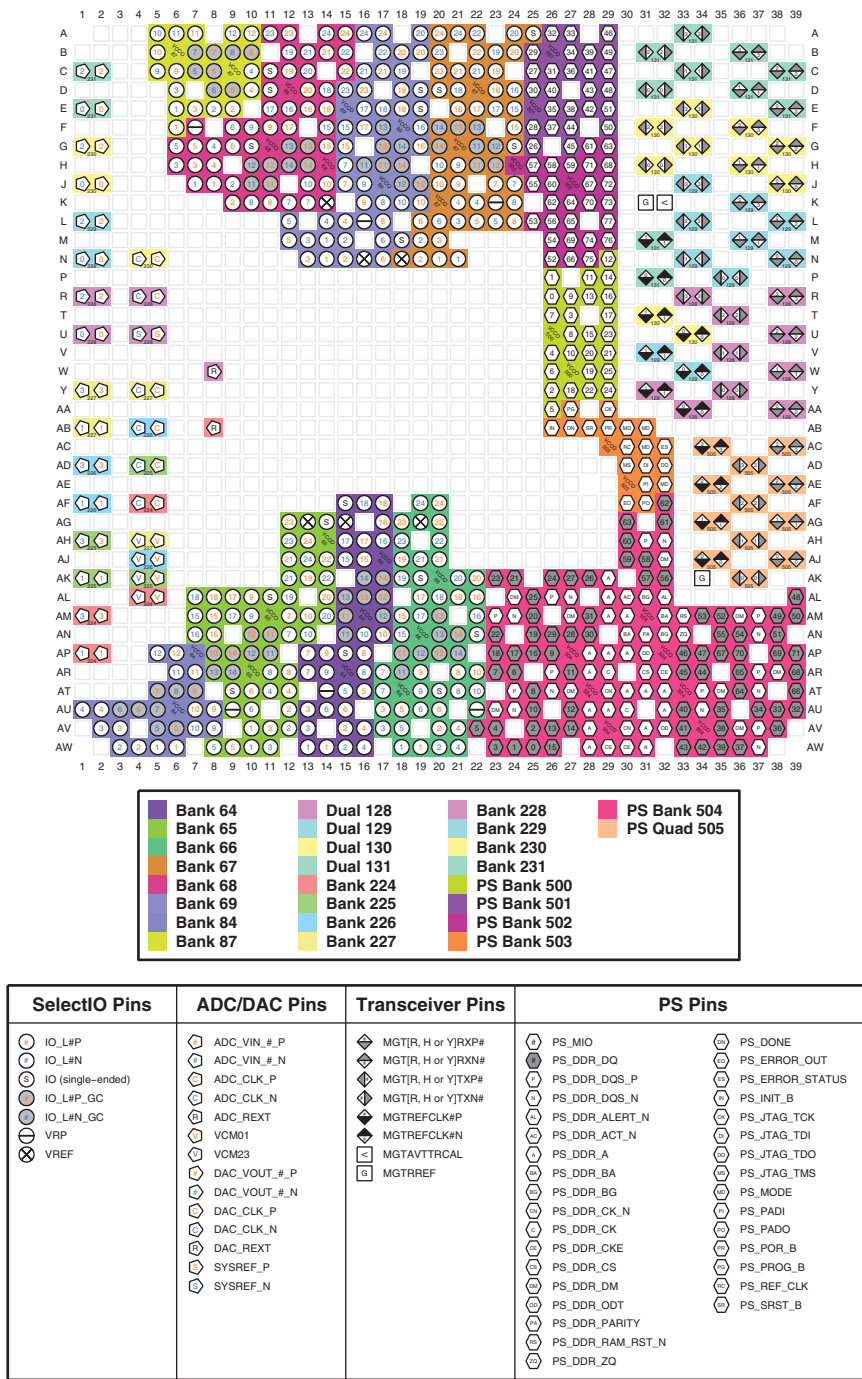
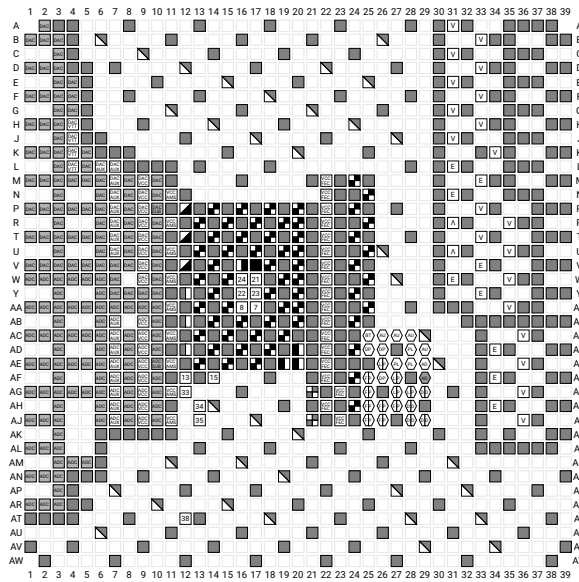

Figure 4-87: FFVG1517, FSVG1517, FSRG1517 Packages—XCZU48DR, XQZU48DR I/O Bank Diagram



Power Pins		Dedicated Pins	Multi-Function I/O Pins	PS Pins
	GND			
	VCCAUX_IO			
	VCCAUX			
	VCCINT			
	VCCINT_IO			
	VCCINT_VGU			
	VCCD0_[bank number]			
	VCCBRAM			
	VCCADC			
	GNDADC			
	RSVD			
	RSVGDND			
	MSTAVCC_[R or L]			
	MSTAVTT_[R or L]			
	MSTVCCAUX_[R or L]			
	VCCSFEEC			
	VCCINT_AMS			
	ADC_AVCC			
	ADC_AVCCAUX			
	ADC_GND			
	ADC_SUB_GND			
	DAC_AVCC			
	DAC_AVCCAUX			
	DAC_AVTT			
	DAC_GND			
	DAC_SUB_GND			
	NC			

X29467-072424

Figure 4-88: FVVG1517, FSVG1517, FSRG1517 Packages—XCZU48DR, XQZU48DR Power, Dedicated, and Multi-function Pin Diagram

Note: VCCAUX_IO pins for the XQ versions of these devices in these packages are split into VCCAUX_HPIO and VCCAUX_HDIO. Refer to the package files for VCCAUX_HPIO and VCCAUX_HDIO pin locations.

FFVC1760 Package—XCZU11EG

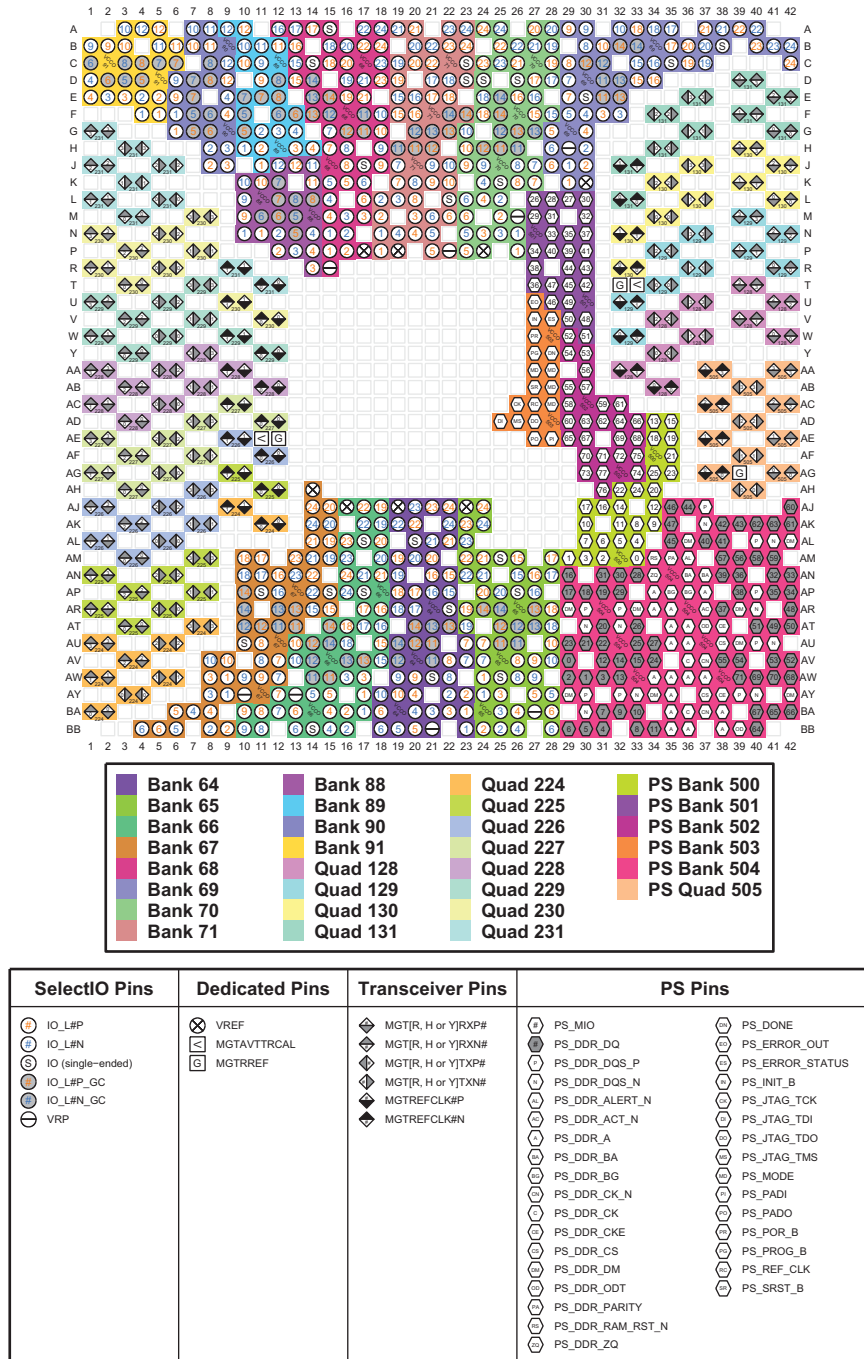

Figure 4-89: FFVC1760 Package—XCZU11EG I/O Bank Diagram

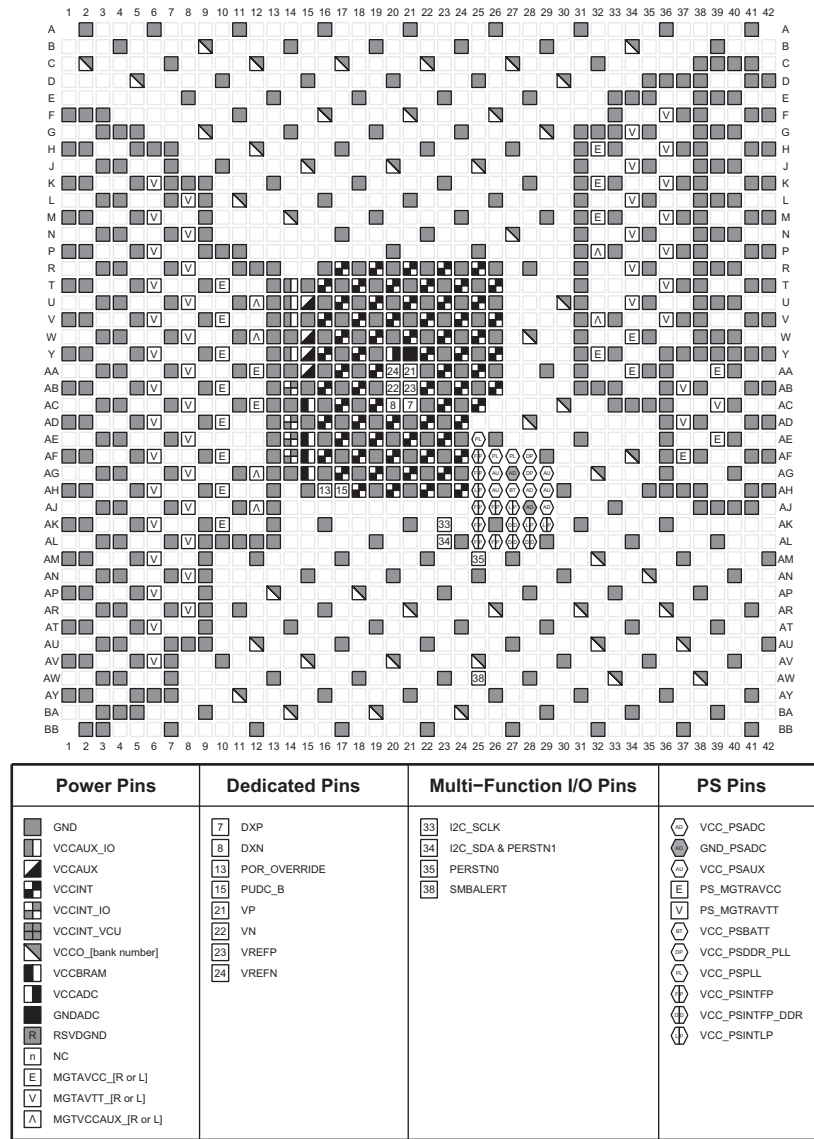

Figure 4-90: FFVC1760 Package—XCZU11EG Power, Dedicated, and Multi-function Pin Diagram

Note: VCCAUX_IO pins for the XQ versions of this device in this package are split into VCCAUX_HPIO and VCCAUX_HDIO. Refer to the package files for VCCAUX_HPIO and VCCAUX_HDIO pin locations.

FFVC1760 Package—XCZU17EG and XCZU19EG

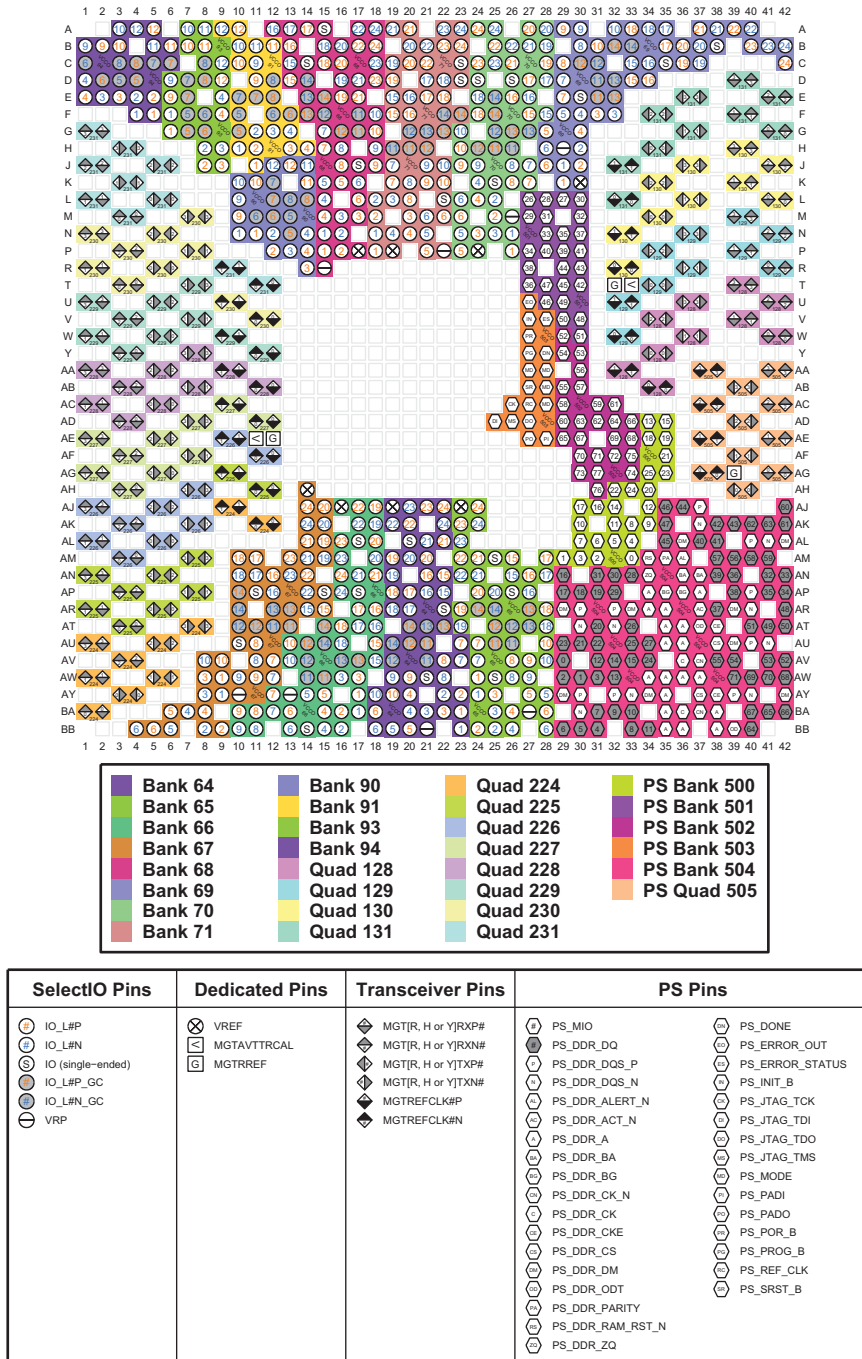

Figure 4-91: FFVC1760 Package—XCZU17EG and XCZU19EG I/O Bank Diagram

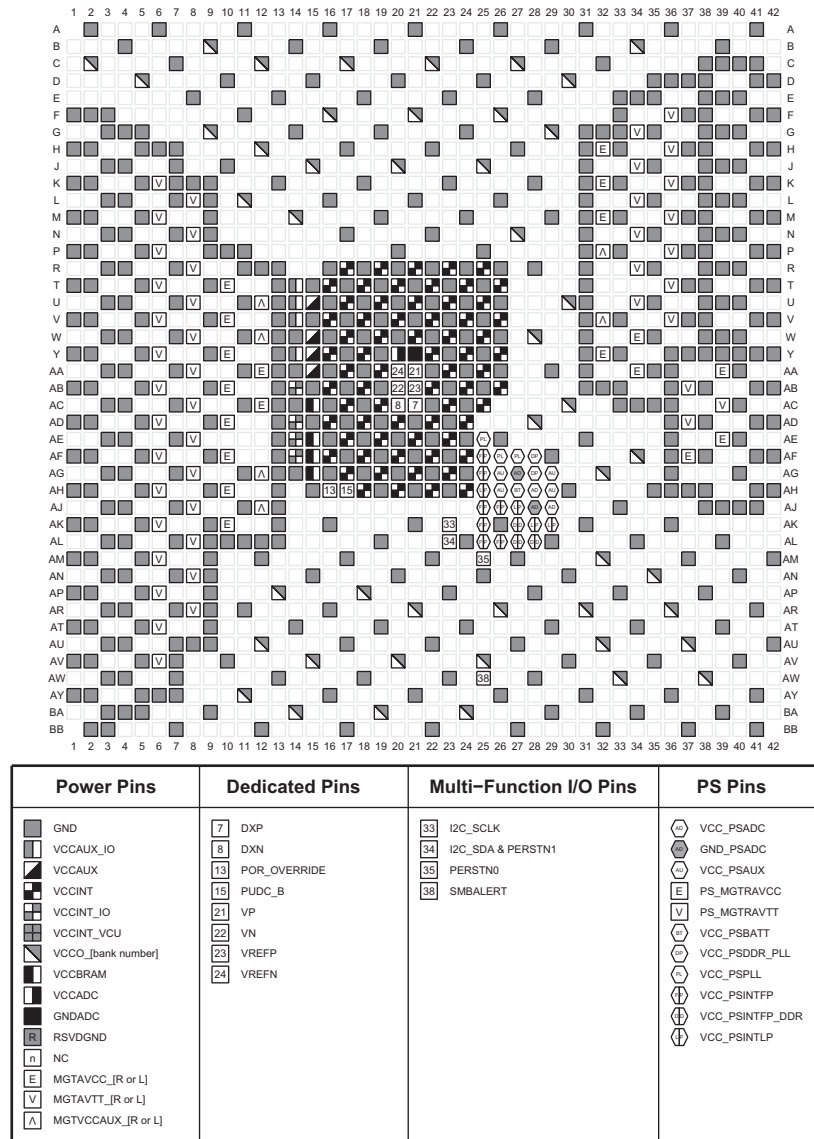

Figure 4-92: FFVC1760 Package—XCZU17EG and XCZU19EG Power, Dedicated, and Multi-function Pin Diagram

Note: VCCAUX_IO pins for the XQ versions of these devices in this package are split into VCCAUX_HPIO and VCCAUX_HDIO. Refer to the package files for VCCAUX_HPIO and VCCAUX_HDIO pin locations.

FFVD1760 Package—XCZU17EG and XCZU19EG

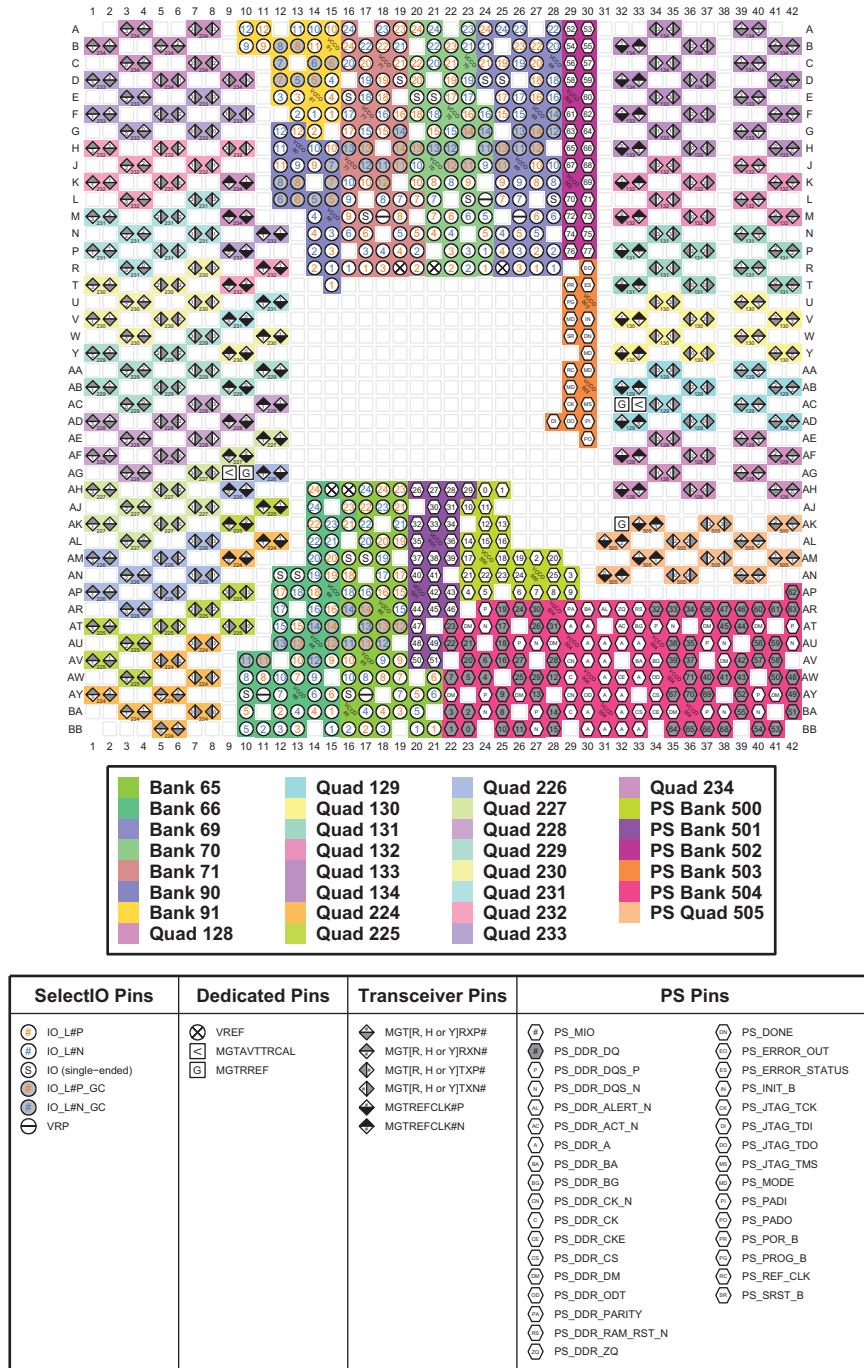

Figure 4-93: FFVD1760 Package—XCZU17EG and XCZU19EG I/O Bank Diagram

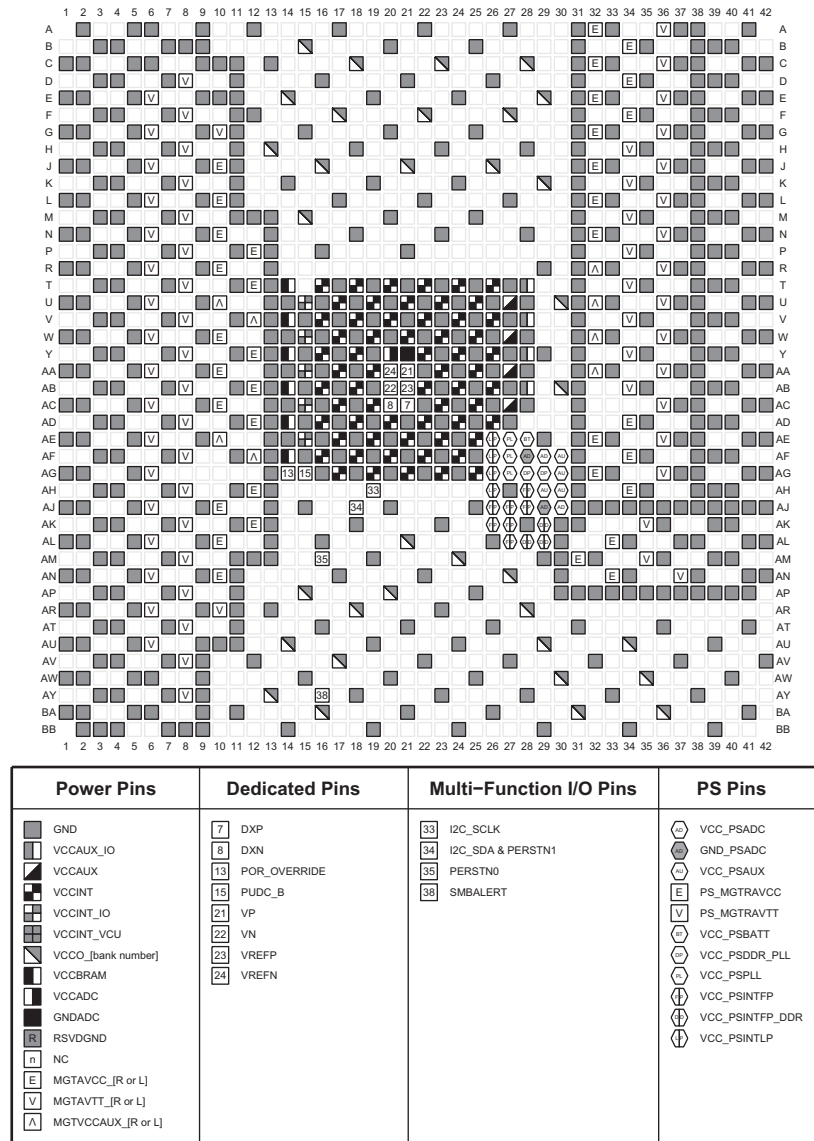

Figure 4-94: FFVD1760 Package—XCZU17EG and XCZU19EG Power, Dedicated, and Multi-function Pin Diagram

FFVF1760 and FSVF1760 Packages—XCZU29DR and XCZU39DR

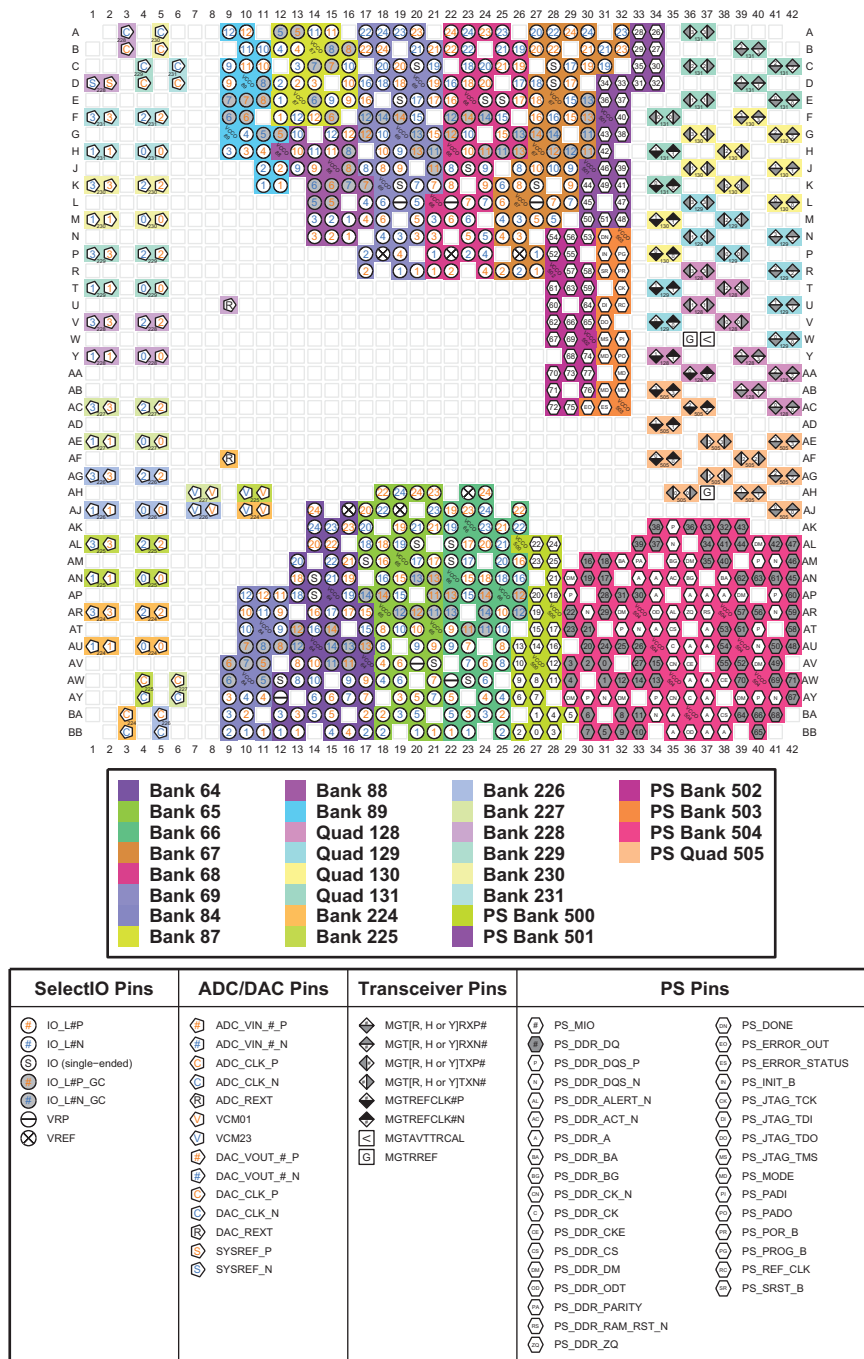

Figure 4-95: FFVF1760 and FSVF1760 Packages—XCZU29DR and XCZU39DR I/O Bank Diagram

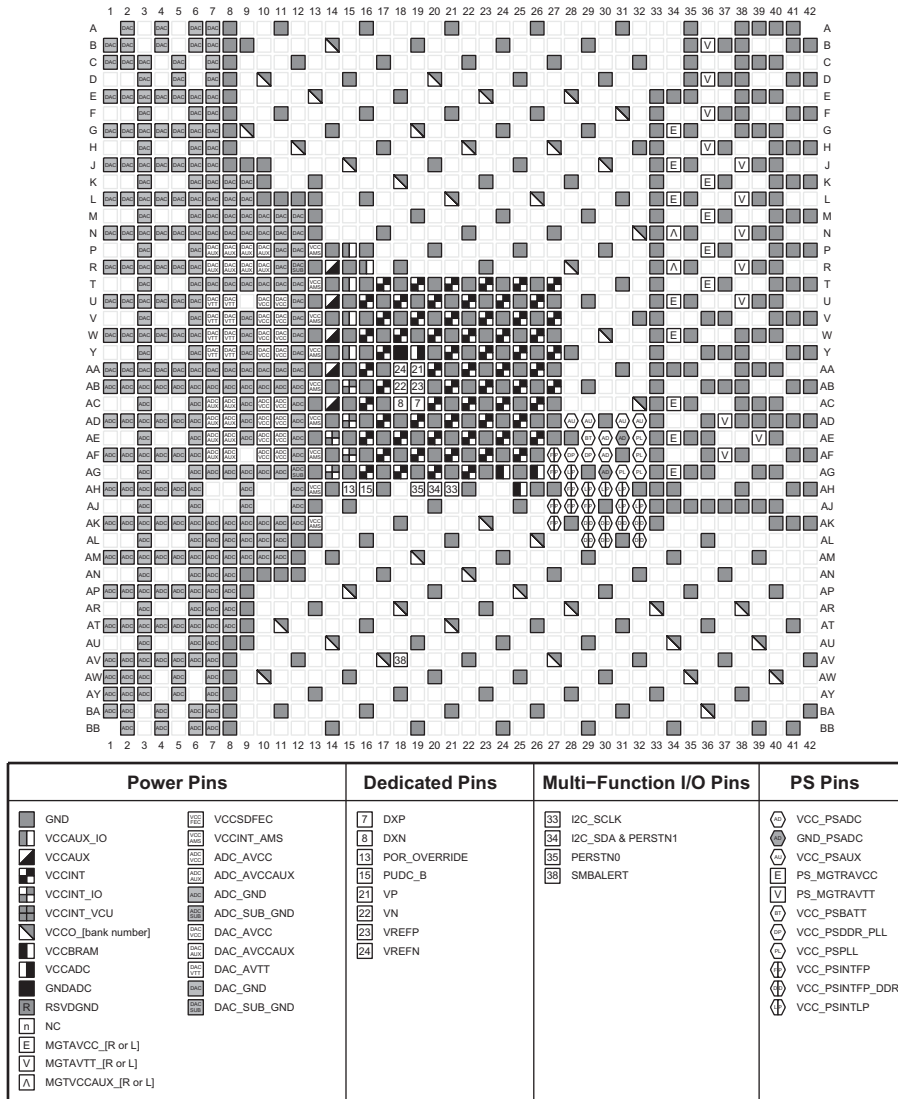

Figure 4-96: FFVF1760 and FSVF1760 Packages—XCZU29DR and XCZU39DR Power, Dedicated, and Multi-function Pin Diagram

Note: VCCAUX_IO pins for the XQ versions of these devices in these packages are split into VCCAUX_HPIO and VCCAUX_HDIO. Refer to the package files for VCCAUX_HPIO and VCCAUX_HDIO pin locations.

FFVF1760 and FSVF1760 Packages—XCZU49DR FSRF1760 Package—XQZU49DR

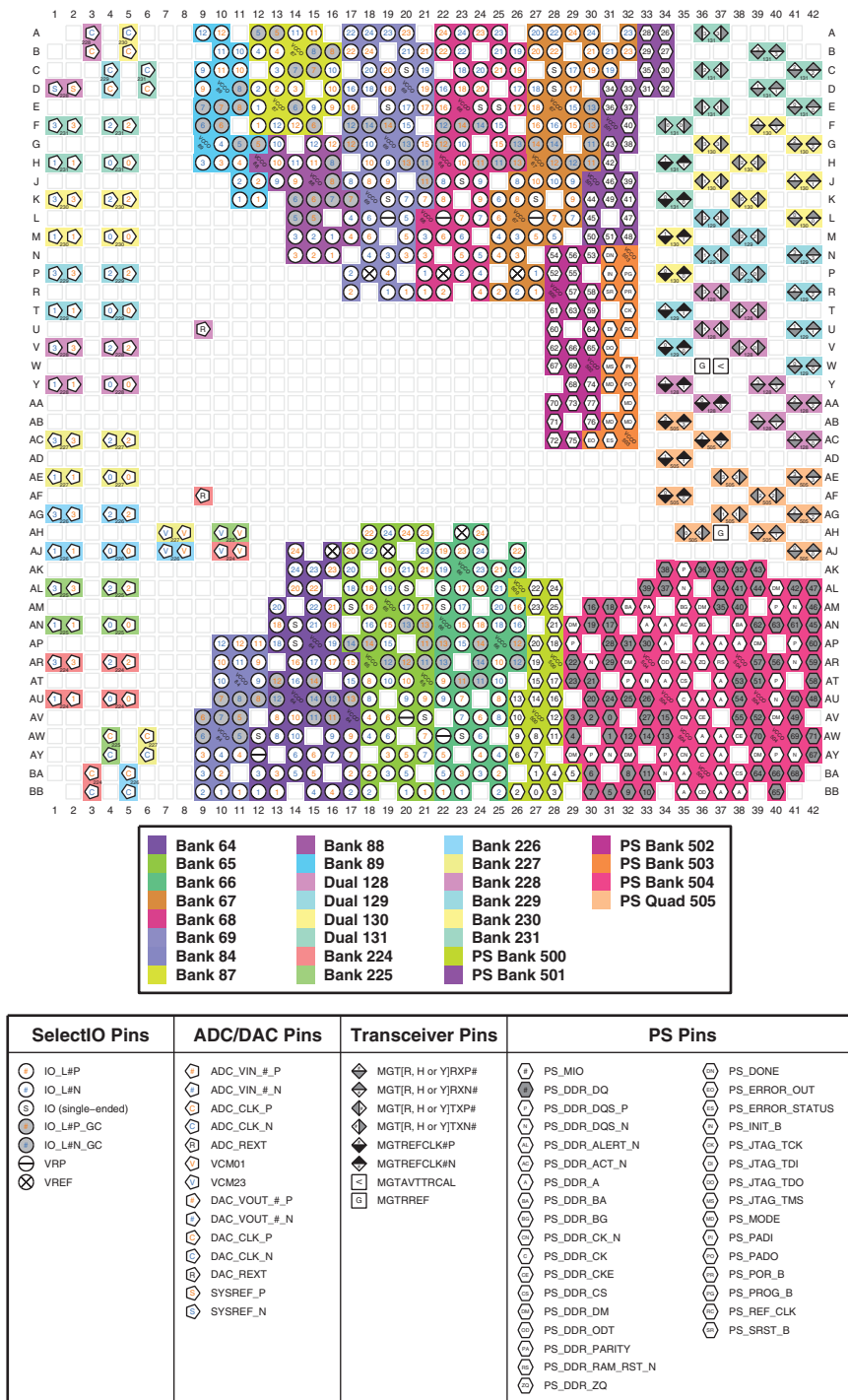
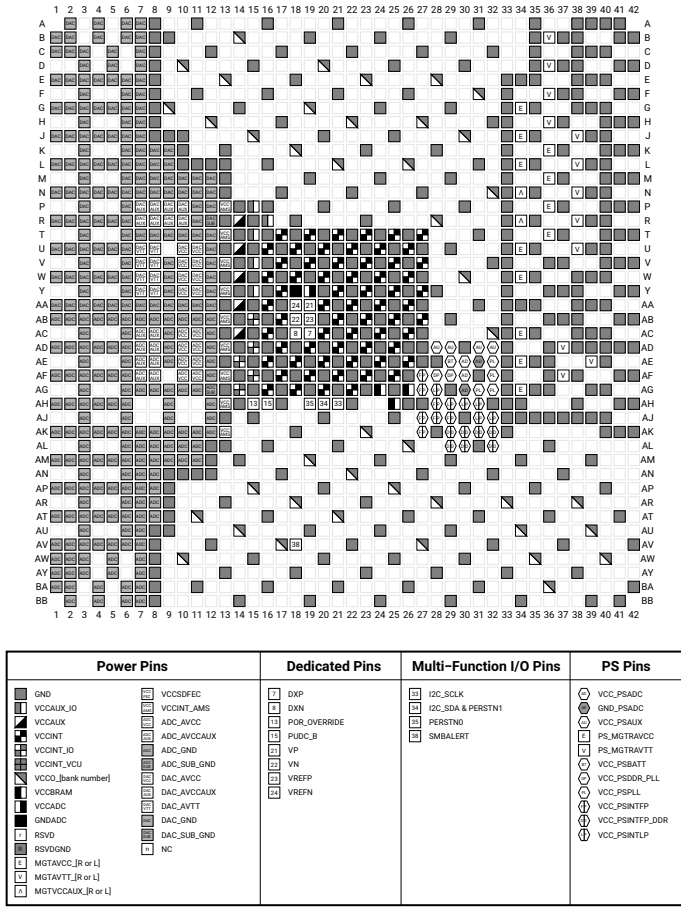

Figure 4-97: FFVF1760, FSVF1760, FSRF1760 Packages—XCZU49DR, XQZU49DR I/O Bank Diagram



X29466-072324

Figure 4-98: FFFV1760, FSVF1760, FSRF1760 Packages—XCZU49DR, XQZU49DR Power, Dedicated, and Multi-function Pin Diagram

Note: VCCAUX_IO pins for the XQ versions of these devices in these packages are split into VCCAUX_HPIO and VCCAUX_HDIO. Refer to the package files for VCCAUX_HPIO and VCCAUX_HDIO pin locations.

FFVH1760 and FSVH1760 Packages—XCZU46DR

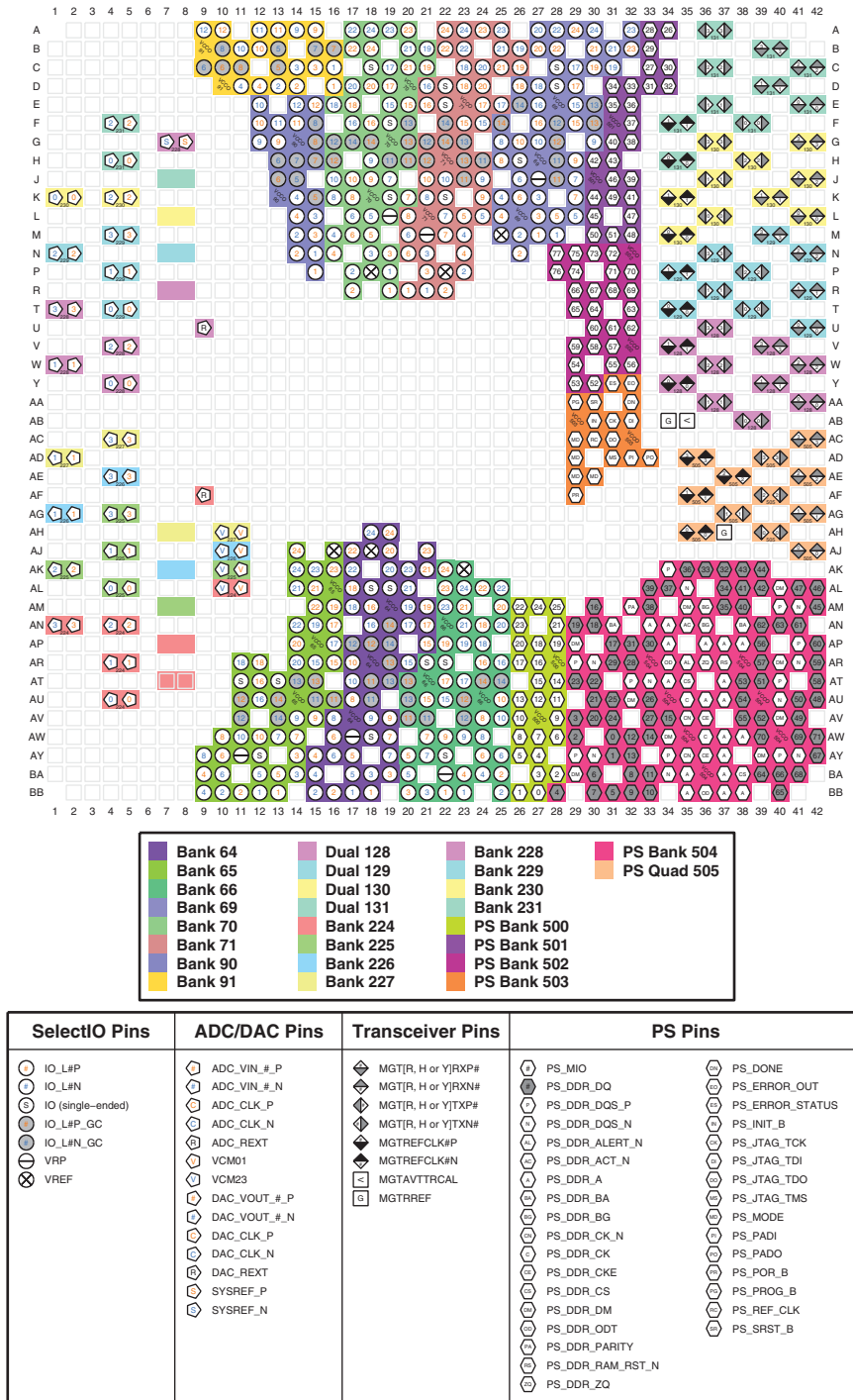
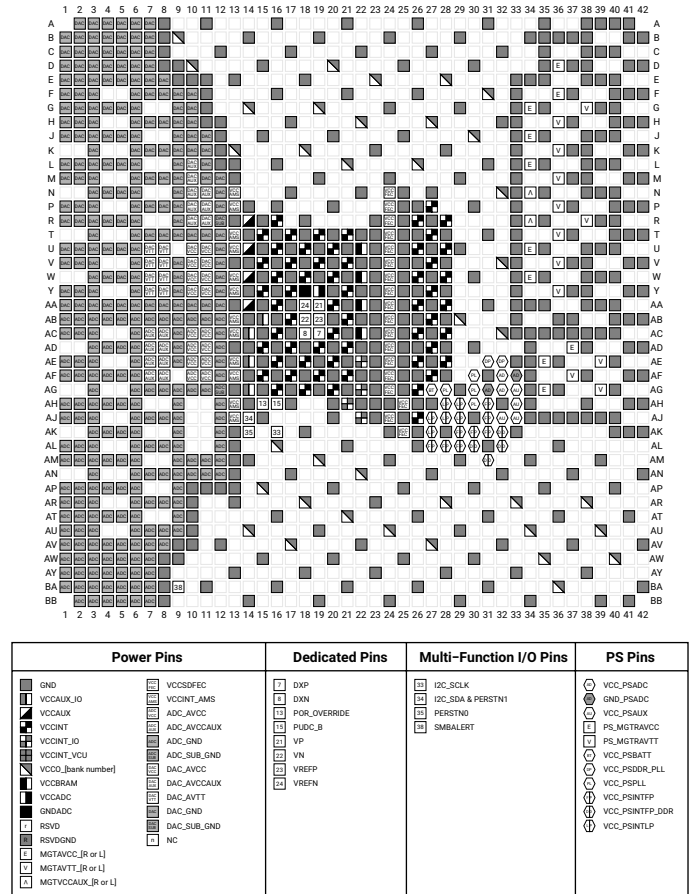

Figure 4-99: FFVH1760 and FSVH1760 Packages—XCZU46DR I/O Bank Diagram



X29463-072224

Figure 4-100: FFVH1760 and FSVH1760 Packages—XCZU46DR Power, Dedicated, and Multi-function Pin Diagram

FFVE1924 Package—XCZU17EG and XCZU19EG

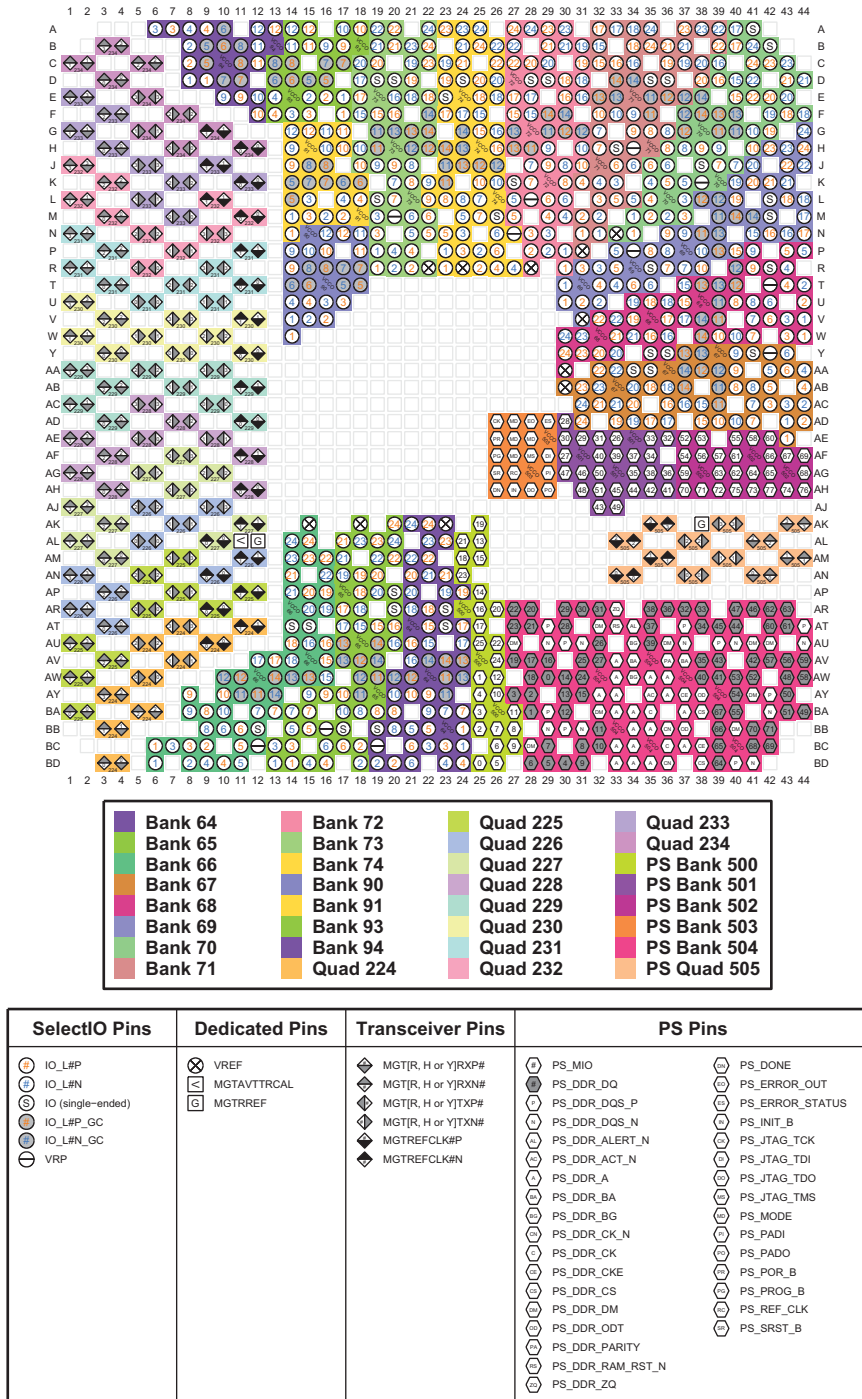

Figure 4-101: FFVE1924 Package—XCZU17EG and XCZU19EG I/O Bank Diagram

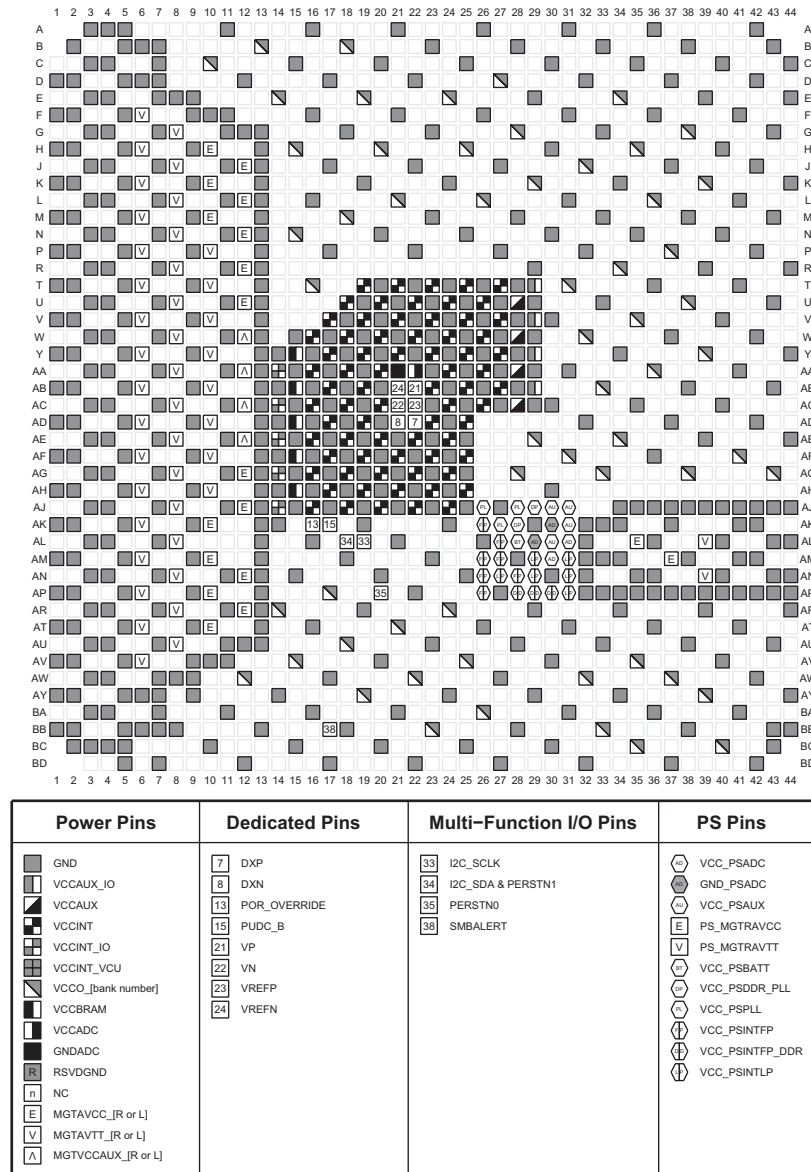

Figure 4-102: FFVE1924 Package—XCZU17EG and XCZU19EG Power, Dedicated, and Multi-function Pin Diagram

Mechanical Drawings

Summary

This chapter provides mechanical drawings (package specifications) of the Zynq™ UltraScale+™ devices. [Table 5-1](#) and [Table 5-2](#) cross-reference to the mechanical drawings by device and package combination. See [Package Specifications Designations in Chapter 3](#) for definitions of [Evaluation Only](#), [Engineering Sample](#), and [Production](#) mechanical drawings.



IMPORTANT: *All non-InFO packages are available with eutectic BGA balls. To order these packages, the device type starts with an XQ vs. XC or XA, and the Pb-free signifier in the package name is Q. For the mechanical drawings, refer to the Pb-free version of these packages.*



TIP: *For information on materials composition and weight of a device, refer to the material declaration data sheet (MDDS). MDDS files: [Click on this link](#) to find the Zynq UltraScale+ devices [Packaging Specifications](#). In step 2 select the product category: SoCs, MPSoCs & RFSOCs. In step 3, select the product type. In step 4, click on the package specifications selection to find the available MDDS files. All published MDDS files are also available on the [See All Package Specifications](#) page.*

Table 5-1: Cross-Reference to Zynq UltraScale+ MPSoC Mechanical Drawings by Package

Package	Device									
	XCZU1CG XCZU1EG XAZU1EG	XCZU2CG XCZU2EG XAZU2EG	XCZU3CG XCZU3EG XAZU3EG XQZU3EG	XCZU3TCG XCZU3TEG	XCZU4CG XCZU4EG XCZU4EV XAZU4EV	XCZU5CG XCZU5EG XCZU5EV XAZU5EV XQZU5EV	XCZU6CG XCZU6EG	XCZU7CG XCZU7EG XCZU7EV XAZU7EV XQZU7EV	XCZU9CG XCZU9EG XQZU9EG	XCZU11EG XAZU11EG XQZU11EG
SBVA484	Figure 5-1 Production	Figure 5-2 Production	Figure 5-3 Production							
SFRA484			Figure 5-3 Production							
UBVA494	Figure 5-4 Engineering Sample									
UBVA530		Figure 5-5 Production	Figure 5-5 Production							
SFVA625	Figure 5-6 Production	Figure 5-7 Production								
SFRC784			Figure 5-8 Production		Figure 5-8 Production					
SFVC784		Figure 5-9 Production		Figure 5-9 Production	Figure 5-9 Production					
SFVD784										
SFVE784					Figure 5-9 Production					
FBVB900					Figure 5-10 Production		Figure 5-11 Production			
FFRB900					Figure 5-13 Production		Figure 5-12 Production			
FFRC900								Figure 5-13 Production		Figure Prod

Table 5-1: Cross-Reference to Zynq UltraScale+ MPSoC Mechanical Drawings by Package (Cont'd)

Package	Device										Figure Prod
	XCZU1CG XCZU1EG XAZU1EG	XCZU2CG XCZU2EG XAZU2EG	XCZU3CG XCZU3EG XAZU3EG XQZU3EG	XCZU3TCG XCZU3TEG	XCZU4CG XCZU4EG XCZU4EV XAZU4EV	XCZU5CG XCZU5EG XCZU5EV XAZU5EV XQZU5EV	XCZU6CG XCZU6EG	XCZU7CG XCZU7EG XCZU7EV XAZU7EV XQZU7EV	XCZU9CG XCZU9EG XQZU9EG	XCZU11EG XAZU11EG XQZU11EG	
FFVC900	Figure 5-14 Production										Figure 5-14 Production
FFRB1156											Figure 5-15 Production
FFVB1156											Figure 5-16 Production
FFRC1156											Figure 5-17 Production
FFVC1156											Figure 5-18 Production
FFRB1517											
FFVB1517											Figure 5-25 Production
FFVF1517											Figure 5-25 Production
FFRC1760											Figure 5-31 Production
FFVC1760											Figure 5-30 Production
FFVD1760											
FFVE1924											

Table 5-2: Cross-Reference to Zynq UltraScale+ RFSoc Mechanical Drawings by Package

Package	Device									
	XCZU21DR XQZU21DR	XCZU25DR XCZU27DR	XCZU28DR XQZU28DR	XCZU29DR XQZU29DR	XCZU39DR	XCZU42DR	XCZU43DR	XCZU46DR	XCZU47DR XCZU48DR XQZU48DR	XCZU47DR XCZU48DR XQZU48DR
FFRD1156	Figure 5-19 Production									
FFVD1156	Figure 5-21 Production									
FFRE1156			Figure 5-20 Production							Figure Produ
FFVE1156		Figure 5-21 Production	Figure 5-21 Production		Figure 5-21 Production	Figure 5-21 Production			Figure 5-21 Production	
FSVE1156		Figure 5-22 Production	Figure 5-22 Production		Figure 5-22 Production	Figure 5-22 Production			Figure 5-22 Production	
FFRG1517			Figure 5-26 Production							
FFVG1517		Figure 5-27 Production	Figure 5-27 Production			Figure 5-27 Production			Figure 5-27 Production	
FSRG1517									Figure 5-28 Production	
FSVG1517		Figure 5-29 Production	Figure 5-29 Production			Figure 5-29 Production			Figure 5-29 Production	
FFRF1760				Figure 5-33 Production						
FFVF1760				Figure 5-32 Production	Figure 5-32 Production					Figure Produ
FSRF1760										Figure Produ

Table 5-2: Cross-Reference to Zynq UltraScale+ RFSoc Mechanical Drawings by Package (Cont'd)

Package	Device									
	XCZU21DR XQZU21DR	XCZU25DR XCZU27DR	XCZU28DR XQZU28DR	XCZU29DR XQZU29DR	XCZU39DR	XCZU42DR	XCZU43DR	XCZU46DR	XCZU47DR XCZU48DR XQZU48DR	XCZU47DR XCZU48DR XQZU48DR
FSVF1760				Figure 5-34 Production	Figure 5-34 Production					Figure Produ
FFVH1760								Figure 5-32 Production		
FSVH1760								Figure 5-34 Production		

Table 5-3: Mechanical Drawing Dimension Definitions

Dimension	Definition
\ominus	Bilateral tolerance of package sides with respect to datums A and B
\square	Flatness tolerance of silicon die or package lid top surface
//	Bilateral tolerance for parallelism of silicon die or package lid top surface with respect to the seating plane datum C
A	Thickness of package with respect to the seating plane datum C
A ₁	Thickness of BGA balls with respect to the seating plane datum C
A ₂	Thickness of package body, including stiffener ring or lid and excluding BGA balls, with respect to the seating plane datum C
A ₃	Distance from top of silicon die to top of stiffener ring or lid with respect to the seating plane datum C
D/E	Length/width of package with respect to datums A and B
D ₁ /E ₁	Length/width of BGA matrix with respect to datums A and B
e	BGA ball pitch measured at the center of each ball
∅b	BGA ball diameter
\ominus aaa	Unidirectional upward tolerance with respect to the seating plane datum C
// bbb	Bilateral tolerance for parallelism of package surface with respect to the seating plane datum C
∅ddd	BGA ball position tolerance of diameter ddd with respect to datums A and B perpendicular to the seating plane datum C in which the center of each ball must lie
∅eee	BGA ball position tolerance of diameter eee measured with respect to other balls within the BGA matrix in which the center of each ball must lie
M	BGA ball matrix size

SBVA484 Flip-Chip, Super-Fine-Pitch BGA (XCZU1CG, XCZU1EG, and XAZU1EG)

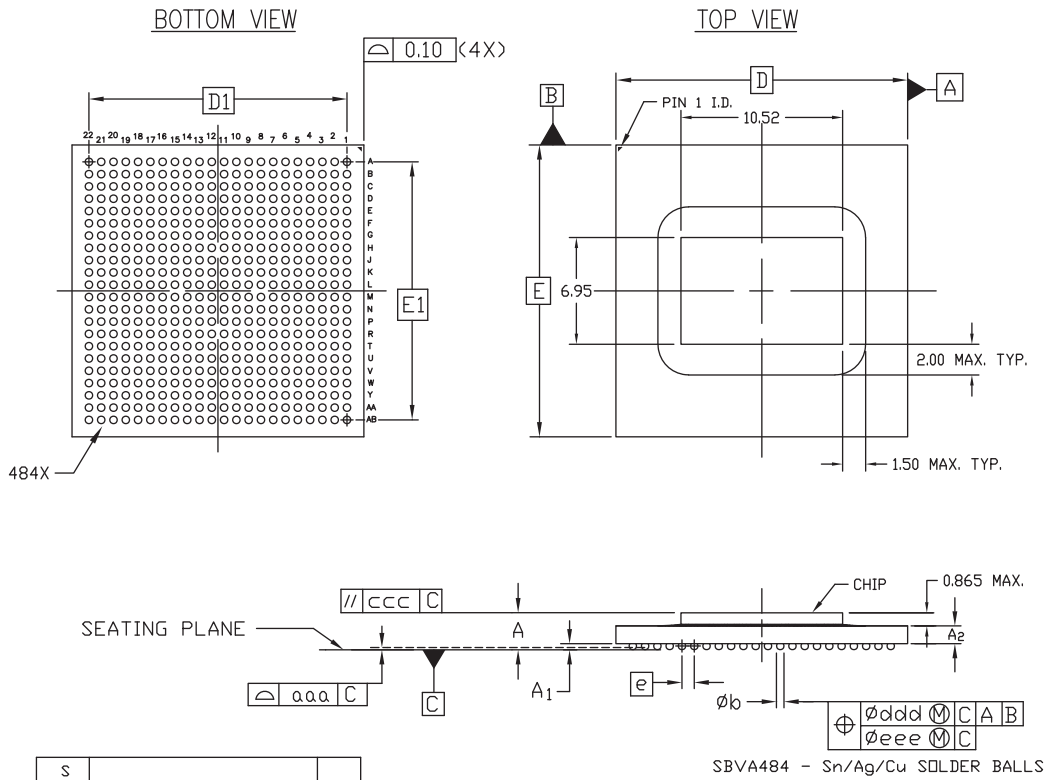

NOTES:

1. ALL DIMENSIONS AND TOLERANCES CONFORM TO ANSI Y14.5M-1994
2. SYMBOL 'M' IS THE BALL MATRIX SIZE
3. CONFORMS TO JEDEC MO-216 BAP-2

Figure 5-1: Package Dimensions for SBVA484 (XCZU1CG, XCZU1EG, and XAZU1EG)

SBVA484 Flip-Chip, Super-Fine-Pitch BGA (XCZU2, XCZU3, XAZU2EG, and XAZU3EG)

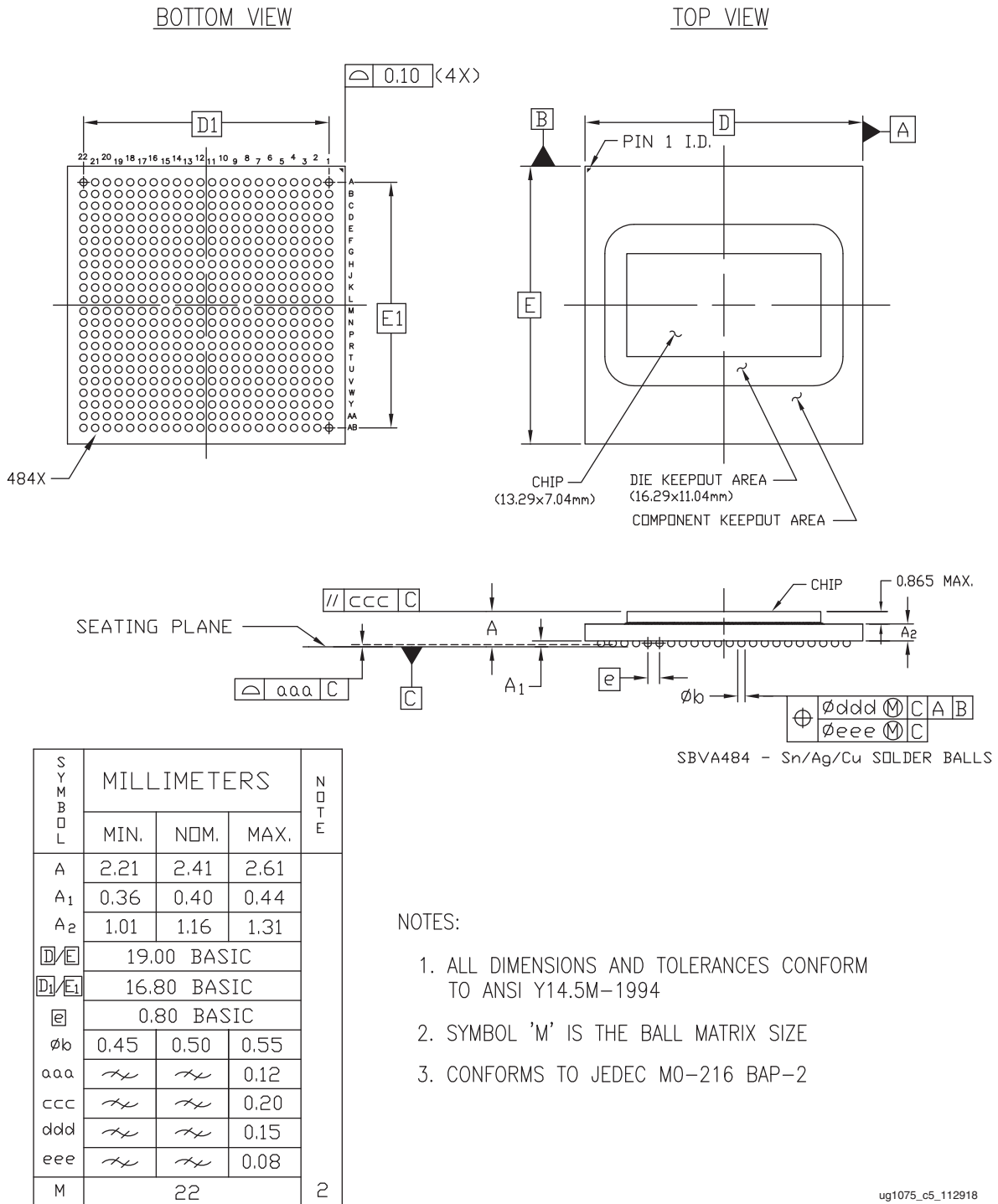
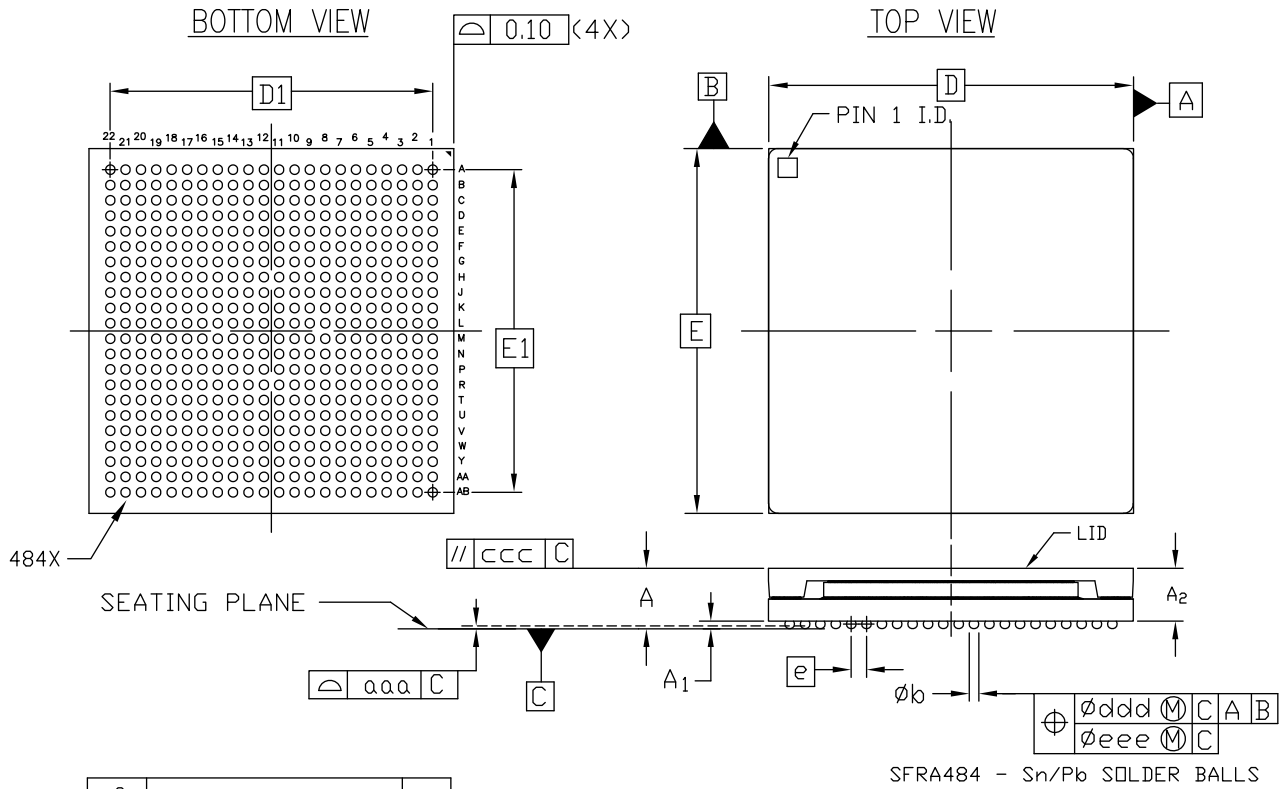

Figure 5-2: Package Dimensions for SBVA484 (XCZU2, XCZU3, XAZU2EG, and XAZU3EG)

SFRA484 Flip-Chip, Super-Fine-Pitch BGA (XQZU3EG)



SYMBOL	MILLIMETERS			NOTE
	MIN.	NOM.	MAX.	
A	2.95	3.15	3.35	2
A ₁	0.36	0.40	0.44	
A ₂	2.55	2.75	2.95	
$\frac{D}{E}$	19.00 BASIC			
$\frac{D_1}{E_1}$	16.80 BASIC			
ⓐ	0.80 BASIC			
øb	0.45	0.50	0.55	
aaa	\neq	\neq	0.12	
ccc	\neq	\neq	0.20	
ddd	\neq	\neq	0.15	
eee	\neq	\neq	0.08	
M	22			

NOTES:

1. ALL DIMENSIONS AND TOLERANCES CONFORM TO ANSI Y14.5M-1994
2. SYMBOL 'M' IS THE BALL MATRIX SIZE
3. CONFORMS TO JEDEC MO-216 BAP-2

X29043-020224

Figure 5-3: Package Dimensions for SFRA484 (XQZU3EG)

UBVA494 Flip-Chip, InFO BGA (XCZU1)

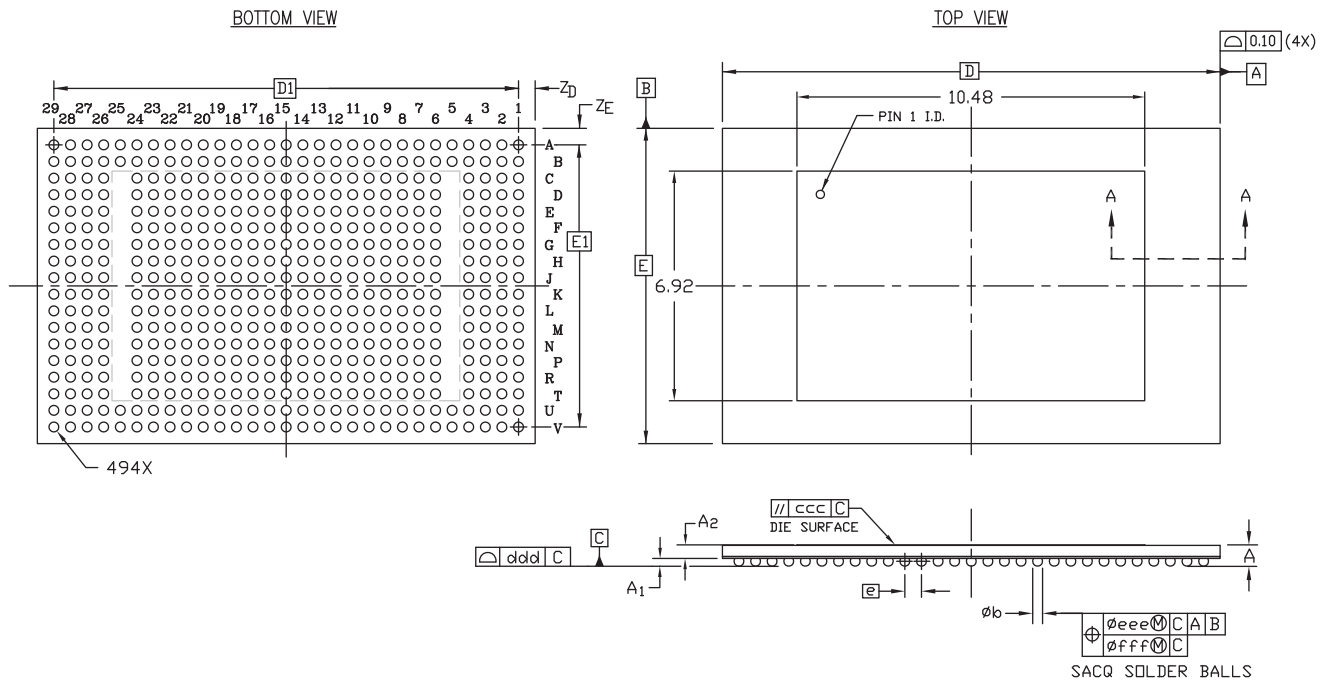

SYMBOL	MILLIMETERS			NOTE
	MIN.	NOM.	MAX.	
A	0.596	0.644	0.692	
A ₁	0.190	0.235	0.280	
A ₂	0.392	0.409	0.426	
D	14.90	15.00	15.10	
E	9.40	9.50	9.60	
D ₁	14.00 BSC			
E ₁	8.50 BSC			
e	0.50 BSC			
øb	0.25	0.30	0.35	
ccc	$\sqrt{\text{H}}$	$\sqrt{\text{H}}$	0.10	
ddd	$\sqrt{\text{H}}$	$\sqrt{\text{H}}$	0.08	
eee	$\sqrt{\text{H}}$	$\sqrt{\text{H}}$	0.15	
fff	$\sqrt{\text{H}}$	$\sqrt{\text{H}}$	0.05	
Z _D /Z _E	0.35	0.50	0.65	
M	29X18			2

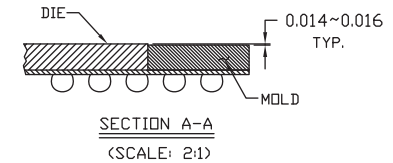

NOTES:

1. ALL DIMENSIONS AND TOLERANCES CONFORM TO ASME Y14.5M-1994
2. SYMBOL "M" IS THE PIN MATRIX SIZE

Figure 5-4: Package Dimensions for UBVA494 (XCZU1)

UBVA530 Flip-Chip, InFO BGA (XCZU2, XCZU3)

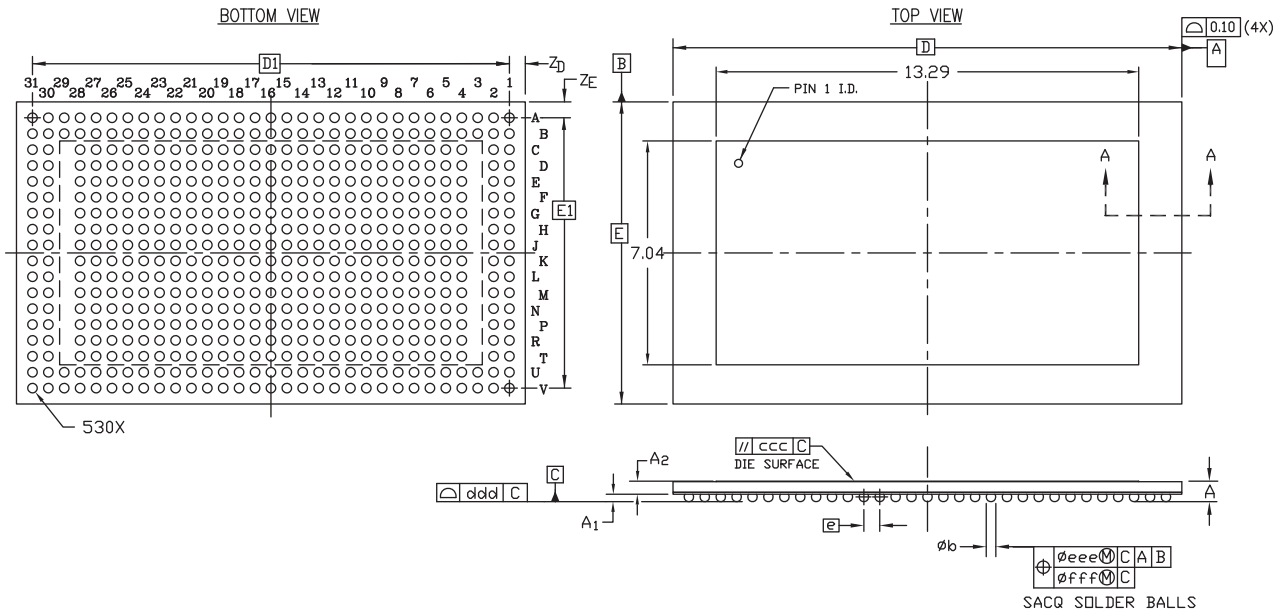

SYMBOL	MILLIMETERS			NOTE
	MIN.	NOM.	MAX.	
A	0.596	0.644	0.692	2
A ₁	0.190	0.235	0.280	
A ₂	0.392	0.409	0.426	
D	15.90	16.00	16.10	
E	9.40	9.50	9.60	
D ₁	15.00 BSC			
E ₁	8.50 BSC			
e	0.50 BSC			
øb	0.25	0.30	0.35	
ccc	\cancel{H}	\cancel{H}	0.10	
ddd	\cancel{H}	\cancel{H}	0.08	
eee	\cancel{H}	\cancel{H}	0.15	
fff	\cancel{H}	\cancel{H}	0.05	
Z _D /Z _E	0.35	0.50	0.65	
M	31X18			

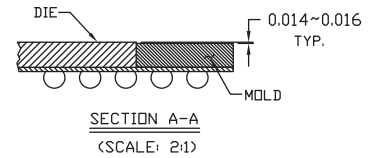

NOTES:

1. ALL DIMENSIONS AND TOLERANCES CONFORM TO ASME Y14.5M-1994
2. SYMBOL "M" IS THE PIN MATRIX SIZE

Figure 5-5: Package Dimensions for UBVA530 (XCZU2, XCZU3)



IMPORTANT: The weight for the UBVA530 is 0.2 grams.

SFVA625 Flip-Chip, Super-Fine-Pitch BGA (XCZU1CG, XCZU1EG, and XAZU1EG)

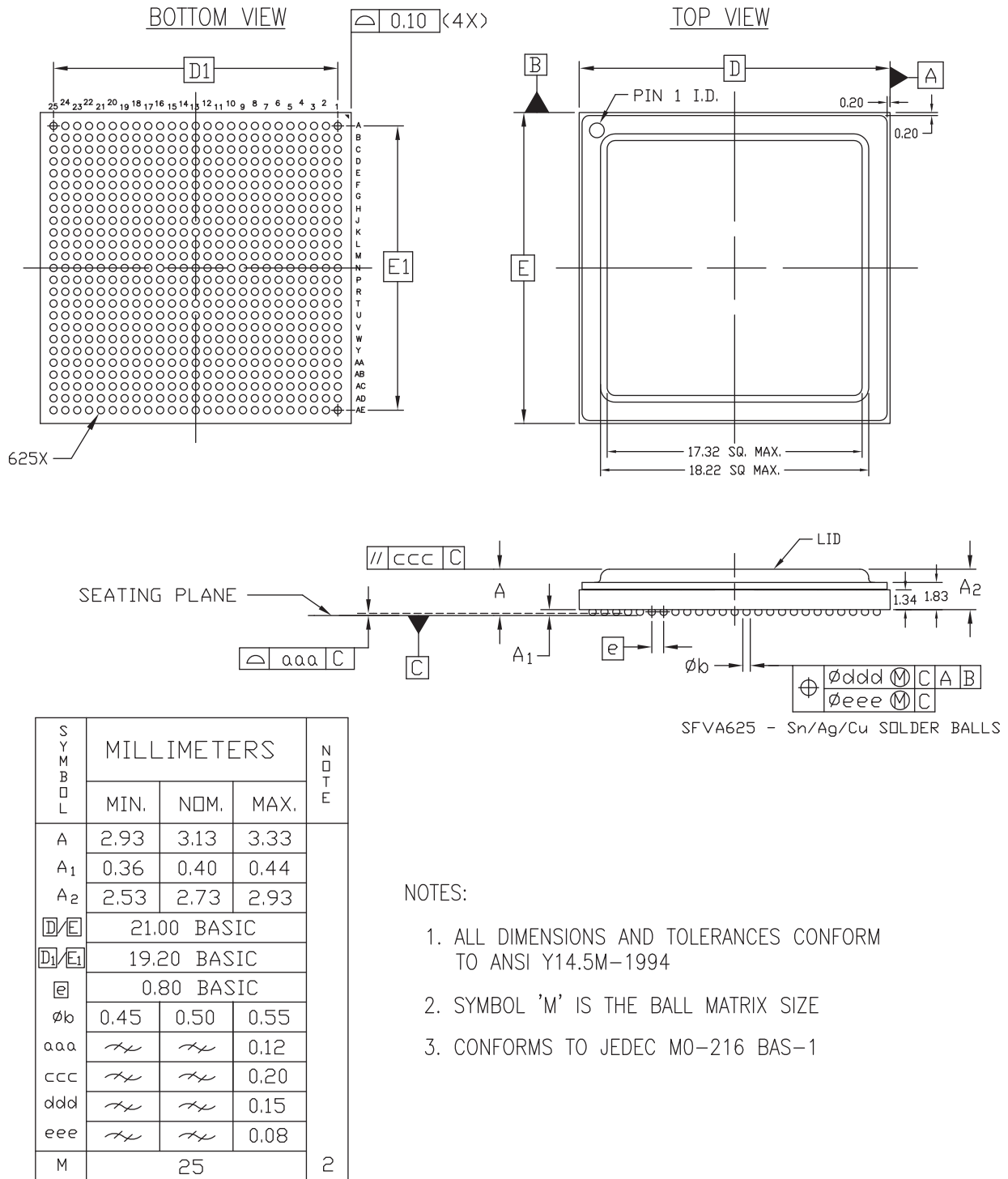
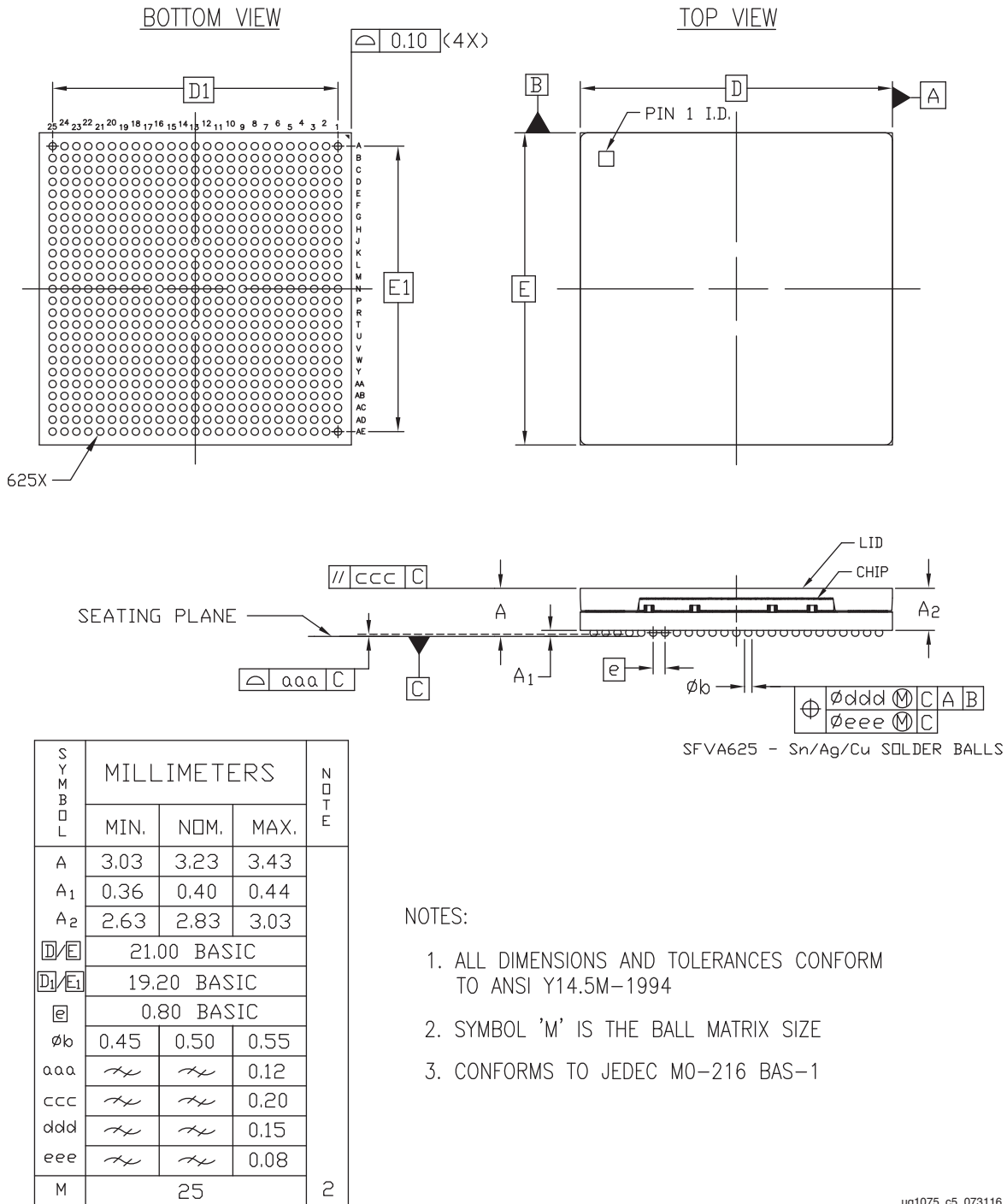

Figure 5-6: Package Dimensions for SFVA625 (XCZU1CG, XCZU1EG, and XAZU1EG)

SFVA625 Flip-Chip, Super-Fine-Pitch BGA (XCZU2, XCZU3, XAZU2EG, and XAZU3EG)



NOTES:

1. ALL DIMENSIONS AND TOLERANCES CONFORM TO ANSI Y14.5M-1994
2. SYMBOL 'M' IS THE BALL MATRIX SIZE
3. CONFORMS TO JEDEC MO-216 BAS-1

ug1075_c5_073116

Figure 5-7: Package Dimensions for SFVA625 (XCZU2, XCZU3, XAZU2EG, and XAZU3EG)

SFRC784 Ruggedized Flip-Chip, Super-Fine-Pitch, BGA (XQZU3EG and XQZU5EV)

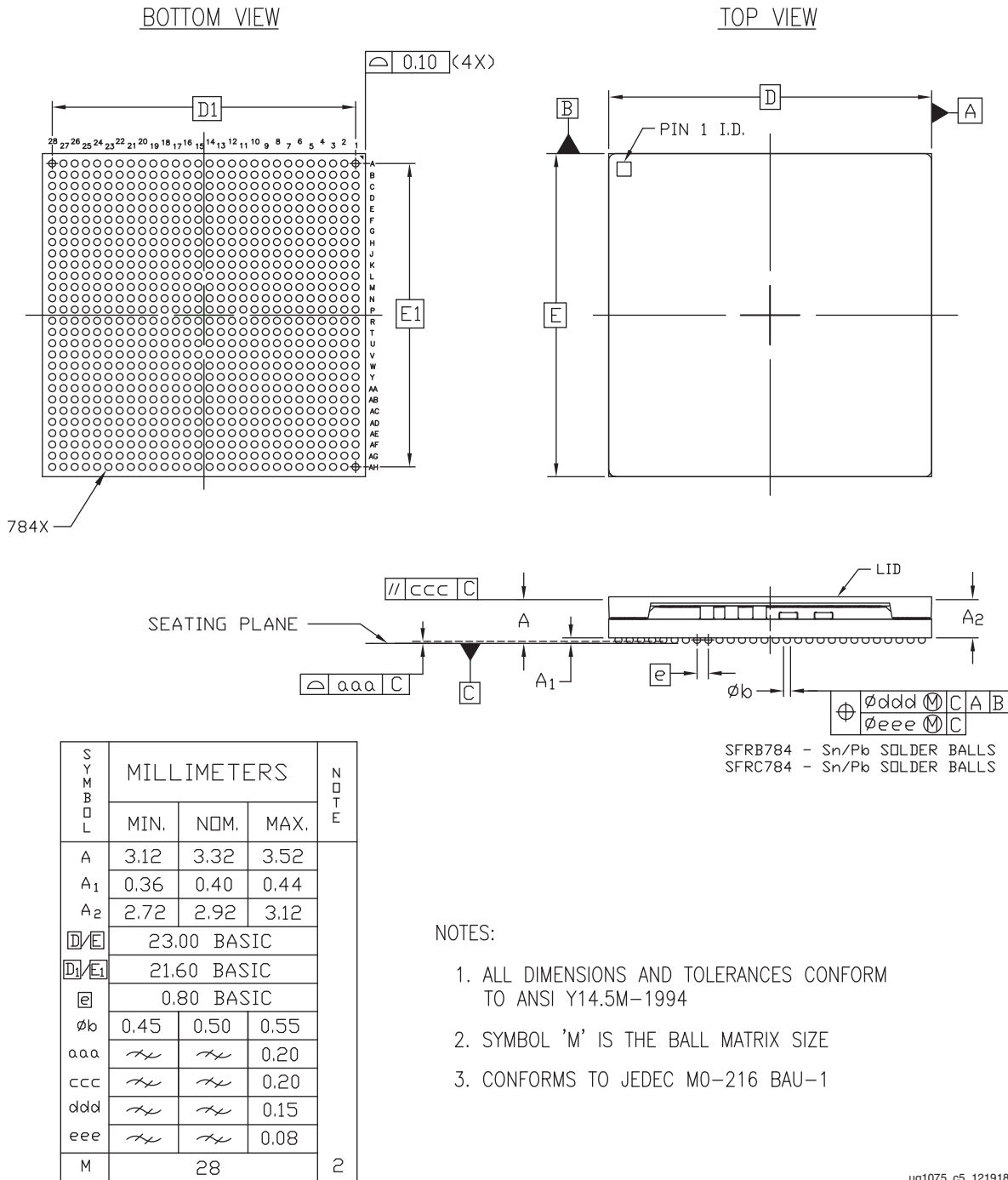
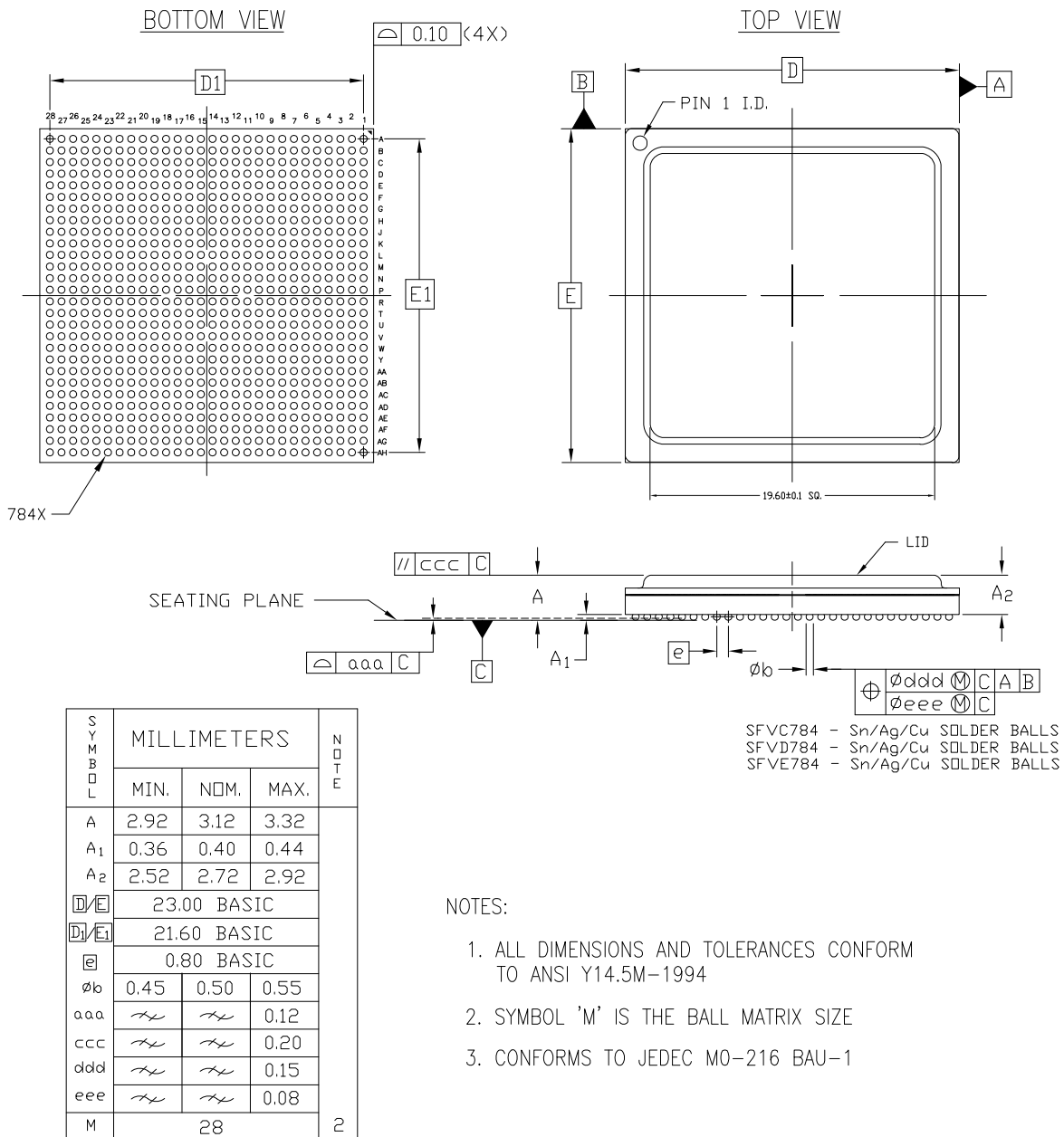

Figure 5-8: Package Dimensions for SFRC784 (XQZU3EG and XQZU5EV)

SFVC784, SFVD784, and SFVE784, Flip-Chip, Super-Fine-Pitch BGA (XCZU1, XAZU1EG, XCZU2, XAZU2EG, XCZU3, XAZU3EG, XCZU3T, XCZU4, XAZU4EV, XCZU5, and XAZU5EV)



X29462-081924

Figure 5-9: Package Dimensions for SFVC784 (XCZU1, XAZU1EG, XCZU2, XAZU2EG, XCZU3, XAZU3EG, XCZU3T, XCZU4, XAZU4EV, XCZU5, and XAZU5EV)

FBVB900 Flip-Chip, Fine-Pitch BGA (XCZU4CG, XCZU4EG, XCZU4EV, XCZU5CG, XCZU5EG, and XCZU5EV)

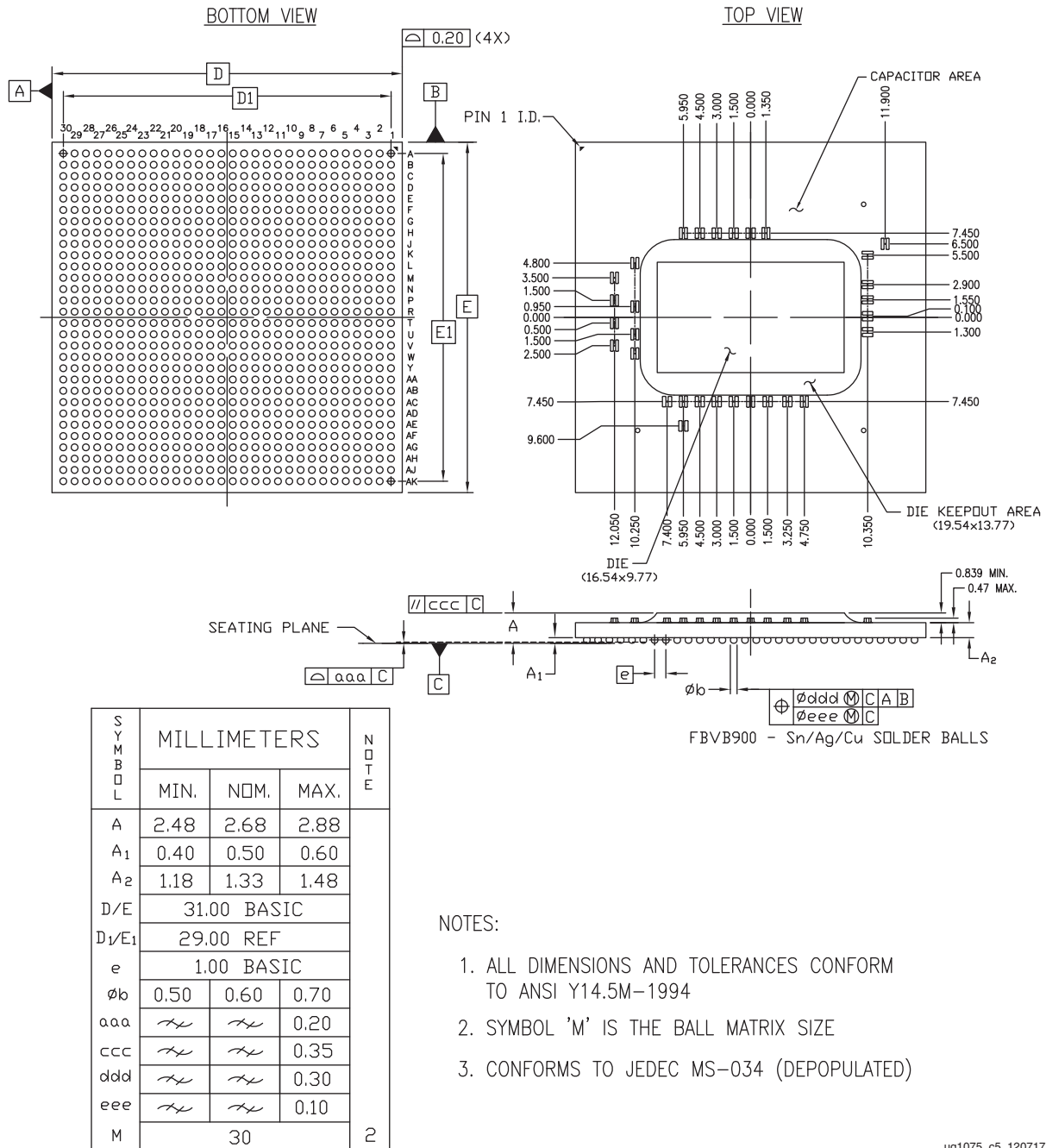

Figure 5-10: Package Dimensions for FBVB900 (XCZU4CG, XCZU4EG, XCZU4EV, XCZU5CG, XCZU5EG, and XCZU5EV)

FBVB900 Flip-Chip, Fine-Pitch BGA (XCZU7CG, XCZU7EG, XCZU7EV, and XAZU7EV)

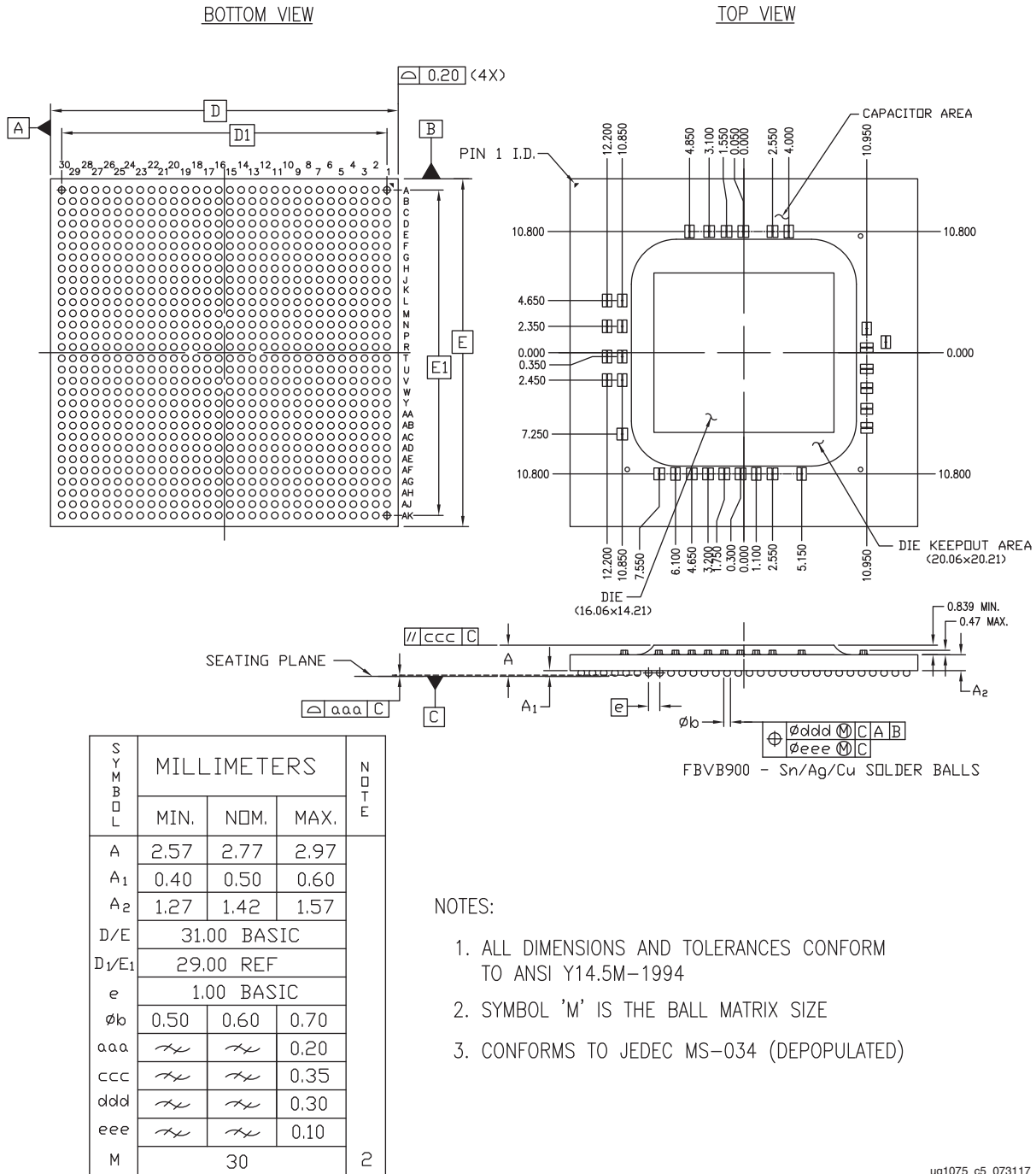

Figure 5-11: Package Dimensions for FBVB900 (XCZU7CG, XCZU7EG, XCZU7EV, and XAZU7EV)

FFRB900 (XQZU7EV) Ruggedized Flip-Chip Fine-Pitch BGA

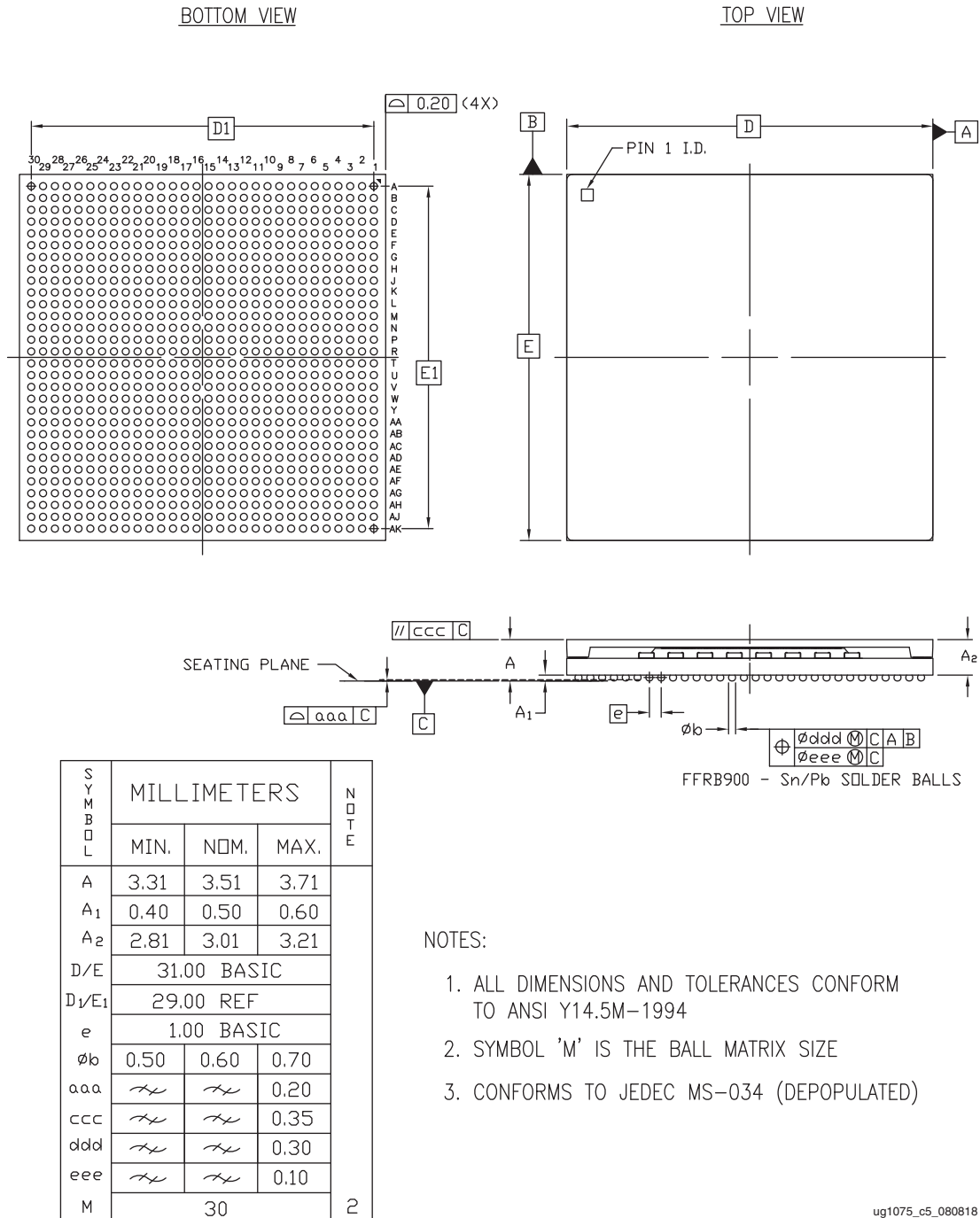
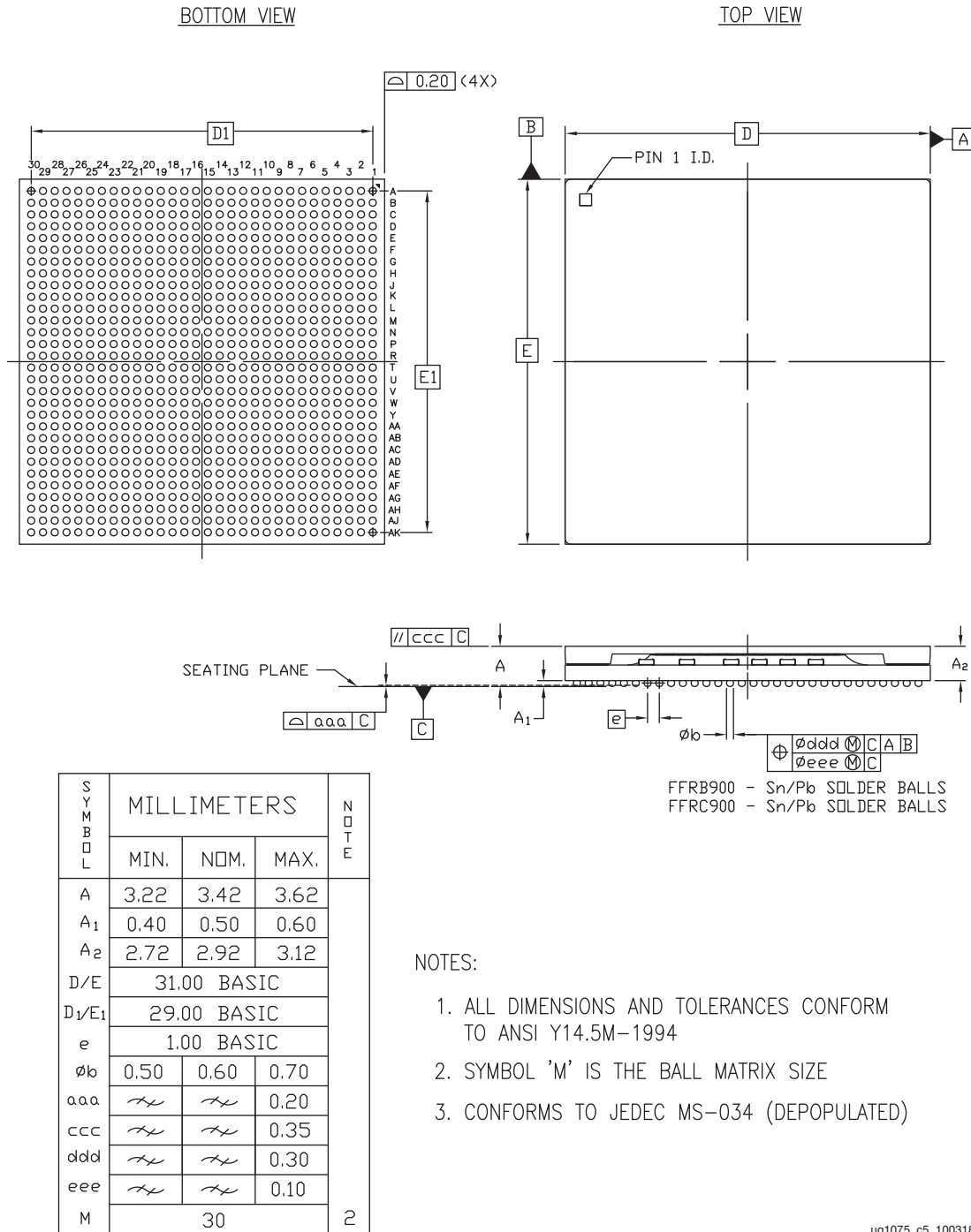

Figure 5-12: Package Dimensions for FFRB900 (XQZU7EV)

FFRB900 (XQZU5EV) and FFRC900 (XQZU9EG and XQZU15EG) Ruggedized Flip-Chip Fine-Pitch BGA



ug1075_c5_100318

Figure 5-13: Package Dimensions for FFRB900 (XQZU5EV) and FFRC900 (XQZU9EG and XQZU15EG)

FFVC900 Flip-Chip, Fine-Pitch BGA (XCZU6CG, XCZU6EG, XCZU9CG, XCZU9EG, and XCZU15EG)

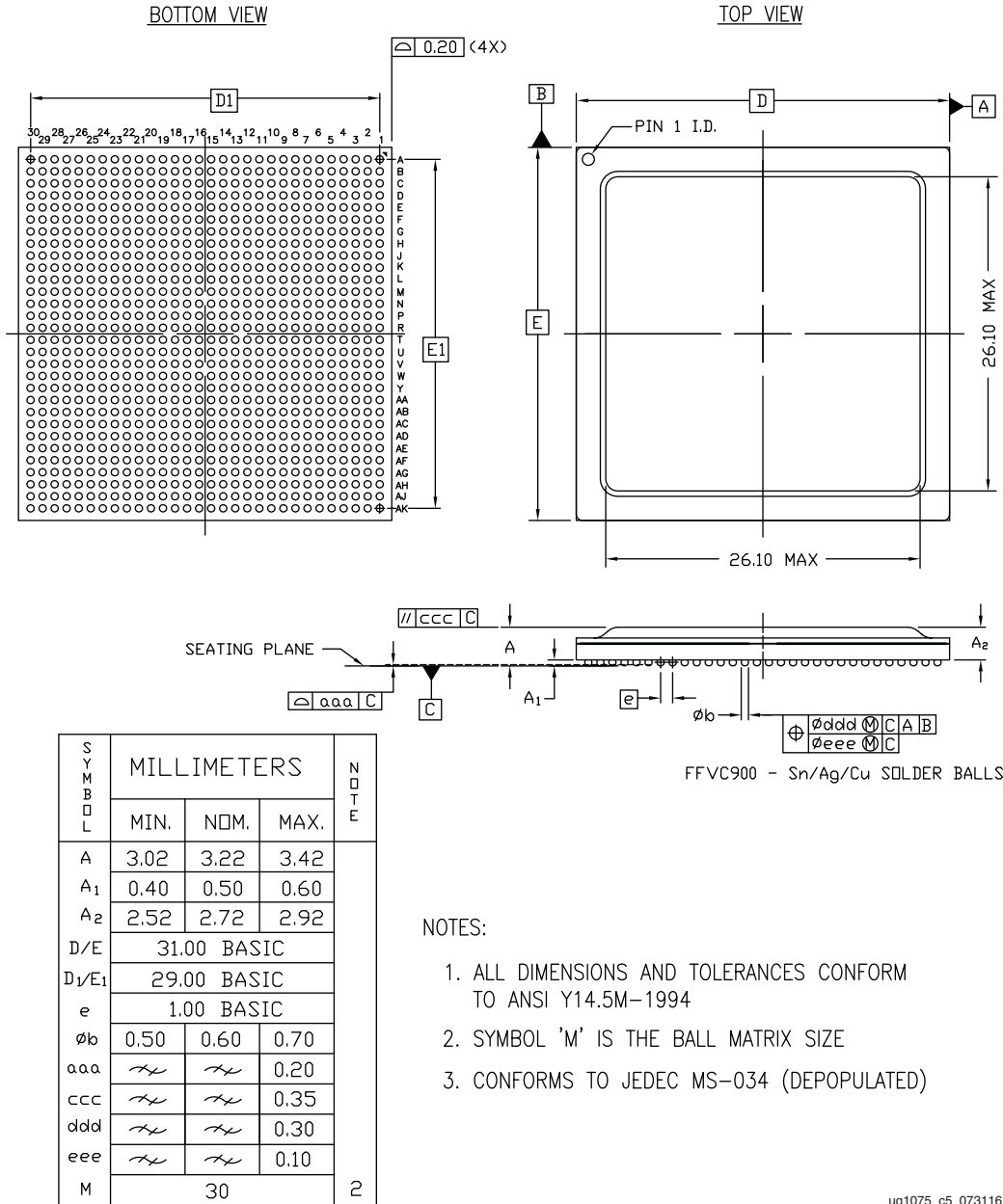

ug1075_c5_073116

Figure 5-14: Package Dimensions for FFVC900 (XCZU6CG, XCZU6EG, XCZU9CG, XCZU9EG, and XCZU15EG)

FFRB1156 Ruggedized Flip-Chip, Fine-Pitch, BGA (XQZU9EG and XQZU15EG)



SYMBOL	MILLIMETERS			NOTE
	MIN.	NOM.	MAX.	
A	3.22	3.42	3.62	
A ₁	0.40	0.50	0.60	
A ₂	2.72	2.92	3.12	
D/E	35.00 BASIC			2
D ₁ /E ₁	33.00 BASIC			
e	1.00 BASIC			
∅b	0.50	0.60	0.70	
aaa	<i>HL</i>	<i>HL</i>	0.20	
ccc	<i>HL</i>	<i>HL</i>	0.35	
ddd	<i>HL</i>	<i>HL</i>	0.30	
eee	<i>HL</i>	<i>HL</i>	0.10	
M	34			

- NOTES:
1. ALL DIMENSIONS AND TOLERANCES CONFORM TO ANSI Y14.5M-1994
 2. SYMBOL 'M' IS THE BALL MATRIX SIZE
 3. CONFORMS TO JEDEC MS-034-AAR-1

ug1075_c5_100318

Figure 5-15: Package Dimensions for FFRB1156 (XQZU9EG and XQZU15EG)

FFVB1156 Flip-Chip, Fine-Pitch BGA (XCZU6CG, XCZU6EG, XCZU9CG, XCZU9EG, and XCZU15EG)

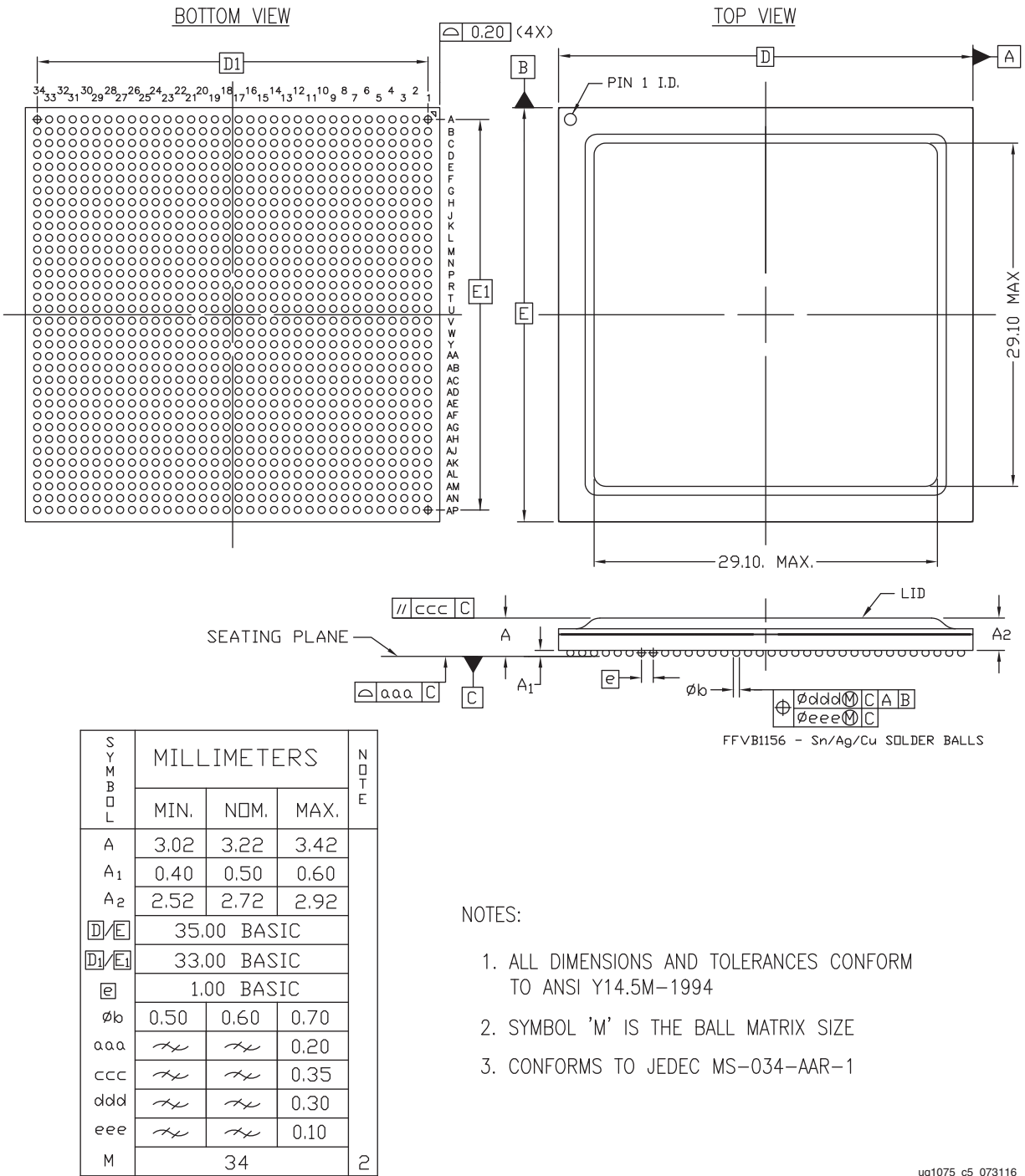
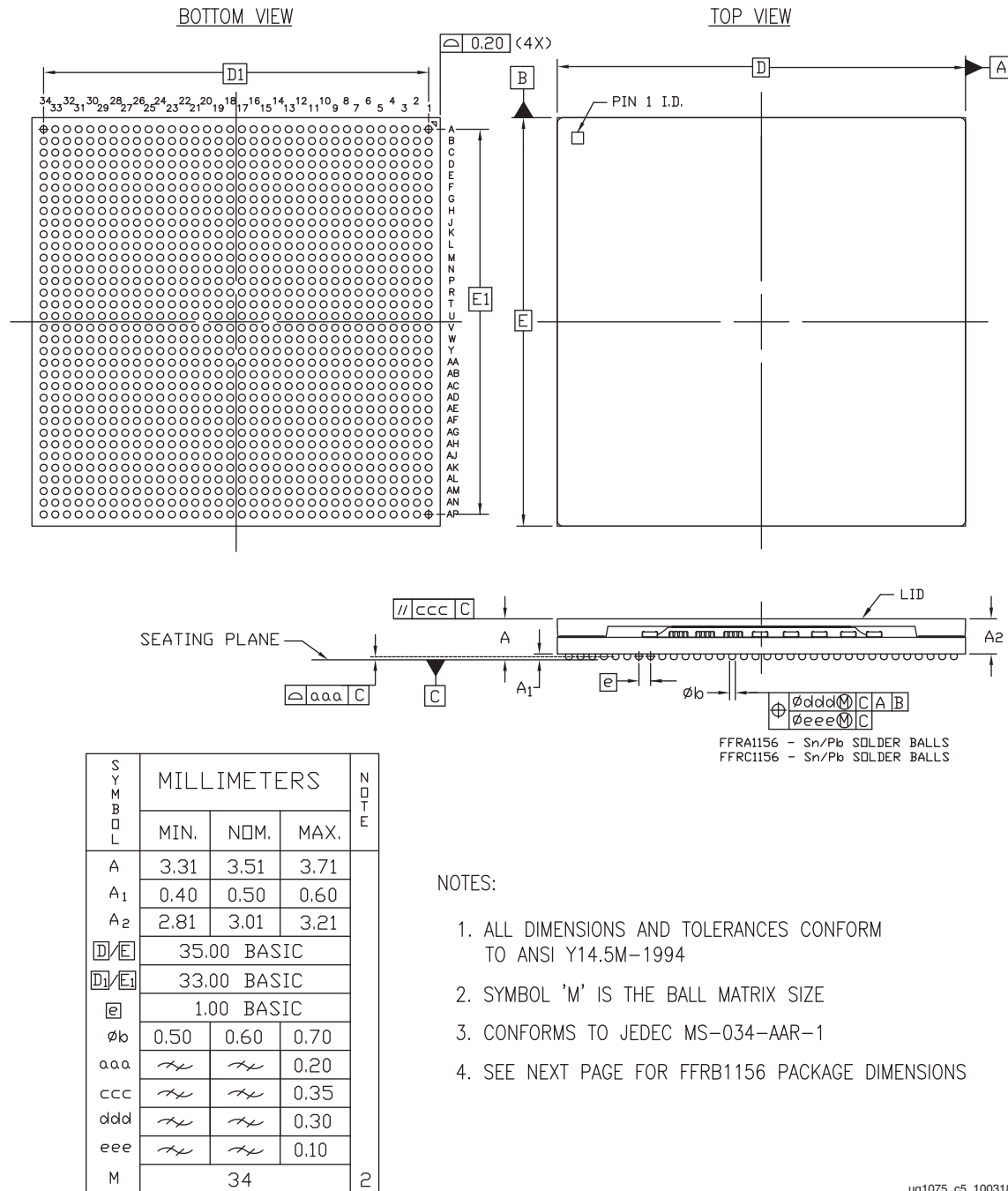

Figure 5-16: Package Dimensions for FFVB1156 (XCZU6CG, XCZU6EG, XCZU9CG, XCZU9EG, and XCZU15EG)

FFRC1156 Ruggedized Flip-Chip Fine-Pitch BGA (XQZU7EV and XQZU11EG)



ug1075_c5_100318

Figure 5-17: Package Dimensions for FFRC1156 (XQZU7EV and XQZU11EG)

FFVC1156 Flip-Chip, Fine-Pitch BGA (XCZU7CG, XCZU7EG, XCZU7EV, and XCZU11EG)

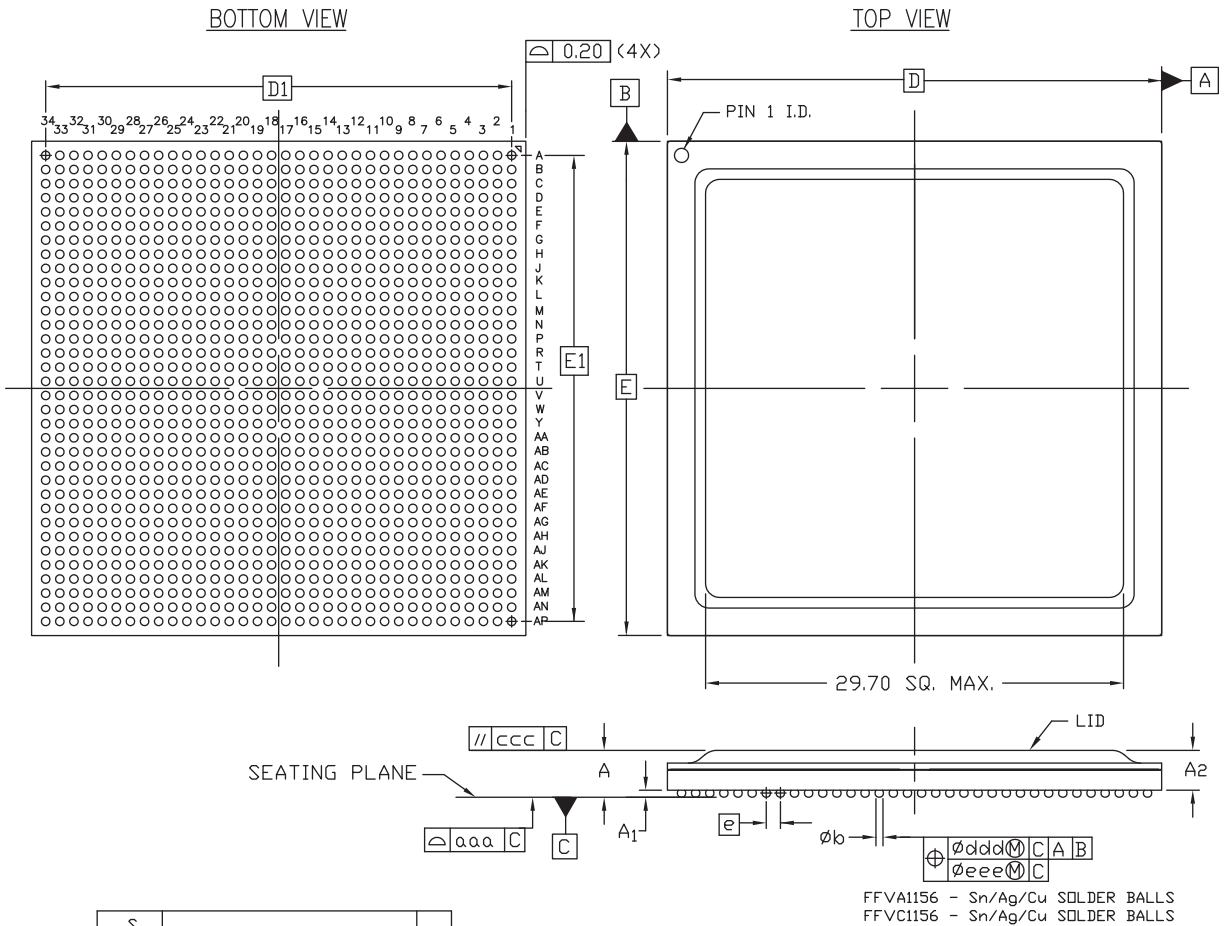

SYMBOL	MILLIMETERS			NOTE
	MIN.	NOM.	MAX.	
A	3.11	3.31	3.51	2
A ₁	0.40	0.50	0.60	
A ₂	2.61	2.81	3.01	
D/E	35.00 BASIC			
D ₁ /E ₁	33.00 BASIC			
e	1.00 BASIC			
øb	0.50	0.60	0.70	
aaa	<i>∕</i>	<i>∕</i>	0.20	
ccc	<i>∕</i>	<i>∕</i>	0.35	
ddd	<i>∕</i>	<i>∕</i>	0.30	
eee	<i>∕</i>	<i>∕</i>	0.10	
M	34			

NOTES:

1. ALL DIMENSIONS AND TOLERANCES CONFORM TO ANSI Y14.5M-1994
2. SYMBOL 'M' IS THE BALL MATRIX SIZE
3. CONFORMS TO JEDEC MS-034-AAR-1

ug1075_c5_073116

Figure 5-18: Package Dimensions for FFVC1156 (XCZU7CG, XCZU7EG, XCZU7EV, and XCZU11EG)

FFRD1156 (XQZU21DR) Ruggedized Flip-Chip Fine-Pitch BGA

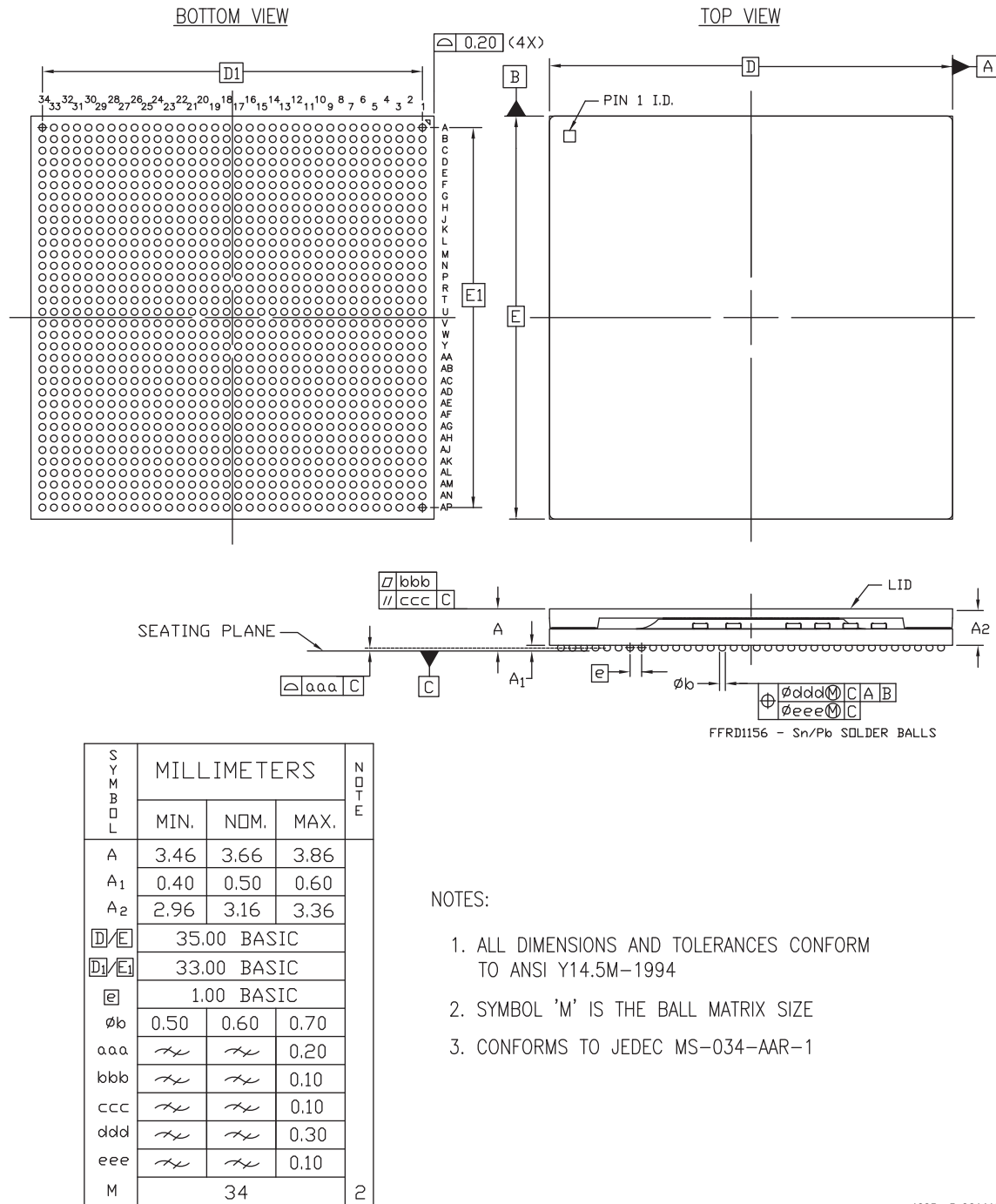

ug1085_c5_061419

Figure 5-19: Package Dimensions for FFRD1156 (XQZU21DR)

FFRE1156 (XQZU28DR, XQZU48DR) Ruggedized Flip-Chip Fine-Pitch BGA

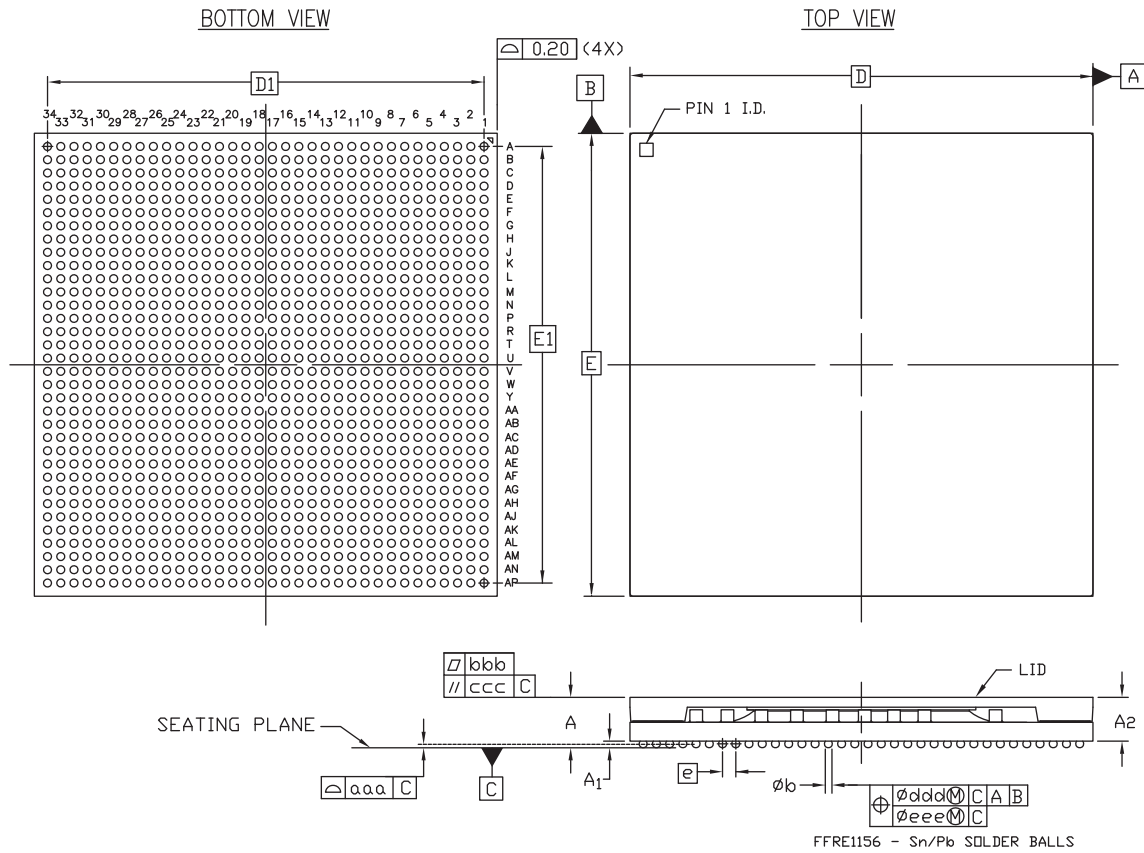

SYMBOL	MILLIMETERS			NOTE
	MIN.	NOM.	MAX.	
A	3.61	3.81	4.01	
A ₁	0.40	0.50	0.60	
A ₂	3.11	3.31	3.51	
D/E	35.00 BASIC			
D ₁ /E ₁	33.00 BASIC			
e	1.00 BASIC			
phi b	0.50	0.60	0.70	
aaa	<i>HL</i>	<i>HL</i>	0.20	
bbb	<i>HL</i>	<i>HL</i>	0.10	
ccc	<i>HL</i>	<i>HL</i>	0.10	
ddd	<i>HL</i>	<i>HL</i>	0.30	
eee	<i>HL</i>	<i>HL</i>	0.10	
M	34			2

NOTES:

1. ALL DIMENSIONS AND TOLERANCES CONFORM TO ANSI Y14.5M-1994
2. SYMBOL 'M' IS THE BALL MATRIX SIZE
3. CONFORMS TO JEDEC MS-034-AAR-1

ug1085_c5_061419

Figure 5-20: Package Dimensions for FFRE1156 (XQZU28DR and XQZU48DR)

FFVD1156 (XCZU21DR) and FFVE1156 (XCZU25DR, XCZU27DR, XCZU42DR, XCZU48DR, XCZU63DR, XCZU64DR, XCZU65DR, XCZU67DR) Flip-Chip, Fine-Pitch BGA

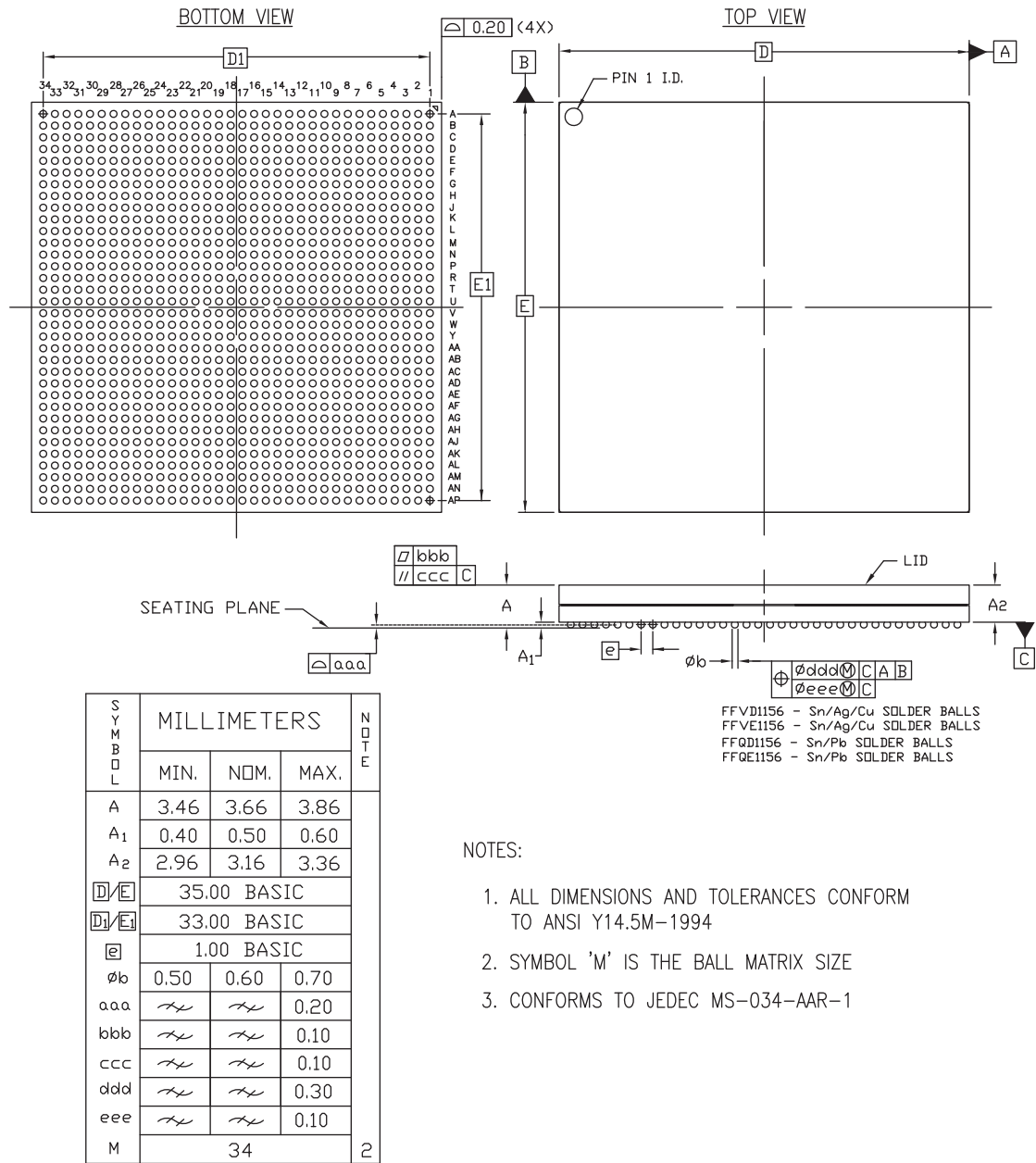

Figure 5-21: Package Dimensions for FFVE1156 (XCZU21DR) and FFVE1156 (XCZU25DR, XCZU27DR, XCZU28DR, XCZU42DR, XCZU43DR, XCZU47DR, XCZU48DR, XCZU63DR, XCZU64DR, XCZU65DR, XCZU67DR)

FSVE1156 (XCZU25DR, XCZU27DR, XCZU28DR, XCZU43DR, XCZU47DR, XCZU48DR) Flip-Chip, Fine-Pitch, Lidless w/Stiffener Ring BGA

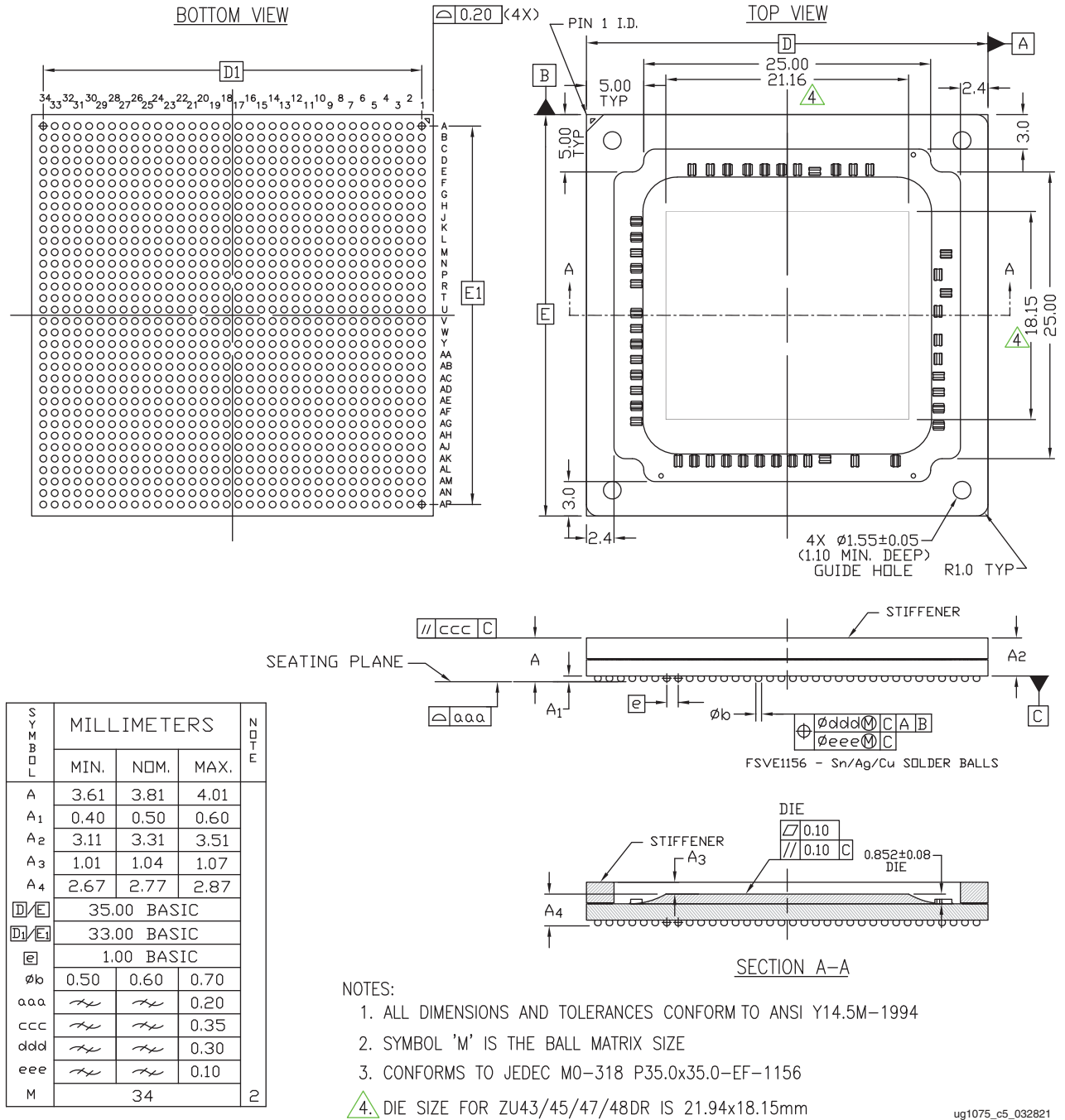

Figure 5-22: Package Dimensions for FSVE1156 (XCZU25DR, XCZU27DR, XCZU28DR, XCZU43DR, XCZU47DR, XCZU48DR)

FSVE1156 (XCZU42DR, XCZU63DR, XCZU64DR, XCZU65DR, XCZU67DR) Flip-Chip, Fine-Pitch, Lidless w/Stiffener Ring BGA

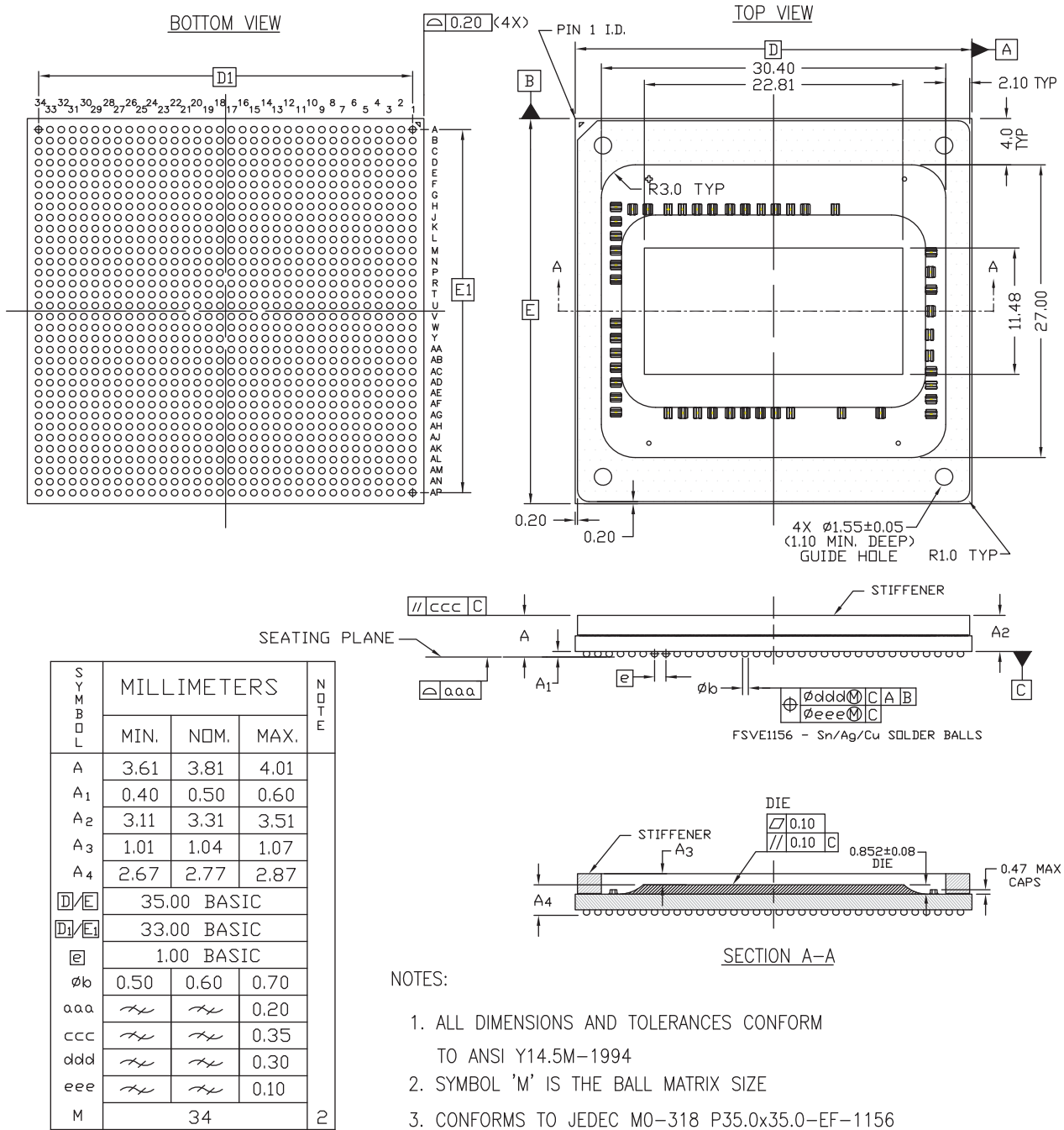

Figure 5-23: Package Dimensions for FSVE1156 (XCZU42DR, XCZU63DR, XCZU64DR, XCZU65DR, XCZU67DR)

FFRB1517 (XQZU19EG) Ruggedized Flip-Chip Fine-Pitch BGA

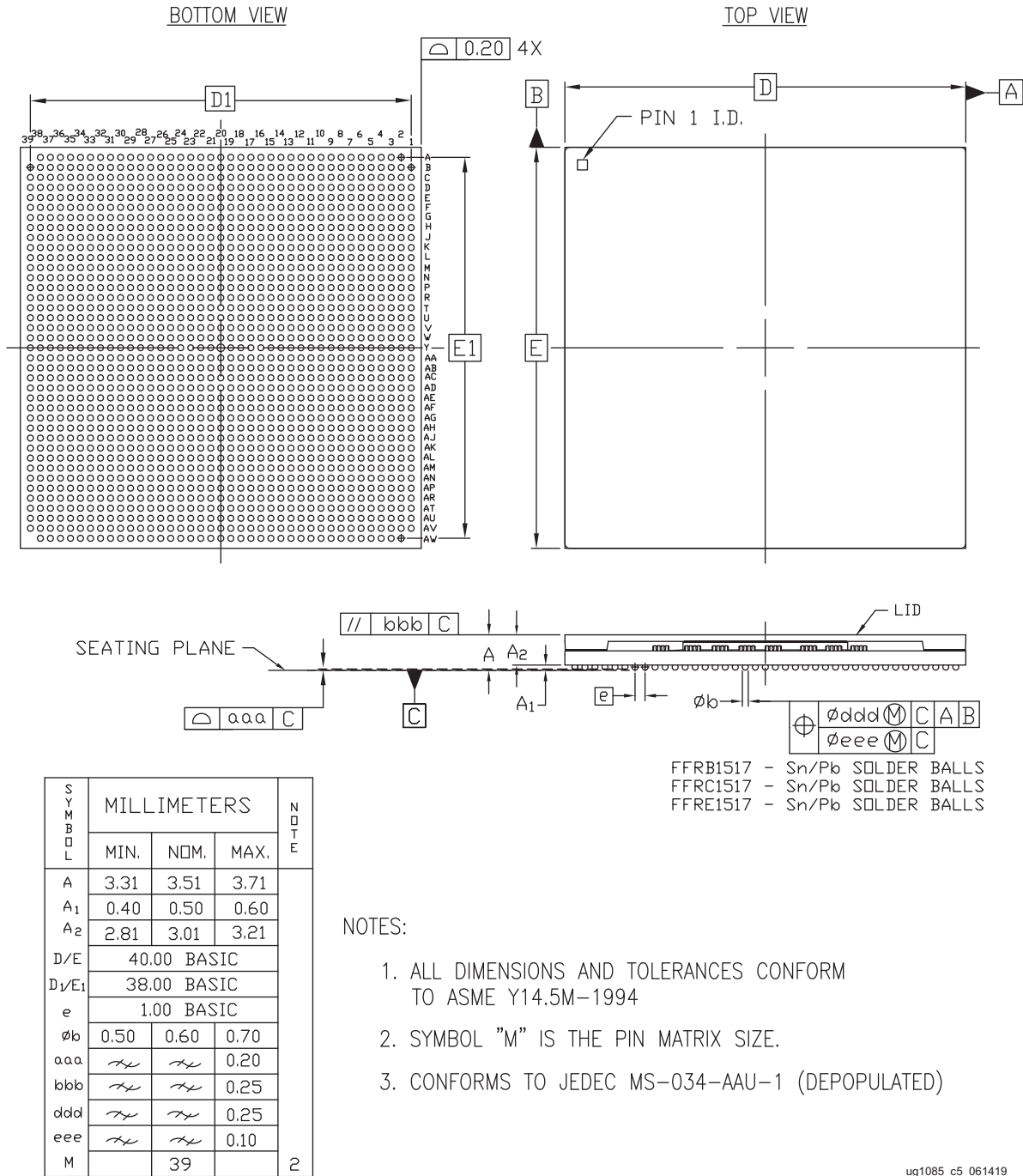

Figure 5-24: Package Dimensions for FFRB1517 (XQZU19EG)

FFVB1517 (XCZU11EG, XCZU17EG, and XCZU19EG) and FFVF1517 (XCZU7CG, XCZU7EG, XCZU7EV, XCZU11EG, and XAZU11EG) Flip-Chip, Fine-Pitch BGA

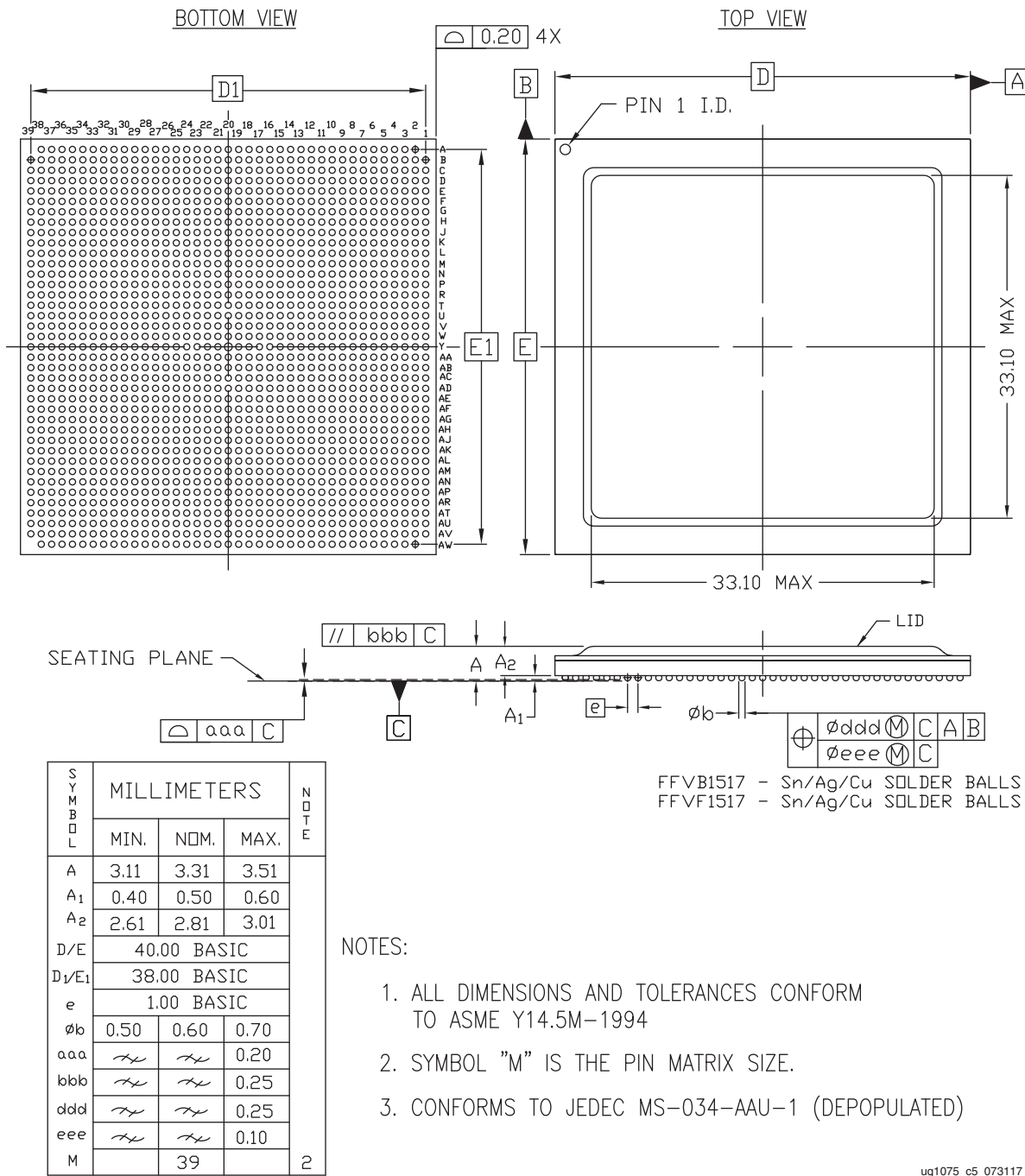
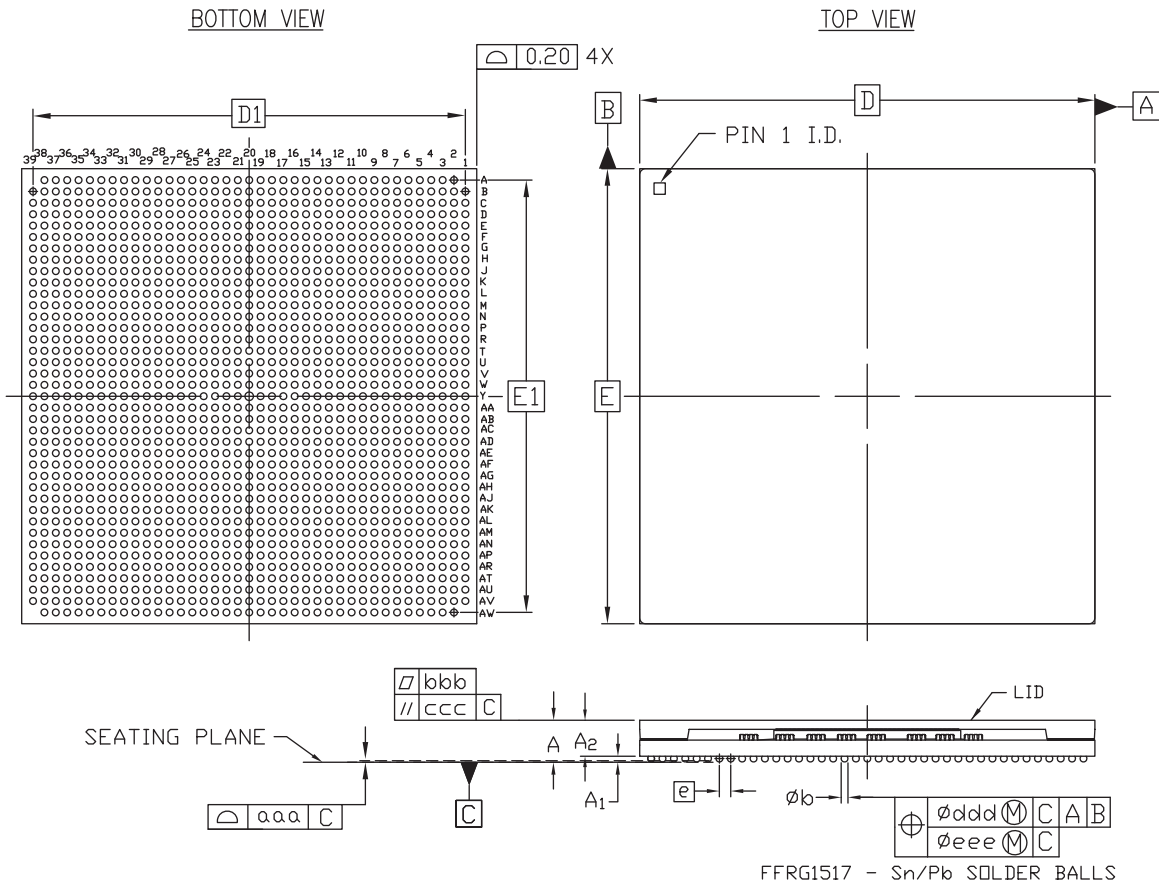

Figure 5-25: Package Dimensions for FFVB1517 (XCZU11EG, XCZU17EG, and XCZU19EG) and FFVF1517 (XCZU7CG, XCZU7EG, XCZU7EV, XCZU11EG, and XAZU11EG)

FFRG1517 (XQZU28DR) Ruggedized Flip-Chip Fine-Pitch BGA



SYMBOL	MILLIMETERS			NOTE
	MIN.	NOM.	MAX.	
A	3.46	3.66	3.86	
A ₁	0.40	0.50	0.60	
A ₂	2.96	3.16	3.36	
D/E	40.00 BASIC			
D ₁ /E ₁	38.00 BASIC			
e	1.00 BASIC			
phi b	0.50	0.60	0.70	
aaa	<i>Handwritten</i>	<i>Handwritten</i>	0.20	
bbb	<i>Handwritten</i>	<i>Handwritten</i>	0.10	
ccc	<i>Handwritten</i>	<i>Handwritten</i>	0.10	
ddd	<i>Handwritten</i>	<i>Handwritten</i>	0.25	
eee	<i>Handwritten</i>	<i>Handwritten</i>	0.10	
M		39		2

NOTES:

1. ALL DIMENSIONS AND TOLERANCES CONFORM TO ASME Y14.5M-1994
2. SYMBOL "M" IS THE PIN MATRIX SIZE.
3. CONFORMS TO JEDEC MS-034-AAU-1 (DEPOPULATED)

ug1085_c5_061419

Figure 5-26: Package Dimensions for FFRG1517 (XQZU28DR)

FFVG1517 (XCZU25DR, XCZU27DR, XCZU28DR, XCZU43DR, XCZU47DR, XCZU48DR) Flip-Chip, Fine-Pitch BGA

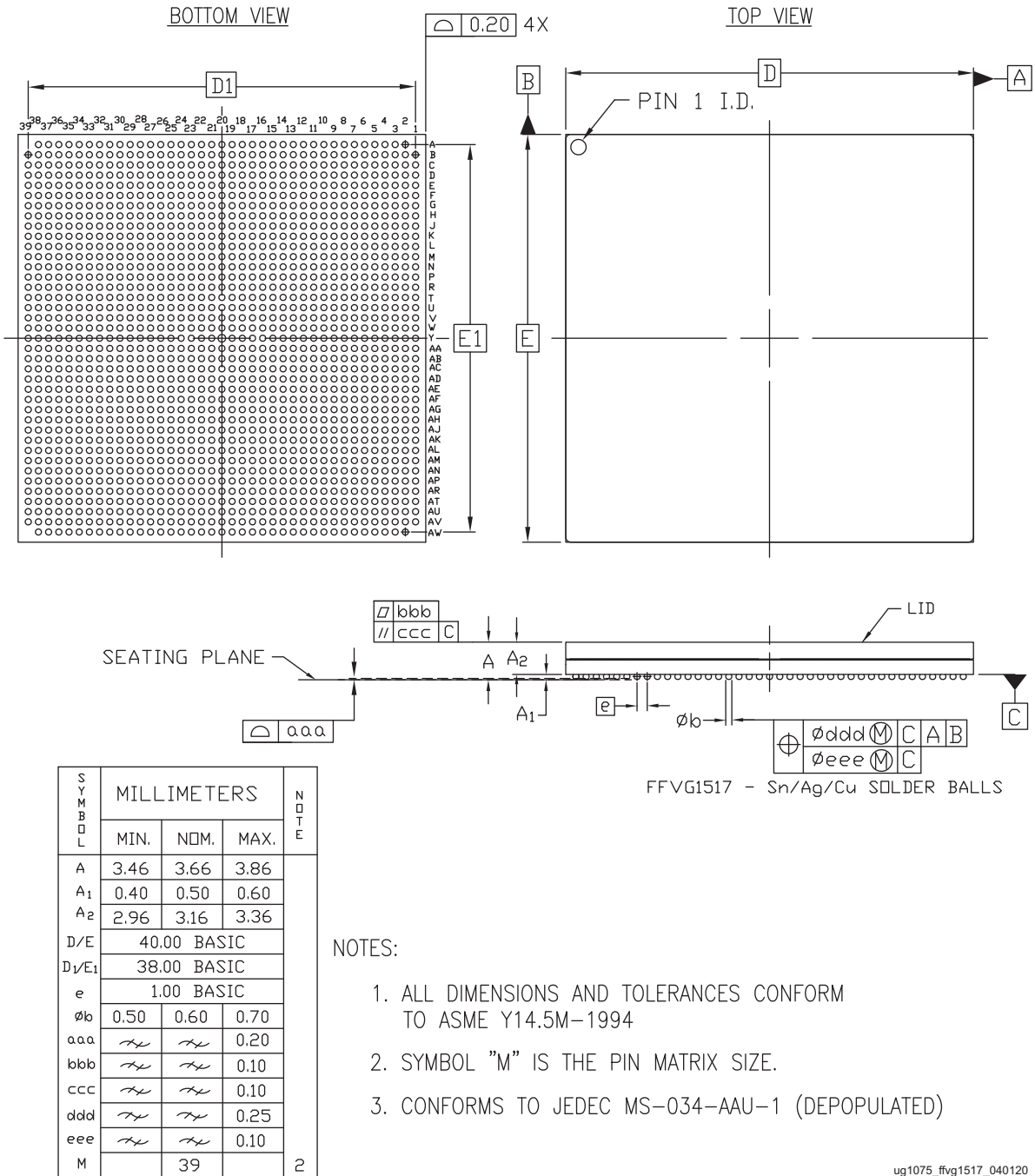

Figure 5-27: Package Dimensions for FFVG1517 (XCZU25DR, XCZU27DR, XCZU28DR, XCZU43DR, XCZU47DR, XCZU48DR)

FSRG1517 (XQZU48DR) Ruggedized Flip Chip, Fine-Pitch, Lidless with Stiffener Ring BGA

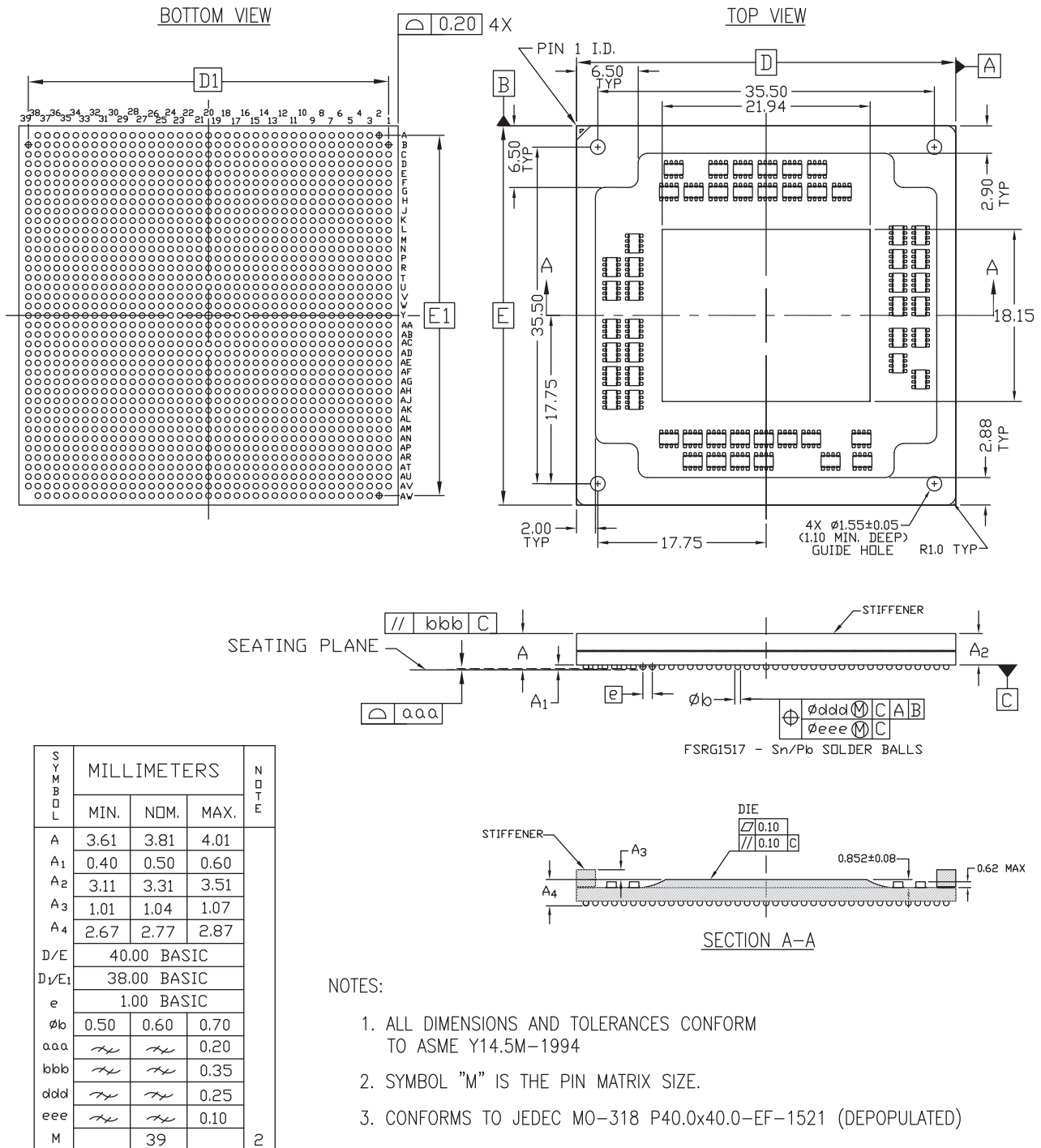
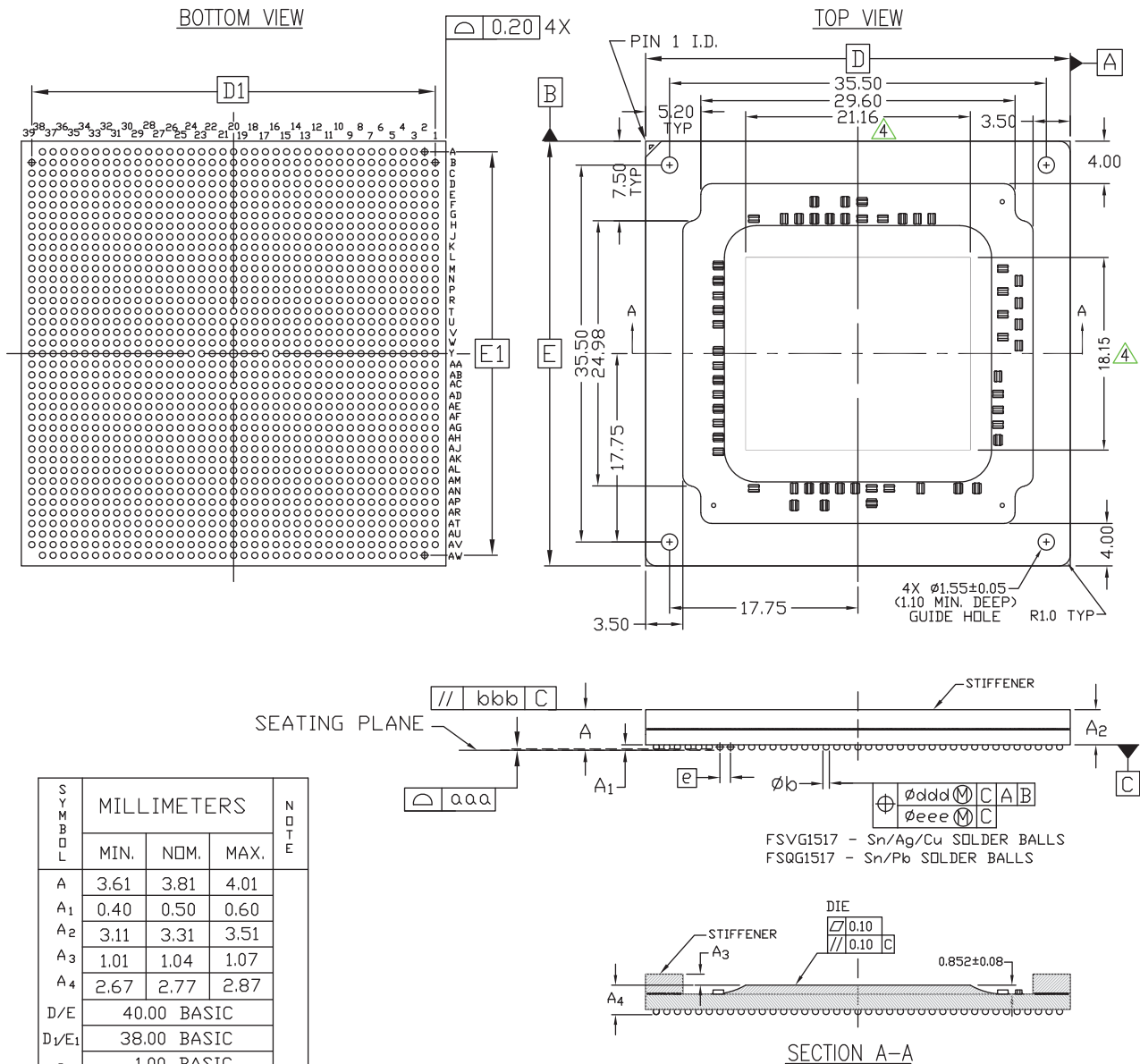

Figure 5-28: Package Dimensions for FSRG1517 (XQZU48DR)

FSVG1517 (XCZU25DR, XCZU27DR, XCZU28DR, XCZU43DR, XCZU47DR, XCZU48DR) Flip-Chip, Fine-Pitch, Lidless with Stiffener Ring BGA



NOTES:

1. ALL DIMENSIONS AND TOLERANCES CONFORM TO ASME Y14.5M-1994
2. SYMBOL "M" IS THE PIN MATRIX SIZE.
3. CONFORMS TO JEDEC MO-318 P40.0x40.0-EF-1521 (DEPOPULATED)

4. DIE SIZE FOR XCZU4*DR IS (21.94 X 18.15mm)

ug1075_c5_032821

Figure 5-29: Package Dimensions for FSVG1517 (XCZU25DR, XCZU27DR, XCZU28DR, XCZU43DR, XCZU47DR, XCZU48DR)

FFVC1760 and FFVD1760 Flip-Chip, Fine-Pitch BGA (XCZU11EG, XCZU17EG, and XCZU19EG)

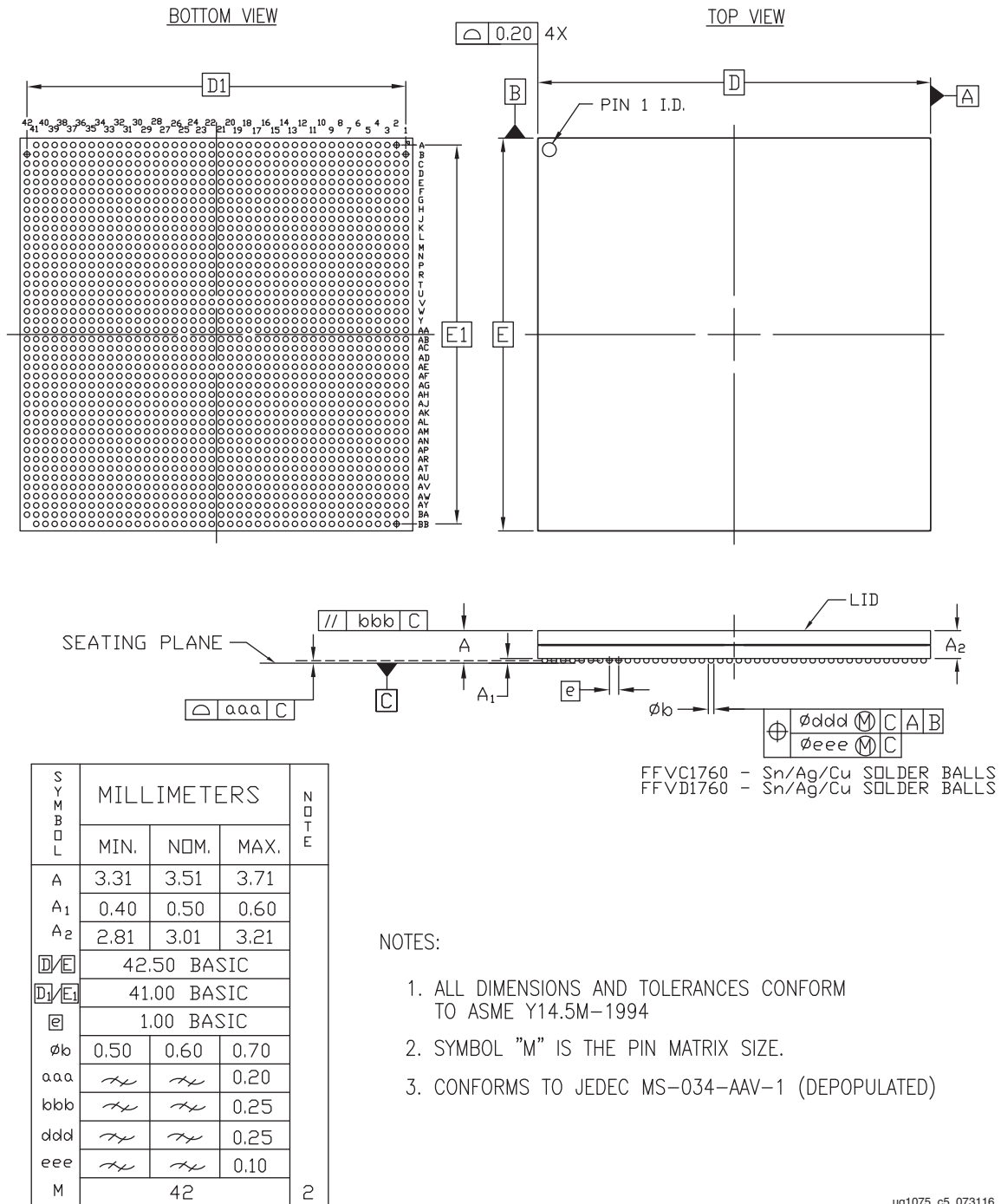

ug1075_c5_073116

Figure 5-30: Package Dimensions for FFVC1760 and FFVD1760 (XCZU11EG, XCZU17EG, and XCZU19EG)

FFRC1760 Ruggedized Flip-Chip BGA (XQZU11EG and XQZU19EG)

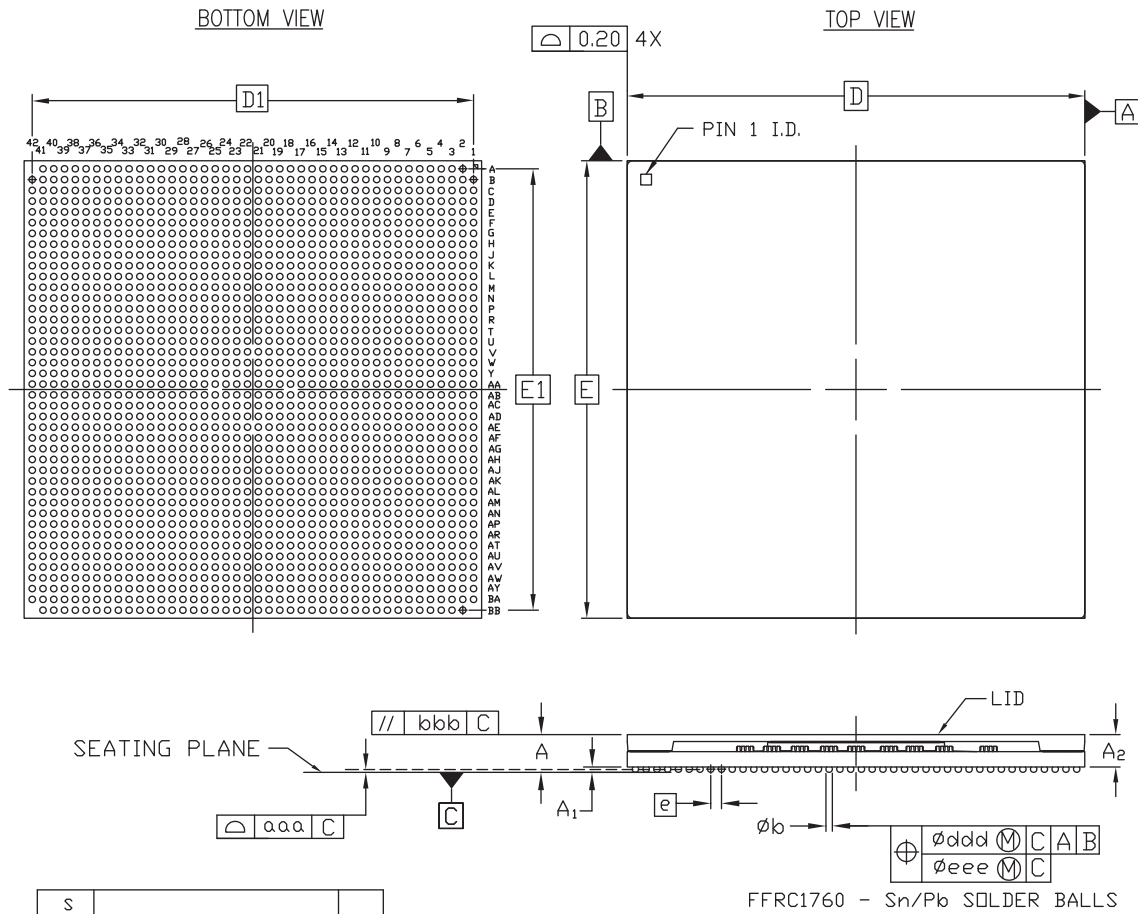

SYMBOL	MILLIMETERS			NOTE
	MIN.	NOM.	MAX.	
A	3.31	3.51	3.71	2
A ₁	0.40	0.50	0.60	
A ₂	2.81	3.01	3.21	
D/E	42.50 BASIC			
D ₁ /E ₁	41.00 BASIC			
e	1.00 BASIC			
ϕb	0.50	0.60	0.70	
aaa	$\cancel{\text{---}}$	$\cancel{\text{---}}$	0.20	
bbb	$\cancel{\text{---}}$	$\cancel{\text{---}}$	0.25	
ddd	$\cancel{\text{---}}$	$\cancel{\text{---}}$	0.25	
eee	$\cancel{\text{---}}$	$\cancel{\text{---}}$	0.10	
M	42			

NOTES:

1. ALL DIMENSIONS AND TOLERANCES CONFORM TO ASME Y14.5M-1994
2. SYMBOL "M" IS THE PIN MATRIX SIZE.
3. CONFORMS TO JEDEC MS-034-AAV-1 (DEPOPULATED)

ug1085_c5_061419

Figure 5-31: Package Dimensions for FFRC1760 (XQZU11EG and XQZU19EG)

FFVF1760 (XCZU29DR, XCZU39DR, XCZU49DR) and FFVH1760 (XCZU46DR) Flip-Chip, Fine-Pitch BGA

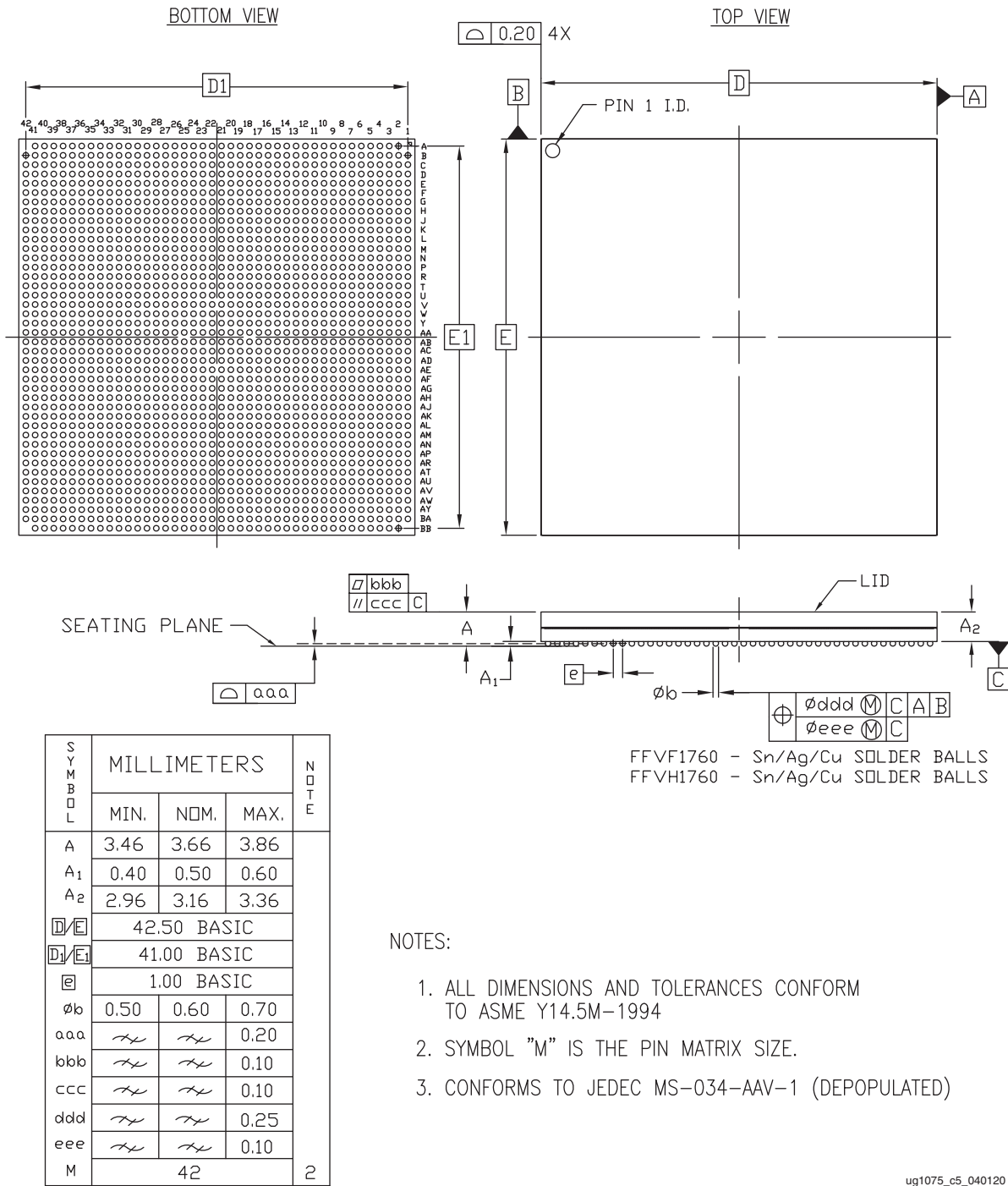

ug1075_c5_040120

Figure 5-32: Package Dimensions for FFVF1760 (XCZU29DR, XCZU39DR, XCZU49DR) and FFVH1760 (XCZU46DR)

FFRF1760 (XQZU29DR) Ruggedized Flip-Chip Fine-Pitch BGA

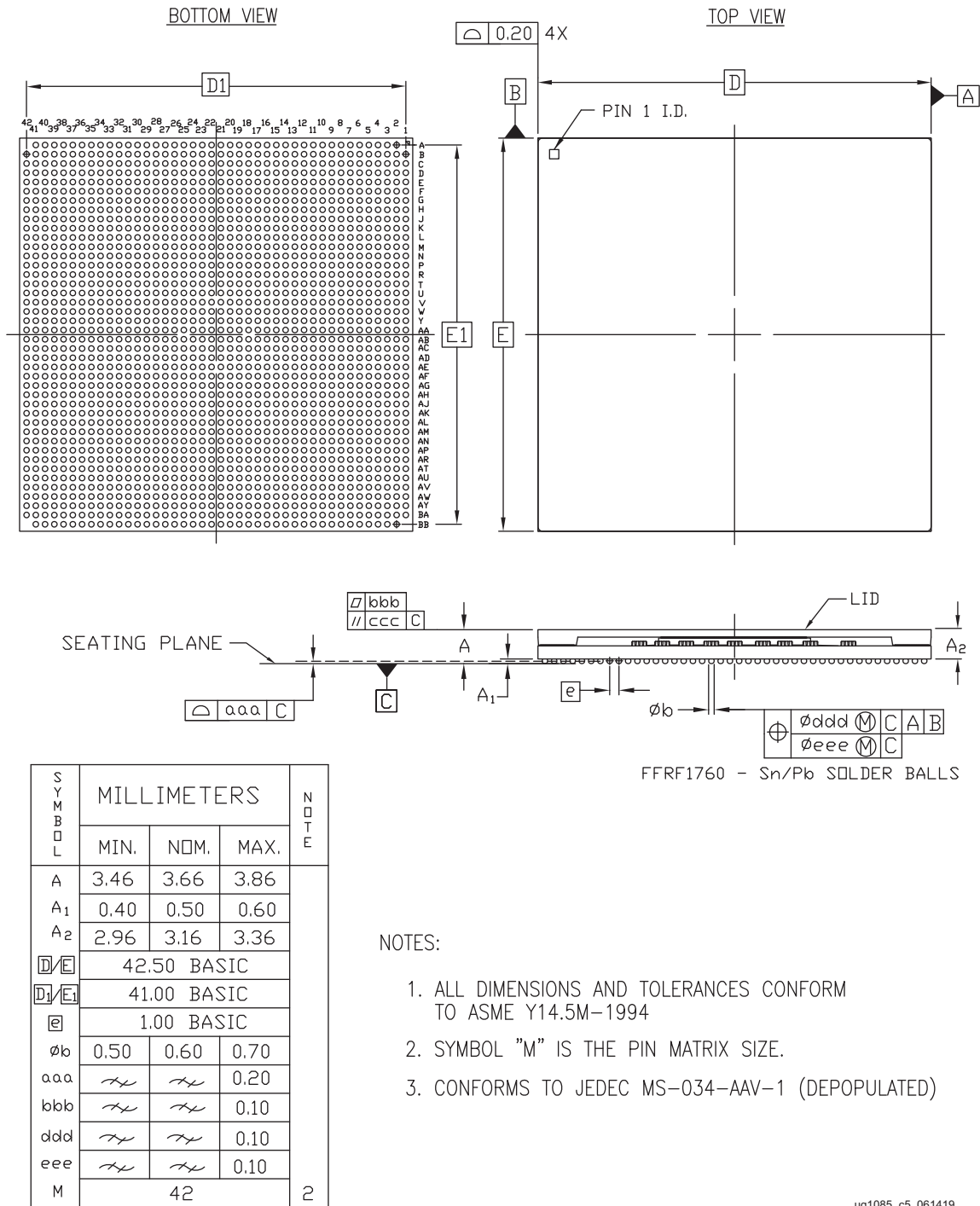
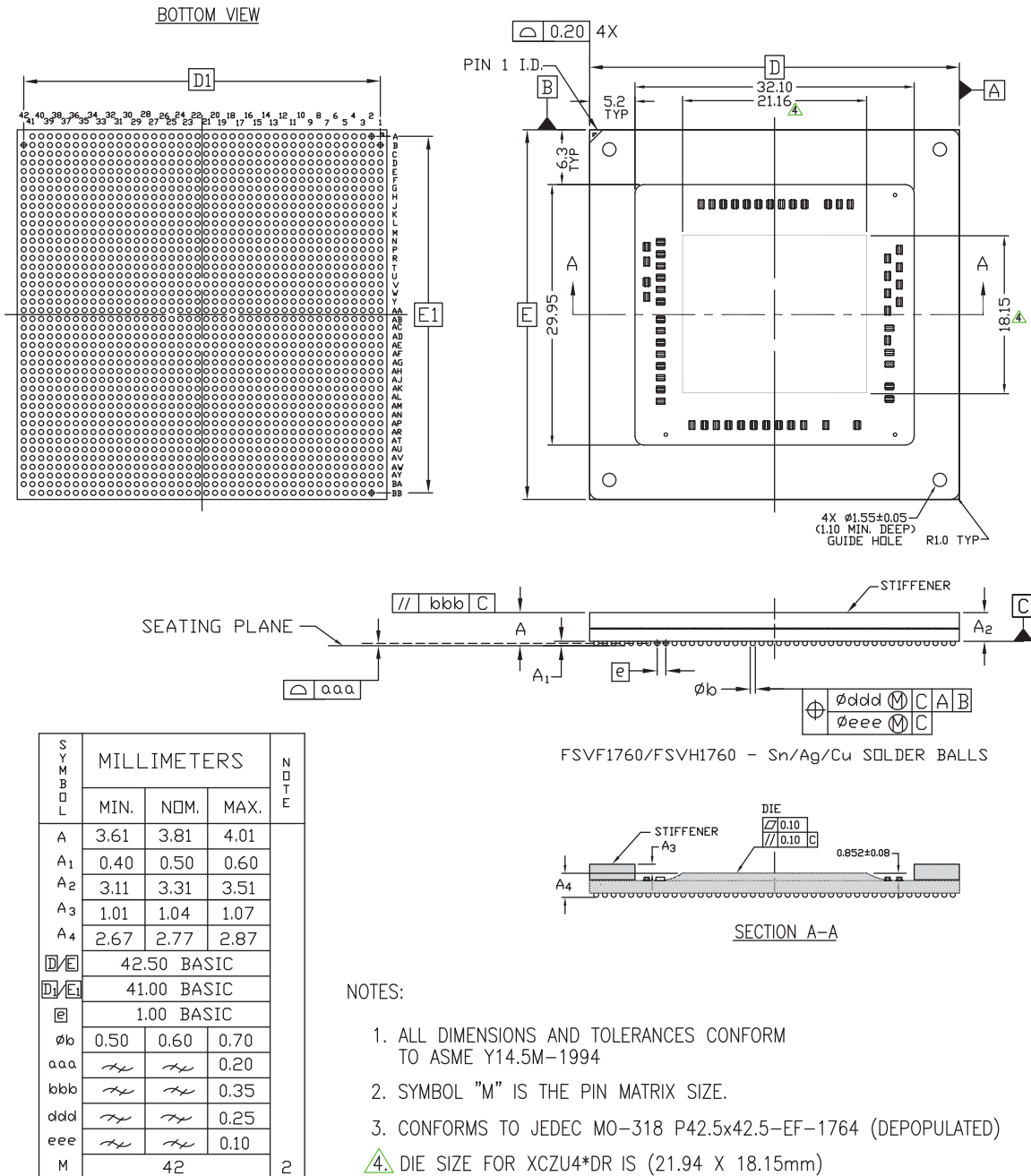

Figure 5-33: Package Dimensions for FFRF1760 (XQZU29DR)

FSVF1760 (XCZU29DR, XCZU39DR, XCZU49DR) and FSVH1760 (XCZU46DR) Flip-Chip, Fine-Pitch, Lidless with Stiffener Ring BGA



ug1075_c5_010421

Figure 5-34: Package Dimensions for FSVF1760 (XCZU29DR, XCZU39DR, XCZU49DR) and FSVH1760 (XCZU46DR)

FSRF1760 (XQZU49DR) Ruggedized Flip Chip, Fine-Pitch Lidless with Stiffener Ring BGA

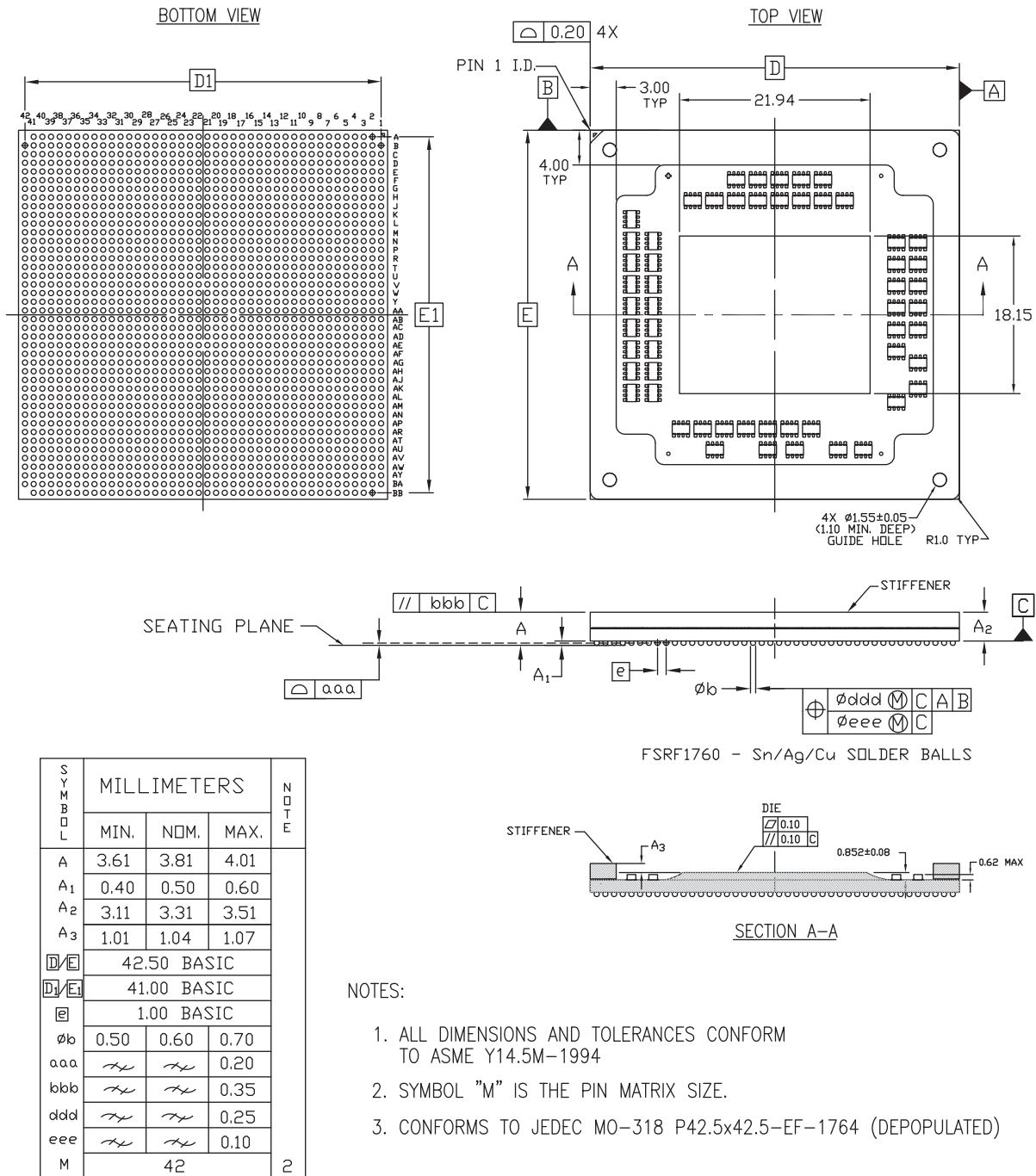
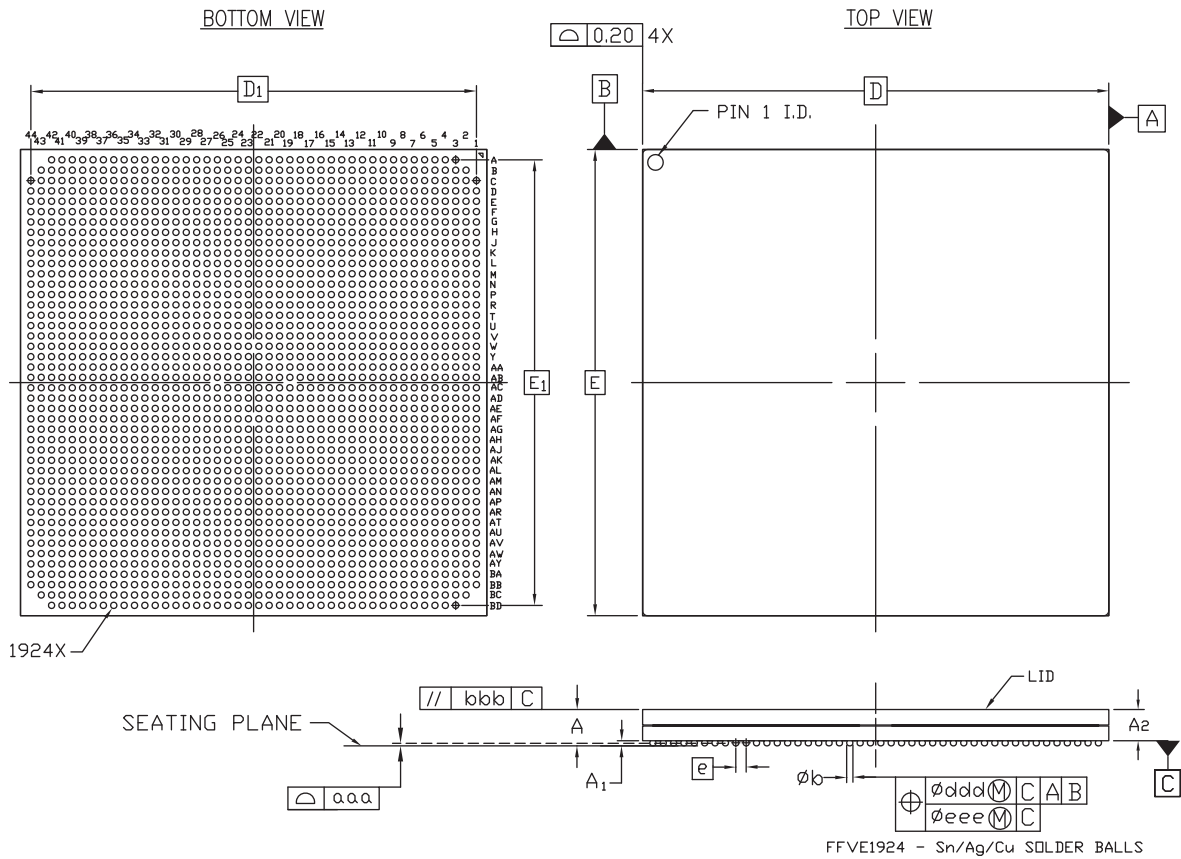

Figure 5-35: Package Dimensions for FSRF1760 (XQZU49DR)

FFVE1924 Flip-Chip, Fine-Pitch BGA (XCZU17EG, and XCZU19EG)



SYMBOL	MILLIMETERS			NOTE
	MIN.	NOM.	MAX.	
A	3.31	3.51	3.71	3
A ₁	0.40	0.50	0.60	
A ₂	2.81	3.01	3.21	
D/E	45.00 BASIC			2
D ₁ /E ₁	43.00 REF			
e	1.00 BASIC			
øb	0.50	0.60	0.70	
aaa	<i>∅</i>	<i>∅</i>	0.20	
bbb	<i>∅</i>	<i>∅</i>	0.10	
ddd	<i>∅</i>	<i>∅</i>	0.25	
eee	<i>∅</i>	<i>∅</i>	0.10	
M	44			

NOTES:

1. ALL DIMENSIONS AND TOLERANCES CONFORM TO ASME Y14.5M-1994
2. SYMBOL "M" IS THE PIN MATRIX SIZE.
3. CONFORMS TO JEDEC MS-034-AAW-1 (DEPOPULATED)

ug1075_c5_073117

Figure 5-36: Package Dimensions for FFVE1924 (XCZU17EG and XCZU19EG)

Package Marking

Introduction

The package top-markings for the XC and XA Zynq™ UltraScale+™ devices are similar to the examples shown in [Figure 6-1](#) and [Figure 6-2](#). In addition to the markings explained in [Table 6-1](#), refer to the [FAQ: Top Marking Change for 7 Series, UltraScale, and UltraScale+ Products \(XTP424\)](#) and [\(XTP544\)](#).

The package top-markings for the XQ Zynq UltraScale+ devices are as shown in [Figure 6-3](#). On XQ products only the AMD logo and the 2D bar code are marked.

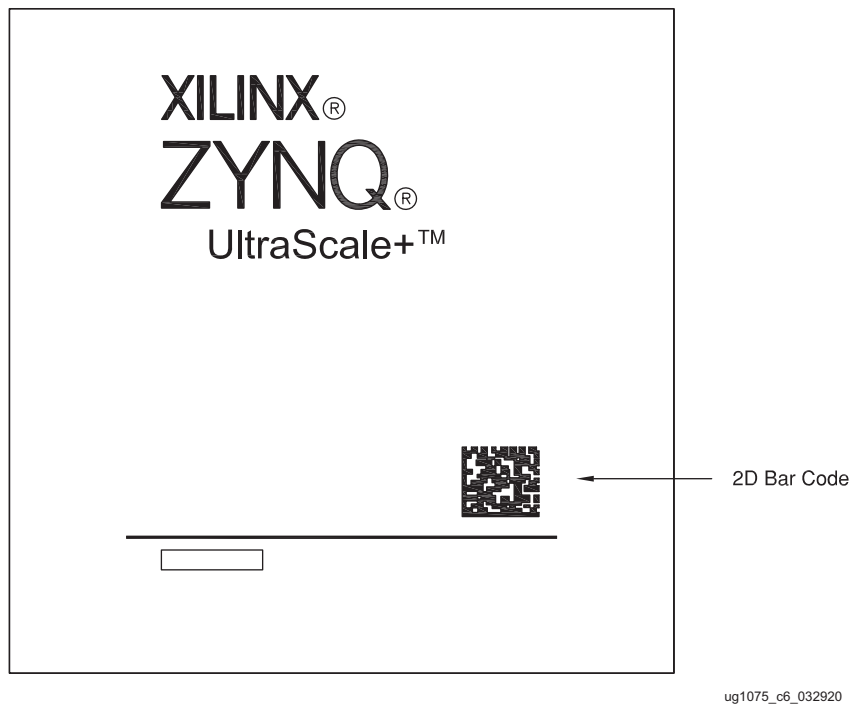

Figure 6-1: XC and XA Zynq UltraScale+ Devices Package Marking

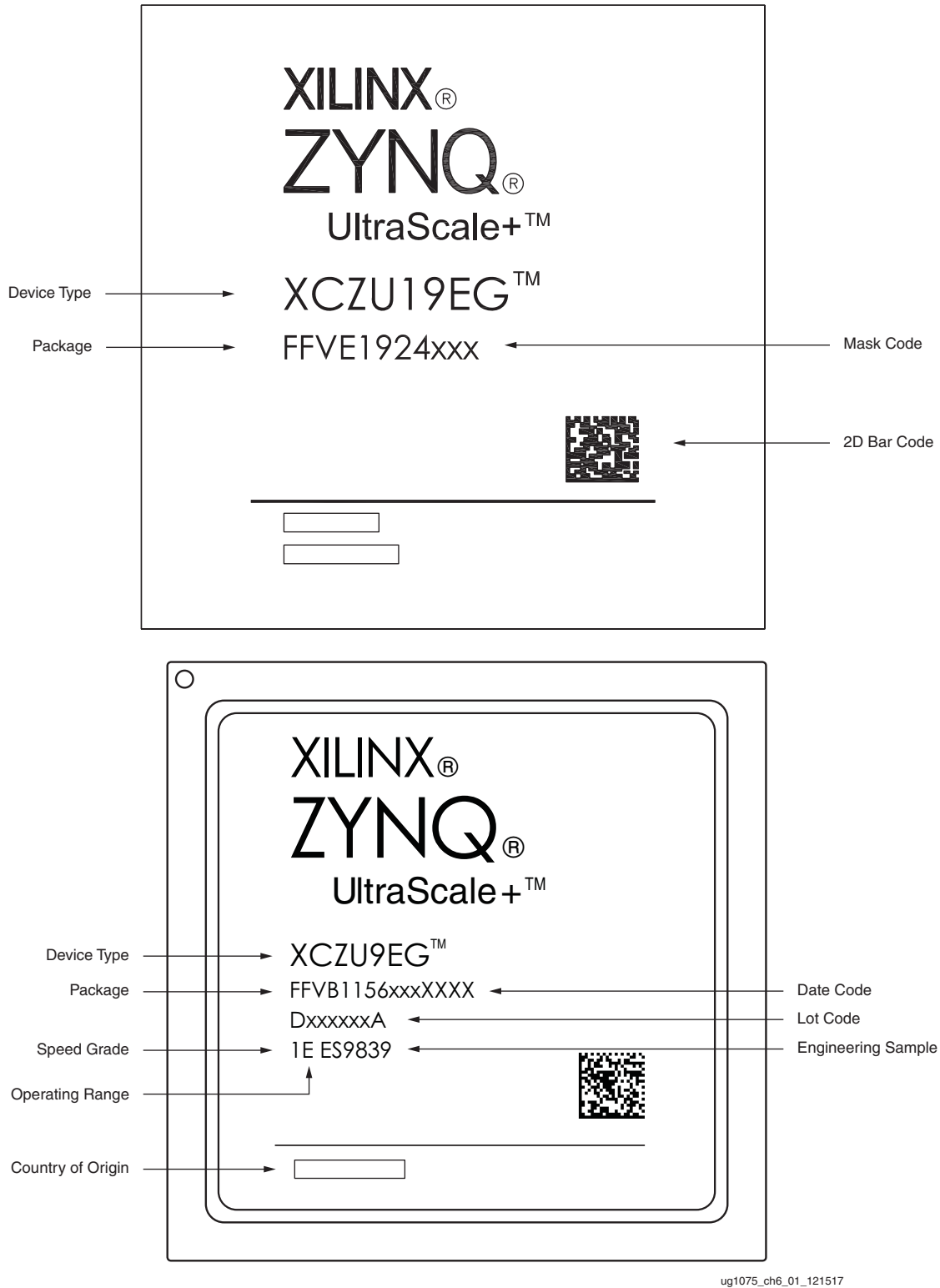

Figure 6-2: XC and XA Zynq UltraScale+ Devices Package Marking

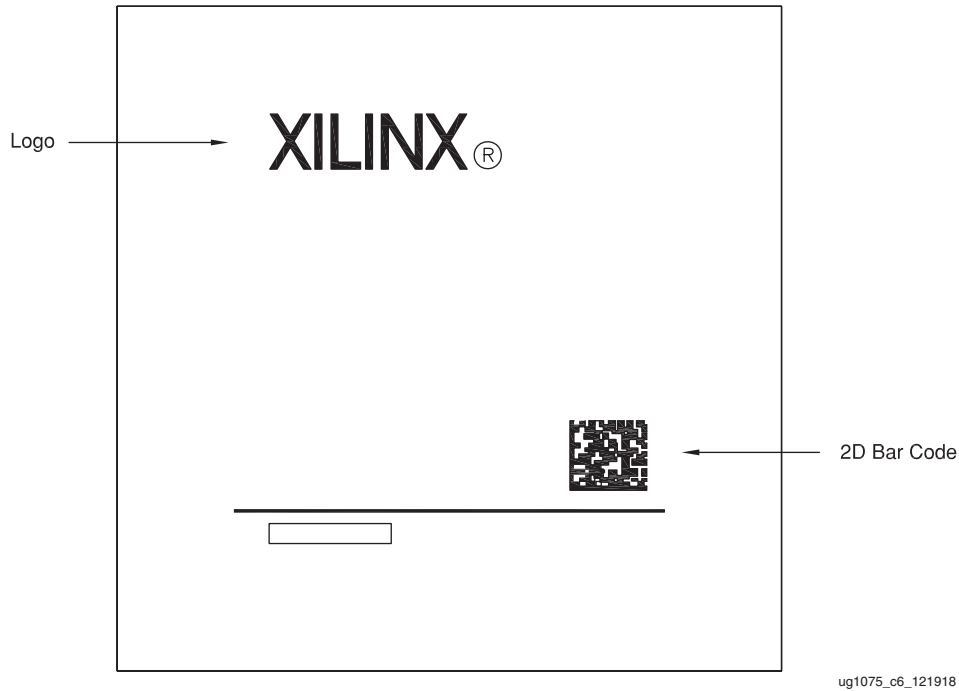

Figure 6-3: XQ Zynq UltraScale+ Devices Package Marking

Table 6-1: XC and XA Device Marking Definition—Example

Item	Definition
AMD Logo	AMD logo, AMD name with trademark, and trademark-registered status.
Family Brand Logo	Device family name with trademark and trademark-registered status. This line is optional and could appear blank.
1st Line	Device name. This line is not marked on some devices. Refer to the bar code for more information.
2nd Line	<p>This line is not marked on some devices. Refer to the bar code for more information.</p> <ul style="list-style-type: none"> Package code: FF 1st digit: F for flip-chip BGA, S for flip-chip BGA with 0.8 mm ball pitch. 2nd digit: F for lidded, B for bare-die. 3rd digit: Pb-free code: V for RoHS 6/6, R or Q for packages with eutectic BGA balls. All Zynq UltraScale+ devices are available with Pb-free RoHS compliant packaging. For more details on Pb-free and RoHS compliant products, see: www.xilinx.com/pbfree. 4th digit: This is the pin out (net list) identifier. 5th–8th digits: These are the physical pin count identifiers: B1156 is shown in the Figure 6-2 example marking drawing. Example: A package code of FFVB1517 and FFVF1517 means they have a different pinout (net list) but the same physical ball count and physical dimensions. Three letter circuit design revision, the location code for the wafer fab, and the geometry code (xxx). When marked, the date code: YYWW. This code is not marked on some devices. Refer to the bar code for more information.

Table 6-1: XC and XA Device Marking Definition—Example (Cont'd)

Item	Definition						
3rd Line	When marked, this line describes ten alphanumeric characters for assembly location, 7-digit lot number, and step information. The last digit is usually an A or an M if a stepping version does not exist. This line is not marked on some devices. Refer to the bar code for more information.						
4th Line	When marked, this line describes the device speed grade (1) and temperature operating range (E). When not marked on the package, the product is considered to operate at the extended (E) temperature range. If a bar code is present on the device, the 4th line might be blank or unmarked. In this case, refer to the bar code for speed grade and temperature range information. For more information on the ordering codes, see the <i>Zynq UltraScale+ MPSoC Overview (DS891)</i> . Other variations for the 4th line: <table border="1" data-bbox="310 636 1482 926"> <tbody> <tr> <td data-bbox="310 636 472 741">L1I</td> <td data-bbox="472 636 1482 741">The L1I indicates a -1LI device. The -1LI speed grade offers reduced maximum power consumption. For more information, see the <i>Zynq UltraScale+ MPSoC Data Sheet: DC and AC Switching Characteristics (DS925)</i>.</td> </tr> <tr> <td data-bbox="310 741 472 825">1E xxxx</td> <td data-bbox="472 741 1482 825">The xxxx indicates a 4-digit SCD device option. An SCD is a special ordering code that is not always marked in the device top mark.</td> </tr> <tr> <td data-bbox="310 825 472 926">1E ES 2I ES L1I ES</td> <td data-bbox="472 825 1482 926">The addition of an ES after the operating temperature range code indicates an engineering sample.</td> </tr> </tbody> </table>	L1I	The L1I indicates a -1LI device. The -1LI speed grade offers reduced maximum power consumption. For more information, see the <i>Zynq UltraScale+ MPSoC Data Sheet: DC and AC Switching Characteristics (DS925)</i> .	1E xxxx	The xxxx indicates a 4-digit SCD device option. An SCD is a special ordering code that is not always marked in the device top mark.	1E ES 2I ES L1I ES	The addition of an ES after the operating temperature range code indicates an engineering sample.
L1I	The L1I indicates a -1LI device. The -1LI speed grade offers reduced maximum power consumption. For more information, see the <i>Zynq UltraScale+ MPSoC Data Sheet: DC and AC Switching Characteristics (DS925)</i> .						
1E xxxx	The xxxx indicates a 4-digit SCD device option. An SCD is a special ordering code that is not always marked in the device top mark.						
1E ES 2I ES L1I ES	The addition of an ES after the operating temperature range code indicates an engineering sample.						
Bar Code	A device-specific bar code is marked on each device. Refer to the <i>FAQ: Top Marking Change for 7 Series, UltraScale, and UltraScale+ Products (XTP424)</i> .						

Packing and Shipping

Introduction

Zynq™ UltraScale+™ devices are packed in trays. Trays are used to pack most of the surface-mount devices since they provide excellent protection from mechanical damage. In addition, they are manufactured using antistatic material to provide limited protection against ESD damage and can withstand a bake temperature of 125°C.

Table 7-1: Standard Device Counts per Tray and Box

Package	Maximum Number of Devices Per Tray	Maximum Number of Units In One Internal Box
SBVA484, SFRA484	84	420
UBVA494	126	630
UBVA530	126	630
SFVA625	60	300
SFVC784, SFVD784, SFVE784, SFRC784	60	300
FBVB900, FFVC900, FFRB900, FFRC900	27	135
FFVB1156, FFRB1156, FFVC1156, FFRC1156 FFVD1156, FFRD1156, FFVE1156, FFRE1156	24	120
FSVE1156	24	72
FFVB1517, FFRB1517, FFVF1517	21	105
FFVG1517, FFRG1517	21	63
FSVG1517, FSRG1517	21	63
FFVC1760, FFRC1760 FFVD1760, FFVF1760, FFSVH1760, FFRF1760	12	60
FSVF1760, FSVH1760, FSRF1760	12	36
FFVE1924	12	36



IMPORTANT: All non-InFO packages are available with eutectic BGA balls. To order these packages, the device type starts with an XQ vs. XC or XA, and the Pb-free signifier in the package name is Q (for example: FFQE1156).

Soldering Guidelines

Soldering Guidelines

To implement and control the production of surface-mount assemblies, the dynamics of the solder reflow process and how each element of the process is related to the end result must be thoroughly understood.



RECOMMENDED: *AMD recommends that customers qualify their custom PCB assembly processes using package samples.*

The primary phases of the reflow process are:

- Melting the particles in the solder paste
- Wetting the surfaces to be joined
- Solidifying the solder into a strong metallurgical bond

The peak reflow temperature of a surface-mount component body should not be more than 250°C maximum (260°C for dry rework only) for Pb-free packages and 220°C for eutectic packages, and is package size dependent. For multiple BGAs in a single board and because of surrounding component differences, AMD recommends checking all BGA sites for varying temperatures.

The infrared reflow (IR) process is strongly dependent on equipment and loading. Components might overheat due to lack of thermal constraints. Unbalanced loading can lead to significant temperature variation on the board. These guidelines are intended to assist users in avoiding damage to the components; the actual profile should be determined by those using these guidelines. For complete information on package moisture / reflow classification and package reflow conditions, refer to the Joint IPC/JEDEC Standard J-STD-020C.



IMPORTANT: *Following the initial placement and reflow process, devices should not be reflowed more than two additional times and should not be removed from the board. Any additional rework beyond that is likely to cause irreparable damage to the device.*

Sn/Pb Reflow Soldering

Figure 8-1 shows typical conditions for solder reflow processing of Sn/Pb soldering using IR/convection. Both IR and convection furnaces are used for BGA assembly. The moisture sensitivity of surface-mount components must be verified prior to surface-mount flow.

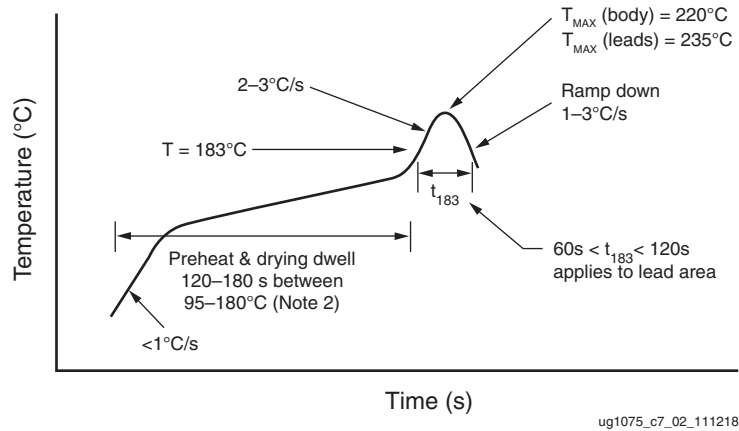

Figure 8-1: Typical Conditions for IR Reflow Soldering of Sn/Pb Solder

Notes for Figure 8-1:

1. Maximum temperature range = 220°C (body). Minimum temperature range before 205°C (leads/balls).
2. Preheat dwell 95–180°C for 120–180 seconds.
3. IR reflow must be performed on dry packages.

Pb-Free Reflow Soldering

AMD uses SnAgCu solder balls for commercial-grade (XC) and automotive-grade (XA) BGA packages. In addition, suitable package materials are qualified for the higher reflow temperatures (250°C maximum, 260°C for dry rework only) required by Pb-free soldering processes.

AMD does not support soldering SnAgCu BGA packages with SnPb solder paste using a Sn/Pb soldering process. Traditional Sn/Pb soldering processes have a peak reflow temperature of 220°C. At this temperature range, the SnAgCu BGA solder balls do not properly melt and wet to the soldering surfaces. As a result, reliability and assembly yields can be compromised.

The optimal profile must take into account the solder paste/flux used, the size of the board, the density of the components on the board, and the mix between large components and smaller, lighter components. Profiles should be established for all new board designs using thermocouples at multiple locations on the component. In addition, if there is a mixture of devices on the board, then the profile should be checked at various locations on the board. Ensure that the minimum reflow temperature is reached to reflow the larger components and at the same time, the temperature does not exceed the threshold temperature that might damage the smaller, heat sensitive components.

[Table 8-1](#) and [Figure 8-2](#) provide guidelines for profiling Pb-free solder reflow of 0.8 mm and 1.0 mm pitch packages. InFo package guidelines are listed in a separate [Table 8-2](#). In general, a gradual, linear ramp into a spike has been shown by various sources to be the optimal reflow profile for Pb-free solders ([Figure 8-2](#)). This profile has been shown to yield better wetting and less thermal shock than conventional ramp-soak-spike profile for the Sn/Pb system. SnAgCu alloy reaches full liquidus temperature at 235°C. When profiling, identify the possible locations of the coldest solder joints and ensure that those solder joints reach a minimum peak temperature of 235°C for at least 10 seconds. Reflowing at high peak temperatures of 260°C and above can damage the heat sensitive components and cause the board to warp. Users should reference the latest IPC/JEDEC J-STD-020 standard for the allowable peak temperature on the component body. The allowable peak temperature on the component body is dependent on the size of the component. Refer to [Table 8-3](#) for peak package reflow body temperature information. In any case, use a reflow profile with the lowest peak temperature possible.

Table 8-1: Pb-Free Reflow Soldering Guidelines

Profile Feature	Convection, IR/Convection
Ramp-up rate	2°C/s maximum. 1°C/s maximum for lidless packages with stiffener ring.
Preheat temperature 150°–200°C	60–120 seconds.
Temperature maintained above 217°C	60–150 seconds (60–90 seconds typical).
Time within 5°C of actual peak temperature	30 seconds maximum.

Table 8-1: Pb-Free Reflow Soldering Guidelines (Cont'd)

Profile Feature	Convection, IR/Convection
Peak temperature (lead/ball)	230°C–245°C typical (depends on solder paste, board size, component mixture).
Peak temperature (body)	240°C–250°C, package body size dependent.
Ramp-down rate	2°C/s maximum.
Time 25°C to peak temperature	3.5 minutes minimum, 5.0 minutes typical, 8 minutes maximum.

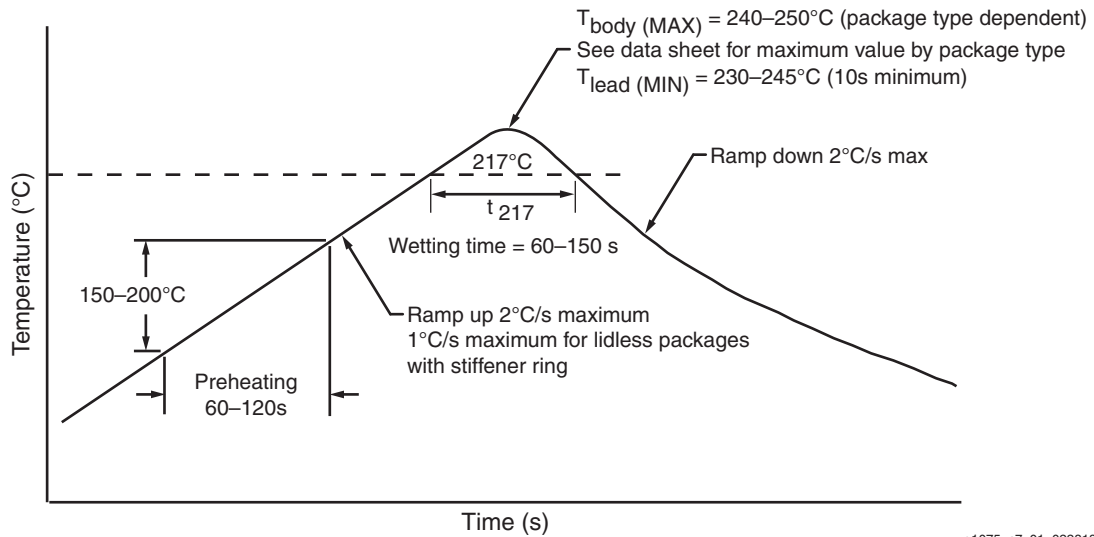

Figure 8-2: Typical Conditions for Pb-Free Reflow Soldering

Table 8-2: InFO Package Reflow Soldering Guidelines

Profile Feature	Convection, IR/Convection
Ramp-up rate	4°C/s maximum
Preheat temperature 150°–190°C	60–100 seconds
Temperature maintained above 217°C	45–75 seconds
Time within 5°C of actual peak temperature	30 seconds maximum
Peak temperature (lead/ball)	230°C–235°C typical (depends on solder paste, board size, component mixture)
Peak temperature (body)	240°C–245°C
Ramp-down rate	2°C/s maximum.
Time 25°C to peak temperature	3.5 minutes minimum, 5.0 minutes typical, 8 minutes maximum.

Peak Package Reflow Temperatures

Table 8-3: Peak Package Reflow Body Temperature (Based on J-STD-020 Standard)

Package	Product Category	Peak Package Reflow Body Temperature	JEDEC Moisture Sensitivity Level (MSL)
SBVA484	XC	Mass reflow: 250°C Dry rework: 260°C	4
SFVA625 SFVC784 SFVD784	XA		3
UBVA494 UBVA530 FBVB900, FFVC900 FFVB1156, FFVC1156 FFVD1156, FFVE1156 FFVB1517, FFVF1517, FSVG1517 FFVC1760, FFVD1760, FFVF1760, FFVH1760 FFVE1924	XC	Mass reflow: 245°C Dry rework: 260°C	4
FBVB900 FFVF1517	XA		3
FSVE1156 FSVG1517 FSVF1760, FSVH1760	All	Mass reflow: 240°C Dry rework: 260°C	4
SFRA484, SFRC784 FFRB900, FFRC900 FFRB1156, FFRC1156 FFRD1156, FFRE1156 FFRB1517, FFRG1517, FSRG1517 FFRC1760, FFRF1760, FSRF1760	XQ ⁽¹⁾	Mass reflow: 220°C Dry rework: 235°C	4

Notes:

1. For devices with the Pb-free signifier in the package name (labeled as Q vs. V) use the temperatures and MSL listed for the XQ product category.

For sophisticated boards with a substantial mix of large and small components, it is critical to minimize the ΔT across the board ($<10^{\circ}\text{C}$) to minimize board warpage and thus, attain higher assembly yields. Minimizing the ΔT is accomplished by using a slower rate in the warm-up and preheating stages. AMD recommends a heating rate of less than 1°C/s during the preheating and soaking stages, in combination with a heating rate of not more than 3°C/s throughout the rest of the profile.

It is also important to minimize the temperature gradient on the component, between top surface and bottom side, especially during the cooling down phase. The key is to optimize cooling while maintaining a minimal temperature differential between the top surface of the package and the solder joint area. The temperature differential between the top surface

of the component and the solder balls should be maintained at less than 7°C during the critical region of the cooling phase of the reflow process. This critical region is in the part of the cooling phase where the balls are not completely solidified to the board yet, usually between the 200°C–217°C range. To efficiently cool the parts, divide the cooling section into multiple zones, with each zone operating at different temperatures.

The optimal profile must take into account the solder paste/flux used, the size of the board, the density of the components on the board, and the mix between large components and smaller, lighter components. Profiles should be established for all new board designs using thermocouples at multiple locations on the component. In addition, if there is a mixture of devices on the board, then the profile should be checked at various locations on the board, as shown in [Figure 8-3](#) and [Figure 8-4](#). Ensure that the minimum reflow temperature is reached to reflow the larger components and at the same time, the temperature does not exceed the threshold temperature that might damage the smaller, heat sensitive components.

- TOP Profile,**
 TC 1 : U17 Edge 1
 TC 2 : U17 Edge 2
 TC 3 : U17 Edge 3
 TC 4 : U17 Edge 4
 TC 5 : U17 Middle 1
 TC 6 : U17 Middle 2
 TC 7 : U17 Body
 TC 8 : Q25
 TC 9 : U25

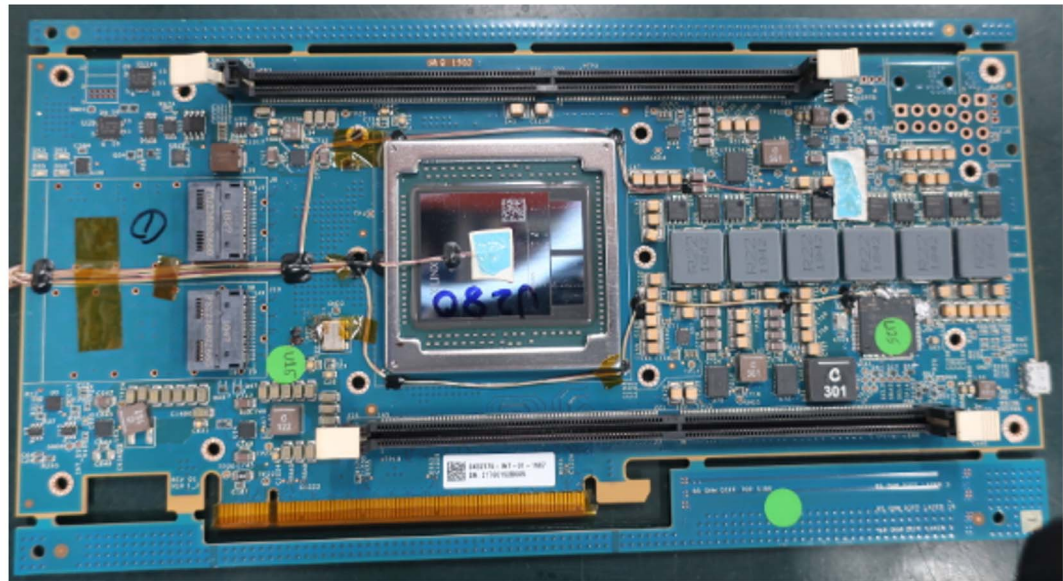

Figure 8-3: Thermocouple Top

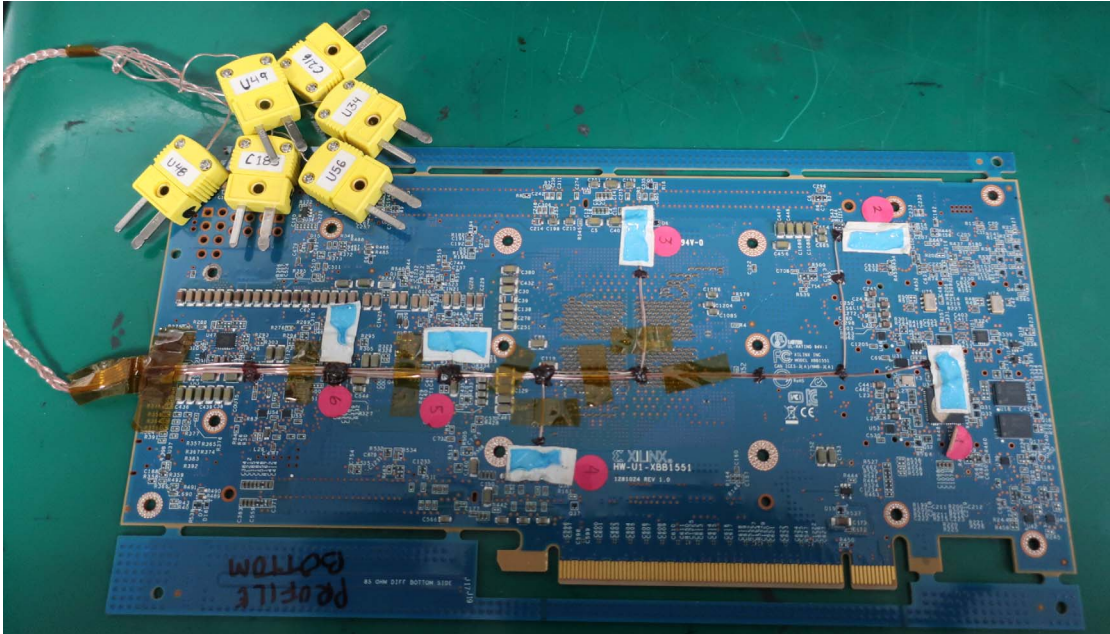

Figure 8-4: Thermocouple Bottom

Post Reflow/Cleaning/Washing

Many PCB assembly subcontractors use a no-clean process in which no post-assembly washing is required. Although a no-clean process is recommended, if cleaning is required, AMD recommends a water-soluble paste and a washer using a deionized-water. Baking after the water wash is recommended to prevent fluid accumulation.

Cleaning solutions or solvents are not recommended because some solutions contain chemicals that can compromise the lid adhesive, thermal compound, or components inside the package.

Strain Gauge Measurement

Strain gauge measurements are recommended to be done at each process step that has the potential to cause excessive board flexing leading to solder joint cracking. Assembly processes where strain gauge measurements are recommended include:

- PCB Router (during PCB loading/unloading into fixture and during the routing process)
- PTH solder assembly during top-catch loading/unloading
- Press fit assembly during press base and tooling loading/unloading and during machine pressing process
- DIMM memory (during PCB loading/unloading and during insertion/removal of DIMM)

- Heat-sink assembly process (during PCB loading/unloading and during entire screw assembly process)
- X-ray fixture (during PCBA loading/unloading)

Strain gauge measurements should be in the range of ± 500 μ strain. Dye and pry analysis is required to confirm if the measured strain causes solder joint cracking. It is recommended to conduct dye and pry analysis for any strain reading greater than 500 μ strain.

To reduce the affects of strain on a device, edge bonding can be used and is recommended for larger packages. See [Edge Bonding and Underfill Guidelines](#) for implementation details.

Solder Paste

Solder paste consists of solder alloy and a flux system. A typical solder paste composition by volume is split between about 50% alloy and 50% flux. The metal load mass (solder alloy powder) is around 90%, with the remaining 10% mass a flux system. The primary purpose of the flux system is to remove the contaminations from the solder joints during the soldering process. The capability of removing contaminations is determined by the activation level of the type of solder paste. The preferred solder paste metal alloy has a lead-free composition (SnAgCu where Ag is 3–4% and Cu is 0.5–1%). A *no-clean* solder paste is preferred to eliminate any risk of improper cleaning that could leave active residue beneath the device and other BTC components. The paste must be suitable for printing the solder stencil aperture dimensions. Type 4 paste is recommended for better paste release performance. When using a solder paste, you must adhere to the handling recommendations of the paste manufacturer.

Component Placement



IMPORTANT: *The following component placement guidelines apply to all package types included in this guide (lidded, lidless, bare-die, etc.).*

AMD device packages must be placed accurately according to their geometry outline. Positioning packages manually via hand mounting is not recommended.

Typical component placement accuracies of ± 50 μ m can be achieved using standard pick and placement machine equipment with vision system. The PCB and the components are optically checked and measured and the components are placed on the PCB in specific programmed positions based on the PCB CAD information. The pick and placement machine vision system detects the fiducials on the PCB immediately prior to mounting the FPGA. Recognition of the packages is performed by the vision system, to ensure correct centering of the FPGA placement on the PCB pad array.

BGA packages with solder balls can self-align during the reflow process because of the solder high surface tension that enables the pulling and centering of the device, and where a slight offset of the placement is still allowed. For guidance, the maximum tolerable offset of device placement is around 30% of the pad diameter on the PCB for typical non-solder mask defined pads. This means that for device packages the solder ball to PCB pad misalignment must be better than 150 μm to assure a robust mounting process. Generally, this is achievable using a wide range of modern pick and placement systems. The following setup conditions are important for the pick and placement systems:

- The pick and placement nozzle type should be sized to the dimensions of the AMD device. The nozzle needs to firmly hold the device package during the pick and placement stage. The appropriate nozzle type for the device package can be chosen from the manual provided by the pick and placement equipment company.
- The ball recognition capabilities of the placement system should be used and package outline centering should be avoided. This eliminates the solder ball to package edge tolerances of the package. Refer to the specific package outline drawing for details.
- To ensure the proper identification of the device package by the vision system, a suitable lighting system and the correct choice of the features of the measuring method are essential. The most suitable settings can be chosen from the manual provided by the pick and placement equipments company.
- To avoid solder bridging or solder smear, ensure the proper placement force of the device package during placement on the PCB. Excessive placement force can lead to excess solder paste and cause solder bridging. However, a slight placement force can lead to insufficient solder paste contact between the device package solder balls and the solder paste, causing solder defects including open solder joints, badly centered packages, or even head-in-pillow (HIP) defects.

Recommended PCB Design Rules for BGA Packages

BGA Packages

AMD provides the diameter of a land pad on the package side. This information is required prior to the start of the board layout so the board pads can be designed to match the component-side land geometry. The typical values of these land pads are described in [Figure 9-1](#) and summarized in [Table 9-1](#) for 1.0 mm pitch packages. For AMD BGA packages, non-solder mask defined (NSMD) pads on the board are suggested to allow a clearance between the land metal (diameter L) and the solder mask opening (diameter M) as shown in [Figure 9-1](#). An example of an NSMD PCB pad solder joint is shown in [Figure 9-2](#). It is recommended to have the board land pad diameter with a 1:1 ratio to the package solder mask defined (SMD) pad for improved board level reliability. The space between the NSMD pad and the solder mask as well as the actual signal trace widths depend on the capability of the PCB vendor. The cost of the PCB is higher when the line width and spaces are smaller.

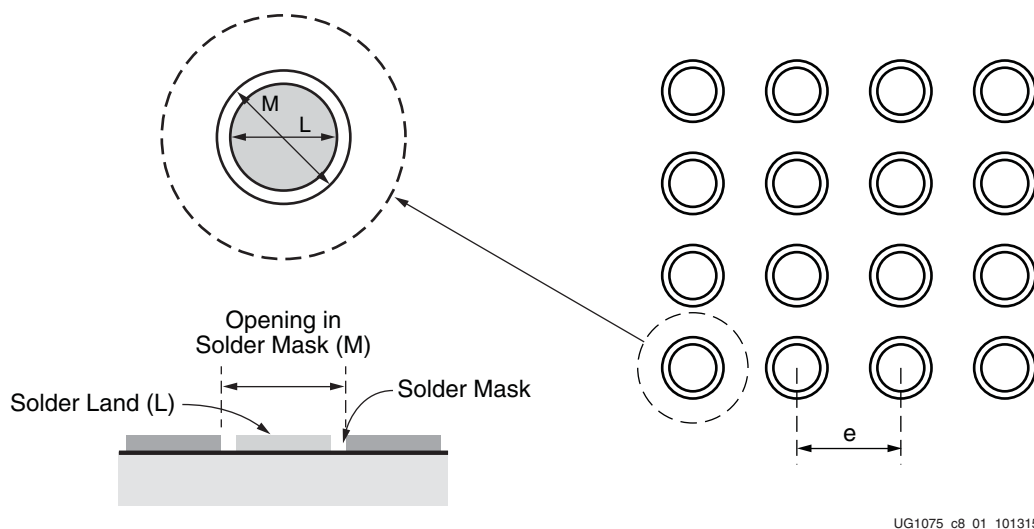
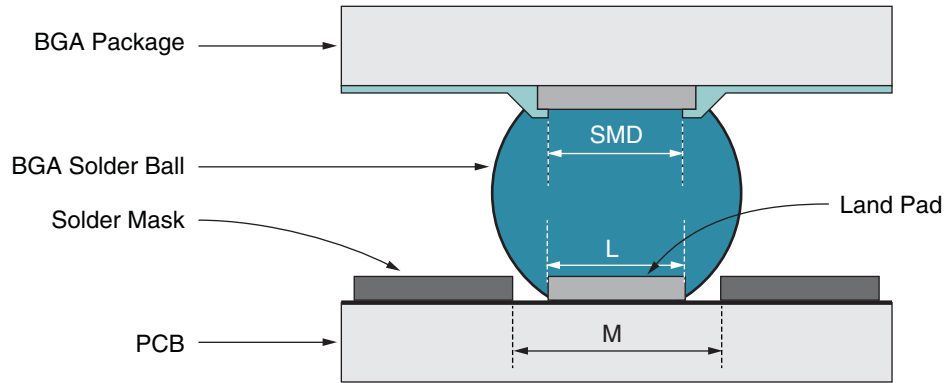

Figure 9-1: Suggested Board Layout of Soldered Pads for BGA Packages



UG1075_c8_02_101315

Figure 9-2: Example of an NSMD PCB Pad Solder Joint

Table 9-1: BGA Package Design Rules

Flip-Chip BGA Packages	1.0 mm Pitch	0.8 mm Pitch	0.5 mm Pitch
Design Rule	Dimensions in mm (mils)		
Package land pad opening (SMD)	0.53 mm (20.9 mils)	0.40 mm (15.7 mils)	0.28 mm (11.0 mils)
Maximum PCB solder land (L) diameter	0.53 mm (20.9 mils)	0.40 mm (15.7 mils)	0.30 mm (12.0 mils)
Opening in PCB solder mask (M) diameter	0.63 mm (24.8 mils)	0.50 mm (19.7 mils)	0.41 mm (16.0 mils)
Solder ball land pitch (e)	1.00 mm (39.4 mils)	0.80 mm (31.5 mils)	0.50 mm (19.7 mils)

Notes:

1. Controlling dimension in mm.

Stencil

Solder paste is applied to PCB metal pads by screen printing. The volume of the printed solder paste is determined by the stencil aperture and the stencil thickness. In most cases, the thickness of a stencil must be matched to the needs of all components on the PCB. Stencil apertures should be a circular shape. To ensure a uniform and high-solder paste transfer to the PCB, laser-cut stencil, made from mostly stainless steel, is typically used. Nickel blank stencils, referring to stencils where the entire foil is laser-cut from a sheet of pure nickel material, can also be used. However, high-quality nano-coated stencils (laser cut from stainless steel) can perform as well as or better than nickel blanks.

Uniform Stencil Aperture Design

- For packages with 1 mm or 0.8 mm ball pitch, a uniform stencil aperture opening of 19.7 mils to 20.0 mils round is recommended.
- For InFO packages with 0.5 mm ball pitch, a uniform stencil with squared aperture openings (rounded corners) of 12 mils and pitch of 19.8 mils, as show in [Figure 9-3](#) is recommended. A stencil thickness of 4 mils is also recommended.

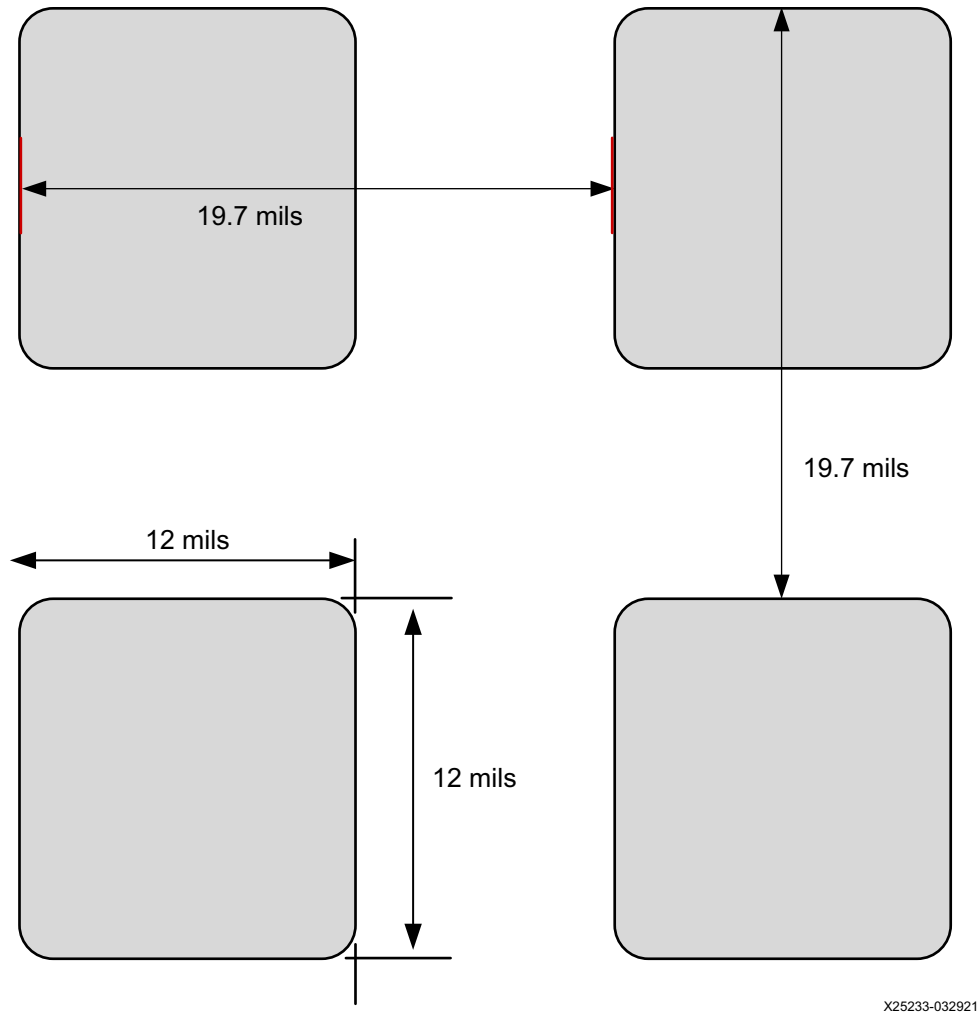

Figure 9-3: Recommended Stencil Design for InFO Packages

Edge Bonding and Underfill Guidelines

Summary

The edge bonding technique uses high-adhesion adhesives dispensed along the periphery of a component, as shown in [Figure 10-1](#). AMD recommends edge bonding for increased mechanical reliability in cases where the device is exposed to extensive temperature cycling or extreme shock and vibration, such as space, defense, and telecommunications applications. Designers are expected to evaluate the need for edge bonding based on the requirements of the specific application implementation.

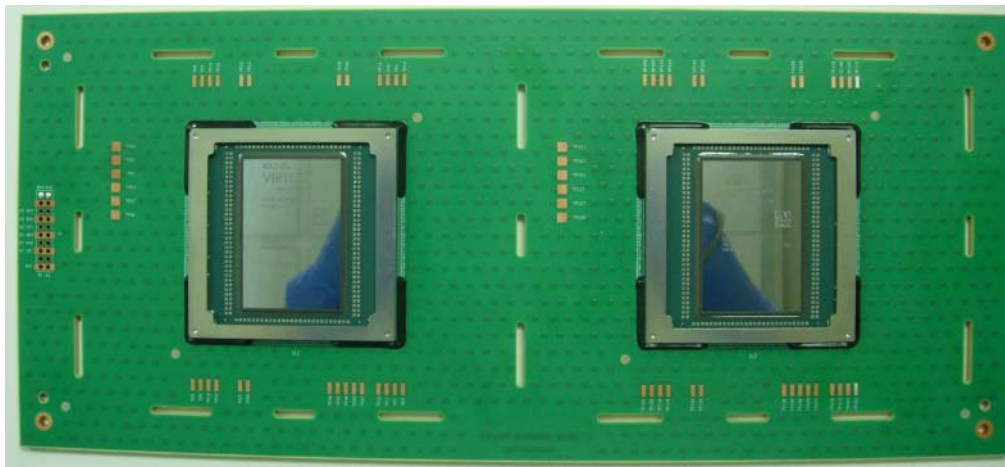

Figure 10-1: Edge Bonded BGA Packages

Edge Bonding Implementation

Edge bonding is the dispensing of an epoxy material around the periphery of the package after board mount. The following guidelines are based on evaluation using the [Zymet UA-2605-B](#) edge bonding material.

This technique allows for component rework and improves the robustness of the mounted component by controlling the expansion and warpage of the board during normal operating conditions.



IMPORTANT: *Following the initial placement and reflow process, devices should not be reflowed more than two additional times and should not be removed from the board. Any additional rework beyond that is likely to cause irreparable damage to the device.*

To place the adhesive while using an in-line soldering robot, AMD recommends the parameters shown in [Table 10-1](#).

Table 10-1: Process Parameters for Edge Bonding

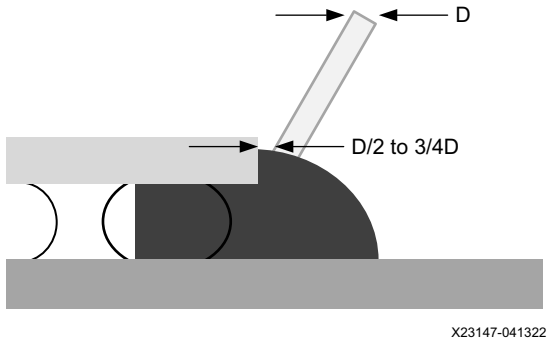
Process Parameter	Range Specification
Needle size	25—15, where needle diameter (D) is 20 gauge (0.91 mm) typical
Needle height	Above the device edge midpoint, or 0 to 1.5 mm below the device top surface (1.0 mm typical)
Needle edge spacing	Half to three quarters of the needle outer diameter (D)  <p style="text-align: right; font-size: small;">X23147-041322</p>
Dispense needle speed	0.1 to 200 mm/second (typical 6 mm/sec)
Valve pressure	10 to 60 psi (typical 14 psi)

The adhesive is dispensed along the perimeter of the assembled component at a width of 3 mm and a height of 50% to 90% the substrate height, leaving a small section at the center of each edge unbonded, as illustrated in [Figure 10-3](#). This is to ensure that there is an outlet for any expansion of the air during processing. AMD recommends centering the opening on each side with a width of 25–30% the length of the package substrate. The exact locations and size of the openings can be varied depending on the design and rework.

To ensure proper mechanical bonding between the package and PCB, the edge bonding feature must penetrate the edge bonding material under the package substrate by 0.8 mm. This requirement is necessary for packages with coplanarity $\leq 200 \mu\text{m}$, and BGA pitch of 1 mm or 0.92 mm, to pass physical qualification tests such as thermal cycle, power cycle, and shock and vibration requirements. It is necessary for special applications such as telecom, industrial, and data center applications.



IMPORTANT: Some package devices have an overhang substrate that can result in the first row of the BGA not being covered by edge-bonding material. In other scenarios, the first BGA row could cover up to 90% of the BGA. See the following scenarios.

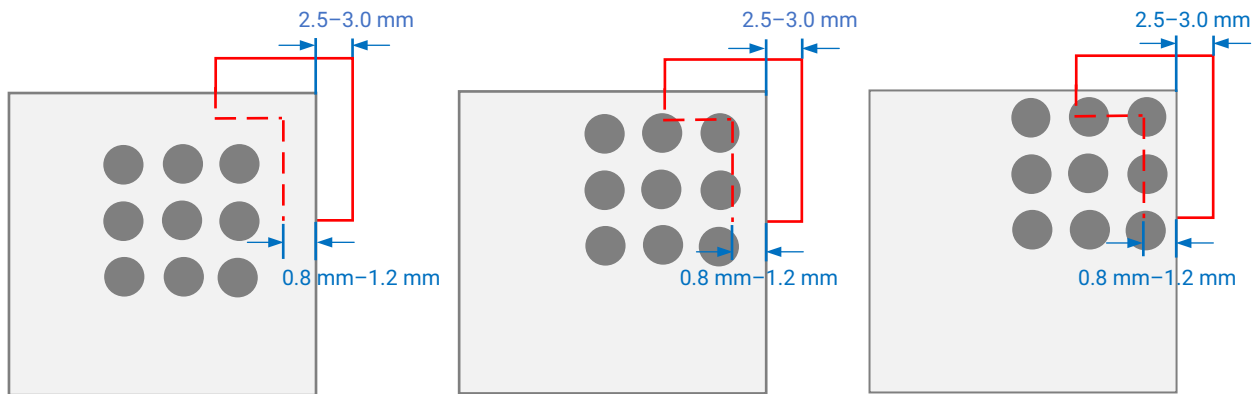

Scenario 1
Space between edge of substrate and first row of solder balls $> 1.2 \text{ mm}$.
Ball diameter 0.64 mm.
The edge bonding penetration under the package must be between 0.8 mm to 1.2 mm.

Scenario 2
Space between edge of substrate and first row of solder balls $\leq 1.2 \text{ mm}$ and $> 0.8 \text{ mm}$ (can be partially covered).
Ball diameter 0.64 mm.
The edge bonding penetration under the package must be between 0.8 mm to 1.2 mm.

Scenario 3
Space between edge of substrate and first row of solder balls $\leq 0.8 \text{ mm}$ (first row of solder balls are covered up to 90% by edge bond material).
Ball diameter 0.64 mm.
The edge bonding penetration under the package must be between 0.8 mm to 1.2 mm.

X27880-092424

Figure 10-2: Edge Bonding Scenarios

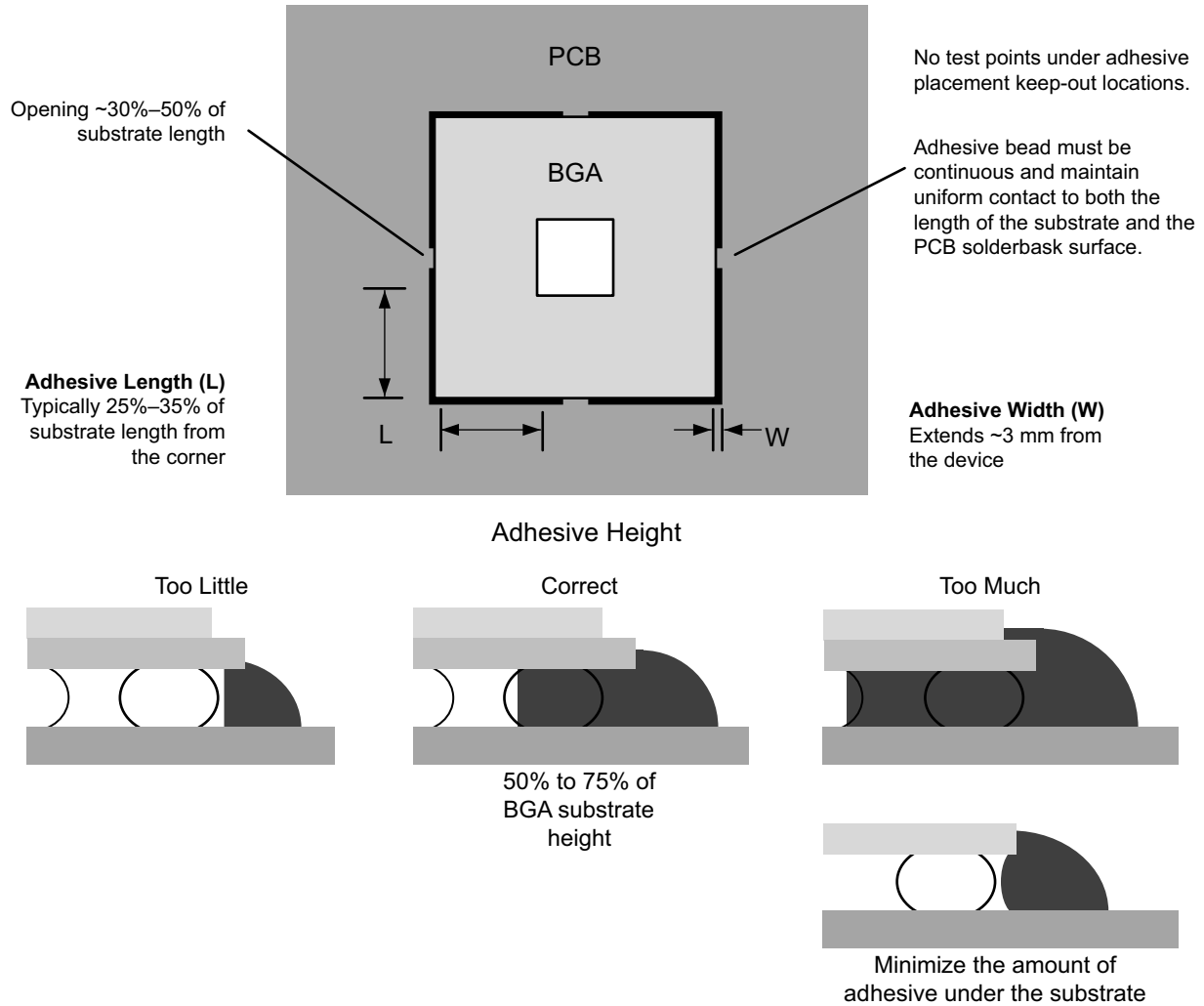

X23146-041322

Figure 10-3: Edge Bonding Adhesive Placement Parameters



RECOMMENDED: Curing condition of the [Zymet UA-2605-B](#) edge-bonding material is 140°C for 5 minutes.

Component Clearance Surrounding Edge Bond

An adjacent component clearance surrounding the AMD device is necessary to have the 30° to 45° angle required by the for the edge bond dispenser to dispense the edge bond adhesive material. The surrounding component height and distance from the device is validated based on each unique product design layout.

Edge Bond Removal

Edge bond material can be removed by heating to 170–180°C, and scraping using a stiff probe made of stable organic material such as a non-resinous wood or Teflon. Use a hot air blower on the edge bond area and slowly remove the edge bond adhesive from side to side. Do not use force to remove the edge bond adhesive. Excess adhesive on the PCB can be removed using a chisel-tip soldering iron, with sufficient precautions to limit damage to the PCB surface.

Underfill Guidelines

To meet the mechanical reliability standards for most applications, high-adhesion underfill between the package and the PCB is required for all InFO packages (e.g., UBVA530). This allows for improved robustness of the mounted component by controlling the expansion and warpage of the package and board during normal operating conditions. The following sections detail the recommended implementation of underfill on a pre-mounted InFO package.

Underfill Implementation

The recommended underfill process comprises of dispensing an epoxy material along one side of the package after board mount and allowing flow by way of capillary action through the BGA field. Based on the evaluation, the recommended dispensing pattern and process are detailed in the following tables.

Note: Underfill recommendations are based on evaluation with AMD devices using LOCTITE® ECCOBOND UF 3812 epoxy underfill.

Table 10-2: Underfill Pattern

Dispensing Pattern	Multiple-Pass Variable Length
Dispensing length	75% & 100% of package body length
Dispensing speed	15 mm/sec
Number of passes	4
Pass number and dispense length	Pass 1 & 2: 75% of package body length Pass 3 & 4: 100% of package body length
Interval between each pass	Between pass 1 & 2: 4 seconds Between Pass 2 & 3: 6 seconds Between Pass 3 & 4: 9 seconds

Table 10-3: Underfill Process Parameters

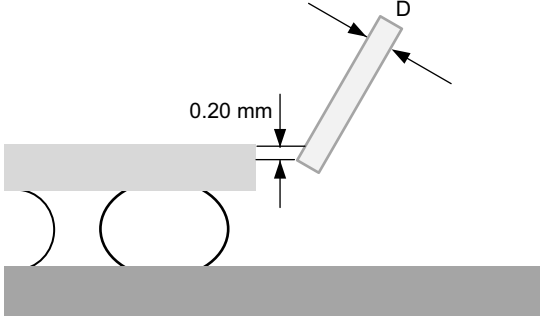
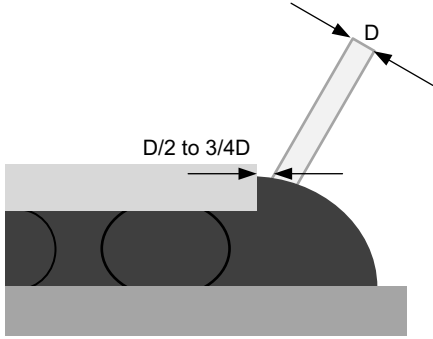
Process Parameter	Range Specification
Needle size	Range: 25—20 gauge Recommended: 23 gauge. Needle diameter (D) is 0.64mm
Needle height	Range: Above the device edge midpoint, or 0 to 0.2 mm below the device top surface Recommended: 0.2 mm from the top surface of the device  <p style="text-align: right; font-size: small;">X27743-020823</p>
Needle edge spacing	Range: Half to three quarters of the needle outer diameter (D) Recommendation: $D/2$, half of the needle diameter, approximately 0.32 mm  <p style="text-align: right; font-size: small;">X27744-020823</p>
Dispense needle speed	Range: 0.1 to 200 mm/sec Recommendation: 15 mm/sec
Valve pressure	Range: 10 to 60 psi Recommendation: 14.5 psi

The following image is an example of underfill adhesive placement on a typical InFo package.

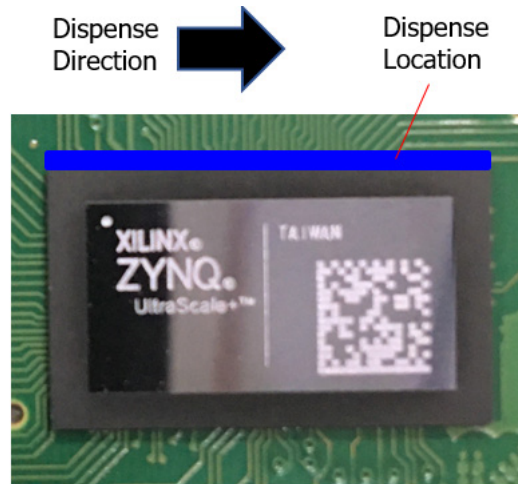

X27745-020823

Figure 10-4: Underfill Dispensing Location



RECOMMENDED: Curing time and temperature varies by the type of underfill used. Based on evaluation, oven curing temperature setting conditions are typically 155°C for 12 minutes. In this case, the temperature profile for the underfill material should be 150°C for 7 minutes.

Underfill Keep-out Requirements

To ensure that underfill bleed-out does not impact surrounding components, the keep-out requirements shown in the following table must be considered.

Table 10-4: Underfill Keep-out Requirements

Keep-Out Between Components	Minimum Spacing (mm)
Underfilled BGA to underfilled BGA	5.0
Underfilled BGA to non-underfilled BGA	2.5
Underfilled BGA to passive components	2.5

Underfill Rework

The following steps detail the underfill rework process based on evaluation on a typical InFO package. This process is only possible with re-workable epoxy underfill and varies depending on the underfill type and manufacturer.

Required Instrumentation:

- Equipment: SRT machine, SRT nozzle, and pallet
- Materials: Tacky flux
- Hand tools: Tweezers, steel probe with round pointed tip, solder wick, and cotton swab



X27746-020823

Figure 10-5: Underfill Rework Tools

Step 1: Pre-bake

Boards are required to bake at least 4 hours at 125°C to avoid any moisture induced failure during the rework process.

Step 2: SRT Machine Program Creation

An SRT machine is highly recommended for the underfill rework process. An SRT machine allows you to control temperature and time at multiple stages. The underfill rework program for an SRT machine needs to be created with three stages, shown in the following table. The bottom heater temperature should be set at 150°C for all stages to allow efficient ramp time, control board warping, and minimize unnecessary heating of neighboring components.

Table 10-5: Underfill Rework SRT Machine Program

Stage	Nozzle Temperature	Time (seconds)	Description
Stage 1	200°C	100	Pre-heating and underfill fillet removal engulfing the component
Stage 2	220°C to 230°C	100	Component Removal
Stage 3	200°C to 225°C	150	Rework site cleaning—scrape underfill residue

Step 3: Machine and Board Setup

- a. Select and load the program. Measure the thermal profile prior to underfill rework to validate the program is within specifications.
- b. Use the pallet to clamp and secure the board position on the SRT machine. Sufficient support is needed to prevent the board from flexing or warping during rework.
- c. Assemble the nozzle to the SRT machine top heater. Use a nozzle that is slightly larger (+1mm) than the component on all sides. This is to allow even heat and air flow to the component and to control excess heat exposure to nearby components. Thermal shielding can also be applied to nearby component to minimize excess heat.
- d. To begin the pre-heating process, lower the SRT nozzle to the top of the rework surface (2 mm to 3 mm above), as shown in the following figure.

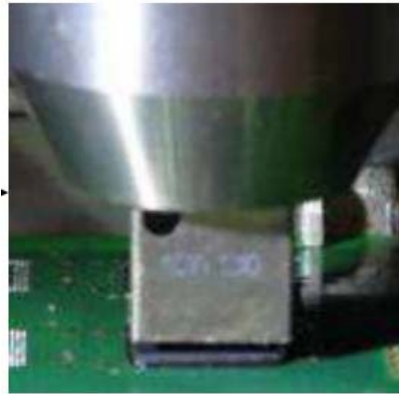

X27751-020923

Figure 10-6: SRT Nozzle Lowered 2 mm to 3 mm from Component Top Surface

Step 4 (Stage 1): Pre-Heating

During pre-heating, allow the component to reach 200°C. Use non-abrasive tools (a wooden probe) to scrape off the underfill fillet around the component. If using a steel probe with a round pointed tip, ensure that the tip is directed away from the component side wall to prevent any damage to the solder mask.



Figure 10-7: Removing Underfill Using Steel Probe

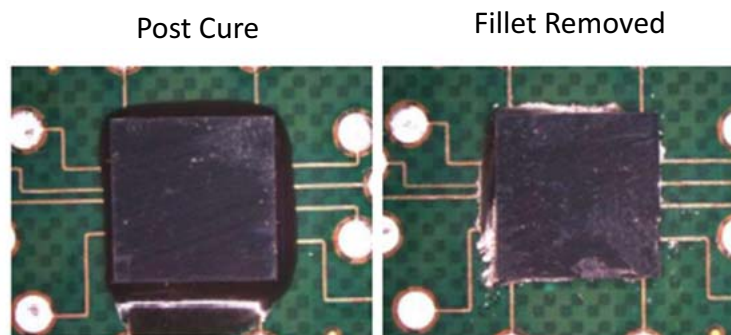

X27753-020923

Figure 10-8: Removing the Underfill Fillet (Before and After)

Step 5 (Stage 2): Component Removal

After underfill fillet removal is complete, ramp up the temperature above 220°C prior to component removal. Considering that the solder paste (SAC305) melting point is from 217°C to 220°C, ensure the rework component achieves an even temperature of 220°C or above to avoid potential defects such as pad lifting.

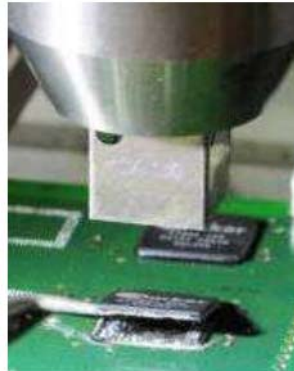
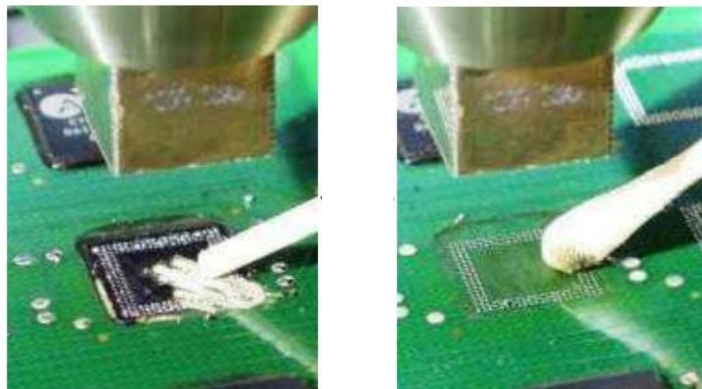

Figure 10-9: Component Removal

Step 6 (Stage 3): Rework Site Cleaning

The final stage is rework site cleaning. After component removal, use a non-abrasive tool (wooden probe) to scrape off the underfill residue. Use a flux saturated cotton swab to pick up and clean the remaining underfill residue.



X27754-020923

Figure 10-10: Scrape Away Underfill Residue and Clean with a Flux Saturated Cotton Swab

Conformal Coating

AMD does not have information regarding the reliability of flip-chip BGA packages on a board after exposure to any specific conformal coating process. Therefore, any process using conformal coating should be qualified for the specific use case to cover the materials and process steps.

Ruggedized XQ packages are designed to support conformal coating, with vented lids that ensure proper cleaning can occur after the etching process and prior to conformal coating.



RECOMMENDED: *When a conformal coating is required, Parylene-based material should be used to avoid potential risk of weakening the lid or stiffener ring adhesive used in AMD packages.*

Thermal Specifications

Introduction

Zynq™ UltraScale+™ devices are offered exclusively in thermally efficient flip-chip BGA packages. These flip-chip packages range in pin-count from the smaller 19 x 19 mm SBVA484 to the 45 x 45 mm FFVE1924. This suite of packages is used to address the various power requirements of the Zynq UltraScale+ devices. Zynq UltraScale+ devices are implemented in the 16 nm process technology.

Unlike features in an ASIC, the combination of Zynq UltraScale+ device features used in a user application is not known to the component supplier. Therefore, it remains a challenge for AMD to predict the power requirements of a given Zynq UltraScale+ device when it leaves the factory. Accurate estimates are obtained when the board design takes shape. For this purpose, AMD offers and supports a suite of integrated device power analysis tools to help users quickly and accurately estimate their design power requirements. Zynq UltraScale+ devices are supported similarly to previous products. The uncertainty of design power requirements makes it difficult to apply canned thermal solutions to fit all users. Therefore, AMD devices do not come with preset thermal solutions. Your design's operating conditions dictate the appropriate solution.

Thermal Resistance Data

Table 11-1 shows the thermal resistance data for Zynq UltraScale+ devices (grouped in the packages offered). The data includes junction-to-ambient in still air, junction-to-case, and junction-to-board data based on standard JEDEC four-layer measurements.



IMPORTANT: The data in Table 11-1 is for device/package comparison purposes only. Attempts to recreate this data are only valid using the transient 2-phase measurement techniques outlined in JESD51-14. Do not use these values for thermal simulations. Use the [Package Thermal Models](#).



TIP: The thermal data query for all available devices by package is available on the AMD website: www.xilinx.com/cgi-bin/thermal/thermal.pl.



IMPORTANT: All non-InFO packages are available with eutectic BGA balls. To order these packages, the device type starts with an XQ vs. XC or XA, and the Pb-free signifier in the package name is Q (for example: FFQE1156). Refer to the Pb-free version of these packages for their thermal resistance data and thermal models.

Table 11-1: Thermal Resistance Data

Package	Package Body Size	Devices	$\theta_{JB}^{(1)}$ (°C/W)	$\theta_{JC}^{(1)}$ (°C/W)	$\theta_{JA}^{(1)}$ (°C/W)	θ_{JA} -Effective (°C/W) ⁽²⁾		
						@250 LFM	@500 LFM	@750 LFM
SBVA484	19 x 19	XCZU1	3.35	0.09	16.9	12.5	10.5	9.7
		XCZU2	2.46	0.06	14.9	11.5	9.6	8.9
		XCZU3	2.46	0.06	14.9	11.5	9.6	8.9
		XAZU1EG	3.35	0.09	16.9	12.5	10.5	9.7
		XAZU2EG	2.46	0.06	14.9	11.5	9.6	8.9
		XAZU3EG	2.46	0.06	14.9	11.5	9.6	8.9
SFRA484	19 x 19	XQZU3EG	2.70	0.43	15.3	11.7	9.8	9.1
UBVA494	15 x 9.5	XCZU1	2.28	0.03	22.4	19.7	16.5	15.0
UBVA530	16 x 9.5	XCZU2	2.28	0.03	22.4	19.7	16.5	15.0
		XCZU3	2.28	0.03	22.4	19.7	16.5	15.0
SFVA625	21 x 21	XCZU1	2.58	0.52	13.8	10.2	8.6	8.0
		XCZU2	2.22	0.38	13.2	9.9	8.3	7.8
		XCZU3	2.22	0.38	13.2	9.9	8.3	7.8
		XAZU1EG	2.58	0.52	13.8	10.2	8.6	8.0
		XAZU2EG	2.22	0.38	13.2	9.9	8.3	7.8
		XAZU3EG	2.22	0.38	13.2	9.9	8.3	7.8

Table 11-1: Thermal Resistance Data (Cont'd)

Package	Package Body Size	Devices	$\theta_{JB}^{(1)}$ (°C/W)	$\theta_{JC}^{(1)}$ (°C/W)	$\theta_{JA}^{(1)}$ (°C/W)	$\theta_{JA\text{-Effective}}^{(2)}$ (°C/W)		
						@250 LFM	@500 LFM	@750 LFM
SFVC784	23 x 23	XCZU1	2.50	0.49	12.5	9.1	7.6	7.1
		XCZU2	2.67	0.50	12.8	9.2	7.8	7.2
		XCZU3	2.67	0.50	12.8	9.2	7.8	7.2
		XCZU4	2.28	0.27	12.2	8.9	7.4	7.0
		XCZU5	2.28	0.27	12.2	8.9	7.4	7.0
		XAZU1EG	2.50	0.49	12.5	9.1	7.6	7.1
		XAZU2EG	2.67	0.50	12.8	9.2	7.8	7.2
		XAZU3EG	2.67	0.50	12.8	9.2	7.8	7.2
		XAZU4EV	2.28	0.27	12.2	8.9	7.4	7.0
		XAZU5EV	2.28	0.27	12.2	8.9	7.4	7.0
SFVE784	23 x 23	XCZU4	2.28	0.27	12.2	8.9	7.4	7.0
		XCZU5	2.28	0.27	12.2	8.9	7.4	7.0
SFRC784	23 x 23	XQZU3EG	2.44	0.42	12.4	9.0	7.6	7.1
		XQZU5EV	2.26	0.27	12.1	8.9	7.4	7.0
FBVB900	31 x 31	XCZU4	2.62	0.04	9.6	6.3	5.3	5.0
		XCZU5	2.62	0.04	9.6	6.3	5.3	5.0
		XCZU7	2.32	0.03	9.2	6.1	5.1	4.8
		XAZU7	2.32	0.03	9.2	6.1	5.1	4.8
FFRB900	31 x 31	XQZU5EV	2.26	0.27	9.1	6.1	5.1	4.8
		XQZU7EV	2.14	0.19	8.9	6.0	5.0	4.8
FFVC900	31 x 31	XCZU6	2.33	0.25	9.2	6.1	5.1	4.9
		XCZU9	2.33	0.25	9.2	6.1	5.1	4.9
		XCZU15	2.25	0.18	9.1	6.1	5.1	4.8
FFRC900	31 x 31	XQZU9EG	2.10	0.18	8.9	6.0	5.0	4.7
		XQZU15EG	2.07	0.17	8.9	6.0	5.0	4.7
FFVB1156	35 x 35	XCZU6	2.40	0.20	8.3	5.3	4.5	4.2
		XCZU9	2.40	0.20	8.3	5.3	4.5	4.2
		XCZU15	2.09	0.23	7.9	5.1	4.3	4.1
FFRB1156	35 x 35	XQZU9EG	2.09	0.18	7.9	5.1	4.3	4.1
		XQZU15EG	2.06	0.17	7.9	5.1	4.3	4.1
FFVC1156	35 x 35	XCZU7	2.39	0.21	8.3	5.3	4.5	4.2
		XCZU11	2.20	0.16	8.0	5.2	4.3	4.1
FFRC1156	35 x 35	XQZU7EV	2.12	0.19	7.9	5.2	4.3	4.1
		XQZU11EG	2.01	0.15	7.8	5.1	4.3	4.1

Table 11-1: Thermal Resistance Data (Cont'd)

Package	Package Body Size	Devices	$\theta_{JB}^{(1)}$ (°C/W)	$\theta_{JC}^{(1)}$ (°C/W)	$\theta_{JA}^{(1)}$ (°C/W)	$\theta_{JA-Effective}^{(2)}$ (°C/W)		
						@250 LFM	@500 LFM	@750 LFM
FFVD1156	35 x 35	XCZU21DR	1.94	0.16	7.8	5.1	4.2	4.0
FFRD1156	35 x 35	XQZU21DR	1.94	0.16	7.8	5.1	4.2	4.0
FFVE1156	35 x 35	XCZU25DR	1.94	0.16	7.8	5.1	4.2	4.0
		XCZU27DR	1.94	0.16	7.8	5.1	4.2	4.0
		XCZU28DR	1.94	0.16	7.8	5.1	4.2	4.0
		XCZU42DR	1.94	0.16	7.8	5.1	4.2	4.0
		XCZU43DR	1.94	0.16	7.8	5.1	4.2	4.0
		XCZU47DR	1.94	0.16	7.8	5.1	4.2	4.0
		XCZU48DR	1.94	0.16	7.8	5.1	4.2	4.0
		XCZU63DR	1.94	0.16	7.8	5.1	4.2	4.0
		XCZU64DR	1.94	0.16	7.8	5.1	4.2	4.0
		XCZU65DR	1.94	0.16	7.8	5.1	4.2	4.0
FFRE1156	35 x 35	XQZU28DR	1.93	0.11	7.7	5.1	4.2	4.0
		XQZU48DR	1.94	0.16	7.8	5.1	4.2	4.0
FSVE1156	35 x 35	XCZU25DR	2.40	0.02	8.3	5.3	4.4	4.2
		XCZU27DR	2.40	0.02	8.3	5.3	4.4	4.2
		XCZU28DR	2.40	0.02	8.3	5.3	4.4	4.2
		XCZU42DR	2.40	0.02	8.3	5.3	4.4	4.2
		XCZU43DR	2.40	0.02	8.3	5.3	4.4	4.2
		XCZU47DR	2.40	0.02	8.3	5.3	4.4	4.2
		XCZU48DR	2.40	0.02	8.3	5.3	4.4	4.2
		XCZU63DR	2.40	0.02	8.3	5.3	4.4	4.2
		XCZU64DR	2.40	0.02	8.3	5.3	4.4	4.2
		XCZU65DR	2.40	0.02	8.3	5.3	4.4	4.2
FFVB1517	40 x 40	XCZU11	2.22	0.16	7.1	4.4	3.7	3.5
		XCZU17	2.17	0.11	7.0	4.4	3.7	3.5
		XCZU19	2.17	0.11	7.0	4.4	3.7	3.5
FFRB1517	40 x 40	XQZU19EG	1.90	0.11	6.8	4.3	3.5	3.4
FFVF1517	40 x 40	XCZU7	2.38	0.21	7.3	4.5	3.8	3.6
		XCZU11	2.22	0.16	7.1	4.4	3.7	3.5
		XAZU11	2.22	0.16	7.1	4.4	3.7	3.5

Table 11-1: Thermal Resistance Data (Cont'd)

Package	Package Body Size	Devices	$\theta_{JB}^{(1)}$ (°C/W)	$\theta_{JC}^{(1)}$ (°C/W)	$\theta_{JA}^{(1)}$ (°C/W)	$\theta_{JA-Effective}$ (°C/W) ⁽²⁾		
						@250 LFM	@500 LFM	@750 LFM
FFVG1517	40 x 40	XCZU25DR	1.93	0.16	6.8	4.3	3.6	3.4
		XCZU27DR	1.93	0.16	6.8	4.3	3.6	3.4
		XCZU28DR	1.93	0.16	6.8	4.3	3.6	3.4
		XCZU43DR	1.93	0.16	6.8	4.3	3.6	3.4
		XCZU47DR	1.93	0.16	6.8	4.3	3.6	3.4
		XCZU48DR	1.93	0.16	6.8	4.3	3.6	3.4
FFRG1517	40 x 40	XQZU28DR	1.93	0.16	6.8	4.3	3.6	3.4
FVRG1517	40 x 40	XQZU48DR	2.43	0.02	7.3	4.5	3.8	3.6
FVVG1517	40 x 40	XCZU25DR	2.43	0.02	7.3	4.5	3.8	3.6
		XCZU27DR	2.43	0.02	7.3	4.5	3.8	3.6
		XCZU28DR	2.43	0.02	7.3	4.5	3.8	3.6
		XCZU43DR	2.43	0.02	7.3	4.5	3.8	3.6
		XCZU47DR	2.43	0.02	7.3	4.5	3.8	3.6
		XCZU48DR	2.43	0.02	7.3	4.5	3.8	3.6
FFVC1760	42.5 x 42.5	XCZU11	1.96	0.14	6.4	4.0	3.3	3.2
		XCZU17	1.77	0.10	6.3	3.9	3.2	3.1
		XCZU19	1.77	0.10	6.3	3.9	3.2	3.1
FFRC1760	42.5 x 42.5	XQZU11EG	1.96	0.14	6.4	4.0	3.3	3.2
		XQZU19EG	1.77	0.10	6.3	3.9	3.2	3.1
FFVD1760	42.5 x 42.5	XCZU17	1.77	0.10	6.3	3.9	3.2	3.1
		XCZU19	1.77	0.10	6.3	3.9	3.2	3.1
FFVF1760	42.5 x 42.5	XCZU29DR	2.04	0.17	6.5	4.0	3.3	3.2
		XCZU39DR	2.04	0.17	6.5	4.0	3.3	3.2
		XCZU49DR	2.04	0.17	6.5	4.0	3.3	3.2
FFVH1760	42.5 x 42.5	XCZU46DR	2.04	0.17	6.5	4.0	3.3	3.2
FFRF1760	42.5 x 42.5	XQZU29DR	2.04	0.17	6.5	4.0	3.3	3.2
FVRF1760	42.5 x 42.5	XQZU49DR	2.47	0.02	7.0	4.3	3.5	3.6
FVVF1760	42.5 x 42.5	XCZU29DR	2.47	0.02	7.0	4.3	3.5	3.6
		XCZU39DR	2.47	0.02	7.0	4.3	3.5	3.6
		XCZU49DR	2.47	0.02	7.0	4.3	3.5	3.6
FVH1760	42.5 x 42.5	XCZU46DR	2.47	0.02	7.0	4.3	3.5	3.6

Table 11-1: Thermal Resistance Data (Cont'd)

Package	Package Body Size	Devices	$\theta_{JB}^{(1)}$ (°C/W)	$\theta_{JC}^{(1)}$ (°C/W)	$\theta_{JA}^{(1)}$ (°C/W)	$\theta_{JA-Effective}^{(2)}$ (°C/W)		
						@250 LFM	@500 LFM	@750 LFM
FFVE1924	45 x 45	XCZU17	1.77	0.10	5.9	3.6	3.0	2.9
		XCZU19	1.77	0.10	5.9	3.6	3.0	2.9

Notes:

1. This data is for device/package comparison purposes only. Attempts to recreate this data are only valid using the transient 2-phase measurement techniques outlined in JESD51-14. Do not use these values for thermal simulations. Use the [Package Thermal Models](#).
2. All $\theta_{JA-Effective}$ values assume no heat sink and include thermal dissipation through a standard JEDEC four-layer board. The power estimation tools (Vivado™ Power Analysis, and XPE), which require detailed board dimensions and layer counts, are useful for deriving more precise $\theta_{JA-Effective}$ values.

Support for Thermal Models

Table 11-1 provides the traditional thermal resistance data for Zynq UltraScale+ devices. These resistances are measured using a prescribed JEDEC standard that might not necessarily reflect your actual board conditions and environment. The quoted θ_{JA} and θ_{JC} numbers are environmentally dependent, and JEDEC has traditionally recommended that these be used with that awareness. For more accurate junction temperature prediction, these might not be enough, and a system-level thermal simulation might be required.

Though AMD continues to support these figures of merit data, for Zynq UltraScale+ devices, boundary conditions independent thermal resistor network (Delphi) models are offered for all Zynq UltraScale+ devices. These compact models seek to capture the thermal behavior of the packages more accurately at predetermined critical points (junction, case, top, leads, and so on) with the reduced set of nodes as illustrated in Figure 11-1.

Unlike a full 3D model, these are computationally efficient and work well in an integrated system simulation environment. Delphi models are available for download on the AMD website (under the [Device Model](#) tab).

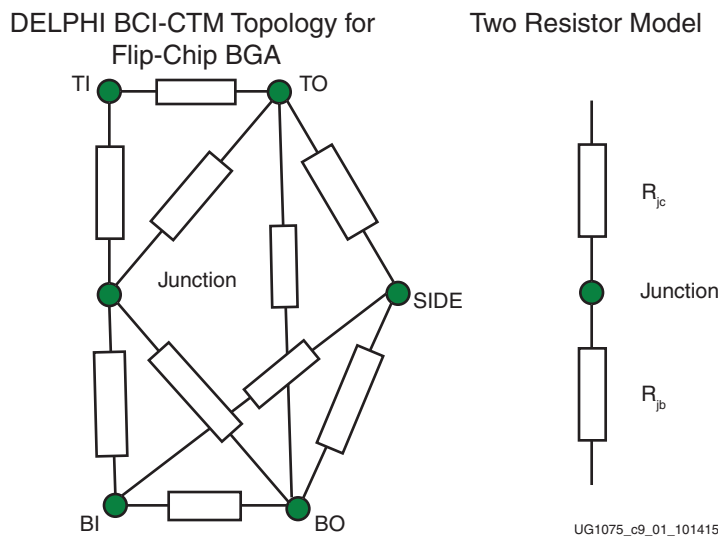

Figure 11-1: Thermal Model Topologies



RECOMMENDED: AMD recommends the use of the Delphi thermal model. AMD also recommends a best practice review of manufacturing variations on the thermal performance of the device from both the thermal interface material parameters and thermal solution variations. Examples of manufacture variations include the tolerance in airflow from a fan, the tolerance on performance of the heat pipe and vapor chamber, and manufacturing variations of the attachment of fins to the heat-sink base and the flatness of the surface.

Thermal Management Strategy

Introduction

As described in this section, AMD relies on a multi-pronged approach to consuming less power and dissipating heat for systems using Zynq™ UltraScale+™ devices.

Flip-Chip Packages

Zynq UltraScale+ devices are offered in flip-chip BGA packages, which present a low thermal path. With the exception of the bare-die packages, the flip-chip BGA packages incorporate a heat spreader with an additional thermal interface material (TIM), as shown in Figure 12-1.

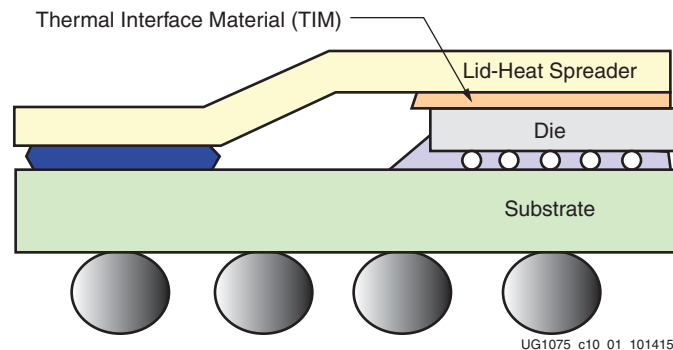

Figure 12-1: Heat Spreader with Thermal Interface Material

Materials with better thermal conductivity and consistent process deliver low thermal resistance to the heat spreader.

A parallel effort to ensure optimized package electrical return paths produces the added benefit of enhanced power and ground plane arrangement in the packages. A boost in copper density on the planes improves the overall thermal conductivity through the laminate. In addition, the extra dense and distributed via fields in the package increase the vertical thermal conductivity.

System Level Heat Sink Solutions

To complete a comprehensive thermal management strategy, an overall thermal budget that includes custom or OEM heat sink solutions depends on the physical and mechanical constraints of the system. A heat-sink solution, managed by the system-level designer, should be tailored to the design and specific system constraints. This includes understanding the inherent device capabilities for delivering heat to the surface.

By considering the system's physical, mechanical, and environmental constraints, the overall thermal budget is maintained and does not exceed the device's maximum operating temperature. The heat sink is an integral part of the thermal management solution to maintain a safe operating temperature. As a result, the system-level designer must be aware of the following:

- For lidless packages, the nominal stiffener height can be different from the height of the die. Therefore, the heat sink must have an island to contact the die.
- Especially for lidless packages, AMD advises against direct use of the θ_{JC} parameters (see [Table 11-1](#)) to determine the thermal performance of the device in your application. The calculation of these parameters are done in accordance with the JEDEC standard JESD51 where system parameters differ greatly from most applications. Instead, run thermal simulations of the system in worst-case environmental conditions using Delphi thermal models, which more accurately represent the device thermal performance under all boundary conditions.
- Consider the mechanical specifications of the package as well as the selection of the thermal interface between the die and the thermal management solution to ensure the lowest thermal contact resistance.
- The total thermal contact of the thermal interface material is determined based on parameters from the thermal interface supplier's data sheet.
- See the applied pressure recommendation on [page 324](#). Lower pressure runs the risk of poor thermal contact and higher pressure runs the risk of damaging the device; therefore, strict control of pressure is required.
- Consider all uncertainties in thermal modeling, including manufacturing variations from the thermal solutions (for example, fan airflow tolerance, heat pipe or vapor chamber performance tolerance, variation of the attachment of fins to heat sink base, and surface flatness).

Thermal Interface Material

When installing heat sinks for Zynq UltraScale+ devices, a suitable thermal interface material (TIM) must be used. This thermal material significantly aids the transfer of heat from the component to the heat sink.

For bare-die flip-chip BGAs, the surface of the silicon contacts the heat sink. For lidded flip-chip BGAs, the lid contacts the heat sink. The surface size of the bare-die flip-chip BGA and lidded flip-chip BGAs are different. AMD recommends a different type of thermal material for long-term use with each type of flip-chip BGAs package.

Thermal interface material is needed because even the largest heat sink and fan cannot effectively cool an Zynq UltraScale+ device unless there is good physical contact between the base of the heat sink and the top of the Zynq UltraScale+ device. The surfaces of both the heat sink and the Zynq UltraScale+ device silicon are not absolutely smooth. This surface roughness is observed when examined at a microscopic level. Because surface roughness reduces the effective contact area, attaching a heat sink without a thermal interface material is not sufficient due to inadequate surface contact.

A thermal interface material such as phase-change material, thermal grease, or thermal pads fills these gaps and allows effective transference of heat between the Zynq UltraScale+ device die and the heat sink.

The selection of the thermal interface (TIM) between the package and the thermal management solution is critical to ensure the lowest thermal contact resistance. Therefore, the following parameters must be considered.

1. The flatness of the lid and the flatness of the contact surface of the thermal solution.
2. The applied pressure of the thermal solution on the package, which must be within the allowable maximum pressure that can be applied on the package.
3. The total thermal contact of the thermal interface material. This value is determined based on the parameters in [step 1](#) and [step 2](#), which are published in the data sheet of the thermal interface supplier.

Types of TIM

There are many type of TIM available for sale. The most commonly used thermal interface materials are listed.

- Thermal grease
- Thermal pads
- Phase change material
- Thermal paste
- Thermal adhesives
- Thermal tape

Guidelines for Thermal Interface Materials

Five factors affect the choice, use, and performance of the interface material used between the processor and the heat sink:

- [Thermal Conductivity of the Material](#)
- [Electrical Conductivity of the Material](#)
- [Spreading Characteristics of the Material](#)
- [Long-Term Stability and Reliability of the Material](#)
- [Ease of Application](#)
- [Applied Pressure from Heat Sink to the Package via Thermal Interface Materials](#)

Thermal Conductivity of the Material

Thermal conductivity is the quantified ability of any material to transfer heat. The thermal conductivity of the interface material has a significant impact on its thermal performance. The higher the thermal conductivity, the more efficient the material is at transferring heat. Materials that have a lower thermal conductivity are less efficient at transferring heat, causing a higher temperature differential to exist across the interface. To overcome this less efficient heat transfer, a better cooling solution (typically, a more costly solution) must be used to achieve the desired heat dissipation.

Electrical Conductivity of the Material

Some metal-based TIM compounds are electrically conductive. Ceramic-based compounds are typically not electrically conductive. Manufacturers produce metal-based compounds with low-electrical conductivity, but some of these materials are not completely electrically inert. Metal-based thermal compounds are not hazardous to the Zynq UltraScale+ device die itself, but other elements on the Zynq UltraScale+ device or motherboard can be at risk

if they become contaminated by the compound. For this reason, AMD does not recommend the use of electrically conductive thermal interface material.

Spreading Characteristics of the Material

The spreading characteristics of the thermal interface material determines its ability, under the pressure of the mounted heat sink, to spread and fill in or eliminate the air gaps between the Zynq UltraScale+ device and the heat sink. Because air is a very poor thermal conductor, the more completely the interface material fills the gaps, the greater the heat transference.

Long-Term Stability and Reliability of the Material

The long-term stability and reliability of the thermal interface material is described as the ability to provide a sufficient thermal conductance even after an extended time or extensive. Low-quality compounds can harden or leak out over time (the pump-out effect), leading to overheating or premature failure of the Zynq UltraScale+ device. High-quality compounds provide a stable and reliable thermal interface material throughout the lifetime of the device. Thermal greases with higher viscosities are typically more resistant to pump out effects on bare-die devices.

Ease of Application

A spreadable thermal grease requires the surface mount supplier to carefully use the appropriate amount of material. Too much or too little material can cause problems. The thermal pad is a fixed size and is therefore easier to apply in a consistent manner.

Applied Pressure from Heat Sink to the Package via Thermal Interface Materials



IMPORTANT: *The following table shows the required applied pressure on the thermal interface material (TIM) between the package and the heat sink. Thermocouples should not be present between the package and the heat sink, as their presence will degrade the thermal contact and result in incorrect thermal measurements. The best practice is to select the appropriate pressure for the optimum thermal contact performance between the package and the thermal system solution, and the mechanical integrity of the package (with the thermal solution to pass all mechanical stress and vibration qualification tests).*

Table 12-1: Required Applied Pressure by Package Type

Package Type	Supported Pressure Range (PSI)
0.8 mm and 1.0 mm pitch	20 to 50 PSI
InFO packages (e.g., UBVA530)	3 to 20 PSI (underfill required)



RECOMMENDED: AMD recommends using dynamic mounting around the four corners of the device package. On the PCB, use a bracket clip as part of the heat sink attachment to provide mechanical package support. See [Figure 12-2](#).

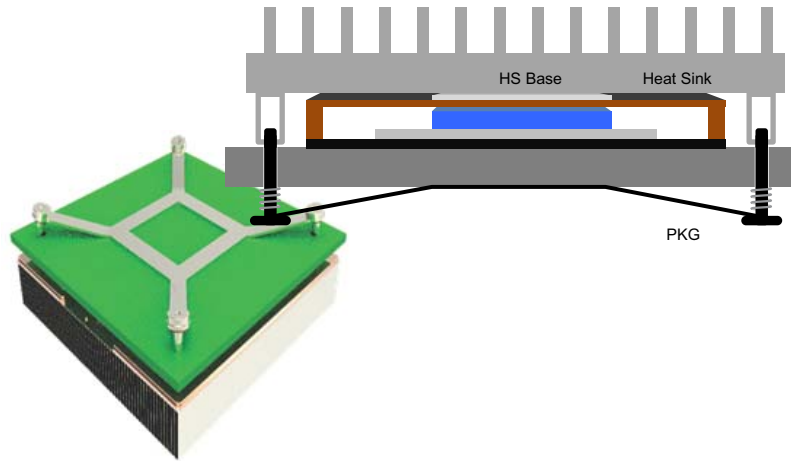

X15431-111316

Figure 12-2: Dynamic Mounting and Bracket Clips on Heat Sink Attachment

Heat Sink Removal

When removing or reworking heat sinks, the phase-change material residue must be removed from the surface of the die. Laird Technologies, Inc. provides the following guidance for complete removal of the phase-change material from the component.

Instructions for Removal of Phase-change Material

1. [Separate the Components](#)
2. [Scrape Away Thick Residue](#)
3. [Clean Remaining Residue with Solvent](#)
4. [Working with Laird Material](#)

Separate the Components

At room temperature, if possible, use a back and forth twisting motion to break the bond between the phase-change thermal interface material and mated components (i.e., heat sink and Zynq UltraScale+ device). See [Figure 12-3](#).

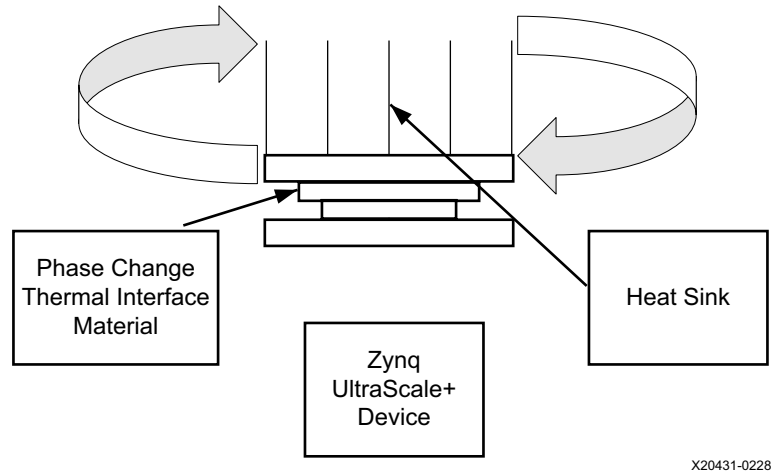

Figure 12-3: Breaking the Bond between Thermal Interface Material and Mated Components

For smaller components (typically 15 mm x 15 mm or less), the bond usually breaks free easily at room temperature. For larger components, in situations where minimal movement is available, or if using fragile components, heat the component (preferred) or heat sink to about 40°C–60°C before removal.

The guideline is 40°C–60°C, however, you might find that for your application, heating to 35°C is adequate. You might prefer to heat to 70°C which makes the phase-change thermal interface material very soft and the components can be easily separated.

Scrape Away Thick Residue

For a faster clean-up once components are separated, scrape away any large residual material amounts with a plastic spatula or a wooden tongue depressor. A clean dry rag can be used to wipe away excess material.

Clean Remaining Residue with Solvent

Using a clean cloth/wipe, wet it with your choice of solvent (see the following list) and wipe away any remaining residue.

- Toluene (easiest)
- Acetone (very good)
- Isoparaffinic hydrocarbon: Isopar, Soltrol (trade names) (very good)
- Isopropyl alcohol (OK)

Working with Laird Material

Safe handling, disposal, and first-aid measures for working with phase-change material are included in the Laird Technologies material safety data sheet (MSDS). Read the MSDS before using or handling. See the Laird Technologies, Inc. website, www.lairdtech.com.

Measurement Debug

When performing in-system thermal testing, to ensure accurate data and not incur damage to the device, do not place a thermocouple in between the device and the heat sink. On the extreme side, it might cause additional mechanical and/or thermal stress to the device, leading to damage. Even if damage does not occur, it often leads to a thicker and or uneven thermal interface material thickness, leading to a thermal performance difference from a system without a thermocouple. To obtain the device temperature, use the System Monitor as a non-invasive means to get accurate device measurements while debugging the system.

Heat Sink Guidelines for Bare-die Flip-Chip Packages

Heat Sink Attachments for Bare-die FB Packages

Heat sinks can be attached to the package in multiple ways. For heat to dissipate effectively, the advantages and disadvantages of each heat sink attachment method must be considered. Factors influencing the selection of the heat sink attachment method include the package type, contact area of the heat source, and the heat sink type.

Silicon and Decoupling Capacitors Height Consideration

When designing heat sink attachments for bare-die flip-chip BGA packages, the height of the die above the substrate and also the height of decoupling capacitors must be considered (Figure 13-1). This is to prevent electrical shorting between the heat sink (metal) and the decoupling capacitors.

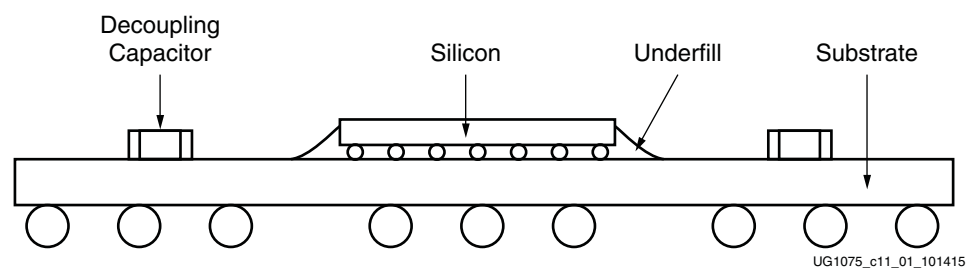

Figure 13-1: Cross Section of Bare-die Flip-chip BGA

Types of Heat Sink Attachments

There are six main methods for heat sink attachment. [Table 13-1](#) lists their advantages and disadvantages.

- [Thermal tape](#)
- [Thermally conductive adhesive or glue](#)
- [Wire form Z-clips](#)
- [Plastic clip-ons](#)
- [Threaded stand-offs \(PEMs\) and compression springs](#)
- [Push-pins and compression springs](#)

Table 13-1: Heat Sink Attachment Methods

Attachment Method	Advantages	Disadvantages
Thermal tape	<ul style="list-style-type: none"> • Generally easy to attach and is inexpensive. • Lowest cost approach for aluminum heat sink attachment. • No additional space required on the PCB. 	<ul style="list-style-type: none"> • The surfaces of the heat sink and the chip must be very clean to allow the tape to bond correctly. • Because of the small contact area, the tape might not provide sufficient bond strength. • Tape is a moderate to low thermal conductor that could affect the thermal performance.
Thermally conductive adhesive or glue	<ul style="list-style-type: none"> • Outstanding mechanical adhesion. • Fairly inexpensive, costs a little more than tape. • No additional space required on the PCB. 	<ul style="list-style-type: none"> • Adhesive application process is challenging and it is difficult to control the amount of adhesive to use. • Difficult to rework. • Because of the small contact area, the adhesive might not provide sufficient bond strength.
Wire form Z-clips	<ul style="list-style-type: none"> • It provides a strong and secure mechanical attachment. In environments that require shock and vibration testing, this type of strong mechanical attachment is necessary. • Easy to apply and remove. Does not cause the semiconductors to be destroyed (epoxy and occasionally tape can destroy the device). • It applies a preload onto the thermal interface material (TIM). Pre-loads actually improve thermal performance. 	<ul style="list-style-type: none"> • Requires additional space on the PCB for anchor locations.

Table 13-1: Heat Sink Attachment Methods (Cont'd)

Attachment Method	Advantages	Disadvantages
Plastic clip-ons	<ul style="list-style-type: none"> • Suitable for designs where space on the PCB is limited. • Easy to rework by allowing heat sinks to be easily removed and reapplied without damaging the PCB board. • Can provide a strong enough mechanical attachment to pass shock and vibration test. 	<ul style="list-style-type: none"> • Needs a keep out area around the silicon devices to use the clip. • Caution is required when installing or removing clip-ons because localized stress can damage the solder balls or chip substrate.
Threaded stand-offs (PEMs) and compression springs	<ul style="list-style-type: none"> • Provides stable attachments to heat source and transfers load to the PCB, backing plate, or chassis. • Suitable for high mass heat sinks. • Allows for tight control over mounting force and load placed on chip and solder balls. 	<ul style="list-style-type: none"> • Holes are required in the PCB taking valuable space that can be used for trace lines. • Tends to be expensive, especially since holes need to be drilled or predrilled onto the PCB board to use stand-offs.
Push-pins and compression springs	<ul style="list-style-type: none"> • Provides a stable attachment to a heat source and transfers load to the PCB. • Allows for tight control over mounting force and load placed on chip and solder balls. 	<ul style="list-style-type: none"> • Requires additional space on the PCB for push-pin locations.

Heat Sink Attachment

Component Pick-up Tool Consideration

For pick-and-place machines to place bare-die flip-chip BGAs onto PCBs, AMD recommends using soft tips or suction cups for the nozzles. This prevents chipping, scratching, or even cracking of the bare die (Figure 13-2).

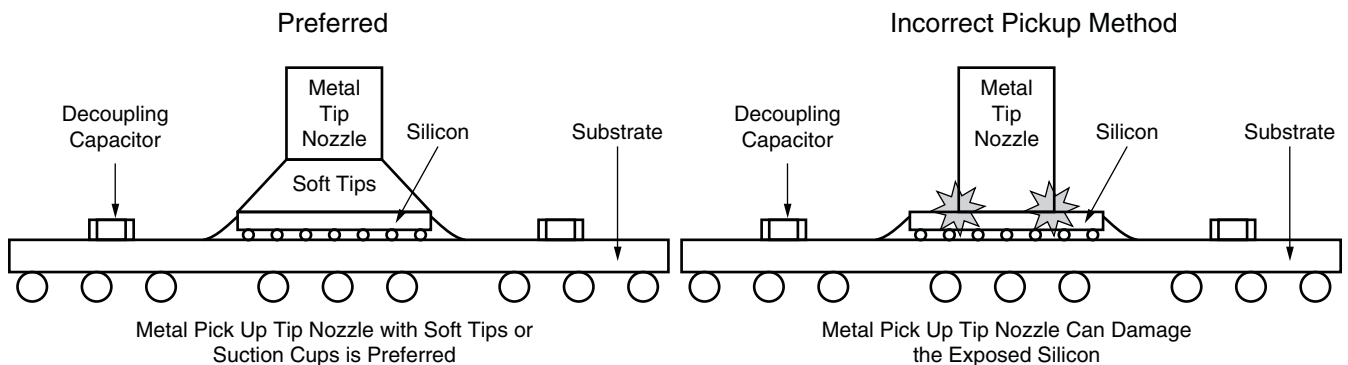

UG1075_c11_02_101415

Figure 13-2: Recommended Method For Using Pick-up Tools

Heat Sink Attachment Process Considerations

After the component is placed onto the PCBs, when attaching a heat sink to the bare-die package, the factors in [Table 13-2](#) must be carefully considered (see [Figure 13-3](#)).

Table 13-2: Heat Sink Attachment Considerations

Consideration(s)	Effect(s)	Recommendation(s)
In heat sink attach process, what factors can cause damage to the exposed die and passive capacitors?	<ul style="list-style-type: none"> • Uneven heat sink placement • Uneven TIM thickness • Uneven force applied when placing heat sink placement 	<ul style="list-style-type: none"> • Even heat sink placement • Even TIM thickness • Even force applied when placing heat sink placement
Does the heat sink tilt or tip the post attachment?	Uneven heat sink placement will damage the silicon and can cause field failures.	<ul style="list-style-type: none"> • Careful handling not to contact the heat sink with the post attachment. • Use a fixture to hold the heat sink in place with post attachment until it is glued to the silicon.

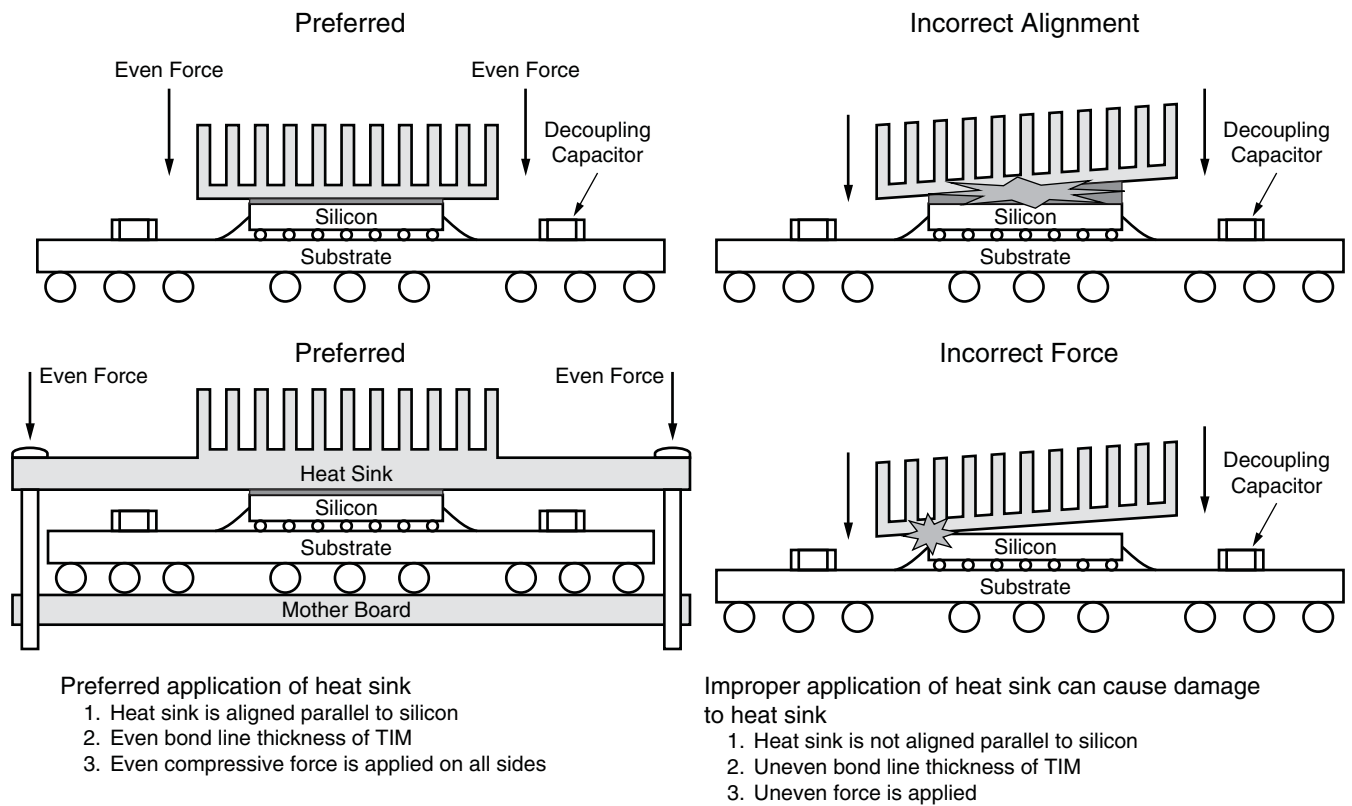

Figure 13-3: Recommended Application of Heat Sink

Standard Heat Sink Attach Process with Thermal Conductive Adhesive

Prior to attaching the heat sink, the Zynq UltraScale+ device needs be surface mounted on the motherboard.

1. Place the motherboard into a jig or a fixture to hold the motherboard steady to prevent any movement during the heat sink attachment process.
2. Thermoset material (electrically non-conductive) is applied over the backside surface of silicon in a pattern using automated dispensing equipment. Automated dispensers are often used to provide a stable process speed at a relatively low cost. The optimum dispensing pattern needs to be determined by the SMT supplier.

Note: Minimal volume coverage of the backside of the silicon can result in non-optimum heat transfer.

3. The heat sink is placed on the backside of the silicon with a pick and place machine. A uniform pressure is applied over the heat sink to the backside of the silicon. As the heat sink is placed, the adhesive spreads to cover the backside silicon. A force transducer is normally used to measure and limit the placement force.
4. The epoxy is cured with heat at a defined time.

Note: The epoxy curing temperature and time is based on manufacturer's specifications.

Standard Heat Sink Attach Process with Thermal Adhesive Tape

Prior to attaching the heat sink, the Zynq UltraScale+ device needs be surface mounted on the motherboard.

1. Place the motherboard into a jig or a fixture to hold the motherboard steady to prevent any movement during the heat sink attachment process.
2. Thermal adhesive tape cut to the size of the heat sink is applied on the underside of the heat sink at a modest angle with the use of a squeegee rubber roller. Apply pressure to help reduce the possibility of air entrapment under the tape during application.
3. The heat sink is placed on the backside of the silicon with a pick and place machine. A uniform pressure is applied over the heat sink to the backside of the silicon. As the heat sink is placed, the thermal adhesive tape is glued to the backside of the silicon. A force transducer is normally used to measure and limit the placement force.
4. A uniform and constant pressure is applied uniformly over the heat sink and held for a defined time.

Note: The thermal adhesive tape hold time is based on manufacturer's specifications.

Push-Pin and Shoulder Screw Heat Sink Attachment Process with Phase Change Material (PCM) Application

Prior to attaching the heat sink, the Zynq UltraScale+ device needs be surface mounted on the motherboard.

1. Place the motherboard into a jig or a fixture to hold the motherboard steady to prevent any movement during the heat sink attachment process.

Note: The jig or fixture needs to account for the push pin depth of the heat sink.

2. PCM tape, cut to the size of the heat sink, is applied on the underside of the heat sink at a modest angle with the use of a squeegee rubber roller. Apply pressure to help reduce the possibility of air entrapment under the tape during application.
3. Using the push-pin tool, heat sinks are applied over the packages ensuring a pin locking action with the PCB holes. The compression load from springs applies the appropriate mounting pressure required for proper thermal interface material performance.

Note: Heat sinks must not tilt during installation. This process cannot be automated due to the mechanical locking action which requires manual handling. The PCB drill hole tolerances need to be close enough to eliminate any issues concerning the heat sink attachment.

Additional Resources and Legal Notices

Finding Additional Documentation

Technical Information Portal

The AMD Technical Information Portal is an online tool that provides robust search and navigation for documentation using your web browser. To access the Technical Information Portal, go to <https://docs.amd.com>.

Documentation Navigator

Documentation Navigator (DocNav) is an installed tool that provides access to AMD Adaptive Computing documents, videos, and support resources, which you can filter and search to find information. To open DocNav:

- From the Vivado™ IDE, select **Help > Documentation and Tutorials**.
- On Windows, click the **Start** button and select **Xilinx Design Tools > DocNav**.
- At the Linux command prompt, enter `docnav`.

Note: For more information on DocNav, see the [Documentation Navigator](#) web page.

Design Hubs

AMD Design Hubs provide links to documentation organized by design tasks and other topics, which you can use to learn key concepts and address frequently asked questions. To access the Design Hubs:

- In DocNav, click the **Design Hubs View** tab.
- Go to the [Design Hubs](#) web page.

Support Resources

For support resources such as Answers, Documentation, Downloads, and Forums, see [Support](#).

References

1. *Zynq UltraScale+ MPSoC Overview* ([DS891](#))
2. *Zynq UltraScale+ RFSoc Overview* ([DS889](#))
3. *XQ UltraScale Architecture Data Sheet: Overview* ([DS895](#))
4. *XA Zynq UltraScale+ MPSoC Data Sheet: Overview* ([DS894](#))
5. Zynq UltraScale+ device [Packaging Specifications](#)
6. *UltraScale Architecture SelectIO Resources User Guide* ([UG571](#))
7. *UltraScale Architecture Clocking Resources User Guide* ([UG572](#))
8. *Zynq UltraScale+ MPSoC Data Sheet: DC and AC Switching Characteristics* ([DS925](#))
9. *Zynq UltraScale+ RFSoc Data Sheet: DC and AC Switching Characteristics* ([DS926](#))
10. *Zynq UltraScale+ Device Technical Reference Manual* ([UG1085](#))
11. *UltraScale Architecture GTH Transceiver User Guide* ([UG576](#))
12. *UltraScale Architecture GTY Transceiver User Guide* ([UG578](#))
13. *UltraScale Architecture System Monitor User Guide* ([UG580](#))
14. *UltraScale Architecture PCB Design Guide* ([UG583](#))
15. *UltraScale Architecture-Based Memory Interface Solutions Product Guide* ([PG150](#))
16. *UltraScale Architecture Configuration User Guide* ([UG570](#))
17. *FAQ: Top Marking Change for 7 Series, UltraScale, and UltraScale+ Products* ([XTP424](#))
18. *FAQ: Top Marking Change for 7 Series, UltraScale, and UltraScale+ Products* ([XTP544](#))
19. All published MDDS files are available on the [See All Package Specifications](#) page.

20. The following websites contain additional information on heat management and contact information.
- Wakefield: www.wakefield-vette.com
 - Aavid: www.aavid.com
 - Advanced Thermal Solutions: www.qats.com
 - Radian Thermal Products: www.radianheatsinks.com
 - Thermo Cool: www.thermoolcorp.com
 - CTS: www.ctscorp.com
21. Refer to the following websites for interface material sources:
- Henkel: www.henkel.com
 - Bergquist Company: www.bergquistcompany.com
 - AOS Thermal Compound: www.aosco.com
 - Chomerics: www.chomerics.com
 - Kester: www.kester.com
22. Refer to the following websites for CFD tools AMD supports with thermal models.
- Mentor Flotherm: www.mentor.com/products/mechanical/flotherm/flotherm/
 - ANSYS Icepak: www.ansys.com
23. Refer to the [Package Thermal Models](#) on xilinx.com.
24. The following papers are referenced for more information on thermal modeling.
- Lemczyk, T.F., Mack, B., Culham, J.R., and Yovanovich, M.M., 1992, "Printed Circuit Board Trace Thermal Analysis and Effective Conductivity", ASME J. Electronic Packaging, Vol. 114, pp. 413-419.50.
 - Refai-Ahmed, G. and Karimanal, K., 2003, "Validation of Compact Conduction Models of BGA Under Realistic Boundary," J. of Components and Packaging Technology, Vol. 26, No. 3, pp. 610-615.
 - Sansoucy, E., Refai-Ahmed, G., and Karimanal, K., 2002, "Thermal Characterization of TBGA Package for an integration in Board Level Analysis," Eighth Intersociety on Thermal Conference Phenomena in Electronic Systems, San Diego., USA.
 - Karimanal, K. and Refai-Ahmed, G., 2002, "Validation of Compact Conduction Models of BGA Under Realistic Boundary Conditions," Eighth Intersociety on Thermal Conference Phenomena in Electronic Systems, San Diego, USA.
 - Karimanal, K. and Refai-Ahmed, G., 2001, "Compact conduction Model (CCM) of Microelectronic Packages- A BGA Validation Study," APACK Conference on Advance in Packaging, Singapore.

Revision History

The following table shows the revision history for this document.

Date	Version	Revision
10/11/2024	1.13	<p>Added the XCZU4CG, XCZU4EG, XCZU4EV, XCZU5CG, XCZU5EG, XCZU5EV, XCZU63DR, and XCZU64DR devices throughout.</p> <p>Updated Figure 4-58, Figure 4-60, Figure 4-60, Figure 4-88, Figure 4-98, and Figure 4-100.</p> <p>Added notes to VCCAUX_IO pins for XQ devices to Figure 4-4, Figure 4-24, Figure 4-32, Figure 4-38, Figure 4-40, Figure 4-44, Figure 4-46, Figure 4-48, Figure 4-52, Figure 4-60, Figure 4-72, Figure 4-82, Figure 4-88, Figure 4-90, Figure 4-92, Figure 4-96, Figure 4-98.</p> <p>Updated the legend in Figure 4-14. Updated the diagram in Figure 4-16 and added the XQ specific note.</p> <p>Updated the M dimension in Figure 5-3. Added devices to Figure 5-9.</p> <p>Updated the XA devices in Table 8-3.</p> <p>Updated the 0.5 mm pitch values for L and M diameter design rules in Table 9-1.</p> <p>Moved the Conformal Coating section to Chapter 10. Updated the Edge Bonding Implementation section.</p> <p>Updated the supported pressure range for InFO packages in Table 12-1.</p>
2/23/2023	1.12	<p>Added the XCZU3TCG and XCZU3TEG devices throughout.</p> <p>Added the XAZU1EG device throughout. Added missing UBVA530 package and XQZU48DR (FFRE1156) device references throughout.</p> <p>Updated the ADC_VIN_[0 to 3 or _I01 and _I23]_[P or N] pin name in Table 1-4.</p> <p>In Chapter 10, updated the Summary and Edge Bonding Implementation sections (including new images) and added the Underfill Guidelines section.</p> <p>Moved Revision History location.</p>
1/18/2022	1.11	<p>Added the XCZU1CG, XCZU1EG, XCZU42DR, XCZU65DR, and XCZU67DR devices throughout document. Added XQZU48DR and XQZU49DR. Added the UBVA494, FSRG1517, and FSRF1760 packages where applicable.</p> <p>Chapter 1, Packaging Overview: Added Note 1 to Table 1-5 and updated links to Note 2 in Table 1-7. Updated and corrected bank diagrams Figure 1-42 and Figure 1-60.</p> <p>Chapter 2, PS Memory Interface Pin Guidelines: Corrected the Important note on page 105. Updated some of the descriptions in Table 2-1 and Table 2-2 to avoid confusion. In Table 2-4, corrected the PS_DDR_ODT1 for LPDDR3 64-bit entry (can be left unconnected).</p> <p>Chapter 5, Mechanical Drawings: Added links to the MDDS file information. Updated Figure 5-21 with the correct diagram.</p> <p>Chapter 8, Soldering Guidelines: Updated the Important note on page 287.</p> <p>Chapter 10, Edge Bonding and Underfill Guidelines: Added the Important note on page 301.</p> <p>Chapter 12, Thermal Management Strategy: Updated the Applied Pressure from Heat Sink to the Package via Thermal Interface Materials and added Table 12-1.</p>

Date	Version	Revision
7/01/2021	1.10	<p>Added InFO package (UBVA530) throughout.</p> <p>Chapter 5, Mechanical Drawings: Added Figure 5-21 and Figure 5-22. Updated A_3 and A_4 dimensions in Figure 5-21, Figure 5-29, and Figure 5-34.</p> <p>Chapter 8, Soldering Guidelines: Updated Pb-Free Reflow Soldering to include Table 8-2, Figure 8-3, and Figure 8-4. Added the Strain Gauge Measurement, Solder Paste, and Component Placement sections.</p> <p>Chapter 9, Recommended PCB Design Rules for BGA Packages: Added Stencil section.</p> <p>Chapter 10, Edge Bonding and Underfill Guidelines: Added chapter.</p>
6/24/2020	1.9	<p>Added the XCZU43DR, XCZU47DR, XCZU46DR, XCZU48DR, and XCZU49DR devices throughout document. Added the FVH1760 and FSVH1760 packages throughout document.</p> <p>Chapter 2, PS Memory Interface Pin Guidelines: Updated the DDR3/3L Pinout Example for Supported Configurations, DDR4 Pin Rules, DDR4 Pinout Example for Supported Configurations, and LPDDR3 Pinout Example for Supported Configurations sections. Clarified the headings in Table 2-4 and updated the LPDDR3 64-bit column for PS_DDR_CKE0, PS_DDR_CKE1, PS_DDR_CS_N0, and PS_DDR_ODT0.</p> <p>Chapter 6, Package Marking: Added a new top-mark diagram (Figure 6-1).</p> <p>Chapter 8, Soldering Guidelines: Updated and removed notes linking to data sheets for reflow body temperatures.</p> <p>Chapter 11, Thermal Specifications: Added links to Package Thermal Data Query for thermal simulation data.</p>
7/12/2019	1.8	<p>Added the XAZU7EV, XAZU11EG, XCZU39DR, XQZU3EG, XQZU9EG, XQZU11EG, XQZU19EG, XQZU21DR, XQZU28DR, and XQZU29DR devices throughout. Added the SFRA484, FFRD1156, FFRE1156, FFRB1517, FFRG1517, FFRC1760, and FFRF1760 packages where applicable.</p> <p>Updated the recommended applied pressure range on page 324.</p>

Date	Version	Revision
1/31/2019	1.7	<p>Chapter 1: Added an Important Note about XQ devices with eutectic BGA balls on page 8. Added the XQZU5EV (SFRC784, FFRB900), XQZU7EV (FFRB900, FFRC1156), and XQZU15EG (FFRC900, FFRB1156) device/package combinations to Table 1-1, Table 1-2, Table 1-3, Table 1-7, Table 1-8, and the associated bank diagram figures in this section. In Table 1-4, added the type and direction data for VCCO_PSIO[0:3]_ [500:503] and VCCO_PSDDR. Added a note for XQ ruggedized packages to VCCAUX_IO. Revised the GTH Quad 229 coordinates in Figure 1-27. Fixed GTH Quad location errors in Figure 1-33 through Figure 1-35.</p> <p>Chapter 2: Updated the DDR3/3L Pinout Example for Supported Configurations description and added VCCO_PSDDR and Note 1 to Table 2-1. Updated the DDR4 Pinout Example for Supported Configurations description and added VCCO_PSDDR to Table 2-2 and Note 1. Also in Table 2-2, added to guidelines for PS_DDR_A17, and PS_DDR_DQ32 to PS_DDR_DQ63. Updated the LPDDR4 Pinout Example for Supported Configurations description and added VCCO_PSDDR to Table 2-3 and Note 1. Updated the LPDDR3 Pinout Example for Supported Configurations description and added VCCO_PSDDR to Table 2-4 and Note 1.</p> <p>Chapter 3: Added an Important Note about XQ devices with eutectic BGA balls on page 127. Added the XQZU5EV (SFRC784, FFRB900), XQZU7EV (FFRB900, FFRC1156), and XQZU15EG (FFRC900, FFRB1156) device/package combinations to Table 3-1 labeled as production.</p> <p>Chapter 4: Added an Important Note about XQ devices with eutectic BGA balls on page 132. In Table 4-1, added the XQZU5EV (SFRC784, FFRB900), XQZU7EV (FFRB900, FFRC1156), and XQZU15EG (FFRC900, FFRB1156) device/package combinations.</p> <p>Chapter 5: Added an Important Note about XQ devices with eutectic BGA balls on page 240. In Table 5-1, added the XQZU5EV (SFRC784, FFRB900), XQZU7EV (FFRB900, FFRC1156), and XQZU15EG (FFRC900, FFRB1156) device/package combinations. Added Figure 5-8, Figure 5-13, Figure 5-16, and Figure 5-17.</p> <p>Chapter 6: Updated Table 6-1 and added Figure 6-3.</p> <p>Chapter 7: Added an Important Note about XQ devices with eutectic BGA balls on page 286. In Table 7-1, added the ruggedized packages (SFRC784, FFRB900, FFRC900, FFRB1156, and FFRC1156).</p> <p>Chapter 8: Updated the chapter with more information on eutectic packages including adding the Sn/Pb Reflow Soldering section. In Table 8-3, added the ruggedized packages (SFRC784, FFRB900, FFRC900, FFRB1156, and FFRC1156).</p> <p>Chapter 11: Added an Important Note about XQ devices with eutectic BGA balls on page 314. In Table 11-1, added the XQZU5EV (SFRC784, FFRB900), XQZU7EV (FFRB900, FFRC1156), and XQZU15EG (FFRC900, FFRB1156) device/package combinations.</p>

Date	Version	Revision
8/20/2018	1.6	<p>Chapter 1: Added the XAZU4EV and XAZU5EV devices in the SFVC784 package. This includes updates to Table 1-2, Table 1-3, Table 1-5, Table 1-7, Table 1-8, Figure 1-17, and Figure 1-18. Corrected the VCCO_PSDDR pin name (from VCCO_PSDDR_504) in Table 1-4. Added a note to Figure 1-10 on page 53.</p> <p>Chapter 2: Clarified what a byte lane includes in the pin swapping restrictions discussions on page 105 and page 109.</p> <p>Chapter 3: Added the XAZU4EV and XAZU5EV devices to Table 3-1. Labeled all of the devices in Table 3-2 as production.</p> <p>Chapter 4: In Table 4-1, added the XAZU4EV and XAZU5EV devices and changed the XCZU21DR, XCZU25DR, XCZU27DR, XCZU28DR, and XCZU29DR device labels to production. Added a note above Figure 4-3 on page 140. Added the XAZU4EV and XAZU5EV devices in the SFVC784 package to Figure 4-23 and Figure 4-24.</p> <p>Chapter 5: Added the XAZU4EV and XAZU5EV devices to Table 5-1 and Figure 5-9. Labeled all of the devices in Table 5-2 as production.</p> <p>Chapter 11: Added the XAZU4EV and XAZU5EV devices to Table 11-1.</p>
4/10/2018	1.5	<p>Chapter 1: Added the XCZU21DR, XCZU25DR, XCZU27DR, XCZU28DR, and XCZU29DR devices. This includes updates to Table 1-1, Table 1-2, Table 1-3, Table 1-4, Table 1-5, Table 1-7, and Table 1-8. Added Figure 1-42 through Figure 1-53.</p> <p>Chapter 3: Added the XCZU21DR, XCZU25DR, XCZU27DR, XCZU28DR, and XCZU29DR ASCII file links, see Table 3-2.</p> <p>Chapter 4: Added the XCZU21DR, XCZU25DR, XCZU27DR, XCZU28DR, and XCZU29DR devices to Table 4-1.</p> <p>Chapter 5: Added the XCZU21DR, XCZU25DR, XCZU27DR, XCZU28DR, and XCZU29DR mechanical drawings, see Table 5-2.</p> <p>Chapter 7: Added the FFVD1156, FFVE1156, FSVE1156, FFVG1517, FSVG1517, FFVF1760, and FSVF1760 packages to Table 7-1.</p> <p>Chapter 8: Revised the guidelines in Table 8-1 for Ramp-up rate, Peak temperature (lead/ball), and Peak temperature (body). Revised the same information in Figure 8-2. Added the FFVD1156, FFVE1156, FSVE1156, FFVG1517, FSVG1517, FFVF1760, and FSVF1760 packages to Table 8-3.</p> <p>Chapter 11: Added the XCZU21DR, XCZU25DR, XCZU27DR, XCZU28DR, and XCZU29DR devices to Table 11-1 and added Note 1.</p> <p>Chapter 12: Updated the System Level Heat Sink Solutions section and added the Heat Sink Removal and Measurement Debug sections.</p>

Date	Version	Revision
12/21/2017	1.4	<p>Added the XAZU2EG and XAZU3EG devices throughout the document.</p> <p>Chapter 1: Revise the VCCINT_VCU description in Table 1-4. Updated the ZU11EG (Figure 1-28 through Figure 1-32) PCIe4 bank coordinates.</p> <p>Chapter 2: Updated LPDDR4 Pin Swapping Restrictions and DDR4 Pin Swapping Restrictions and removed Figure 2-1: DDR Controller Implementation of DQ Mapping. In Table 2-2, updated the PS_DDR_ZQ connections.</p> <p>Chapter 5: Revised Figure 5-10: Symbol A from (2.57/2.77/2.97) to (2.48/2.68/2.88) and Symbol A2 from (1.27/1.42/1.62) to (1.18/1.33/1.48).</p> <p>Chapter 6: Revised the top mark diagram to show both older device versions and newer ones with a 2D bar code.</p> <p>Chapter 8: Added an Important note on page 287 about reflow rework.</p> <p>Chapter 11: Updated the SFVC784, FFVC900, FFVB1156, FFVC1156, FFVB1517, FFVF1517 data to account for the stamped lid in Table 11-1.</p>
8/29/2017	1.3	<p>In Chapter 1, updated Figure 1-10, Figure 1-25, Figure 1-26, Figure 1-27, Figure 1-33, Figure 1-34, Figure 1-35, Figure 1-36, Figure 1-37, Figure 1-38, Figure 1-39, and Figure 1-40. Revise the VCCINT_VCU description in Table 1-4.</p> <p>In Chapter 2, updated the DDR4 Pin Rules and the DDR4 Pin Swapping Restrictions. In Table 2-2, updated the configurations for PS_DDR_CK_N1 (DDR4 1Rank).</p> <p>In Chapter 3, updated the package specification designation of many of the packages listed in Table 3-1.</p> <p>In Chapter 4, updated Table 4-1 and added the following device diagrams: SFVC784 Package-XCZU4CG, XCZU4EG, XCZU5CG, and XCZU5EG, SFVC784 Package-XCZU4EV, XCZU5EV, XAZU4EV, and XAZU5EV, FBVB900 Package-XCZU4CG, XCZU4EG, XCZU5CG, and XCZU5EG, FBVB900 Package-XCZU4EV and XCZU5EV, FFVF1517 Package-XCZU7CG and XCZU7EG, FFVC1156 Package-XCZU7EV, FFVC1156 Package-XCZU11EG, FFVB1517 Package-XCZU11EG, FFVF1517 Package-XCZU11EG, and FFVC1760 Package-XCZU11EG.</p> <p>In Chapter 5, replaced Figure 5-9, added Figure 5-10, Figure 5-11, Figure 5-25, and Figure 5-36.</p> <p>In Table 8-3, update the FFV packages to a mass reflow of 245°C.</p>
1/13/2017	1.2	<p>Added the following devices throughout: XCZU2CG, XCZU3CG, XCZU4CG, XCZU4EG, XCZU5CG, XCZU5EG, XCZU6CG, XCZU7CG, XCZU7EG, and XCZU9CG. In Table 1-3, revised the available PS I/O pin values for the SBVA484 and SFVA625 packages. In Table 1-4, updated the PS_MODE directions and the pin descriptions in the Power/Ground Pins section. In Table 1-7, revised the XCZU4 bank numbers and updated the FBVB900 mapping. Revised the mapping for the FBVB900 package in Table 1-8. Revised the Bank Locations of Dedicated and Multi-Function Pins section. Updated the HD I/O bank numbers in Figure 1-32.</p> <p>Added Chapter 2, PS Memory Interface Pin Guidelines. Added the Chapter 3, Package Specifications Designations section. In Table 3-1, updated links. Chapter 4, Device Diagrams and Chapter 5, Mechanical Drawings have updated tables and new diagrams. Revised the Bar Code section of Table 6-1 to include changes outlined in XCN16014: Top Marking change for 7 Series, UltraScale, and UltraScale+ Products. Updated the AUTOMOTIVE APPLICATIONS DISCLAIMER.</p>

Date	Version	Revision
6/14/2016	1.1	In Table 1-3 , updated Note 1 and the SBVA484 package total user HP I/Os. Clarified the I2C_SCLK and I2C_SDA descriptions and added SMBALERT and VCCINT_VCU to Table 1-4 . Also updated the Multi-gigabit Serial Transceiver Pins (GTHE4, GTYE4, and PS-GTR) descriptions, Added further descriptions in the Die Level Bank Numbering Overview including adding an example device diagram (Figure 1-3). In Chapter 4 , added new figures and updated all of the graphics because the PERSTN pins and SMBALERT pins have moved. Updated Figure 5-16 and added Figure 5-18 . Added the bar code description in Chapter 6 .
1/20/2016	1.0.2	Replaced the missing graphics in Chapter 1 .
12/18/2015	1.0.1	Updated the package file links in Chapter 3 .
11/24/2015	1.0	Initial AMD release.

Please Read: Important Legal Notices

The information presented in this document is for informational purposes only and may contain technical inaccuracies, omissions, and typographical errors. The information contained herein is subject to change and may be rendered inaccurate for many reasons, including but not limited to product and roadmap changes, component and motherboard version changes, new model and/or product releases, product differences between differing manufacturers, software changes, BIOS flashes, firmware upgrades, or the like. Any computer system has risks of security vulnerabilities that cannot be completely prevented or mitigated. AMD assumes no obligation to update or otherwise correct or revise this information. However, AMD reserves the right to revise this information and to make changes from time to time to the content hereof without obligation of AMD to notify any person of such revisions or changes. THIS INFORMATION IS PROVIDED "AS IS." AMD MAKES NO REPRESENTATIONS OR WARRANTIES WITH RESPECT TO THE CONTENTS HEREOF AND ASSUMES NO RESPONSIBILITY FOR ANY INACCURACIES, ERRORS, OR OMISSIONS THAT MAY APPEAR IN THIS INFORMATION. AMD SPECIFICALLY DISCLAIMS ANY IMPLIED WARRANTIES OF NON-INFRINGEMENT, MERCHANTABILITY, OR FITNESS FOR ANY PARTICULAR PURPOSE. IN NO EVENT WILL AMD BE LIABLE TO ANY PERSON FOR ANY RELIANCE, DIRECT, INDIRECT, SPECIAL, OR OTHER CONSEQUENTIAL DAMAGES ARISING FROM THE USE OF ANY INFORMATION CONTAINED HEREIN, EVEN IF AMD IS EXPRESSLY ADVISED OF THE POSSIBILITY OF SUCH DAMAGES.

AUTOMOTIVE APPLICATIONS DISCLAIMER

AUTOMOTIVE PRODUCTS (IDENTIFIED AS "XA" IN THE PART NUMBER) ARE NOT WARRANTED FOR USE IN THE DEPLOYMENT OF AIRBAGS OR FOR USE IN APPLICATIONS THAT AFFECT CONTROL OF A VEHICLE ("SAFETY APPLICATION") UNLESS THERE IS A SAFETY CONCEPT OR REDUNDANCY FEATURE CONSISTENT WITH THE ISO 26262 AUTOMOTIVE SAFETY STANDARD ("SAFETY DESIGN"). CUSTOMER SHALL, PRIOR TO USING OR DISTRIBUTING ANY SYSTEMS THAT INCORPORATE PRODUCTS, THOROUGHLY TEST SUCH SYSTEMS FOR SAFETY PURPOSES. USE OF PRODUCTS IN A SAFETY APPLICATION WITHOUT A SAFETY DESIGN IS FULLY AT THE RISK OF CUSTOMER, SUBJECT ONLY TO APPLICABLE LAWS AND REGULATIONS GOVERNING LIMITATIONS ON PRODUCT LIABILITY.

© Copyright 2015–2024 Advanced Micro Devices, Inc. AMD, the AMD Arrow logo, Kintex, UltraScale, UltraScale+, Virtex, Vivado, Zynq, and combinations thereof are trademarks of Advanced Micro Devices, Inc. AMBA, AMBA Designer, Arm, ARM1176JZ-S, CoreSight, Cortex, PrimeCell, Mali, and MPCore are trademarks of Arm Limited in the EU and other countries. PCI, PCIe, and PCI Express are trademarks of PCI-SIG and used under license. Other product names used in this publication are for identification purposes only and may be trademarks of their respective companies.

Looking for pricing, stock, or lifecycle information?

Click below to explore more details on WIN SOURCE:

 [View XCZU2EG-1SFVA625E on WIN SOURCE](#)

 [Amd Information](#)

Optimize Your Supply Chain with WIN SOURCE Solutions

-  Global Sourcing Solution
-  Obsolete Management
-  Cost Control Management
-  Shortage Management
-  Alternative Solution
-  Excess Inventory Management