



Clearance/Creepage 8mm **CZ-3AG4** 3V Output Accurate Coreless Current Sensor

1. General Description

CZ-3AG4 is an open-type current sensor using Hall sensors, which outputs the analog voltage proportional to the AC/DC current. Group III-V semiconductor thin film is used as the Hall sensor, which enables the high-accuracy and high-speed current sensing. Coreless ultra-small surface mount package realizes the space-saving. Also, the low primary conductor resistance suppresses heat generation to achieve the 50A_{rms} continuous current. Existing coreless current sensors have an accuracy disadvantage from degradations caused by a disturbed magnetic field. The CZ-3AGx series has a built-in stray magnetic field reduction function to suppress this effect. The CZ-3AGx series also has dual overcurrent detection function. The CZ-3AGx series is UL 61800-5-1 safety compliant, which is an excellent fit for industrial AC drives, servo motors, etc. The CZ-3AGx series is also an excellent fit to input the sensor signal into a 3V AD converter. The CZ-3AGx series has a large variety of linear sensing ranges, from ±11.6A (CZ-3AG1), to ±116.6A, (CZ-3AG7). This enables designers to use the same board design across different current rating products.

2. Features

- Compliant with safety standard of UL61800-5-1 (Clearance, Creepage distance \geq 8.0mm)
- Certified with safety standards of UL-1577 and IEC/UL62368-1.
- 3V Output
- Maximum Primary Current : 50A_{rms}
- High-accuracy : 0.3%F.S.(T_a=35~85°C Typ.)
- Quite small primary conductor resistance : 0.27mΩ Typ.
- Stray magnetic field reduction function
- Small-sized surface mount package (12.7mm×10.9mm×2.25mm)
- Dual overcurrent detection function (Adjustable overcurrent detection thresholds)
- Isolation Voltage : 3.0kV_{rms} (AC50Hz, 60s)
- Non-ratiometric output



3. Applications

- AC drives
- DC motors
- UPS
- General Inverters
- Power conditioners

Also, CZ-3AG4 is suitable for other applications which are required isolation with small size and suppressing heat generation.

4. Table of Contents

1.	General Description.....	1
2.	Features.....	1
3.	Applications	2
4.	Table of Contents.....	2
5.	Block Diagram and Functions	3
6.	Pin Configurations and Functions	4
7.	Absolute Maximum Ratings.....	5
8.	Recommended Operating Conditions.....	5
9.	Electrical Characteristics	6
10.	Characteristic Definitions.....	9
11.	External Circuits Example	14
12.	Board Layout for Measuring Thermal Resistance.....	15
13.	Package.....	16
14.	Reliability Tests.....	19
15.	Precautions.....	20
16.	Revision History.....	21
	IMPORTANT NOTICE	22

5. Block Diagram and Functions

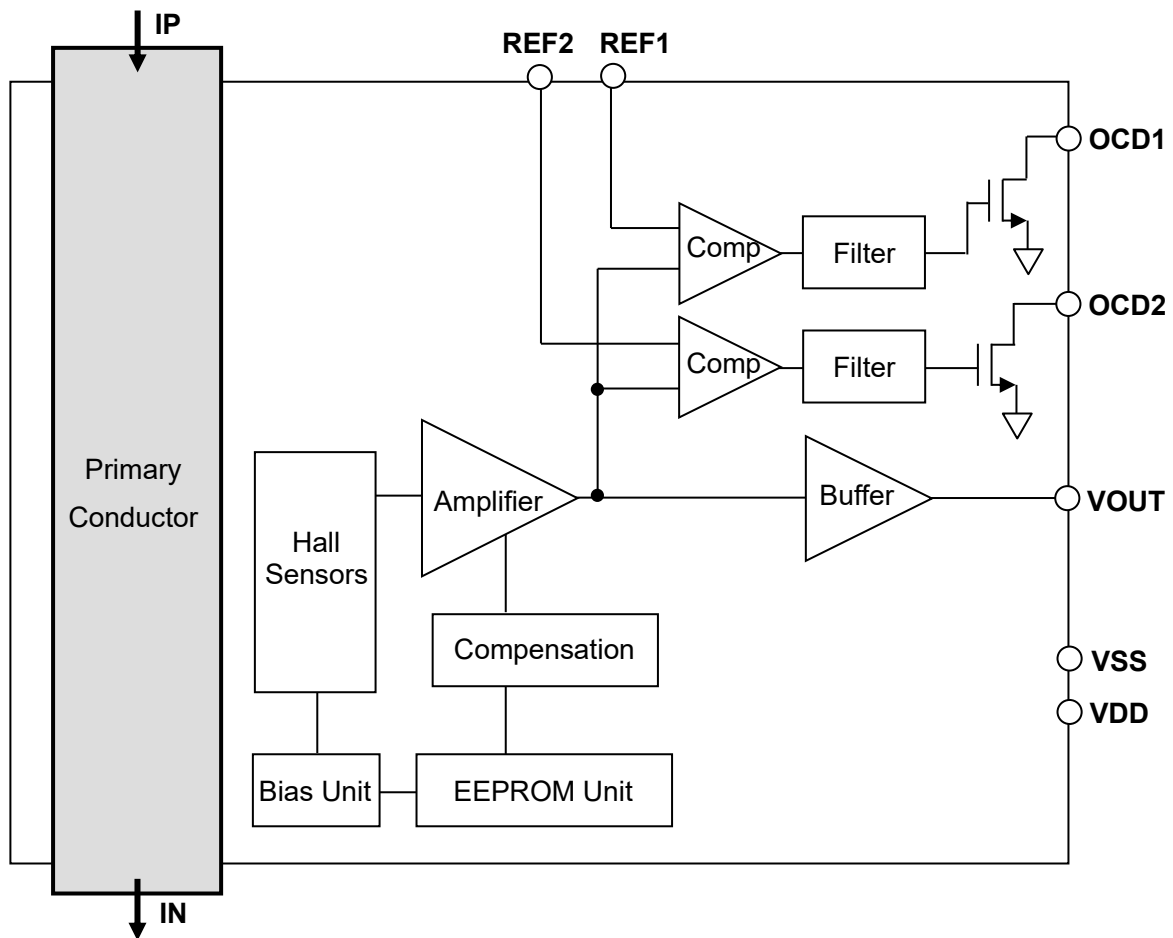

Figure 1. Block diagram of CZ-3AG4

Table 1. Explanation of circuit blocks

Circuit Block	Function
Primary Conductor	A device has the primary conductor built-in.
Hall Sensors	Hall elements which detect magnetic flux density generated from the measured current.
Amplifier	Amplifier of Hall elements' output.
Buffer	Output buffer with gain. This block outputs the voltage (V_{OUT}) proportional to the current applied to the primary conductor.
Comp (Comparator)	Comparator circuit which detects the overcurrent.
Filter	Filter which determines the overcurrent response time.
Compensation	Compensation circuit which adjusts the temperature drifts of sensitivity and zero-current voltage.
Bias Unit	Drive circuit for Hall elements.
EEPROM Unit	Non-volatile memory for setting adjustment parameters.

6. Pin Configurations and Functions

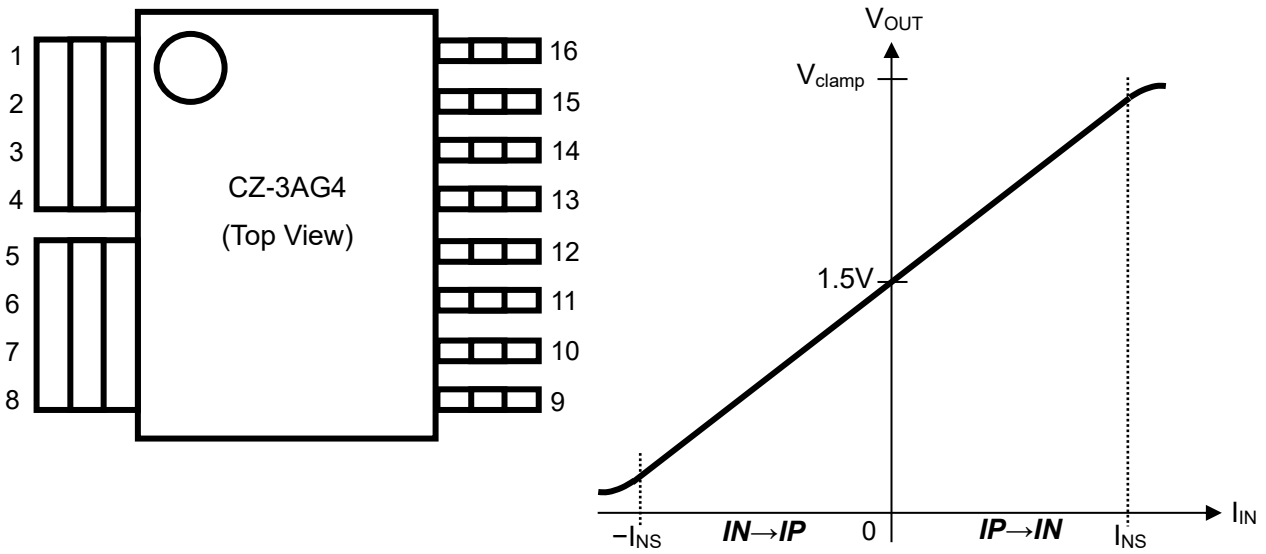

Figure 2. Pin configurations and typical output characteristics of CZ-3AG4

Table 2. Pin configuration and functions of CZ-3AG4

Pin No.	Pin Name	I/O	Type	Function
1,2,3,4	IP	I	—	Primary conductor pin (+)
5,6,7,8	IN	I	—	Primary conductor pin (-)
9	VSS	GND	Power	Ground pin (GND)
10	OCD1	O	Digital	The overcurrent detection output pin 1, open drain output Normal output: "H", Overcurrent detection: "L"
11	OCD2	O	Digital	The overcurrent detection output pin 2, open drain output. Normal output: "H", Overcurrent detection: "L"
12	VOU	O	Analog	Sensor output pin
13	VDD	PWR	Power	Power supply pin (5V)
14	REF1	I	Analog	Analog input pin to adjust the overcurrent threshold 1
15	REF2	I	Analog	Analog input pin to adjust the overcurrent threshold 2
16	VSS	GND	Power	Ground pin (GND)

7. Absolute Maximum Ratings

Table 3. Absolute maximum ratings

Parameter	Symbol	Min.	Max.	Units	Notes
Supply Voltage	V_{DD}	-0.3	6.5	V	VDD pin
Analog Output Current	I_{AOUT}	-10	10	mA	VOUT pin
Digital Output Current	I_{DOUT}	-10	10	mA	OCD1 pin, OCD2 pin
Analog Input Voltage	V_{AIN}	-0.3	$V_{DD}+0.3$	V	REF1 pin, REF2 pin
Pull Up Voltage at OCD Output	V_{OCDP}	-0.3	6.2	V	OCD1 pin, OCD2 pin
Junction Temperature	T_j	-40	125	°C	
Storage Temperature	T_{STG}	-40	125	°C	

WARNING:

Operation at or beyond these limits may result in permanent damage to the device. Normal operation is not guaranteed at these extremes.

8. Recommended Operating Conditions

Table 4. Recommended operating conditions

Parameter	Symbol	Min.	Typ.	Max.	Units	Notes
Supply Voltage	V_{DD}	4.5	5.0	5.5	V	VDD pin
Sensor Output Load Capacitance	C_{LVOUT}			1000	pF	Between VOUT pin and VSS pin
Overcurrent Detection Output Load Capacitance	$C_{LV OCD}$			1000	pF	Between OCD1 pin and VSS pin Between OCD2 pin and VSS pin
Sensor Output Load Current	I_{LVOUT}	-2		2	mA	VOUT pin
Pull Up Resistance at Overcurrent Detection Output	R_{OCD}	0.6	1		k Ω	OCD1 pin, OCD2 pin
Pull Up Voltage at Overcurrent Detection Output	V_{OCDP}	3.0		5.5	V	OCD1 pin, OCD2 pin
Analog Input Voltage	V_{REF1}	300		1620	mV	REF1 pin
	V_{REF2}	300		1400	mV	REF2 pin
Operating Ambient Temperature	T_a	-40		85	°C	
Maximum Primary Current (RMS)	I_{RMSmax}			50	A_{rms}	Continuous DC value or RMS value which can be applied to primary conductor

WARNING:

Electrical characteristics are not guaranteed when operated at or beyond these conditions.

Thermal Resistance junction to ambient θ_{ja} is described in 9. Electrical Characteristics.

9. Electrical Characteristics

Table 5. Electrical Characteristics

Conditions(unless otherwise specified) : $T_a=35^{\circ}\text{C}$, $V_{DD}=5\text{V}$

Parameter	Symbol	Conditions	Min.	Typ.	Max.	Units
Current Consumption	I_{DD}	$I_{IN}=0\text{A}$, No loads		17		mA
Sensitivity Note 1)	V_h	$I_{IN}=\pm 25\text{A}$ ($I_{IN}\leq 5\text{A}$ 1ms, $I_{IN}> 5\text{A}$ 500 μs) $V_h=(V_{OUT})/1\text{A}$		48		mV/A
Zero-Current Output Voltage Note 1)	V_{of}	$I_{IN}=0\text{A}$	1.49	1.5	1.51	V
Linear Sensing Range Note 2)	I_{NS}		-29.1		29.1	A
Output Saturation Voltage H Note 3)	V_{satH}	$I_{OUT}=\pm 2\text{mA}$	2.9			V
Output Saturation Voltage L Note3)	V_{satL}	$I_{OUT}=\pm 2\text{mA}$			0.1	V
Linearity Error Note 1)	ρ	$I_{IN}=\pm 25\text{A}$ ($I_{IN}\leq 5\text{A}$ 1ms, $I_{IN}> 5\text{A}$ 500 μs) $I_{OUT}=\pm 2\text{mA}$	-0.6		0.6	%F.S.
Output Clamp Voltage	V_{clamp}	$I_{OUT}=\pm 2\text{mA}$	3.0	3.25	3.45	V
PSRR Note4)	P_{srr}	DC to 100kHz		45		dB
Rise Response Time Note 3)	t_r	I_{IN} 90% to V_{OUT} 90%, $C_{LVOUT}=1000\text{pF}$		3.6		μs
Fall Response Time Note 3)	t_f	I_{IN} 10% to V_{OUT} 10%, $C_{LVOUT}=1000\text{pF}$		3.6		μs
Input Current Equivalent Noise	I_{Nrms}	$I_{IN}=0\text{A}$, 100Hz~120kHz		25		mA_{rms}
Power-on Time	t_{on}	$I_{IN}=0\text{A}$, V_{DD} 5V to V_{OUT} within $\pm 10\%$ of convergence value. (V_{DD} rise speed 5V/20 μsec)			2	ms
Stray Magnetic Field Reduction	E_{bc}	Equivalent to Zero-Current output drift -10mT < Stray Magnetic Field <10mT		0.01		A/mT
dV/dt Settling Time Note 2) Note 5)	t_{dVdt}	200V/ μs 200V		4		μs
Primary Conductor Resistance	R_P			0.27		m Ω
Thermal Resistance junction to ambient	θ_{ja}	Board Layout is Figure 8. ex. Input current=30A ΔT $=0.27 \times 30^2 \times 32 / 1000 = 7.8^{\circ}\text{C}$		32		$^{\circ}\text{C} / \text{W}$
Isolation Voltage Note 6)	V_{INS}	AC50Hz, 60s	3.0			kV_{rms}
Isolation Resistance Note 2)	R_{INS}	DC1kV	500			M Ω
Retention Time of EEPROM data Note 2)	EEP_{RT}	$T_j < 98^{\circ}\text{C}$	10			Year

Table 6. Electrical Characteristics (Overcurrent detection function characteristics 1)

Conditions(unless otherwise specified) : $T_a=35^{\circ}\text{C}$, $V_{DD}=5\text{V}$

Parameter	Symbol	Conditions	Min.	Typ.	Max.	Units
Overcurrent Detection Output Voltage 1	V_{OCD1}	$R_{OCD}=1\text{k}\Omega$			$0.1 \times V_{OCDP}$	V
ON-Resistance at Overcurrent Detection Output 1	R_{SOCD1}			12		Ω
Overcurrent Detection Threshold 1 Adjustable Range Note7)	$ I_{OCDTH1} $		14.6		36.4	A
Overcurrent Detection Response Time 1 Note3)	t_{RSOCD1}	$R_{OCD} = 1\text{k}\Omega$ $C_{LOCD} = 1000\text{pF}$		5.5	6.7	μs
Overcurrent Detection Threshold 1 Adjustment Error Note3), Note8)	E_{OC1}	$ I_{OCDTH1} = 36.4\text{A}$		± 2.5		%
		$ I_{OCDTH1} = 14.6\text{A}$		± 5.0		%
Overcurrent Detection Recovery Time 1 Note3)	t_{RCOCD1}	$R_{OCD} = 1\text{k}\Omega$ $C_{LOCD} = 1000\text{pF}$		3.3		μs
Overcurrent Detection Threshold 1 Hysteresis Note3)	I_{OCDHY1}			2		A

Table 7. Electrical Characteristics (Overcurrent detection function characteristics 2)

Conditions(unless otherwise specified) : $T_a=35^{\circ}\text{C}$, $V_{DD}=5\text{V}$

Parameter	Symbol	Conditions	Min.	Typ.	Max.	Units
Overcurrent Detection Output Voltage 2	V_{OCD2}	$R_{OCD}=1\text{k}\Omega$			$0.1 \times V_{OCDP}$	V
ON-Resistance at Overcurrent Detection Output 2	R_{SOCD2}			12		Ω
Overcurrent Detection Threshold 2 Adjustable Range Note7)	$ I_{OCDTH2} $		36.5		72.9	A
Overcurrent Detection Response Time 2 Note3)	t_{RSOCD2}	$R_{OCD} = 1\text{k}\Omega$ $C_{LOCD} = 1000\text{pF}$		2.5	3.7	μs
Overcurrent Detection Threshold 2 Adjustment Error Note3), Note8)	E_{OC2}	$ I_{OCDTH2} = 72.9\text{A}$		± 2.5		%
		$ I_{OCDTH2} = 36.5\text{A}$		± 5.0		%
Overcurrent Detection Recovery Time 2 Note3)	t_{RCOCD2}	$R_{OCD} = 1\text{k}\Omega$ $C_{LOCD} = 1000\text{pF}$		3.3		μs
Overcurrent Detection Threshold 2 Hysteresis Note3)	I_{OCDHY2}			2		A

Table 8. Temperature drift characteristics

Conditions(unless otherwise specified) : $V_{DD}=5V$

Parameter	Symbol	Conditions	Min.	Typ.	Max.	Units
Temperature Drift of Sensitivity Note 4) Note 8) Note 9)	V_{h-d}	$T_a=35\sim 85^\circ C$		± 0.6	± 0.8	%
		$T_a=-40\sim 35^\circ C$		± 2.7	± 3.0	
Temperature Drift of Zero-current Output Voltage Note 4) Note 8) Note 9)	V_{of-d}	$T_a=35\sim 85^\circ C$ $I_{IN}=0A$		± 0.9	± 2.7	mV
		$T_a=-40\sim 85^\circ C$ $I_{IN}=0A$		± 7.5	± 10.1	
Total Accuracy Note 4) Note 8)	E_{total}	$T_a=35\sim 85^\circ C$ F.S.= $V_{satH}-V_{satL}$		0.3	0.6	%F.S.
		$T_a=-40\sim 85^\circ C$ F.S.= $V_{satH}-V_{satL}$		1.8	2.1	

Note 1) These values can be drifted by long-term use or reflow process. Please see '14.Reliability Tests' for the reference of drift values.

Note 2) These parameters are guaranteed by design.

Note 3) These parameters are tested to input the equivalent current signal into IC in wafer condition. These characteristics after assembly are guaranteed by design.

Note 4) The typical value is defined as the "average value $\pm 1\sigma$ " of the actual measurement result in a certain lot. The minimum value and the maximum value are defined as "average value $\pm 3\sigma$ " of the same condition.

Note 5) The threshold level of the dV/dt settling time is the convergence value $\pm 2mV$.

Note 6) This parameter is tested for 1second at $3.6kV_{rms}$ in mass-production line for all devices.

Note 7) The usage beyond $T_j = 125^\circ C$ is prohibited.

Note 8) These values can be drifted by long-term use or reflow process.

Note 9) These parameters are defined as the drift from the values at $T_a=35^\circ C$.

10. Characteristic Definitions

10.1. Sensitivity(V_h), Zero-Current Output Voltage (V_{of}), and Linearity Error (ρ) are defined as below:

Sensitivity(V_h) is defined as the slope of the approximate straight line calculated by the least square method, using the data of output voltage (V_{OUT}) when the primary current (I_{IN}) is swept within the range of linear sensing range (I_{NS}).

The output voltage (V_{OUT}) when the primary current (I_{IN}) is 0A is the Zero-Current Output Voltage (V_{of}).

Linearity Error (ρ) is defined as the ratio of the maximum error voltage (V_d) to the full scale (F.S.), where V_d is the maximum difference between the output voltage (V_{OUT}) and the approximate straight line.

Definition formula is shown as below:

$$\rho = V_d / \text{F.S.} \times 100$$

Full scale (F.S.) is defined by $V_{\text{satHmin}} - V_{\text{satLmax}}$.

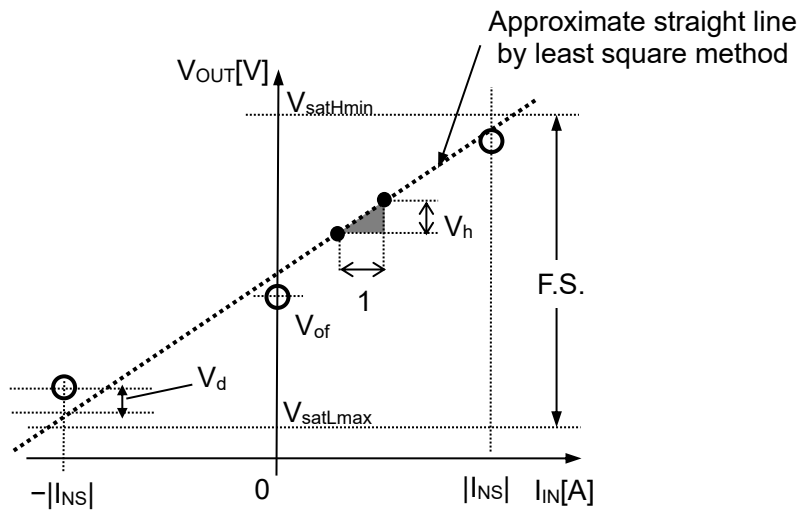

Figure 3. Characteristic definitions of CZ-3AG4

10.2. Total Accuracy E_{total} [%F.S.] is defined as below (See Figure 4.)

$$E_{total} = 100 \times \frac{V_{err}}{F.S.}$$

$$V_{err} = |V_{h-meas} - V_h| \times |I_{NS}| + |V_{of-d}| + |\rho_{meas}| \times F.S.$$

V_{h-meas} : Measured Sensitivity value [mV/A]

V_h : Sensitivity (Typ.) [mV/A]

V_{of-d} : Measured Temperature Drift of Zero-Current Output [mV]

ρ_{meas} : Measured Linearity Error [%F.S.]

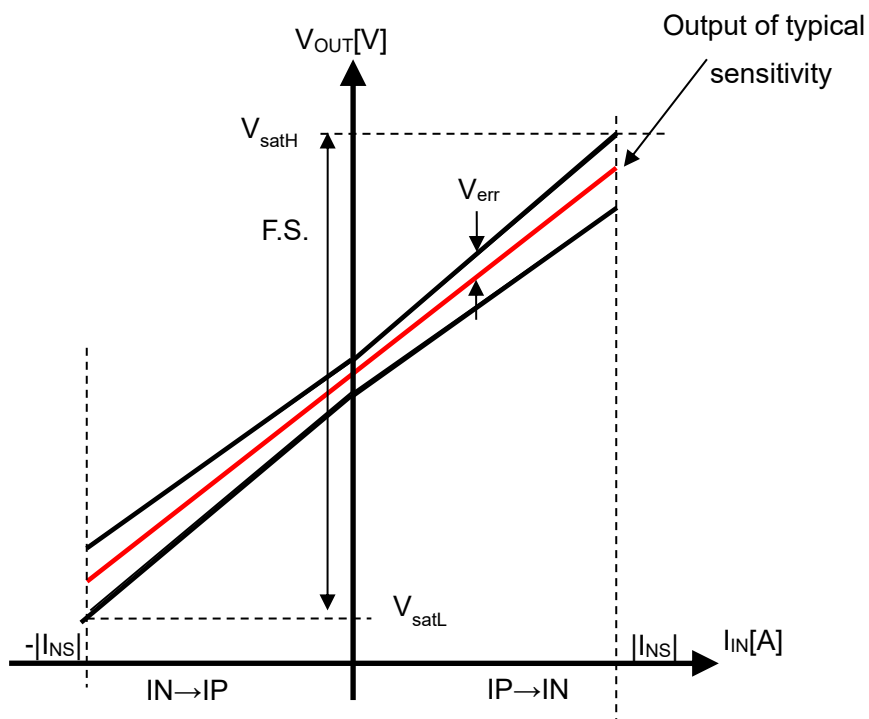

Figure 4. Total Accuracy of CZ-3AG4

10.3. Rise Response Time t_r [μs] and Fall Response Time t_f [μs]

Rise response time (or fall response time) is defined as the time delay from the 90% (or 10%) of input primary current (I_{IN}) to the 90% (or 10%) of the output voltage (V_{OUT}) under the pulse input of primary current (Figure 5).

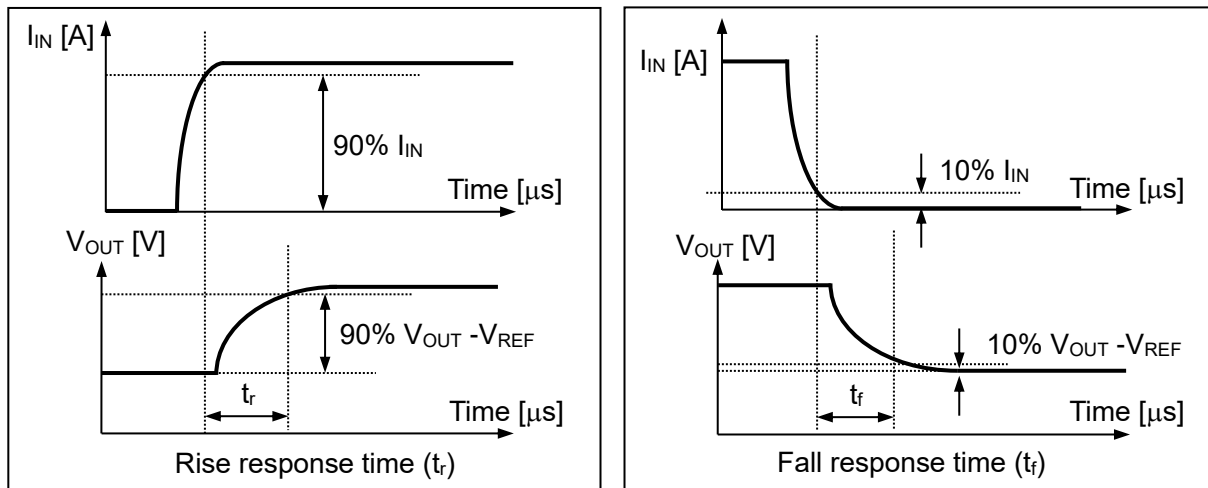

Figure 5. Definition of response time

10.4. Overcurrent Detection Function is operated as below. (See figure 6.)

- (1) After the $I_{IN}[A]$ has exceeded the overcurrent detection threshold (I_{OCDTH}) for overcurrent response time (t_{RSOCD}), overcurrent detection output voltage (V_{OCD}) will be logical low.
- (2) When the $I_{IN}[A]$ decreases below the value ($I_{OCDTH} - I_{OCDHY}$) which is defined by difference between the overcurrent detection threshold (I_{OCDTH}) and overcurrent detection threshold hysteresis (I_{OCDHY}), overcurrent detection output voltage (V_{OCD}) goes high within the overcurrent recovery time (t_{RCOCD}).
- (3) If the $I_{IN}[A]$ goes up more than the overcurrent detection threshold (I_{OCDTH}) and then decreases below the value ($I_{OCDTH} - I_{OCDHY}$) for less than overcurrent response time (t_{RSOCD}), the overcurrent detection output voltage (V_{OCD}) does not change.

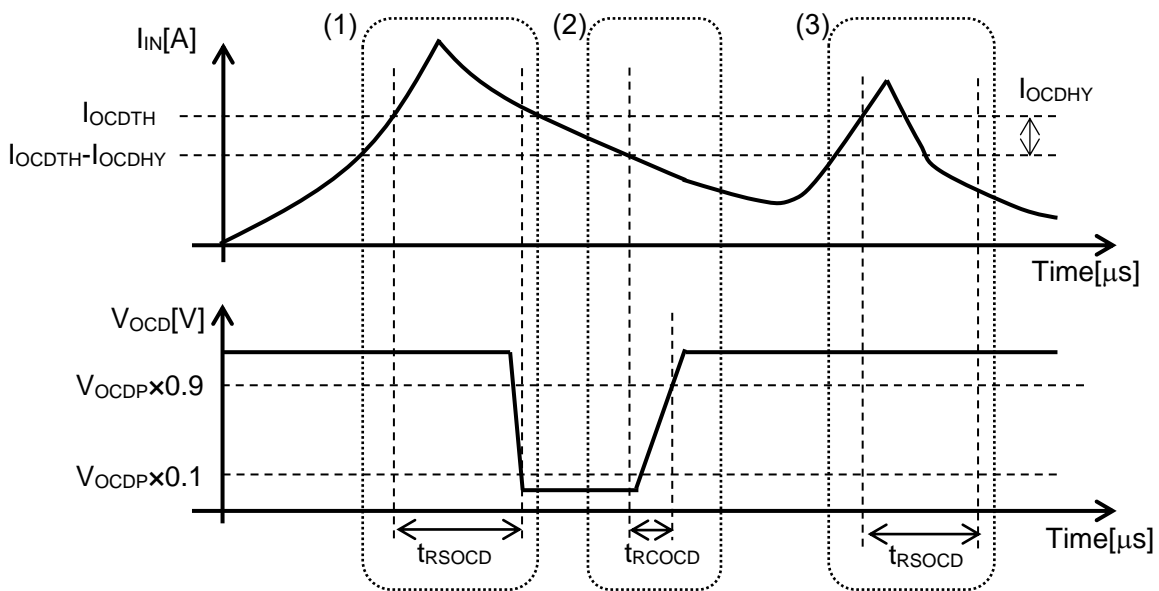

Figure 6. Overcurrent Detection Function of CZ-3AG4

10.5. Overcurrent Detection Threshold is decided as below.

V_{REF1} [mV] and V_{REF2} [mV] values for setting the overcurrent detection threshold are calculated as follows:

$$V_{REF1} \text{ [mV]} = 2500 - |I_{OCDTH1}| \text{ [A]} \times (2112/35)$$

$|I_{OCDTH1}|$ [A] can be set between 14.6 [A] and 36.4 [A]. Overcurrent function can work both plus and minus direction current.

$$V_{REF2} \text{ [mV]} = 2500 - |I_{OCDTH2}| \text{ [A]} \times (1056/35)$$

$|I_{OCDTH2}|$ [A] can be set between 36.5 [A] and 72.9 [A]. Overcurrent function can work both plus and minus direction current.

Overcurrent detection characteristics are not guaranteed when operated V_{REF1} [mV] value is less than 300[mV] or more than 1620[mV].

Overcurrent detection characteristics are not guaranteed when operated V_{REF2} [mV] value is less than 300[mV] or more than 1400[mV].

If overcurrent detection function is not required, connect VSS to both REF1 pin and OCD1 pin or both REF2 pin and OCD2 pin.

11. External Circuits Example

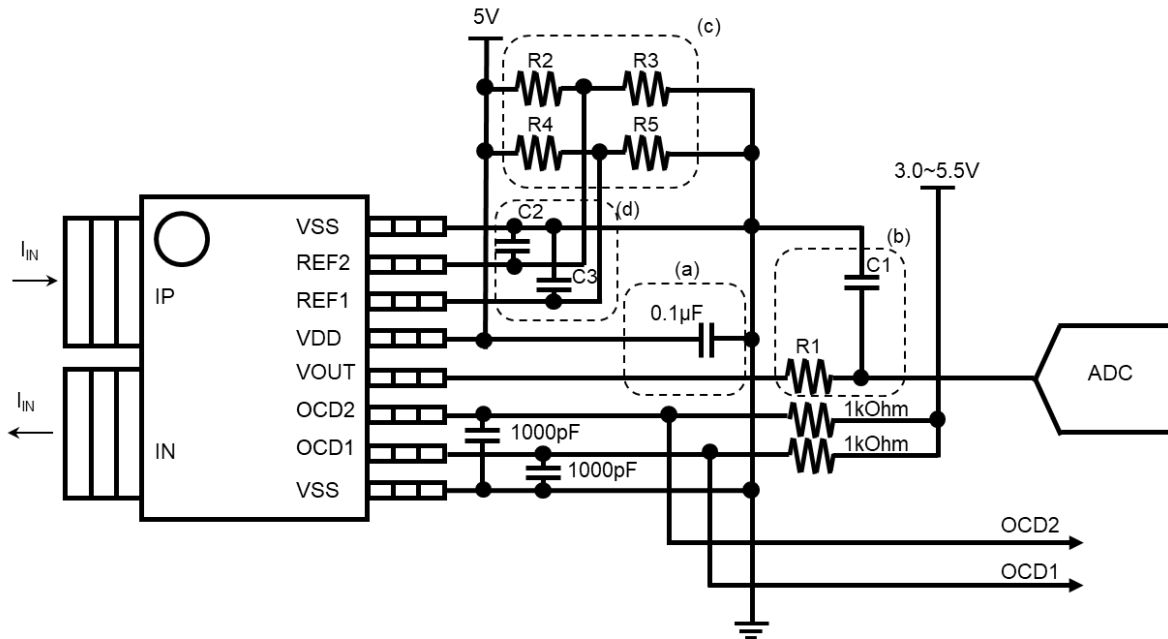

Figure 7. External circuits example

- (a) 0.1µF bypass capacitor should be placed close to CZ-3AG4.
- (b) Add a low-pass filter if it is necessary. The C1 values should be fixed in consideration of load conditions.
- (c) Overcurrent detection thresholds are decided by the input voltage of REF1 pin and REF2 pin. R2, R3, R4, and R5 values are determined according to the overcurrent detection thresholds. (See chapter 10.5)
- (d) Add capacitors if necessary. The C2 and C3 values should be fixed in consideration of the time constant values which are decided by ratio of C2 to R2 and R3 or C3 to R4 and R5.

12. Board Layout for Measuring Thermal Resistance

Table 9. Board information

Board Size	68.58mm×63.5mm
Layer number	4
Copper layer thickness	70μm
Board Thickness	1.6mm

• Top pattern(1st)

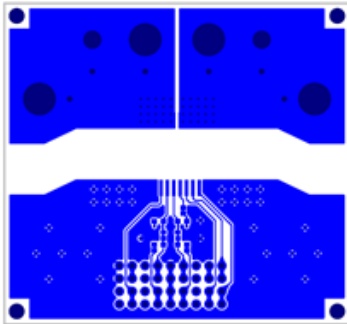

• Inner pattern(2nd/3rd VSS)

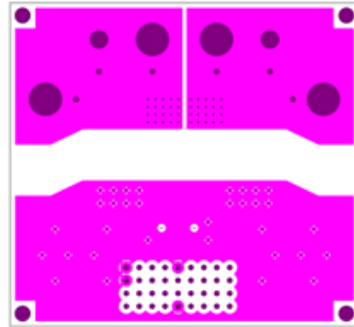

• Bottom pattern(4th)

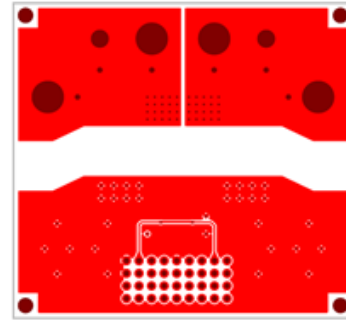
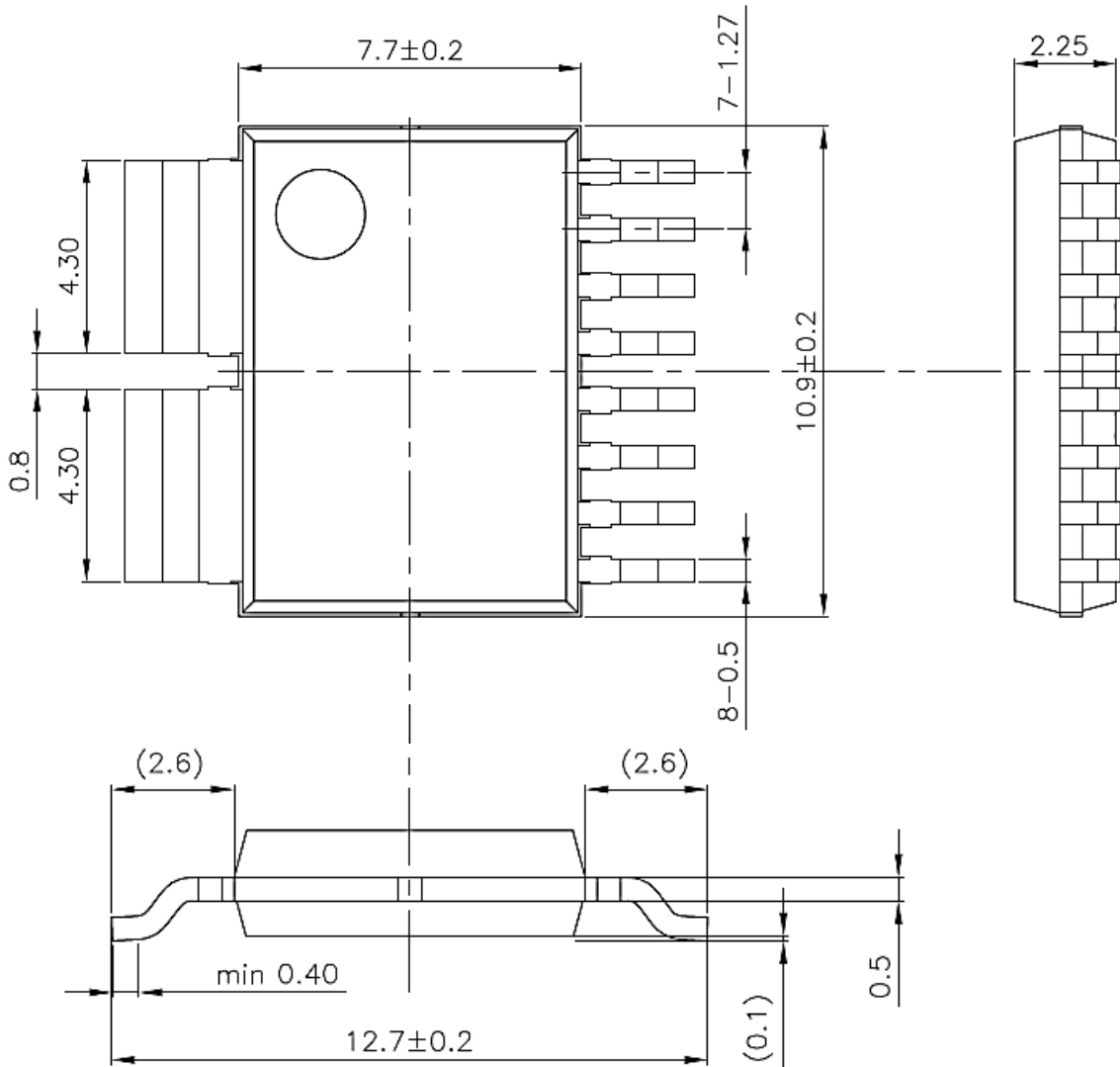

Figure 8. Board layout for measuring thermal resistance of CZ-3AG4

13. Package

13.1. Outline Dimensions



Unit : mm

The tolerances of dimensions without any mention are ± 0.1 mm.

() is a reference values.

Figure 9. Outline dimensions of CZ-3AG4

Terminals : Cu

Plating for Terminals : Sn-Bi

Package material : RoHS compliant, halogen-free

Table 10. Isolation characteristics of CZ-3AG4

Parameter	Symbol	Min.	Typ.	Max.	Units
Creepage distance	Cr	8.0			mm
Clearance distance	Cl	8.0			mm

*Flammability standard is V0. (According to UL94)

*Comparative tracking index (CTI) is 400V. Material Group is II.

13.2. Standards

- IEC/UL 62368-1 Audio/video, information and communication technology equipment Part 1: Safety requirements Edition 2. (File No. E359197)
- CSA C22.2 No.62368-1-14 Audio/video, information and communication technology equipment Part 1: Safety requirements Edition 2. (File No. E359197)
- UL1577 Non-Optical Isolators-Edition 5.(File No. E499004)
- CSA Component Acceptance Service No. 5A - Component Acceptance Service for Optocouplers and Related Devices (File No. E499004)

13.3. Recommended Pad Dimensions

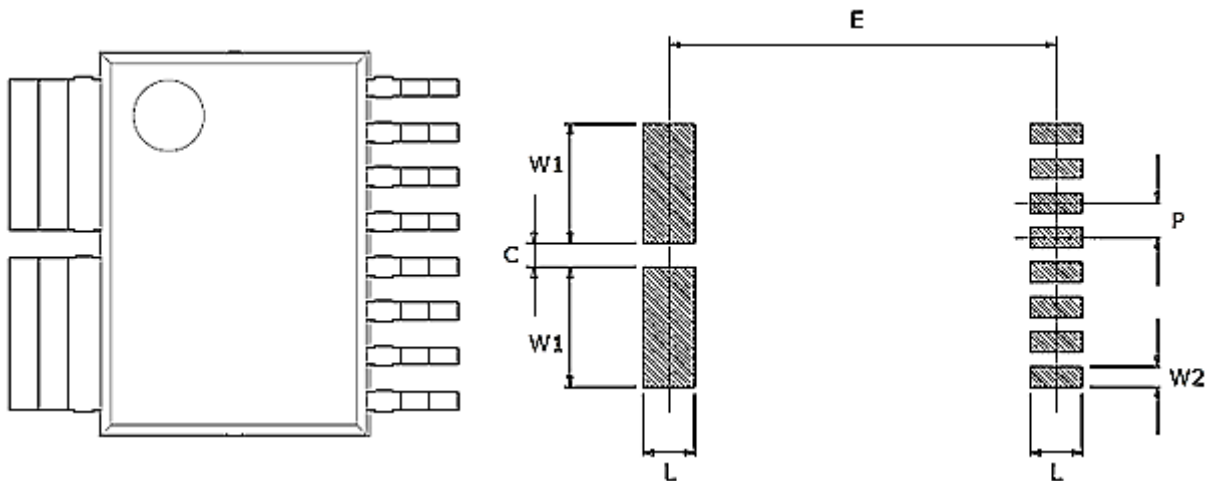

Figure 10. Recommended pad pattern

Table 11. Recommended pad dimensions

L	1.59
E	11.79
W1	4.44
W2	0.64
C	0.66
P	1.27

Unit:mm

If two or more trace layers are used as the current paths, please make enough number of through-holes to flow current between the trace layers. In order to make heat dissipation better, it is recommended that Pad on Via should be provided on the pad of the primary conductor.

13.4. Marking

Production information is printed on the package surface by laser marking. Markings consist of 11 characters excluding AKM logo.

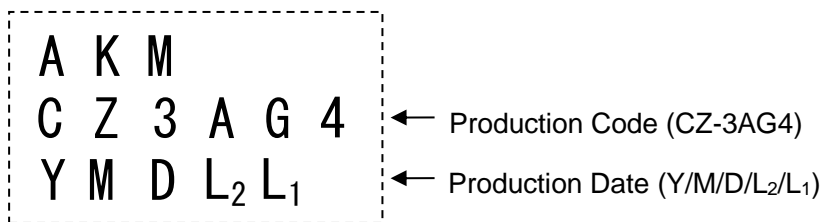

Figure 11. Markings of CZ-3AG4

Table 12. Production date code table

Year(Y)		Month(M)		Day(D)		Lot number		
Character	Year	Character	Month	Character	Day	Character (L ₂)	Character (L ₁)	Lot number
7	2017	C	January	1	1	0	1	01
8	2018	D	February	2	2	0	2	02
9	2019	E	March	3	3	0	3	03
A	2020	F	April	4	4	0	4	04
B	2021	G	May	5	5	0	5	05
C	2022	H	June	6	6	⋮	⋮	⋮
D	2023	J	July	7	7			
E	2024	K	August	8	8	6	7	67
F	2025	L	September	9	9	6	8	68
G	2026	M	October	0	10	6	9	69
H	2027	N	November	A	11	7	0	70
J	2028	P	December	B	12	7	1	71
K	2029			C	13	⋮	⋮	⋮
L	2030			D	14			
N	2031			E	15			
P	2032			F	16			
R	2033			G	17			
S	2034			H	18			
T	2035			J	19			
U	2036			K	20			
V	2037			L	21			
W	2038			N	22			
X	2039			P	23			
0	2040			R	24			
1	2041			S	25			
2	2042			T	26			
3	2043			U	27			
4	2044			V	28			
				W	29			
				X	30			
				Y	31			

14. Reliability Tests

Table 13. Test parameters and conditions of reliability tests

No.	Test Parameter	Test Conditions	n	Test Time
1	Temperature Humidity Bias Test	【JEITA EIAJ ED-4701 102】 T _a =85°C, 85%RH, continuous operation	22	500h
2	High Temperature Bias Test	【JEITA EIAJ ED-4701 101】 T _a =150°C, continuous operation	22	500h
3	High Temperature Storage Test	【JEITA EIAJ ED-4701 201】 T _a =150°C	22	500h
4	Low Temperature Operating Test	T _a =-40°C, continuous operation	22	500h
5	Temperature Cycle Test	【JEITA EIAJ ED-4701 105】 -65°C ⇄ +150°C 30min. ⇄ 30min. Tested in vapor phase	22	200 Cycles

Tested samples are pretreated as below before each reliability test:
 Desiccation: 125°C/24h → Moisture Absorption: 60°C/60%RH/168h
 → Reflow: 3 times (JEDEC Level2a)

Criteria :

Products whose drifts between before pretreated and after the reliability tests do not exceed the values below are considered to be in spec.

Sensitivity V _h (T _a =25°C)	: Within ±1.5%
Zero-Current Output Voltage V _{of} (T _a =25°C)	: Within ±15mV
Linearity Error ρ (T _a =25°C)	: Within ±1.0%F.S.
EEPROM data	: Unchanged

15. Precautions

<Storage Environment>

Products should be stored at an appropriate temperature and humidity (5 to 35°C, 40 to 85%RH). It is recommended to use the products within 4 weeks since packing was opened. Keep products away from chlorine and corrosive gas. When stored in an inappropriate environment, it can affect the product properties.

<Long-term Storage>

Long-term storage may result in poor lead solderability and degraded electrical performance even under proper conditions. For those parts, which stored long-term should be checked as for solderability before it is used.

For storage longer than 1 year, it is recommended to store in nitrogen atmosphere. Oxygen of atmosphere oxidizes leads of products, and lead solderability get worse.

<Other Precautions>

- 1) This product should not be used under the environment with corrosive gas including chlorine or sulfur.
- 2) This product is lead (Pb) free. All leads are plated with Sn-Bi. Do not store this product alone in high temperature and high humidity environment. Moreover, this product should be mounted on substrate within six months after delivery.
- 3) This product is damaged when it is used on the following conditions:
 - Supply voltage is applied in the opposite way.
 - Overvoltage which is larger than the value indicated in the specification.
- 4) This product will be damaged if it is used for a long time with the current (effective current) which exceeds the current rating. Careful attention must be paid so that maximum effective current is smaller than current rating.
- 5) The characteristics can be changed by the influences of nearby current and magnetic field and electric field. Please make sure of the mounting position.

As this product contains gallium arsenide, observe the following procedures for safety.

- 1) Do not alter the form of this product into a gas, powder, liquid, through burning, crushing, or chemical processing.
- 2) Observe laws and company regulations when discarding this product.

16. Revision History

Date (Y/M/D)	Revision	Reason	Page	Contents
18/09	00	First Edition	21	
21/11/11	01	Second Edition	22	Transferring the front-end process



IMPORTANT NOTICE

0. Asahi Kasei Microdevices Corporation ("AKM") reserves the right to make changes to the information contained in this document without notice. When you consider any use or application of AKM product stipulated in this document ("Product"), please make inquiries the sales office of AKM or authorized distributors as to current status of the Products.
1. All information included in this document are provided only to illustrate the operation and application examples of AKM Products. AKM neither makes warranties or representations with respect to the accuracy or completeness of the information contained in this document nor grants any license to any intellectual property rights or any other rights of AKM or any third party with respect to the information in this document. You are fully responsible for use of such information contained in this document in your product design or applications. **AKM ASSUMES NO LIABILITY FOR ANY LOSSES INCURRED BY YOU OR THIRD PARTIES ARISING FROM THE USE OF SUCH INFORMATION IN YOUR PRODUCT DESIGN OR APPLICATIONS.**
2. The Product is neither intended nor warranted for use in equipment or systems that require extraordinarily high levels of quality and/or reliability and/or a malfunction or failure of which may cause loss of human life, bodily injury, serious property damage or serious public impact, including but not limited to, equipment used in nuclear facilities, equipment used in the aerospace industry, medical equipment, equipment used for automobiles, trains, ships and other transportation, traffic signaling equipment, equipment used to control combustions or explosions, safety devices, elevators and escalators, devices related to electric power, and equipment used in finance-related fields. Do not use Product for the above use unless specifically agreed by AKM in writing.
3. Though AKM works continually to improve the Product's quality and reliability, you are responsible for complying with safety standards and for providing adequate designs and safeguards for your hardware, software and systems which minimize risk and avoid situations in which a malfunction or failure of the Product could cause loss of human life, bodily injury or damage to property, including data loss or corruption.
4. Do not use or otherwise make available the Product or related technology or any information contained in this document for any military purposes, including without limitation, for the design, development, use, stockpiling or manufacturing of nuclear, chemical, or biological weapons or missile technology products (mass destruction weapons). When exporting the Products or related technology or any information contained in this document, you should comply with the applicable export control laws and regulations and follow the procedures required by such laws and regulations. The Products and related technology may not be used for or incorporated into any products or systems whose manufacture, use, or sale is prohibited under any applicable domestic or foreign laws or regulations.
5. Please contact AKM sales representative for details as to environmental matters such as the RoHS compatibility of the Product. Please use the Product in compliance with all applicable laws and regulations that regulate the inclusion or use of controlled substances, including without limitation, the EU RoHS Directive. AKM assumes no liability for damages or losses occurring as a result of noncompliance with applicable laws and regulations.
6. Resale of the Product with provisions different from the statement and/or technical features set forth in this document shall immediately void any warranty granted by AKM for the Product and shall not create or extend in any manner whatsoever, any liability of AKM.
7. This document may not be reproduced or duplicated, in any form, in whole or in part, without prior written consent of AKM.







Rev.1

Looking for pricing, stock, or lifecycle information?

Click below to explore more details on WIN SOURCE:

-  [View CZ3AG4 on WIN SOURCE](#)
-  [Asahi Kasei Microsystems Information](#)

Optimize Your Supply Chain with WIN SOURCE Solutions

-  Global Sourcing Solution
-  Obsolete Management
-  Cost Control Management
-  Shortage Management
-  Alternative Solution
-  Excess Inventory Management