

450 kHz, High Accuracy Current Sensor With FAULT or Reference Output

FEATURES AND BENEFITS

- High operating bandwidth and fast response time
 - 450 kHz bandwidth
 - 1.3 μ s response time
- High-accuracy current measurements
 - $\pm 1.5\%$ sensitivity error over temperature
 - ± 4 mV offset voltage over temperature
 - Nonratiometric operation with VREF output for enhanced accuracy in noisy environments
 - Differential sensing robust against external magnetic fields
 - Magnetic hysteresis-free operation
- Wide operating temperature, -40°C to 150°C
- Low internal primary conductor resistance (0.68 m Ω) for better power efficiency (low dissipation)
- Highly isolated compact surface-mount packages
- AEC-Q100 Grade 0, automotive qualified

PACKAGE

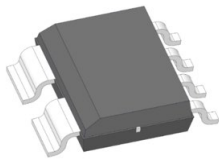

6-Pin Fused-Lead SOIC
(suffix LZ)

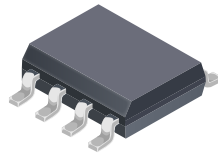

8-Pin SOIC
(suffix LC)

Not to scale

DESCRIPTION

The ACS37010 and ACS37012 are fully integrated current sensor ICs that sense current flowing through the compact LZ and LC packages. The low-resistance conductor is ideal for low power dissipation constraints. The sensor is factory-trimmed to provide high accuracy over the entire operating range without the need for customer programming.

The internal construction provides high isolation and excellent magnetic coupling of the field generated by the current flowing in the conductor and the fully monolithic Hall sensor IC. The current is sensed differentially by two Hall plates that subtract interfering common-mode magnetic fields. The sensor provides a very fast 1.3 μ s response time analog output with VREF pin for use in noisy supply environments (ACS37010) or a fast logic alert fault output pin with factory pre-programmed trip point provides overcurrent or short-circuit detection and enhanced system protection (ACS37012). The IC has no physical connection to the integrated current conductor and provides high isolation (withstand strength of 3500 V_{RMS} for the LZ package and 2400 V_{RMS} for the LC package) between the primary and secondary signal leads of the package.

The ACS37010/12 is offered in a custom 6-pin SOIC package (suffix LZ) and a standard 8-pin SOIC package. Devices are RoHS-compliant and lead (Pb) free without the use of RoHS exemptions with 100% matte-tin-plated leadframes.

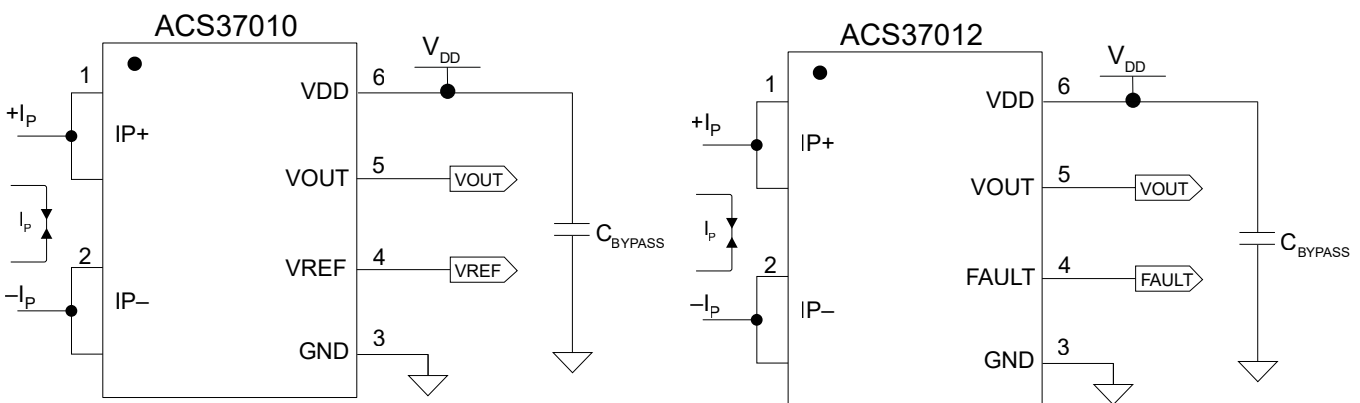

Figure 1: Typical Application Circuit

The device outputs an analog signal, V_{OUT} , that varies linearly with the AC or DC primary current, I_p , within the ranges specified.

TABLE OF CONTENTS

Features and Benefits	1	ACS37010LLCTR-010B3 Performance Characteristics	19
Description	1	ACS37010LLCTR-050B5 Performance Characteristics	20
Package	1	ACS37010LLCTR-050B3 Performance Characteristics	21
Typical Application Circuit	1	ACS37012LLCTR-010B5 Performance Characteristics	22
Selection Guide	3	ACS37012LLCTR-010B3 Performance Characteristics	23
Part Naming Specification	3	ACS37012LLCTR-050B5 Performance Characteristics	24
Absolute Maximum Ratings	4	ACS37012LLCTR-050B3 Performance Characteristics	25
LZ Isolation Characteristics	4	Characteristic Performance	26
LC Isolation Characteristics	4	ACS37010 and ACS37012 Typical Frequency Response	26
Package Characteristics	5	Response Characteristics Definitions and Typical Performance Data	27
Pinout Diagram and Terminal List Table	5	Functional Description of Power On/Off Operation	28
Functional Block Diagram	6	Introduction	28
Common Electrical Characteristics	7	Voltage Thresholds	28
ACS37010LLZATR-030B5 Performance Characteristics	9	Timing Thresholds	31
ACS37010LLZATR-030U5 Performance Characteristics	10	Definitions of Operating and Performance Characteristics	32
ACS37010LLZATR-030B3 Performance Characteristics	11	Overcurrent Fault (OCF) Behavior	33
ACS37010LLZATR-050B5 Performance Characteristics	12	Thermal Performance	34
ACS37010LLZATR-050B3 Performance Characteristics	13	Thermal Rise vs. Primary Current	34
ACS37012LLZATR-030B5 Performance Characteristics	14	Safe Operating Region	36
ACS37012LLZATR-030B3 Performance Characteristics	15	Evaluation Board Layout	36
ACS37012LLZATR-050B5 Performance Characteristics	16	Package Outline Drawing	37
ACS37012LLZATR-050B3 Performance Characteristics	17	Revision History	39
ACS37010LLCTR-010B5 Performance Characteristics	18		

ACS37010 and ACS37012

450 kHz, High Accuracy Current Sensor With FAULT or Reference Output

SELECTION GUIDE

Part Number	Current Sensing Range, I_{PR} (A)	Sensitivity (mV/A)	V_{DD} (V)	V_{QVO} (V)	Feature	Optimized Temperature Range T_A (°C)	Packing		
LZ PACKAGE, 6-PIN FUSED-LEAD SOIC									
ACS37010LLZATR-030B5	±30	66.7	5	2.5	VREF	-40 to 150	Tape and Reel, 3000 pieces per reel		
ACS37010LLZATR-030U5	30	133.3	5	0.5					
ACS37010LLZATR-030B3	±30	44	3.3	1.65					
ACS37010LLZATR-050B5	±50	40	5	2.5					
ACS37010LLZATR-050B3	±50	26.4	3.3	1.65					
ACS37012LLZATR-030B5	±30	66.7	5	2.5	FAULT			-40 to 150	Tape and Reel, 3000 pieces per reel
ACS37012LLZATR-030B3	±30	44	3.3	1.65					
ACS37012LLZATR-050B5	±50	40	5	2.5					
ACS37012LLZATR-050B3	±50	26.4	3.3	1.65					
ACS37012LLZATR-050B3	±50	26.4	3.3	1.65					
LC PACKAGE, 8-PIN SOIC									
ACS37010LLCTR-010B5	±10	200	5	2.5	VREF	-40 to 150	Tape and Reel, 3000 pieces per reel		
ACS37010LLCTR-010B3	±10	132	3.3	1.65					
ACS37010LLCTR-050B5	±50	40	5	2.5					
ACS37010LLCTR-050B3	±50	26.4	3.3	1.65					
ACS37012LLCTR-010B5	±10	200	5	2.5	FAULT			-40 to 150	Tape and Reel, 3000 pieces per reel
ACS37012LLCTR-010B3	±10	132	3.3	1.65					
ACS37012LLCTR-050B5	±50	40	5	2.5					
ACS37012LLCTR-050B3	±50	26.4	3.3	1.65					

PART NAMING SPECIFICATION

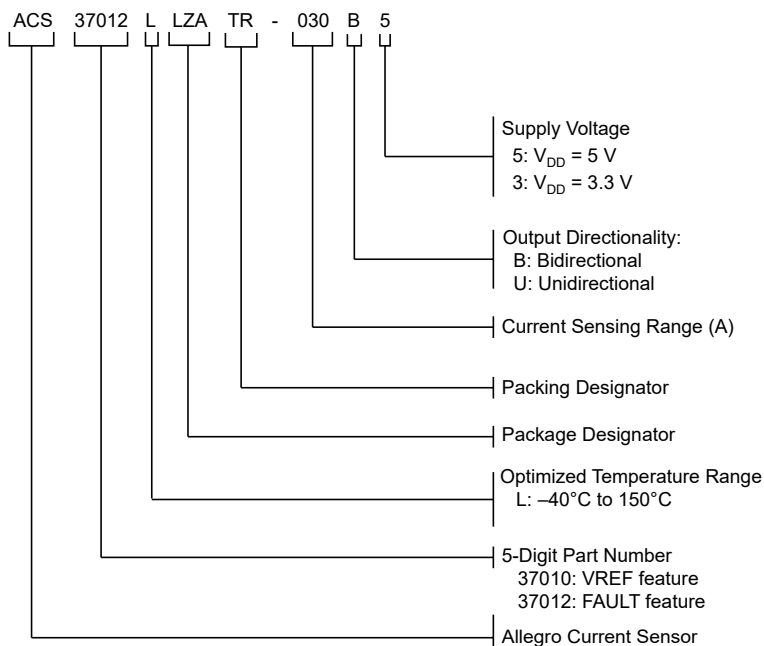

ACS37010 and ACS37012

450 kHz, High Accuracy Current Sensor With FAULT or Reference Output

ABSOLUTE MAXIMUM RATINGS [1]

Characteristic	Symbol	Notes	Min.	Max.	Unit
Supply Voltage	V_{DD}		-0.5	6.5	V
Output Voltage	V_O	Applies to V_{OUT} , V_{REF} or V_{FAULT}	-0.5	$(V_{DD} + 0.7) \leq 6.5$	V
Operating Ambient Temperature	T_A		-40	150	°C
Storage Temperature	T_{STG}		-65	165	°C
Maximum Junction Temperature	$T_{J(MAX)}$	Sensing range of sensor is limited by $T_{J(MAX)} = 165^\circ\text{C}$	-	165	°C

[1] A stress that exceeds the absolute maximum rating listed might cause permanent damage to the device. This is a stress rating only; functional operation of the device at these or any other condition that exceeds those indicated in the operational sections of this specification is not implied. Exposure to absolute maximum ratings for extended periods might affect device reliability.

LZ ISOLATION CHARACTERISTICS

Characteristic	Symbol	Notes	Value	Units
Withstand Strength [1][2]	V_{ISO}	Agency rated for 60 seconds per UL 62368-1 (edition 3)	3500	V_{RMS}
Working Voltage for Basic Isolation [2]	V_{WVBI}	Maximum approved working voltage for basic (single) isolation according to UL 62368-1 (edition 3)	1188	V_{PK} or V_{DC}
			840	V_{RMS}
Working Voltage for Reinforced Isolation [2]	V_{WVRI}	Maximum approved working voltage for reinforced isolation according to UL 62368-1 (edition 3)	594	V_{PK} or V_{DC}
			420	V_{RMS}
Surge Voltage	V_{SURGE}	1.2/50 μs waveform, tested in dielectric fluid to determine the intrinsic surge immunity of the isolation barrier	13000	V_{PK}
Impulse Withstand	$V_{IMPULSE}$	1.2/50 μs waveform, tested in air	5000	V_{RMS}
Clearance	D_{CL}	Minimum distance through air from IP leads to signal leads	4.1	mm
Creepage	D_{CR}	Minimum distance along package body from IP leads to signal leads	4.1	mm
Distance Through Insulation	DTI	Minimum internal distance through insulation	54	μm
Comparative Tracking Index	CTI	Material Group I	>600	V

[1] Production tested in accordance UL 62368-1 (edition 3).

[2] Certification pending.

LC ISOLATION CHARACTERISTICS

Characteristic	Symbol	Notes	Rating	Unit
Withstand Strength [1][2]	V_{ISO}	Agency rated for 60 seconds per UL 62368-1 (edition 3), < 125°C	2400	V_{RMS}
		Agency rated for 60 seconds per UL 62368-1 (edition 3), > 125°C	1768	V_{RMS}
Working Voltage for Basic Isolation [2]	V_{WVBI}	Maximum approved working voltage for basic (single) isolation according to UL 62368-1 (edition 3)	420	V_{PK} or V_{DC}
			297	V_{RMS}
Surge Voltage	V_{SURGE}	1.2/50 μs waveform, tested in dielectric fluid to determine the intrinsic surge immunity of the isolation barrier	5000	V_{PK}
Impulse Withstand	$V_{IMPULSE}$	1.2/50 μs waveform, tested in air	4000	V_{PK}
Clearance	D_{CL}	Minimum distance through air from IP leads to signal leads	4	mm
Creepage	D_{CR}	Minimum distance along package body from IP leads to signal leads	4	mm
Distance Through Insulation	DTI	Minimum internal distance through insulation	44	μm
Comparative Tracking Index	CTI	Material Group II	400 to 599	V

[1] Production tested in accordance UL 62368-1 (edition 3).

[2] Certification pending.

ACS37010 and ACS37012

450 kHz, High Accuracy Current Sensor With FAULT or Reference Output

PACKAGE CHARACTERISTICS

Characteristic	Symbol	Notes	Min.	Typ.	Max.	Unit	
Primary Conductor Resistance	R_{IP}	$T_A = 25^\circ\text{C}$	LZ package	–	0.68	–	m Ω
			LC package	–	0.9	–	m Ω
Primary Conductor Inductance	L_{IP}	$T_A = 25^\circ\text{C}$	LZ package	–	2.4	–	nH
			LC package	–	2	–	nH
Moisture Sensitivity Level	MSL	Per IPC/JEDEC J-STD-020	–	2	–	–	

PINOUT DIAGRAM AND TERMINAL LIST TABLE

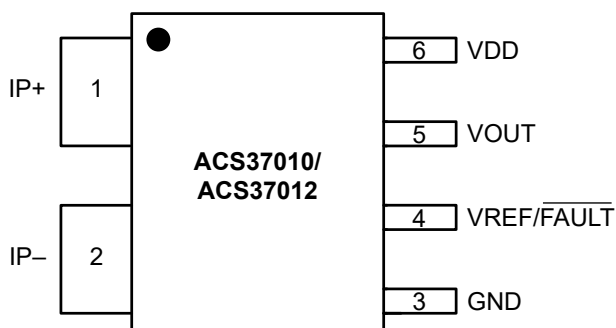

Pinout Diagram
Package LZ, 6-Pin SOIC

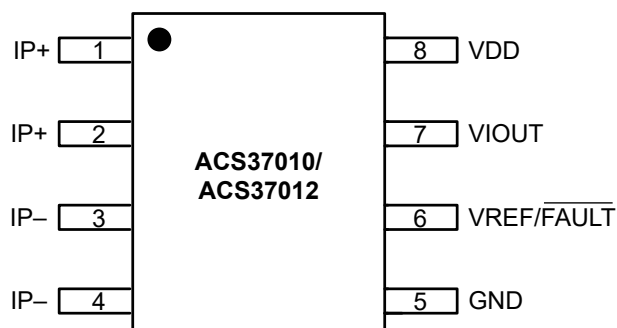

Pinout Diagram
Package LC, 8-Pin SOIC

Terminal List Table

Number	Name	Description
1	IP+	Terminal for current being sensed
2	IP–	Terminal for current being sensed
3	GND	Device ground terminal
4	VREF/ FAULT	Zero-current voltage reference (ACS37010) or overcurrent fault output (ACS37012)
5	VOUT	Analog output
6	VDD	Device power supply terminal

Terminal List Table

Number	Name	Description
1,2	IP+	Positive terminals for current being sensed; fused internally
3,4	IP–	Negative terminals for current being sensed; fused internally
5	GND	Device ground terminal
6	VREF/ FAULT	Zero current-voltage reference (ACS37010) or overcurrent fault output (ACS37012)
7	VOUT	Analog output
8	VDD	Device power supply terminal

FUNCTIONAL BLOCK DIAGRAM

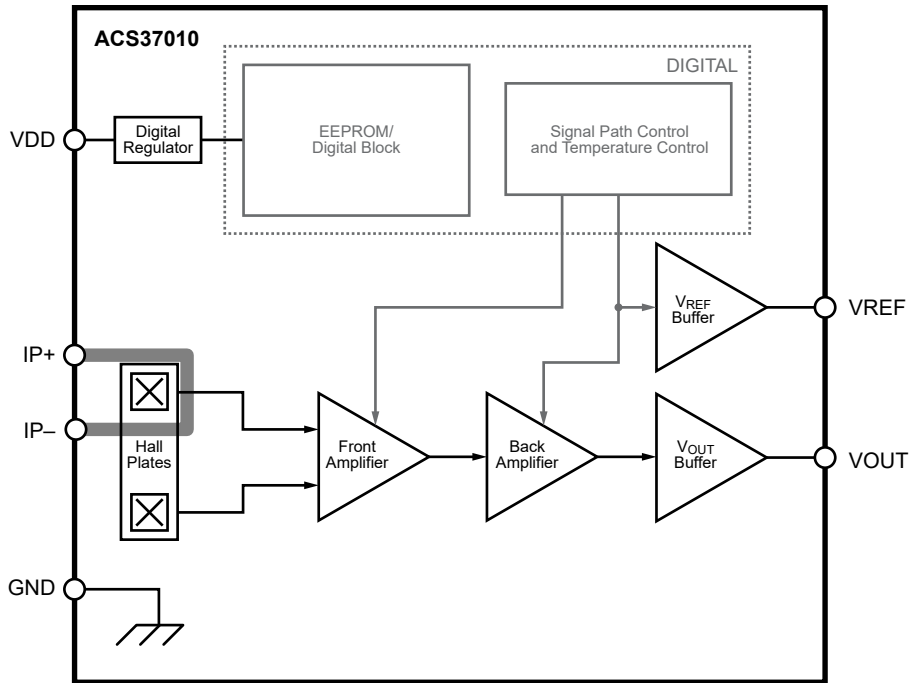

Figure 2: ACS37010 Functional Block Diagram

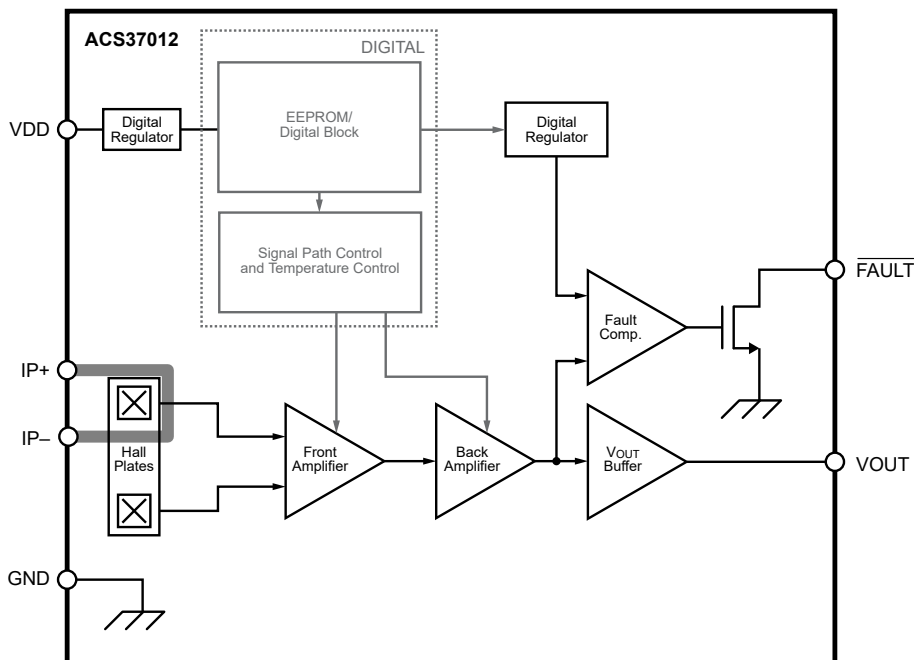

Figure 3: ACS37012 Functional Block Diagram

ACS37010 and ACS37012

450 kHz, High Accuracy Current Sensor With FAULT or Reference Output

COMMON ELECTRICAL CHARACTERISTICS: Valid over full operating temperature range, $T_A = -40^\circ\text{C}$ to 150°C , $C_{\text{BYPASS}} = 100\text{ nF}$, and $V_{\text{DD}} = 5\text{ V}$ or 3.3 V , unless otherwise specified

Characteristics	Symbol	Test Conditions	Min.	Typ.	Max.	Unit
Supply Voltage	V_{DD}	5 V variant	4.5	5	5.5	V
		3.3 V variant	3	3.3	3.6	V
Supply Current	I_{DD}	5 V variant, no load on VOUT or VREF	–	16	20	mA
		3.3 V variant, no load on VOUT or VREF	–	14	18	mA
Output Resistive Load	$R_{\text{L_VOUT}}$		10	–	–	k Ω
Output Capacitive Load [1]	$C_{\text{L_VOUT}}$		–	–	6	nF
Supply Bypass Capacitor	C_{BYPASS}		0.1	1	–	μF
Power-On Reset Release Voltage	V_{POR}	V_{DD} rising 1 V/ms	2.7	2.9	3	V
Power-On Reset Hysteresis	$V_{\text{POR_HYS}}$		250	300	500	mV
Power-On Time	t_{PO}	$T_A = 25^\circ\text{C}$	–	65	–	μs
Undervoltage Detection Threshold [2]	V_{UVD}	$T_A = 25^\circ\text{C}$, V_{DD} falling 1 V/ms	3.8	4.1	4.25	V
Undervoltage Detection Hysteresis [2]	$V_{\text{UVD_HYS}}$		200	250	400	mV
Undervoltage Detection Time [2]	t_{UVD}		–	70	200	μs
Undervoltage Detection Release Time [2]	$t_{\text{UVD_R}}$		–	6	–	μs
Overvoltage Detection Threshold	V_{OVD}	V_{DD} rising 1 V/ms	6.1	6.3	6.5	V
Overvoltage Detection Hysteresis	$V_{\text{OVD_HYS}}$	$T_A = 25^\circ\text{C}$	400	500	600	mV
Overvoltage Detection Time	t_{OVD}		–	70	200	μs
Overvoltage Detection Release Time	$t_{\text{OVD_R}}$		–	3	–	μs
OUTPUT SIGNAL CHARACTERISTICS (VOUT)						
Rise Time	t_{R}	$T_A = 25^\circ\text{C}$, $C_{\text{L_VOUT}} = 6\text{ nF}$, $C_{\text{BYPASS}} = 1\text{ }\mu\text{F}$	–	1	2.5	μs
Response Time	t_{RESP}	$T_A = 25^\circ\text{C}$, $C_{\text{L_VOUT}} = 6\text{ nF}$, $C_{\text{BYPASS}} = 1\text{ }\mu\text{F}$	–	1.3	2.5	μs
Propagation Delay	t_{PD}	$T_A = 25^\circ\text{C}$, $C_{\text{L_VOUT}} = 6\text{ nF}$, $C_{\text{BYPASS}} = 1\text{ }\mu\text{F}$	–	0.7	1.5	μs
Bandwidth	BW	$T_A = 25^\circ\text{C}$, Small Signal –3 dB, $C_{\text{L_VOUT}} = 6\text{ nF}$, $C_{\text{BYPASS}} = 1\text{ }\mu\text{F}$	–	450	–	kHz
Noise Density	N_{D}	$T_A = 25^\circ\text{C}$, $C_{\text{L_VOUT}} = 6\text{ nF}$, $C_{\text{BYPASS}} = 1\text{ }\mu\text{F}$, 5 V variant	–	150	–	$\mu\text{A}/\sqrt{\text{Hz}}$
		$T_A = 25^\circ\text{C}$, $C_{\text{L_VOUT}} = 6\text{ nF}$, $C_{\text{BYPASS}} = 1\text{ }\mu\text{F}$, 3.3 V variant	–	230	–	$\mu\text{A}/\sqrt{\text{Hz}}$
Output Saturation Voltage [3]	$V_{\text{SAT_H}}$	$R_{\text{L_VOUT}} = 10\text{ k}\Omega$ to GND	$V_{\text{DD}} - 0.25$	–	–	V
	$V_{\text{SAT_L}}$	$R_{\text{L_VOUT}} = 10\text{ k}\Omega$ to VDD	–	–	0.15	V
Short-Circuit Current	$I_{\text{SC_VOUT}}$	$T_A = 25^\circ\text{C}$, VOUT shorted to GND	–	25	–	mA
		$T_A = 25^\circ\text{C}$, VOUT shorted to VDD	–	–25	–	mA
Common Mode Field Sensitivity	CMFS		–	4	–	mA/G

Continued on next page...

COMMON ELECTRICAL CHARACTERISTICS (continued): Valid over full operating temperature range,
 $T_A = -40^\circ\text{C}$ to 150°C , $C_{\text{BYPASS}} = 100\text{ nF}$, and $V_{\text{DD}} = 5\text{ V}$ or 3.3 V , unless otherwise specified

Characteristics	Symbol	Test Conditions	Min.	Typ.	Max.	Unit
REFERENCE OUTPUT CHARACTERISTICS (VREF)^[4]						
VREF Resistive Load	R_{L_VREF}	VREF to GND or VREF to VDD	10	–	–	k Ω
VREF Capacitive Load	C_{L_VREF}	VREF to GND	–	1	6	nF
VREF Short-Circuit Current	I_{SC_VREF}	VREF shorted to GND	–	25	–	mA
		VREF shorted to VDD	–	–25	–	mA
OVERCURRENT CHARACTERISTICS (FAULT)^[5]						
Overcurrent Operating Point	I_{OC}	Internally set as a percent of full-scale current	–	100	–	% I_{PR}
FAULT Pull-Up Resistance	R_{L_FAULT}	FAULT to VDD	4.7	–	500	k Ω
Overcurrent Error	E_{OC}		–10	–	10	% I_{OC} ^[6]
FAULT Output Low Voltage	V_{FAULT_L}	$R_{L_FAULT} = 10\text{ k}\Omega$, fault condition present	–	–	0.4	V
FAULT Leakage Current	I_{FAULT_OFF}	$R_{L_FAULT} = 10\text{ k}\Omega$, no fault condition present	–	100	500	nA
Overcurrent Hysteresis	I_{OC_HYS}		–	9.5	–	% I_{PR}
Overcurrent Response Time	t_{OC_RESP}		–	1.7	2.7	μs

[1] Validated by design and characterization.

[2] Only enabled on 5 V devices.

[3] The sensor might continue to respond to current beyond the specified current sensing range, I_{PR} , until the output saturates at the high or low saturation voltage; however, the linearity and performance beyond the specified current sensing range are not validated.

[4] ACS37010 only.

[5] ACS37012 only.

[6] Where I_{OC} is the specific point at which the OCF trigger is to occur.

ACS37010 and ACS37012

450 kHz, High Accuracy Current Sensor With FAULT or Reference Output

ACS37010LLZATR-030B5 PERFORMANCE CHARACTERISTICS: Valid over full operating temperature range, $T_A = -40^\circ\text{C}$ to 150°C , $C_{\text{BYPASS}} = 100\text{ nF}$, and $V_{\text{DD}} = 5\text{ V}$, unless otherwise specified

Characteristic	Symbol	Test Conditions	Min.	Typ. ^[1]	Max.	Units
NOMINAL PERFORMANCE						
Current Sensing Range ^[2]	I_{PR}	Limited by $T_{\text{J(MAX)}} = 165^\circ\text{C}$	-30	-	30	A
Sensitivity	Sens	$I_{\text{PR(MIN)}} < I_{\text{P}} < I_{\text{PR(MAX)}}$	-	66.7	-	mV/A
Quiescent Voltage Output	V_{QVO}	$I_{\text{P}} = 0\text{ A}$	-	2.5	-	V
Reference Voltage Output	V_{REF}		-	2.5	-	V
ERROR COMPONENTS ^[1]						
Sensitivity Error	E_{SENS}	$I_{\text{P}} = 0.5 \times I_{\text{PR(MAX)}}$, $T_A = 25^\circ\text{C}$ to 150°C	-1.5	± 0.8	1.5	%
		$I_{\text{P}} = 0.5 \times I_{\text{PR(MAX)}}$, $T_A = -40^\circ\text{C}$ to 25°C	-1.5	± 0.8	1.5	%
Quiescent Voltage Output Error	$V_{\text{QVO_E}}$	$I_{\text{P}} = 0\text{ A}$, $T_A = 25^\circ\text{C}$ to 150°C	-8	± 5	8	mV
		$I_{\text{P}} = 0\text{ A}$, $T_A = -40^\circ\text{C}$ to 25°C	-8	± 5	8	mV
Reference Voltage Output Error	$V_{\text{REF_E}}$	$T_A = 25^\circ\text{C}$ to 150°C	-8	± 5	8	mV
		$T_A = -40^\circ\text{C}$ to 25°C	-8	± 5	8	mV
Offset Error	V_{OE}	$I_{\text{P}} = 0\text{ A}$, $T_A = 25^\circ\text{C}$ to 150°C	-4	± 2	4	mV
		$I_{\text{P}} = 0\text{ A}$, $T_A = -40^\circ\text{C}$ to 25°C	-4	± 2	4	mV
Noise	N	$T_A = 25^\circ\text{C}$, $C_{\text{L_VOUT}} = 6\text{ nF}$, $C_{\text{BYPASS}} = 1\text{ }\mu\text{F}$, $\text{BW} = 450\text{ kHz}$	-	8.5	-	mV _{RMS}
Power Supply Sensitivity Error	$E_{\text{SENS_PS}}$	$V_{\text{DD(MIN)}}$ to $V_{\text{DD(MAX)}}$	-1.2	± 0.7	1.2	%
Power Supply Quiescent Voltage Output Error	$V_{\text{QVO_PS}}$	$V_{\text{DD(MIN)}}$ to $V_{\text{DD(MAX)}}$	-9	± 6	9	mV
Power Supply Reference Voltage Output Error	$V_{\text{REF_PS}}$	$V_{\text{DD(MIN)}}$ to $V_{\text{DD(MAX)}}$	-9	± 6	9	mV
Power Supply Offset Error	$V_{\text{OE_PS}}$	$V_{\text{DD(MIN)}}$ to $V_{\text{DD(MAX)}}$	-8	± 5	8	mV
ERROR COMPONENTS INCLUDING LIFETIME DRIFT ^{[2][3]}						
Sensitivity Error Including Lifetime Drift	$E_{\text{SENS_LTD}}$	$I_{\text{P}} = 0.5 \times I_{\text{PR(MAX)}}$, $T_A = 25^\circ\text{C}$ to 150°C	-2.5	-	2.5	%
		$I_{\text{P}} = 0.5 \times I_{\text{PR(MAX)}}$, $T_A = -40^\circ\text{C}$ to 25°C	-3.5	-	3.5	%
Quiescent Voltage Output Error Including Lifetime Drift	$V_{\text{QVO_LTD}}$	$I_{\text{P}} = 0\text{ A}$, $T_A = 25^\circ\text{C}$ to 150°C	-10	-	10	mV
		$I_{\text{P}} = 0\text{ A}$, $T_A = -40^\circ\text{C}$ to 25°C	-10	-	10	mV
Reference Voltage Output Error Including Lifetime Drift	$V_{\text{REF_LTD}}$	$T_A = 25^\circ\text{C}$ to 150°C	-10	-	10	mV
		$T_A = -40^\circ\text{C}$ to 25°C	-10	-	10	mV
Offset Error Including Lifetime Drift	$V_{\text{OE_LTD}}$	$I_{\text{P}} = 0\text{ A}$, $T_A = 25^\circ\text{C}$ to 150°C	-3	-	3	mV
		$I_{\text{P}} = 0\text{ A}$, $T_A = -40^\circ\text{C}$ to 25°C	-3	-	3	mV

^[1] Typical values are the mean ± 3 sigma of production distributions.

^[2] Validated by design and characterization.

^[3] Lifetime drift minimum/maximum values are ± 3 sigma, and are based on a statistical combination of production distributions and worst-case drift distributions observed after AEC-Q100 qualification stresses.

ACS37010 and ACS37012

450 kHz, High Accuracy Current Sensor With FAULT or Reference Output

ACS37010LLZATR-030U5 PERFORMANCE CHARACTERISTICS: Valid over full operating temperature range, $T_A = -40^\circ\text{C}$ to 150°C , $C_{\text{BYPASS}} = 100\text{ nF}$, and $V_{\text{DD}} = 5\text{ V}$, unless otherwise specified

Characteristic	Symbol	Test Conditions	Min.	Typ. ^[1]	Max.	Units
NOMINAL PERFORMANCE						
Current Sensing Range ^[2]	I_{PR}	Limited by $T_{\text{J(MAX)}} = 165^\circ\text{C}$	0	–	30	A
Sensitivity	Sens	$I_{\text{PR(MIN)}} < I_{\text{P}} < I_{\text{PR(MAX)}}$	–	133.3	–	mV/A
Quiescent Voltage Output	V_{QVO}	$I_{\text{P}} = 0\text{ A}$	–	0.5	–	V
Reference Voltage Output	V_{REF}		–	0.5	–	V
ERROR COMPONENTS ^[1]						
Sensitivity Error	E_{SENS}	$I_{\text{P}} = 0.5 \times I_{\text{PR(MAX)}}$, $T_A = 25^\circ\text{C}$ to 150°C	–1.5	± 1	1.5	%
		$I_{\text{P}} = 0.5 \times I_{\text{PR(MAX)}}$, $T_A = -40^\circ\text{C}$ to 25°C	–1.5	± 1	1.5	%
Quiescent Voltage Output Error	$V_{\text{QVO_E}}$	$I_{\text{P}} = 0\text{ A}$, $T_A = 25^\circ\text{C}$ to 150°C	–8	± 5	8	mV
		$I_{\text{P}} = 0\text{ A}$, $T_A = -40^\circ\text{C}$ to 25°C	–8	± 5	8	mV
Reference Voltage Output Error	$V_{\text{REF_E}}$	$T_A = 25^\circ\text{C}$ to 150°C	–8	± 5	8	mV
		$T_A = -40^\circ\text{C}$ to 25°C	–8	± 5	8	mV
Offset Error	V_{OE}	$I_{\text{P}} = 0\text{ A}$, $T_A = 25^\circ\text{C}$ to 150°C	–4	± 3	4	mV
		$I_{\text{P}} = 0\text{ A}$, $T_A = -40^\circ\text{C}$ to 25°C	–4	± 3	4	mV
Noise	N	$T_A = 25^\circ\text{C}$, $C_{\text{L_VOUT}} = 6\text{ nF}$, $C_{\text{BYPASS}} = 1\text{ }\mu\text{F}$, $\text{BW} = 450\text{ kHz}$	–	17	–	mV _{RMS}
Power Supply Sensitivity Error	$E_{\text{SENS_PS}}$	$V_{\text{DD(MIN)}}$ to $V_{\text{DD(MAX)}}$	–1.2	± 0.8	1.2	%
Power Supply Quiescent Voltage Output Error	$V_{\text{QVO_PS}}$	$V_{\text{DD(MIN)}}$ to $V_{\text{DD(MAX)}}$	–9	± 6	9	mV
Power Supply Reference Voltage Output Error	$V_{\text{REF_PS}}$	$V_{\text{DD(MIN)}}$ to $V_{\text{DD(MAX)}}$	–9	± 6	9	mV
Power Supply Offset Error	$V_{\text{OE_PS}}$	$V_{\text{DD(MIN)}}$ to $V_{\text{DD(MAX)}}$	–8	± 5	8	mV
ERROR COMPONENTS INCLUDING LIFETIME DRIFT ^{[2][3]}						
Sensitivity Error Including Lifetime Drift	$E_{\text{SENS_LTD}}$	$I_{\text{P}} = 0.5 \times I_{\text{PR(MAX)}}$, $T_A = 25^\circ\text{C}$ to 150°C	–2.5	–	2.5	%
		$I_{\text{P}} = 0.5 \times I_{\text{PR(MAX)}}$, $T_A = -40^\circ\text{C}$ to 25°C	–3.5	–	3.5	%
Quiescent Voltage Output Error Including Lifetime Drift	$V_{\text{QVO_LTD}}$	$I_{\text{P}} = 0\text{ A}$, $T_A = 25^\circ\text{C}$ to 150°C	–10	–	10	mV
		$I_{\text{P}} = 0\text{ A}$, $T_A = -40^\circ\text{C}$ to 25°C	–10	–	10	mV
Reference Voltage Output Error Including Lifetime Drift	$V_{\text{REF_LTD}}$	$T_A = 25^\circ\text{C}$ to 150°C	–10	–	10	mV
		$T_A = -40^\circ\text{C}$ to 25°C	–10	–	10	mV
Offset Error Including Lifetime Drift	$V_{\text{OE_LTD}}$	$I_{\text{P}} = 0\text{ A}$, $T_A = 25^\circ\text{C}$ to 150°C	–4	–	4	mV
		$I_{\text{P}} = 0\text{ A}$, $T_A = -40^\circ\text{C}$ to 25°C	–4	–	4	mV

[1] Typical values are the mean ± 3 sigma of production distributions.

[2] Validated by design and characterization.

[3] Lifetime drift minimum/maximum values are ± 3 sigma, and are based on a statistical combination of production distributions and worst-case drift distributions observed after AEC-Q100 qualification stresses.

ACS37010 and ACS37012

450 kHz, High Accuracy Current Sensor With FAULT or Reference Output

ACS37010LLZATR-030B3 PERFORMANCE CHARACTERISTICS: Valid over full operating temperature range, $T_A = -40^\circ\text{C}$ to 150°C , $C_{\text{BYPASS}} = 100\text{ nF}$, and $V_{\text{DD}} = 3.3\text{ V}$, unless otherwise specified

Characteristic	Symbol	Test Conditions	Min.	Typ. ^[1]	Max.	Units
NOMINAL PERFORMANCE						
Current Sensing Range ^[2]	I_{PR}	Limited by $T_{\text{J(MAX)}} = 165^\circ\text{C}$	-30	-	30	A
Sensitivity	Sens	$I_{\text{PR(MIN)}} < I_{\text{P}} < I_{\text{PR(MAX)}}$	-	44	-	mV/A
Quiescent Voltage Output	V_{QVO}	$I_{\text{P}} = 0\text{ A}$	-	1.65	-	V
Reference Voltage Output	V_{REF}		-	1.65	-	V
ERROR COMPONENTS ^[1]						
Sensitivity Error	E_{SENS}	$I_{\text{P}} = 0.5 \times I_{\text{PR(MAX)}}$, $T_A = 25^\circ\text{C}$ to 150°C	-1.5	± 1	1.5	%
		$I_{\text{P}} = 0.5 \times I_{\text{PR(MAX)}}$, $T_A = -40^\circ\text{C}$ to 25°C	-1.5	± 1	1.5	%
Quiescent Voltage Output Error	$V_{\text{QVO_E}}$	$I_{\text{P}} = 0\text{ A}$, $T_A = 25^\circ\text{C}$ to 150°C	-8	± 4	8	mV
		$I_{\text{P}} = 0\text{ A}$, $T_A = -40^\circ\text{C}$ to 25°C	-8	± 4	8	mV
Reference Voltage Output Error	$V_{\text{REF_E}}$	$T_A = 25^\circ\text{C}$ to 150°C	-8	± 4	8	mV
		$T_A = -40^\circ\text{C}$ to 25°C	-8	± 4	8	mV
Offset Error	V_{OE}	$I_{\text{P}} = 0\text{ A}$, $T_A = 25^\circ\text{C}$ to 150°C	-3	± 1.5	3	mV
		$I_{\text{P}} = 0\text{ A}$, $T_A = -40^\circ\text{C}$ to 25°C	-3	± 2	3	mV
Noise	N	$T_A = 25^\circ\text{C}$, $C_{\text{L_VOUT}} = 6\text{ nF}$, $C_{\text{BYPASS}} = 1\text{ }\mu\text{F}$, $\text{BW} = 450\text{ kHz}$	-	8.5	-	mV _{RMS}
Power Supply Sensitivity Error	$E_{\text{SENS_PS}}$	$V_{\text{DD(MIN)}}$ to $V_{\text{DD(MAX)}}$	-1.4	± 1.2	1.4	%
Power Supply Quiescent Voltage Output Error	$V_{\text{QVO_PS}}$	$V_{\text{DD(MIN)}}$ to $V_{\text{DD(MAX)}}$	-6	± 3	6	mV
Power Supply Reference Voltage Output Error	$V_{\text{REF_PS}}$	$V_{\text{DD(MIN)}}$ to $V_{\text{DD(MAX)}}$	-6	± 3	6	mV
Power Supply Offset Error	$V_{\text{OE_PS}}$	$V_{\text{DD(MIN)}}$ to $V_{\text{DD(MAX)}}$	-6	± 3	6	mV
ERROR COMPONENTS INCLUDING LIFETIME DRIFT ^{[2][3]}						
Sensitivity Error Including Lifetime Drift	$E_{\text{SENS_LTD}}$	$I_{\text{P}} = 0.5 \times I_{\text{PR(MAX)}}$, $T_A = 25^\circ\text{C}$ to 150°C	-2.5	-	2.5	%
		$I_{\text{P}} = 0.5 \times I_{\text{PR(MAX)}}$, $T_A = -40^\circ\text{C}$ to 25°C	-3.5	-	3.5	%
Quiescent Voltage Output Error Including Lifetime Drift	$V_{\text{QVO_LTD}}$	$I_{\text{P}} = 0\text{ A}$, $T_A = 25^\circ\text{C}$ to 150°C	-10	-	10	mV
		$I_{\text{P}} = 0\text{ A}$, $T_A = -40^\circ\text{C}$ to 25°C	-10	-	10	mV
Reference Voltage Output Error Including Lifetime Drift	$V_{\text{REF_LTD}}$	$T_A = 25^\circ\text{C}$ to 150°C	-10	-	10	mV
		$T_A = -40^\circ\text{C}$ to 25°C	-10	-	10	mV
Offset Error Including Lifetime Drift	$V_{\text{OE_LTD}}$	$I_{\text{P}} = 0\text{ A}$, $T_A = 25^\circ\text{C}$ to 150°C	-3	-	3	mV
		$I_{\text{P}} = 0\text{ A}$, $T_A = -40^\circ\text{C}$ to 25°C	-3	-	3	mV

^[1] Typical values are the mean ± 3 sigma of production distributions.

^[2] Validated by design and characterization.

^[3] Lifetime drift minimum/maximum values are ± 3 sigma, and are based on a statistical combination of production distributions and worst-case drift distributions observed after AEC-Q100 qualification stresses.

ACS37010 and ACS37012

450 kHz, High Accuracy Current Sensor With FAULT or Reference Output

ACS37010LLZATR-050B5 PERFORMANCE CHARACTERISTICS: Valid over full operating temperature range, $T_A = -40^\circ\text{C}$ to 150°C , $C_{\text{BYPASS}} = 100\text{ nF}$, and $V_{\text{DD}} = 5\text{ V}$, unless otherwise specified

Characteristic	Symbol	Test Conditions	Min.	Typ. ^[1]	Max.	Units
NOMINAL PERFORMANCE						
Current Sensing Range ^[2]	I_{PR}	Limited by $T_{\text{J(MAX)}} = 165^\circ\text{C}$	-50	-	50	A
Sensitivity	Sens	$I_{\text{PR(MIN)}} < I_{\text{P}} < I_{\text{PR(MAX)}}$	-	40	-	mV/A
Quiescent Voltage Output	V_{QVO}	$I_{\text{P}} = 0\text{ A}$	-	2.5	-	V
Reference Voltage Output	V_{REF}		-	2.5	-	V
ERROR COMPONENTS ^[1]						
Sensitivity Error	E_{SENS}	$I_{\text{P}} = 0.5 \times I_{\text{PR(MAX)}}$, $T_A = 25^\circ\text{C}$ to 150°C	-1.5	± 1.1	1.5	%
		$I_{\text{P}} = 0.5 \times I_{\text{PR(MAX)}}$, $T_A = -40^\circ\text{C}$ to 25°C	-1.5	± 1.1	1.5	%
Quiescent Voltage Output Error	$V_{\text{QVO_E}}$	$I_{\text{P}} = 0\text{ A}$, $T_A = 25^\circ\text{C}$ to 150°C	-8	± 5	8	mV
		$I_{\text{P}} = 0\text{ A}$, $T_A = -40^\circ\text{C}$ to 25°C	-8	± 5	8	mV
Reference Voltage Output Error	$V_{\text{REF_E}}$	$T_A = 25^\circ\text{C}$ to 150°C	-8	± 5	8	mV
		$T_A = -40^\circ\text{C}$ to 25°C	-8	± 5	8	mV
Offset Error	V_{OE}	$I_{\text{P}} = 0\text{ A}$, $T_A = 25^\circ\text{C}$ to 150°C	-4	± 2	4	mV
		$I_{\text{P}} = 0\text{ A}$, $T_A = -40^\circ\text{C}$ to 25°C	-4	± 2	4	mV
Noise	N	$T_A = 25^\circ\text{C}$, $C_{\text{L_VOUT}} = 6\text{ nF}$, $C_{\text{BYPASS}} = 1\text{ }\mu\text{F}$, $\text{BW} = 450\text{ kHz}$	-	5	-	mV _{RMS}
Power Supply Sensitivity Error	$E_{\text{SENS_PS}}$	$V_{\text{DD(MIN)}}$ to $V_{\text{DD(MAX)}}$	-1.2	± 0.8	1.2	%
Power Supply Quiescent Voltage Output Error	$V_{\text{QVO_PS}}$	$V_{\text{DD(MIN)}}$ to $V_{\text{DD(MAX)}}$	-9	± 6	9	mV
Power Supply Reference Voltage Output Error	$V_{\text{REF_PS}}$	$V_{\text{DD(MIN)}}$ to $V_{\text{DD(MAX)}}$	-9	± 6	9	mV
Power Supply Offset Error	$V_{\text{OE_PS}}$	$V_{\text{DD(MIN)}}$ to $V_{\text{DD(MAX)}}$	-8	± 5	8	mV
ERROR COMPONENTS INCLUDING LIFETIME DRIFT ^{[2][3]}						
Sensitivity Error Including Lifetime Drift	$E_{\text{SENS_LTD}}$	$I_{\text{P}} = 0.5 \times I_{\text{PR(MAX)}}$, $T_A = 25^\circ\text{C}$ to 150°C	-3	-	3	%
		$I_{\text{P}} = 0.5 \times I_{\text{PR(MAX)}}$, $T_A = -40^\circ\text{C}$ to 25°C	-3.5	-	3.5	%
Quiescent Voltage Output Error Including Lifetime Drift	$V_{\text{QVO_LTD}}$	$I_{\text{P}} = 0\text{ A}$, $T_A = 25^\circ\text{C}$ to 150°C	-15	-	15	mV
		$I_{\text{P}} = 0\text{ A}$, $T_A = -40^\circ\text{C}$ to 25°C	-15	-	15	mV
Reference Voltage Output Error Including Lifetime Drift	$V_{\text{REF_LTD}}$	$T_A = 25^\circ\text{C}$ to 150°C	-15	-	15	mV
		$T_A = -40^\circ\text{C}$ to 25°C	-15	-	15	mV
Offset Error Including Lifetime Drift	$V_{\text{OE_LTD}}$	$I_{\text{P}} = 0\text{ A}$, $T_A = 25^\circ\text{C}$ to 150°C	-3	-	3	mV
		$I_{\text{P}} = 0\text{ A}$, $T_A = -40^\circ\text{C}$ to 25°C	-3	-	3	mV

^[1] Typical values are the mean ± 3 sigma of production distributions.

^[2] Validated by design and characterization.

^[3] Lifetime drift minimum/maximum values are ± 3 sigma, and are based on a statistical combination of production distributions and worst-case drift distributions observed after AEC-Q100 qualification stresses.

ACS37010 and ACS37012

450 kHz, High Accuracy Current Sensor With FAULT or Reference Output

ACS37010LLZATR-050B3 PERFORMANCE CHARACTERISTICS: Valid over full operating temperature range, $T_A = -40^\circ\text{C}$ to 150°C , $C_{\text{BYPASS}} = 100\text{ nF}$, and $V_{\text{DD}} = 3.3\text{ V}$, unless otherwise specified

Characteristic	Symbol	Test Conditions	Min.	Typ. ^[1]	Max.	Units
NOMINAL PERFORMANCE						
Current Sensing Range ^[2]	I_{PR}	Limited by $T_{\text{J(MAX)}} = 165^\circ\text{C}$	-50	-	50	A
Sensitivity	Sens	$I_{\text{PR(MIN)}} < I_{\text{P}} < I_{\text{PR(MAX)}}$	-	26.4	-	mV/A
Quiescent Voltage Output	V_{QVO}	$I_{\text{P}} = 0\text{ A}$	-	1.65	-	V
Reference Voltage Output	V_{REF}		-	1.65	-	V
ERROR COMPONENTS ^[1]						
Sensitivity Error	E_{SENS}	$I_{\text{P}} = 0.5 \times I_{\text{PR(MAX)}}$, $T_A = 25^\circ\text{C}$ to 150°C	-1.5	± 1.1	1.5	%
		$I_{\text{P}} = 0.5 \times I_{\text{PR(MAX)}}$, $T_A = -40^\circ\text{C}$ to 25°C	-1.5	± 1	1.5	%
Quiescent Voltage Output Error	$V_{\text{QVO_E}}$	$I_{\text{P}} = 0\text{ A}$, $T_A = 25^\circ\text{C}$ to 150°C	-8	± 4	8	mV
		$I_{\text{P}} = 0\text{ A}$, $T_A = -40^\circ\text{C}$ to 25°C	-8	± 4	8	mV
Reference Voltage Output Error	$V_{\text{REF_E}}$	$T_A = 25^\circ\text{C}$ to 150°C	-8	± 4	8	mV
		$T_A = -40^\circ\text{C}$ to 25°C	-8	± 4	8	mV
Offset Error	V_{OE}	$I_{\text{P}} = 0\text{ A}$, $T_A = 25^\circ\text{C}$ to 150°C	-3	± 1.5	3	mV
		$I_{\text{P}} = 0\text{ A}$, $T_A = -40^\circ\text{C}$ to 25°C	-3	± 1.5	3	mV
Noise	N	$T_A = 25^\circ\text{C}$, $C_{\text{L_VOUT}} = 6\text{ nF}$, $C_{\text{BYPASS}} = 1\text{ }\mu\text{F}$, $\text{BW} = 450\text{ kHz}$	-	5	-	mV _{RMS}
Power Supply Sensitivity Error	$E_{\text{SENS_PS}}$	$V_{\text{DD(MIN)}}$ to $V_{\text{DD(MAX)}}$	-1.4	± 1.1	1.4	%
Power Supply Quiescent Voltage Output Error	$V_{\text{QVO_PS}}$	$V_{\text{DD(MIN)}}$ to $V_{\text{DD(MAX)}}$	-6	± 3	6	mV
Power Supply Reference Voltage Output Error	$V_{\text{REF_PS}}$	$V_{\text{DD(MIN)}}$ to $V_{\text{DD(MAX)}}$	-6	± 3	6	mV
Power Supply Offset Error	$V_{\text{OE_PS}}$	$V_{\text{DD(MIN)}}$ to $V_{\text{DD(MAX)}}$	-6	± 3	6	mV
ERROR COMPONENTS INCLUDING LIFETIME DRIFT ^{[2][3]}						
Sensitivity Error Including Lifetime Drift	$E_{\text{SENS_LTD}}$	$I_{\text{P}} = 0.5 \times I_{\text{PR(MAX)}}$, $T_A = 25^\circ\text{C}$ to 150°C	-2.5	-	2.5	%
		$I_{\text{P}} = 0.5 \times I_{\text{PR(MAX)}}$, $T_A = -40^\circ\text{C}$ to 25°C	-3.5	-	3.5	%
Quiescent Voltage Output Error Including Lifetime Drift	$V_{\text{QVO_LTD}}$	$I_{\text{P}} = 0\text{ A}$, $T_A = 25^\circ\text{C}$ to 150°C	-13	-	13	mV
		$I_{\text{P}} = 0\text{ A}$, $T_A = -40^\circ\text{C}$ to 25°C	-13	-	13	mV
Reference Voltage Output Error Including Lifetime Drift	$V_{\text{REF_LTD}}$	$T_A = 25^\circ\text{C}$ to 150°C	-13	-	13	mV
		$T_A = -40^\circ\text{C}$ to 25°C	-13	-	13	mV
Offset Error Including Lifetime Drift	$V_{\text{OE_LTD}}$	$I_{\text{P}} = 0\text{ A}$, $T_A = 25^\circ\text{C}$ to 150°C	-3	-	3	mV
		$I_{\text{P}} = 0\text{ A}$, $T_A = -40^\circ\text{C}$ to 25°C	-3	-	3	mV

^[1] Typical values are the mean ± 3 sigma of production distributions.

^[2] Validated by design and characterization.

^[3] Lifetime drift minimum/maximum values are ± 3 sigma, and are based on a statistical combination of production distributions and worst-case drift distributions observed after AEC-Q100 qualification stresses.

ACS37010 and ACS37012

450 kHz, High Accuracy Current Sensor With FAULT or Reference Output

ACS37012LLZATR-030B5 PERFORMANCE CHARACTERISTICS: Valid over full operating temperature range, $T_A = -40^\circ\text{C}$ to 150°C , $C_{\text{BYPASS}} = 100\text{ nF}$, and $V_{\text{DD}} = 5\text{ V}$, unless otherwise specified

Characteristic	Symbol	Test Conditions	Min.	Typ. ^[1]	Max.	Units
NOMINAL PERFORMANCE						
Current Sensing Range ^[2]	I_{PR}	Limited by $T_{\text{J(MAX)}} = 165^\circ\text{C}$	-30	-	30	A
Sensitivity	Sens	$I_{\text{PR(MIN)}} < I_{\text{P}} < I_{\text{PR(MAX)}}$	-	66.7	-	mV/A
Quiescent Voltage Output	V_{QVO}	$I_{\text{P}} = 0\text{ A}$	-	2.5	-	V
Overcurrent FAULT Threshold	I_{OC}		-	100	-	% I_{PR}
Overcurrent FAULT Hysteresis	$I_{\text{OC_HYS}}$		-	2.9	-	A
FAULT ERROR						
Overcurrent Error	$I_{\text{OC_E}}$		-3	-	3	A
ERROR COMPONENTS ^[1]						
Sensitivity Error	E_{SENS}	$I_{\text{P}} = 0.5 \times I_{\text{PR(MAX)}}$, $T_A = 25^\circ\text{C}$ to 150°C	-1.5	± 0.8	1.5	%
		$I_{\text{P}} = 0.5 \times I_{\text{PR(MAX)}}$, $T_A = -40^\circ\text{C}$ to 25°C	-1.5	± 0.8	1.5	%
Quiescent Voltage Output Error	$V_{\text{QVO_E}}$	$I_{\text{P}} = 0\text{ A}$, $T_A = 25^\circ\text{C}$ to 150°C	-8	± 5	8	mV
		$I_{\text{P}} = 0\text{ A}$, $T_A = -40^\circ\text{C}$ to 25°C	-8	± 5	8	mV
Noise	N	$T_A = 25^\circ\text{C}$, $C_{\text{L_VOUT}} = 6\text{ nF}$, $C_{\text{BYPASS}} = 1\text{ }\mu\text{F}$, $\text{BW} = 450\text{ kHz}$	-	8.5	-	mV_{RMS}
Power Supply Sensitivity Error	$E_{\text{SENS_PS}}$	$V_{\text{DD(MIN)}}$ to $V_{\text{DD(MAX)}}$	-1.2	± 0.7	1.2	%
Power Supply Quiescent Voltage Output Error	$V_{\text{QVO_PS}}$	$V_{\text{DD(MIN)}}$ to $V_{\text{DD(MAX)}}$	-9	± 6	9	mV
ERROR COMPONENTS INCLUDING LIFETIME DRIFT ^{[2][3]}						
Sensitivity Error Including Lifetime Drift	$E_{\text{SENS_LTD}}$	$I_{\text{P}} = 0.5 \times I_{\text{PR(MAX)}}$, $T_A = 25^\circ\text{C}$ to 150°C	-2.5	-	2.5	%
		$I_{\text{P}} = 0.5 \times I_{\text{PR(MAX)}}$, $T_A = -40^\circ\text{C}$ to 25°C	-3.5	-	3.5	%
Quiescent Voltage Output Error Including Lifetime Drift	$V_{\text{QVO_LTD}}$	$I_{\text{P}} = 0\text{ A}$, $T_A = 25^\circ\text{C}$ to 150°C	-10	-	10	mV
		$I_{\text{P}} = 0\text{ A}$, $T_A = -40^\circ\text{C}$ to 25°C	-10	-	10	mV

[1] Typical values are the mean ± 3 sigma of production distributions.

[2] Validated by design and characterization.

[3] Lifetime drift minimum/maximum values are ± 3 sigma, and are based on a statistical combination of production distributions and worst-case drift distributions observed after AEC-Q100 qualification stresses.

ACS37010 and ACS37012

450 kHz, High Accuracy Current Sensor With FAULT or Reference Output

ACS37012LLZATR-030B3 PERFORMANCE CHARACTERISTICS: Valid over full operating temperature range, $T_A = -40^\circ\text{C}$ to 150°C , $C_{\text{BYPASS}} = 100\text{ nF}$, and $V_{\text{DD}} = 3.3\text{ V}$, unless otherwise specified

Characteristic	Symbol	Test Conditions	Min.	Typ. ^[1]	Max.	Units
NOMINAL PERFORMANCE						
Current Sensing Range ^[2]	I_{PR}	Limited by $T_{\text{J(MAX)}} = 165^\circ\text{C}$	-30	-	30	A
Sensitivity	Sens	$I_{\text{PR(MIN)}} < I_{\text{P}} < I_{\text{PR(MAX)}}$	-	44	-	mV/A
Quiescent Voltage Output	V_{QVO}	$I_{\text{P}} = 0\text{ A}$	-	1.65	-	V
Overcurrent FAULT Threshold	I_{OC}		-	100	-	% I_{PR}
Overcurrent FAULT Hysteresis	$I_{\text{OC_HYS}}$		-	2.9	-	A
FAULT ERROR						
Overcurrent Error	$I_{\text{OC_E}}$		-3	-	3	A
ERROR COMPONENTS ^[1]						
Sensitivity Error	E_{SENS}	$I_{\text{P}} = 0.5 \times I_{\text{PR(MAX)}}$, $T_A = 25^\circ\text{C}$ to 150°C	-1.5	± 1	1.5	%
		$I_{\text{P}} = 0.5 \times I_{\text{PR(MAX)}}$, $T_A = -40^\circ\text{C}$ to 25°C	-1.5	± 1	1.5	%
Quiescent Voltage Output Error	$V_{\text{QVO_E}}$	$I_{\text{P}} = 0\text{ A}$, $T_A = 25^\circ\text{C}$ to 150°C	-8	± 4	8	mV
		$I_{\text{P}} = 0\text{ A}$, $T_A = -40^\circ\text{C}$ to 25°C	-8	± 4	8	mV
Noise	N	$T_A = 25^\circ\text{C}$, $C_{\text{L_VOUT}} = 6\text{ nF}$, $C_{\text{BYPASS}} = 1\text{ }\mu\text{F}$, $\text{BW} = 450\text{ kHz}$	-	8.5	-	mV_{RMS}
Power Supply Sensitivity Error	$E_{\text{SENS_PS}}$	$V_{\text{DD(MIN)}}$ to $V_{\text{DD(MAX)}}$	-1.4	± 1.2	1.4	%
Power Supply Quiescent Voltage Output Error	$V_{\text{QVO_PS}}$	$V_{\text{DD(MIN)}}$ to $V_{\text{DD(MAX)}}$	-6	± 3	6	mV
ERROR COMPONENTS INCLUDING LIFETIME DRIFT ^{[2][3]}						
Sensitivity Error Including Lifetime Drift	$E_{\text{SENS_LTD}}$	$I_{\text{P}} = 0.5 \times I_{\text{PR(MAX)}}$, $T_A = 25^\circ\text{C}$ to 150°C	-2.5	-	2.5	%
		$I_{\text{P}} = 0.5 \times I_{\text{PR(MAX)}}$, $T_A = -40^\circ\text{C}$ to 25°C	-3.5	-	3.5	%
Quiescent Voltage Output Error Including Lifetime Drift	$V_{\text{QVO_LTD}}$	$I_{\text{P}} = 0\text{ A}$, $T_A = 25^\circ\text{C}$ to 150°C	-10	-	10	mV
		$I_{\text{P}} = 0\text{ A}$, $T_A = -40^\circ\text{C}$ to 25°C	-10	-	10	mV

^[1] Typical values are the mean ± 3 sigma of production distributions.

^[2] Validated by design and characterization.

^[3] Lifetime drift minimum/maximum values are ± 3 sigma, and are based on a statistical combination of production distributions and worst-case drift distributions observed after AEC-Q100 qualification stresses.

ACS37010 and ACS37012

450 kHz, High Accuracy Current Sensor With FAULT or Reference Output

ACS37012LLZATR-050B5 PERFORMANCE CHARACTERISTICS: Valid over full operating temperature range, $T_A = -40^\circ\text{C}$ to 150°C , $C_{\text{BYPASS}} = 100\text{ nF}$, and $V_{\text{DD}} = 5\text{ V}$, unless otherwise specified

Characteristic	Symbol	Test Conditions	Min.	Typ. ^[1]	Max.	Units
NOMINAL PERFORMANCE						
Current Sensing Range ^[2]	I_{PR}	Limited by $T_{\text{J(MAX)}} = 165^\circ\text{C}$	-50	-	50	A
Sensitivity	Sens	$I_{\text{PR(MIN)}} < I_{\text{P}} < I_{\text{PR(MAX)}}$	-	40	-	mV/A
Quiescent Voltage Output	V_{QVO}	$I_{\text{P}} = 0\text{ A}$	-	2.5	-	V
Overcurrent FAULT Threshold	I_{OC}		-	100	-	% I_{PR}
Overcurrent FAULT Hysteresis	$I_{\text{OC_HYS}}$		-	4.8	-	A
FAULT ERROR						
Overcurrent Error	$I_{\text{OC_E}}$		-5	-	5	A
ERROR COMPONENTS ^[1]						
Sensitivity Error	E_{SENS}	$I_{\text{P}} = 0.5 \times I_{\text{PR(MAX)}}$, $T_A = 25^\circ\text{C}$ to 150°C	-1.5	± 1.1	1.5	%
		$I_{\text{P}} = 0.5 \times I_{\text{PR(MAX)}}$, $T_A = -40^\circ\text{C}$ to 25°C	-1.5	± 1.1	1.5	%
Quiescent Voltage Output Error	$V_{\text{QVO_E}}$	$I_{\text{P}} = 0\text{ A}$, $T_A = 25^\circ\text{C}$ to 150°C	-8	± 5	8	mV
		$I_{\text{P}} = 0\text{ A}$, $T_A = -40^\circ\text{C}$ to 25°C	-8	± 5	8	mV
Noise	N	$T_A = 25^\circ\text{C}$, $C_{\text{L_VOUT}} = 6\text{ nF}$, $C_{\text{BYPASS}} = 1\text{ }\mu\text{F}$, $\text{BW} = 450\text{ kHz}$	-	5	-	mV_{RMS}
Power Supply Sensitivity Error	$E_{\text{SENS_PS}}$	$V_{\text{DD(MIN)}}$ to $V_{\text{DD(MAX)}}$	-1.2	± 0.8	1.2	%
Power Supply Quiescent Voltage Output Error	$V_{\text{QVO_PS}}$	$V_{\text{DD(MIN)}}$ to $V_{\text{DD(MAX)}}$	-9	± 6	9	mV
ERROR COMPONENTS INCLUDING LIFETIME DRIFT ^{[2][3]}						
Sensitivity Error Including Lifetime Drift	$E_{\text{SENS_LTD}}$	$I_{\text{P}} = 0.5 \times I_{\text{PR(MAX)}}$, $T_A = 25^\circ\text{C}$ to 150°C	-3	-	3	%
		$I_{\text{P}} = 0.5 \times I_{\text{PR(MAX)}}$, $T_A = -40^\circ\text{C}$ to 25°C	-3.5	-	3.5	%
Quiescent Voltage Output Error Including Lifetime Drift	$V_{\text{QVO_LTD}}$	$I_{\text{P}} = 0\text{ A}$, $T_A = 25^\circ\text{C}$ to 150°C	-15	-	15	mV
		$I_{\text{P}} = 0\text{ A}$, $T_A = -40^\circ\text{C}$ to 25°C	-15	-	15	mV

[1] Typical values are the mean ± 3 sigma of production distributions.

[2] Validated by design and characterization.

[3] Lifetime drift minimum/maximum values are ± 3 sigma, and are based on a statistical combination of production distributions and worst-case drift distributions observed after AEC-Q100 qualification stresses.

ACS37010 and ACS37012

450 kHz, High Accuracy Current Sensor With FAULT or Reference Output

ACS37012LLZATR-050B3 PERFORMANCE CHARACTERISTICS: Valid over full operating temperature range, $T_A = -40^\circ\text{C}$ to 150°C , $C_{\text{BYPASS}} = 100\text{ nF}$, and $V_{\text{DD}} = 3.3\text{ V}$, unless otherwise specified

Characteristic	Symbol	Test Conditions	Min.	Typ. ^[1]	Max.	Units
NOMINAL PERFORMANCE						
Current Sensing Range ^[2]	I_{PR}	Limited by $T_{\text{J(MAX)}} = 165^\circ\text{C}$	-50	-	50	A
Sensitivity	Sens	$I_{\text{PR(MIN)}} < I_{\text{P}} < I_{\text{PR(MAX)}}$	-	26.4	-	mV/A
Quiescent Voltage Output	V_{QVO}	$I_{\text{P}} = 0\text{ A}$	-	1.65	-	V
Overcurrent FAULT Threshold	I_{OC}		-	100	-	% I_{PR}
Overcurrent FAULT Hysteresis	$I_{\text{OC_HYS}}$		-	4.8	-	A
FAULT ERROR						
Overcurrent Error	$I_{\text{OC_E}}$		-5	-	5	A
ERROR COMPONENTS						
Sensitivity Error	E_{SENS}	$I_{\text{P}} = 0.5 \times I_{\text{PR(MAX)}}$, $T_A = 25^\circ\text{C}$ to 150°C	-1.5	± 1.1	1.5	%
		$I_{\text{P}} = 0.5 \times I_{\text{PR(MAX)}}$, $T_A = -40^\circ\text{C}$ to 25°C	-1.5	± 1	1.5	%
Quiescent Voltage Output Error	$V_{\text{QVO_E}}$	$I_{\text{P}} = 0\text{ A}$, $T_A = 25^\circ\text{C}$ to 150°C	-8	± 4	8	mV
		$I_{\text{P}} = 0\text{ A}$, $T_A = -40^\circ\text{C}$ to 25°C	-8	± 4	8	mV
Noise	N	$T_A = 25^\circ\text{C}$, $C_{\text{L_VOUT}} = 6\text{ nF}$, $C_{\text{BYPASS}} = 1\text{ }\mu\text{F}$, $\text{BW} = 450\text{ kHz}$	-	5	-	mV_{RMS}
Power Supply Sensitivity Error	$E_{\text{SENS_PS}}$	$V_{\text{DD(MIN)}}$ to $V_{\text{DD(MAX)}}$	-1.4	± 1.1	1.4	%
Power Supply Quiescent Voltage Output Error	$V_{\text{QVO_PS}}$	$V_{\text{DD(MIN)}}$ to $V_{\text{DD(MAX)}}$	-6	± 3	6	mV
ERROR COMPONENTS INCLUDING LIFETIME DRIFT ^{[2][3]}						
Sensitivity Error Including Lifetime Drift	$E_{\text{SENS_LTD}}$	$I_{\text{P}} = 0.5 \times I_{\text{PR(MAX)}}$, $T_A = 25^\circ\text{C}$ to 150°C	-2.5	-	2.5	%
		$I_{\text{P}} = 0.5 \times I_{\text{PR(MAX)}}$, $T_A = -40^\circ\text{C}$ to 25°C	-3.5	-	3.5	%
Quiescent Voltage Output Error Including Lifetime Drift	$V_{\text{QVO_LTD}}$	$I_{\text{P}} = 0\text{ A}$, $T_A = 25^\circ\text{C}$ to 150°C	-13	-	13	mV
		$I_{\text{P}} = 0\text{ A}$, $T_A = -40^\circ\text{C}$ to 25°C	-13	-	13	mV

[1] Typical values are the mean ± 3 sigma of production distributions.

[2] Validated by design and characterization.

[3] Lifetime drift minimum/maximum values are ± 3 sigma, and are based on a statistical combination of production distributions and worst-case drift distributions observed after AEC-Q100 qualification stresses.

ACS37010 and ACS37012

450 kHz, High Accuracy Current Sensor With FAULT or Reference Output

ACS37010LLCTR-010B5 PERFORMANCE CHARACTERISTICS: Valid over full operating temperature range, $T_A = -40^\circ\text{C}$ to 150°C , $C_{\text{BYPASS}} = 100\text{ nF}$, and $V_{\text{DD}} = 5\text{ V}$, unless otherwise specified

Characteristic	Symbol	Test Conditions	Min.	Typ. ^[1]	Max.	Units
NOMINAL PERFORMANCE						
Current Sensing Range ^[2]	I_{PR}	Limited by $T_{\text{J(MAX)}} = 165^\circ\text{C}$	-10	-	10	A
Sensitivity	Sens	$I_{\text{PR(MIN)}} < I_{\text{P}} < I_{\text{PR(MAX)}}$	-	200	-	mV/A
Quiescent Voltage Output	V_{QVO}	$I_{\text{P}} = 0\text{ A}$	-	2.5	-	V
Reference Voltage Output	V_{REF}		-	2.5	-	V
ERROR COMPONENTS ^[1]						
Sensitivity Error	E_{SENS}	$I_{\text{P}} = 0.5 \times I_{\text{PR(MAX)}}$, $T_A = 25^\circ\text{C}$ to 150°C	-1.5	± 1	1.5	%
		$I_{\text{P}} = 0.5 \times I_{\text{PR(MAX)}}$, $T_A = -40^\circ\text{C}$ to 25°C	-1.5	± 1	1.5	%
Quiescent Voltage Output Error	$V_{\text{QVO_E}}$	$I_{\text{P}} = 0\text{ A}$, $T_A = 25^\circ\text{C}$ to 150°C	-8	± 3	8	mV
		$I_{\text{P}} = 0\text{ A}$, $T_A = -40^\circ\text{C}$ to 25°C	-8	± 3	8	mV
Reference Voltage Output Error	$V_{\text{REF_E}}$	$T_A = 25^\circ\text{C}$ to 150°C	-8	± 3	8	mV
		$T_A = -40^\circ\text{C}$ to 25°C	-8	± 3	8	mV
Offset Error	V_{OE}	$I_{\text{P}} = 0\text{ A}$, $T_A = 25^\circ\text{C}$ to 150°C	-5	± 3	5	mV
		$I_{\text{P}} = 0\text{ A}$, $T_A = -40^\circ\text{C}$ to 25°C	-5	± 3	5	mV
Noise	N	$T_A = 25^\circ\text{C}$, $C_{\text{L_VOUT}} = 6\text{ nF}$, $C_{\text{BYPASS}} = 1\text{ }\mu\text{F}$, $\text{BW} = 450\text{ kHz}$	-	12	-	mV _{RMS}
Power Supply Sensitivity Error	$E_{\text{SENS_PS}}$	$V_{\text{DD(MIN)}}$ to $V_{\text{DD(MAX)}}$	-1.2	± 0.7	1.2	%
Power Supply Quiescent Voltage Output Error	$V_{\text{QVO_PS}}$	$V_{\text{DD(MIN)}}$ to $V_{\text{DD(MAX)}}$	-9	± 4	9	mV
Power Supply Reference Voltage Output Error	$V_{\text{REF_PS}}$	$V_{\text{DD(MIN)}}$ to $V_{\text{DD(MAX)}}$	-9	± 3	9	mV
Power Supply Offset Error	$V_{\text{OE_PS}}$	$V_{\text{DD(MIN)}}$ to $V_{\text{DD(MAX)}}$	-8	± 3	8	mV
ERROR COMPONENTS INCLUDING LIFETIME DRIFT ^{[2][3]}						
Sensitivity Error Including Lifetime Drift	$E_{\text{SENS_LTD}}$	$I_{\text{P}} = 0.5 \times I_{\text{PR(MAX)}}$, $T_A = 25^\circ\text{C}$ to 150°C	-	± 1.3	-	%
		$I_{\text{P}} = 0.5 \times I_{\text{PR(MAX)}}$, $T_A = -40^\circ\text{C}$ to 25°C	-	± 1.3	-	%
Quiescent Voltage Output Error Including Lifetime Drift	$V_{\text{QVO_LTD}}$	$I_{\text{P}} = 0\text{ A}$, $T_A = 25^\circ\text{C}$ to 150°C	-	± 2.7	-	mV
		$I_{\text{P}} = 0\text{ A}$, $T_A = -40^\circ\text{C}$ to 25°C	-	± 2.7	-	mV
Reference Voltage Output Error Including Lifetime Drift	$V_{\text{REF_LTD}}$	$T_A = 25^\circ\text{C}$ to 150°C	-	± 3.5	-	mV
		$T_A = -40^\circ\text{C}$ to 25°C	-	± 3.5	-	mV
Offset Error Including Lifetime Drift	$V_{\text{OE_LTD}}$	$I_{\text{P}} = 0\text{ A}$, $T_A = 25^\circ\text{C}$ to 150°C	-	± 1.4	-	mV
		$I_{\text{P}} = 0\text{ A}$, $T_A = -40^\circ\text{C}$ to 25°C	-	± 1.4	-	mV

^[1] Typical values are the mean ± 3 sigma of production distributions.

^[2] Validated by design and characterization.

^[3] Lifetime drift characteristics are based on the AEC-Q100 qualification results from zero-hour reads. Typical values are the worst-case mean drift observed during AEC-Q100 qualification from any of the -40°C , 25°C , or 150°C temperatures.

ACS37010 and ACS37012

450 kHz, High Accuracy Current Sensor With FAULT or Reference Output

ACS37010LLCTR-010B3 PERFORMANCE CHARACTERISTICS: Valid over full operating temperature range, $T_A = -40^\circ\text{C}$ to 150°C , $C_{\text{BYPASS}} = 100\text{ nF}$, and $V_{\text{DD}} = 5\text{ V}$, unless otherwise specified

Characteristic	Symbol	Test Conditions	Min.	Typ. ^[1]	Max.	Units
NOMINAL PERFORMANCE						
Current Sensing Range ^[2]	I_{PR}	Limited by $T_{\text{J(MAX)}} = 165^\circ\text{C}$	-10	-	10	A
Sensitivity	Sens	$I_{\text{PR(MIN)}} < I_{\text{P}} < I_{\text{PR(MAX)}}$	-	132	-	mV/A
Quiescent Voltage Output	V_{QVO}	$I_{\text{P}} = 0\text{ A}$	-	1.65	-	V
Reference Voltage Output	V_{REF}		-	1.65	-	V
ERROR COMPONENTS ^[1]						
Sensitivity Error	E_{SENS}	$I_{\text{P}} = 0.5 \times I_{\text{PR(MAX)}}$, $T_A = 25^\circ\text{C}$ to 150°C	-1.5	± 1	1.5	%
		$I_{\text{P}} = 0.5 \times I_{\text{PR(MAX)}}$, $T_A = -40^\circ\text{C}$ to 25°C	-1.5	± 1	1.5	%
Quiescent Voltage Output Error	$V_{\text{QVO_E}}$	$I_{\text{P}} = 0\text{ A}$, $T_A = 25^\circ\text{C}$ to 150°C	-8	± 2	8	mV
		$I_{\text{P}} = 0\text{ A}$, $T_A = -40^\circ\text{C}$ to 25°C	-8	± 2	8	mV
Reference Voltage Output Error	$V_{\text{REF_E}}$	$T_A = 25^\circ\text{C}$ to 150°C	-8	± 2	8	mV
		$T_A = -40^\circ\text{C}$ to 25°C	-8	± 2	8	mV
Offset Error	V_{OE}	$I_{\text{P}} = 0\text{ A}$, $T_A = 25^\circ\text{C}$ to 150°C	-5	± 2	5	mV
		$I_{\text{P}} = 0\text{ A}$, $T_A = -40^\circ\text{C}$ to 25°C	-5	± 2	5	mV
Noise	N	$T_A = 25^\circ\text{C}$, $C_{\text{L_VOUT}} = 6\text{ nF}$, $C_{\text{BYPASS}} = 1\text{ }\mu\text{F}$, $\text{BW} = 450\text{ kHz}$	-	12	-	mV _{RMS}
Power Supply Sensitivity Error	$E_{\text{SENS_PS}}$	$V_{\text{DD(MIN)}}$ to $V_{\text{DD(MAX)}}$	-1.4	± 1	1.4	%
Power Supply Quiescent Voltage Output Error	$V_{\text{QVO_PS}}$	$V_{\text{DD(MIN)}}$ to $V_{\text{DD(MAX)}}$	-6	± 3	6	mV
Power Supply Reference Voltage Output Error	$V_{\text{REF_PS}}$	$V_{\text{DD(MIN)}}$ to $V_{\text{DD(MAX)}}$	-6	± 2	6	mV
Power Supply Offset Error	$V_{\text{OE_PS}}$	$V_{\text{DD(MIN)}}$ to $V_{\text{DD(MAX)}}$	-6	± 3	6	mV
ERROR COMPONENTS INCLUDING LIFETIME DRIFT ^{[2][3]}						
Sensitivity Error Including Lifetime Drift	$E_{\text{SENS_LTD}}$	$I_{\text{P}} = 0.5 \times I_{\text{PR(MAX)}}$, $T_A = 25^\circ\text{C}$ to 150°C	-	± 1.3	-	%
		$I_{\text{P}} = 0.5 \times I_{\text{PR(MAX)}}$, $T_A = -40^\circ\text{C}$ to 25°C	-	± 1.3	-	%
Quiescent Voltage Output Error Including Lifetime Drift	$V_{\text{QVO_LTD}}$	$I_{\text{P}} = 0\text{ A}$, $T_A = 25^\circ\text{C}$ to 150°C	-	± 2.7	-	mV
		$I_{\text{P}} = 0\text{ A}$, $T_A = -40^\circ\text{C}$ to 25°C	-	± 2.7	-	mV
Reference Voltage Output Error Including Lifetime Drift	$V_{\text{REF_LTD}}$	$T_A = 25^\circ\text{C}$ to 150°C	-	± 3.5	-	mV
		$T_A = -40^\circ\text{C}$ to 25°C	-	± 3.5	-	mV
Offset Error Including Lifetime Drift	$V_{\text{OE_LTD}}$	$I_{\text{P}} = 0\text{ A}$, $T_A = 25^\circ\text{C}$ to 150°C	-	± 1.4	-	mV
		$I_{\text{P}} = 0\text{ A}$, $T_A = -40^\circ\text{C}$ to 25°C	-	± 1.4	-	mV

[1] Typical values are the mean ± 3 sigma of production distributions.

[2] Validated by design and characterization.

[3] Lifetime drift characteristics are based on the AEC-Q100 qualification results from zero-hour reads. Typical values are the worst-case mean drift observed during AEC-Q100 qualification from any of the -40°C , 25°C , or 150°C temperatures.

ACS37010 and ACS37012

450 kHz, High Accuracy Current Sensor With FAULT or Reference Output

ACS37010LLCTR-050B5 PERFORMANCE CHARACTERISTICS: Valid over full operating temperature range,

$T_A = -40^\circ\text{C}$ to 150°C , $C_{\text{BYPASS}} = 100\text{ nF}$, and $V_{\text{DD}} = 5\text{ V}$, unless otherwise specified

Characteristic	Symbol	Test Conditions	Min.	Typ. ^[1]	Max.	Units
NOMINAL PERFORMANCE						
Current Sensing Range ^[2]	I_{PR}	Limited by $T_{\text{J(MAX)}} = 165^\circ\text{C}$	-50	-	50	A
Sensitivity	Sens	$I_{\text{PR(MIN)}} < I_{\text{P}} < I_{\text{PR(MAX)}}$	-	40	-	mV/A
Quiescent Voltage Output	V_{QVO}	$I_{\text{P}} = 0\text{ A}$	-	2.5	-	V
Reference Voltage Output	V_{REF}		-	2.5	-	V
ERROR COMPONENTS ^[1]						
Sensitivity Error	E_{SENS}	$I_{\text{P}} = 0.5 \times I_{\text{PR(MAX)}}$, $T_A = 25^\circ\text{C}$ to 150°C	-1.5	± 1	1.5	%
		$I_{\text{P}} = 0.5 \times I_{\text{PR(MAX)}}$, $T_A = -40^\circ\text{C}$ to 25°C	-1.5	± 1	1.5	%
Quiescent Voltage Output Error	$V_{\text{QVO_E}}$	$I_{\text{P}} = 0\text{ A}$, $T_A = 25^\circ\text{C}$ to 150°C	-8	± 2	8	mV
		$I_{\text{P}} = 0\text{ A}$, $T_A = -40^\circ\text{C}$ to 25°C	-8	± 2	8	mV
Reference Voltage Output Error	$V_{\text{REF_E}}$	$T_A = 25^\circ\text{C}$ to 150°C	-8	± 2	8	mV
		$T_A = -40^\circ\text{C}$ to 25°C	-8	± 2	8	mV
Offset Error	V_{OE}	$I_{\text{P}} = 0\text{ A}$, $T_A = 25^\circ\text{C}$ to 150°C	-4	± 1	4	mV
		$I_{\text{P}} = 0\text{ A}$, $T_A = -40^\circ\text{C}$ to 25°C	-4	± 1	4	mV
Noise	N	$T_A = 25^\circ\text{C}$, $C_{\text{L_VOUT}} = 6\text{ nF}$, $C_{\text{BYPASS}} = 1\text{ }\mu\text{F}$, $\text{BW} = 450\text{ kHz}$	-	5	-	mV _{RMS}
Power Supply Sensitivity Error	$E_{\text{SENS_PS}}$	$V_{\text{DD(MIN)}}$ to $V_{\text{DD(MAX)}}$	-1.2	± 0.7	1.2	%
Power Supply Quiescent Voltage Output Error	$V_{\text{QVO_PS}}$	$V_{\text{DD(MIN)}}$ to $V_{\text{DD(MAX)}}$	-9	± 3	9	mV
Power Supply Reference Voltage Output Error	$V_{\text{REF_PS}}$	$V_{\text{DD(MIN)}}$ to $V_{\text{DD(MAX)}}$	-9	± 3	9	mV
Power Supply Offset Error	$V_{\text{OE_PS}}$	$V_{\text{DD(MIN)}}$ to $V_{\text{DD(MAX)}}$	-8	± 3	8	mV
ERROR COMPONENTS INCLUDING LIFETIME DRIFT ^{[2][3]}						
Sensitivity Error Including Lifetime Drift	$E_{\text{SENS_LTD}}$	$I_{\text{P}} = 0.5 \times I_{\text{PR(MAX)}}$, $T_A = 25^\circ\text{C}$ to 150°C	-	± 1.3	-	%
		$I_{\text{P}} = 0.5 \times I_{\text{PR(MAX)}}$, $T_A = -40^\circ\text{C}$ to 25°C	-	± 1.3	-	%
Quiescent Voltage Output Error Including Lifetime Drift	$V_{\text{QVO_LTD}}$	$I_{\text{P}} = 0\text{ A}$, $T_A = 25^\circ\text{C}$ to 150°C	-	± 2.7	-	mV
		$I_{\text{P}} = 0\text{ A}$, $T_A = -40^\circ\text{C}$ to 25°C	-	± 2.7	-	mV
Reference Voltage Output Error Including Lifetime Drift	$V_{\text{REF_LTD}}$	$T_A = 25^\circ\text{C}$ to 150°C	-	± 3.5	-	mV
		$T_A = -40^\circ\text{C}$ to 25°C	-	± 3.5	-	mV
Offset Error Including Lifetime Drift	$V_{\text{OE_LTD}}$	$I_{\text{P}} = 0\text{ A}$, $T_A = 25^\circ\text{C}$ to 150°C	-	± 1.4	-	mV
		$I_{\text{P}} = 0\text{ A}$, $T_A = -40^\circ\text{C}$ to 25°C	-	± 1.4	-	mV

^[1] Typical values are the mean ± 3 sigma of production distributions.

^[2] Validated by design and characterization.

^[3] Lifetime drift characteristics are based on the AEC-Q100 qualification results from zero-hour reads. Typical values are the worst-case mean drift observed during AEC-Q100 qualification from any of the -40°C , 25°C , or 150°C temperatures.

ACS37010 and ACS37012

450 kHz, High Accuracy Current Sensor With FAULT or Reference Output

ACS37010LLCTR-050B3 PERFORMANCE CHARACTERISTICS: Valid over full operating temperature range,

$T_A = -40^\circ\text{C}$ to 150°C , $C_{\text{BYPASS}} = 100\text{ nF}$, and $V_{\text{DD}} = 5\text{ V}$, unless otherwise specified

Characteristic	Symbol	Test Conditions	Min.	Typ. ^[1]	Max.	Units
NOMINAL PERFORMANCE						
Current Sensing Range ^[2]	I_{PR}	Limited by $T_{\text{J(MAX)}} = 165^\circ\text{C}$	-50	-	50	A
Sensitivity	Sens	$I_{\text{PR(MIN)}} < I_{\text{P}} < I_{\text{PR(MAX)}}$	-	26.4	-	mV/A
Quiescent Voltage Output	V_{QVO}	$I_{\text{P}} = 0\text{ A}$	-	1.65	-	V
Reference Voltage Output	V_{REF}		-	1.65	-	V
ERROR COMPONENTS ^[1]						
Sensitivity Error	E_{SENS}	$I_{\text{P}} = 0.5 \times I_{\text{PR(MAX)}}$, $T_A = 25^\circ\text{C}$ to 150°C	-1.5	± 1	1.5	%
		$I_{\text{P}} = 0.5 \times I_{\text{PR(MAX)}}$, $T_A = -40^\circ\text{C}$ to 25°C	-1.5	± 1	1.5	%
Quiescent Voltage Output Error	$V_{\text{QVO_E}}$	$I_{\text{P}} = 0\text{ A}$, $T_A = 25^\circ\text{C}$ to 150°C	-8	± 2	8	mV
		$I_{\text{P}} = 0\text{ A}$, $T_A = -40^\circ\text{C}$ to 25°C	-8	± 2	8	mV
Reference Voltage Output Error	$V_{\text{REF_E}}$	$T_A = 25^\circ\text{C}$ to 150°C	-8	± 2	8	mV
		$T_A = -40^\circ\text{C}$ to 25°C	-8	± 2	8	mV
Offset Error	V_{OE}	$I_{\text{P}} = 0\text{ A}$, $T_A = 25^\circ\text{C}$ to 150°C	-4	± 1	4	mV
		$I_{\text{P}} = 0\text{ A}$, $T_A = -40^\circ\text{C}$ to 25°C	-4	± 1	4	mV
Noise	N	$T_A = 25^\circ\text{C}$, $C_{\text{L_VOUT}} = 6\text{ nF}$, $C_{\text{BYPASS}} = 1\text{ }\mu\text{F}$, $\text{BW} = 450\text{ kHz}$	-	5	-	mV _{RMS}
Power Supply Sensitivity Error	$E_{\text{SENS_PS}}$	$V_{\text{DD(MIN)}}$ to $V_{\text{DD(MAX)}}$	-1.4	± 1	1.4	%
Power Supply Quiescent Voltage Output Error	$V_{\text{QVO_PS}}$	$V_{\text{DD(MIN)}}$ to $V_{\text{DD(MAX)}}$	-6	± 2	6	mV
Power Supply Reference Voltage Output Error	$V_{\text{REF_PS}}$	$V_{\text{DD(MIN)}}$ to $V_{\text{DD(MAX)}}$	-6	± 2	6	mV
Power Supply Offset Error	$V_{\text{OE_PS}}$	$V_{\text{DD(MIN)}}$ to $V_{\text{DD(MAX)}}$	-6	± 2	6	mV
ERROR COMPONENTS INCLUDING LIFETIME DRIFT ^{[2][3]}						
Sensitivity Error Including Lifetime Drift	$E_{\text{SENS_LTD}}$	$I_{\text{P}} = 0.5 \times I_{\text{PR(MAX)}}$, $T_A = 25^\circ\text{C}$ to 150°C	-	± 1.3	-	%
		$I_{\text{P}} = 0.5 \times I_{\text{PR(MAX)}}$, $T_A = -40^\circ\text{C}$ to 25°C	-	± 1.3	-	%
Quiescent Voltage Output Error Including Lifetime Drift	$V_{\text{QVO_LTD}}$	$I_{\text{P}} = 0\text{ A}$, $T_A = 25^\circ\text{C}$ to 150°C	-	± 2.7	-	mV
		$I_{\text{P}} = 0\text{ A}$, $T_A = -40^\circ\text{C}$ to 25°C	-	± 2.7	-	mV
Reference Voltage Output Error Including Lifetime Drift	$V_{\text{REF_LTD}}$	$T_A = 25^\circ\text{C}$ to 150°C	-	± 3.5	-	mV
		$T_A = -40^\circ\text{C}$ to 25°C	-	± 3.5	-	mV
Offset Error Including Lifetime Drift	$V_{\text{OE_LTD}}$	$I_{\text{P}} = 0\text{ A}$, $T_A = 25^\circ\text{C}$ to 150°C	-	± 1.4	-	mV
		$I_{\text{P}} = 0\text{ A}$, $T_A = -40^\circ\text{C}$ to 25°C	-	± 1.4	-	mV

^[1] Typical values are the mean ± 3 sigma of production distributions.

^[2] Validated by design and characterization.

^[3] Lifetime drift characteristics are based on the AEC-Q100 qualification results from zero-hour reads. Typical values are the worst-case mean drift observed during AEC-Q100 qualification from any of the -40°C , 25°C , or 150°C temperatures.

ACS37010 and ACS37012

450 kHz, High Accuracy Current Sensor With FAULT or Reference Output

ACS37012LLCTR-010B5 PERFORMANCE CHARACTERISTICS: Valid over full operating temperature range, $T_A = -40^\circ\text{C}$ to 150°C , $C_{\text{BYPASS}} = 100\text{ nF}$, and $V_{\text{DD}} = 3.3\text{ V}$, unless otherwise specified

Characteristic	Symbol	Test Conditions	Min.	Typ. ^[1]	Max.	Units
NOMINAL PERFORMANCE						
Current Sensing Range ^[2]	I_{PR}	Limited by $T_{\text{J(MAX)}} = 165^\circ\text{C}$	-10	-	10	A
Sensitivity	Sens	$I_{\text{PR(MIN)}} < I_{\text{P}} < I_{\text{PR(MAX)}}$	-	200	-	mV/A
Quiescent Voltage Output	V_{QVO}	$I_{\text{P}} = 0\text{ A}$	-	2.5	-	V
Overcurrent FAULT Threshold	I_{OC}		-	100	-	% I_{PR}
Overcurrent FAULT Hysteresis	$I_{\text{OC_HYS}}$		-	0.95	-	A
FAULT ERROR						
Overcurrent Error	$I_{\text{OC_E}}$		-1	-	1	A
ERROR COMPONENTS						
Sensitivity Error	E_{SENS}	$I_{\text{P}} = 0.5 \times I_{\text{PR(MAX)}}$, $T_A = 25^\circ\text{C}$ to 150°C	-1.5	± 1	1.5	%
		$I_{\text{P}} = 0.5 \times I_{\text{PR(MAX)}}$, $T_A = -40^\circ\text{C}$ to 25°C	-1.5	± 1	1.5	%
Quiescent Voltage Output Error	$V_{\text{QVO_E}}$	$I_{\text{P}} = 0\text{ A}$, $T_A = 25^\circ\text{C}$ to 150°C	-8	± 3	8	mV
		$I_{\text{P}} = 0\text{ A}$, $T_A = -40^\circ\text{C}$ to 25°C	-8	± 3	8	mV
Noise	N	$T_A = 25^\circ\text{C}$, $C_{\text{L_VOUT}} = 6\text{ nF}$, $C_{\text{BYPASS}} = 1\text{ }\mu\text{F}$, $\text{BW} = 450\text{ kHz}$	-	12	-	mV_{RMS}
Power Supply Sensitivity Error	$E_{\text{SENS_PS}}$	$V_{\text{DD(MIN)}}$ to $V_{\text{DD(MAX)}}$	-1.2	± 0.7	1.2	%
Power Supply Quiescent Voltage Output Error	$V_{\text{QVO_PS}}$	$V_{\text{DD(MIN)}}$ to $V_{\text{DD(MAX)}}$	-9	± 4	9	mV
ERROR COMPONENTS INCLUDING LIFETIME DRIFT ^{[2][3]}						
Sensitivity Error Including Lifetime Drift	$E_{\text{SENS_LTD}}$	$I_{\text{P}} = 0.5 \times I_{\text{PR(MAX)}}$, $T_A = 25^\circ\text{C}$ to 150°C	-	± 1.3	-	%
		$I_{\text{P}} = 0.5 \times I_{\text{PR(MAX)}}$, $T_A = -40^\circ\text{C}$ to 25°C	-	± 1.3	-	%
Quiescent Voltage Output Error Including Lifetime Drift	$V_{\text{QVO_LTD}}$	$I_{\text{P}} = 0\text{ A}$, $T_A = 25^\circ\text{C}$ to 150°C	-	± 2.7	-	mV
		$I_{\text{P}} = 0\text{ A}$, $T_A = -40^\circ\text{C}$ to 25°C	-	± 2.7	-	mV

[1] Typical values are the mean ± 3 sigma of production distributions.

[2] Validated by design and characterization.

[3] Lifetime drift characteristics are based on the AEC-Q100 qualification results from zero-hour reads. Typical values are the worst-case mean drift observed during AEC-Q100 qualification from any of the -40°C , 25°C , or 150°C temperatures.

ACS37010 and ACS37012

450 kHz, High Accuracy Current Sensor With FAULT or Reference Output

ACS37012LLCTR-010B3 PERFORMANCE CHARACTERISTICS: Valid over full operating temperature range, $T_A = -40^\circ\text{C}$ to 150°C , $C_{\text{BYPASS}} = 100\text{ nF}$, and $V_{\text{DD}} = 3.3\text{ V}$, unless otherwise specified

Characteristic	Symbol	Test Conditions	Min.	Typ. ^[1]	Max.	Units
NOMINAL PERFORMANCE						
Current Sensing Range ^[2]	I_{PR}	Limited by $T_{\text{J(MAX)}} = 165^\circ\text{C}$	-10	-	10	A
Sensitivity	Sens	$I_{\text{PR(MIN)}} < I_{\text{P}} < I_{\text{PR(MAX)}}$	-	132	-	mV/A
Quiescent Voltage Output	V_{QVO}	$I_{\text{P}} = 0\text{ A}$	-	1.65	-	V
Overcurrent FAULT Threshold	I_{OC}		-	100	-	% I_{PR}
Overcurrent FAULT Hysteresis	$I_{\text{OC_HYS}}$		-	0.95	-	A
FAULT ERROR						
Overcurrent Error	$I_{\text{OC_E}}$		-1	-	1	A
ERROR COMPONENTS						
Sensitivity Error	E_{SENS}	$I_{\text{P}} = 0.5 \times I_{\text{PR(MAX)}}$, $T_A = 25^\circ\text{C}$ to 150°C	-1.5	± 1	1.5	%
		$I_{\text{P}} = 0.5 \times I_{\text{PR(MAX)}}$, $T_A = -40^\circ\text{C}$ to 25°C	-1.5	± 1	1.5	%
Quiescent Voltage Output Error	$V_{\text{QVO_E}}$	$I_{\text{P}} = 0\text{ A}$, $T_A = 25^\circ\text{C}$ to 150°C	-8	± 2	8	mV
		$I_{\text{P}} = 0\text{ A}$, $T_A = -40^\circ\text{C}$ to 25°C	-8	± 2	8	mV
Noise	N	$T_A = 25^\circ\text{C}$, $C_{\text{L_VOUT}} = 6\text{ nF}$, $C_{\text{BYPASS}} = 1\text{ }\mu\text{F}$, $\text{BW} = 450\text{ kHz}$	-	12	-	mV_{RMS}
Power Supply Sensitivity Error	$E_{\text{SENS_PS}}$	$V_{\text{DD(MIN)}}$ to $V_{\text{DD(MAX)}}$	-1.4	± 1	1.4	%
Power Supply Quiescent Voltage Output Error	$V_{\text{QVO_PS}}$	$V_{\text{DD(MIN)}}$ to $V_{\text{DD(MAX)}}$	-6	± 3	6	mV
ERROR COMPONENTS INCLUDING LIFETIME DRIFT ^{[2][3]}						
Sensitivity Error Including Lifetime Drift	$E_{\text{SENS_LTD}}$	$I_{\text{P}} = 0.5 \times I_{\text{PR(MAX)}}$, $T_A = 25^\circ\text{C}$ to 150°C	-	± 1.3	-	%
		$I_{\text{P}} = 0.5 \times I_{\text{PR(MAX)}}$, $T_A = -40^\circ\text{C}$ to 25°C	-	± 1.3	-	%
Quiescent Voltage Output Error Including Lifetime Drift	$V_{\text{QVO_LTD}}$	$I_{\text{P}} = 0\text{ A}$, $T_A = 25^\circ\text{C}$ to 150°C	-	± 2.7	-	mV
		$I_{\text{P}} = 0\text{ A}$, $T_A = -40^\circ\text{C}$ to 25°C	-	± 2.7	-	mV

[1] Typical values are the mean ± 3 sigma of production distributions.

[2] Validated by design and characterization.

[3] Lifetime drift characteristics are based on the AEC-Q100 qualification results from zero-hour reads. Typical values are the worst-case mean drift observed during AEC-Q100 qualification from any of the -40°C , 25°C , or 150°C temperatures.

ACS37010 and ACS37012

450 kHz, High Accuracy Current Sensor With FAULT or Reference Output

ACS37012LLCTR-050B5 PERFORMANCE CHARACTERISTICS: Valid over full operating temperature range, $T_A = -40^\circ\text{C}$ to 150°C , $C_{\text{BYPASS}} = 100\text{ nF}$, and $V_{\text{DD}} = 3.3\text{ V}$, unless otherwise specified

Characteristic	Symbol	Test Conditions	Min.	Typ. ^[1]	Max.	Units
NOMINAL PERFORMANCE						
Current Sensing Range ^[2]	I_{PR}	Limited by $T_{\text{J(MAX)}} = 165^\circ\text{C}$	-50	-	50	A
Sensitivity	Sens	$I_{\text{PR(MIN)}} < I_{\text{P}} < I_{\text{PR(MAX)}}$	-	26.4	-	mV/A
Quiescent Voltage Output	V_{QVO}	$I_{\text{P}} = 0\text{ A}$	-	2.5	-	V
Overcurrent FAULT Threshold	I_{OC}		-	100	-	% I_{PR}
Overcurrent FAULT Hysteresis	$I_{\text{OC_HYS}}$		-	4.8	-	A
FAULT ERROR						
Overcurrent Error	$I_{\text{OC_E}}$		-5	-	5	A
ERROR COMPONENTS						
Sensitivity Error	E_{SENS}	$I_{\text{P}} = 0.5 \times I_{\text{PR(MAX)}}$, $T_A = 25^\circ\text{C}$ to 150°C	-1.5	± 1	1.5	%
		$I_{\text{P}} = 0.5 \times I_{\text{PR(MAX)}}$, $T_A = -40^\circ\text{C}$ to 25°C	-1.5	± 1	1.5	%
Quiescent Voltage Output Error	$V_{\text{QVO_E}}$	$I_{\text{P}} = 0\text{ A}$, $T_A = 25^\circ\text{C}$ to 150°C	-8	± 2	8	mV
		$I_{\text{P}} = 0\text{ A}$, $T_A = -40^\circ\text{C}$ to 25°C	-8	± 2	8	mV
Noise	N	$T_A = 25^\circ\text{C}$, $C_{\text{L_VOUT}} = 6\text{ nF}$, $C_{\text{BYPASS}} = 1\text{ }\mu\text{F}$, $\text{BW} = 450\text{ kHz}$	-	5	-	mV_{RMS}
Power Supply Sensitivity Error	$E_{\text{SENS_PS}}$	$V_{\text{DD(MIN)}}$ to $V_{\text{DD(MAX)}}$	-1.4	± 1	1.4	%
Power Supply Quiescent Voltage Output Error	$V_{\text{QVO_PS}}$	$V_{\text{DD(MIN)}}$ to $V_{\text{DD(MAX)}}$	-6	± 2	6	mV
ERROR COMPONENTS INCLUDING LIFETIME DRIFT ^{[2][3]}						
Sensitivity Error Including Lifetime Drift	$E_{\text{SENS_LTD}}$	$I_{\text{P}} = 0.5 \times I_{\text{PR(MAX)}}$, $T_A = 25^\circ\text{C}$ to 150°C	-	± 1.3	-	%
		$I_{\text{P}} = 0.5 \times I_{\text{PR(MAX)}}$, $T_A = -40^\circ\text{C}$ to 25°C	-	± 1.3	-	%
Quiescent Voltage Output Error Including Lifetime Drift	$V_{\text{QVO_LTD}}$	$I_{\text{P}} = 0\text{ A}$, $T_A = 25^\circ\text{C}$ to 150°C	-	± 2.7	-	mV
		$I_{\text{P}} = 0\text{ A}$, $T_A = -40^\circ\text{C}$ to 25°C	-	± 2.7	-	mV

^[1] Typical values are the mean ± 3 sigma of production distributions.

^[2] Validated by design and characterization.

^[3] Lifetime drift characteristics are based on the AEC-Q100 qualification results from zero-hour reads. Typical values are the worst-case mean drift observed during AEC-Q100 qualification from any of the -40°C , 25°C , or 150°C temperatures.

ACS37010 and ACS37012

450 kHz, High Accuracy Current Sensor With FAULT or Reference Output

ACS37012LLCTR-050B3 PERFORMANCE CHARACTERISTICS: Valid over full operating temperature range, $T_A = -40^\circ\text{C}$ to 150°C , $C_{\text{BYPASS}} = 100\text{ nF}$, and $V_{\text{DD}} = 3.3\text{ V}$, unless otherwise specified

Characteristic	Symbol	Test Conditions	Min.	Typ. ^[1]	Max.	Units
NOMINAL PERFORMANCE						
Current Sensing Range ^[2]	I_{PR}	Limited by $T_{\text{J(MAX)}} = 165^\circ\text{C}$	-50	-	50	A
Sensitivity	Sens	$I_{\text{PR(MIN)}} < I_{\text{P}} < I_{\text{PR(MAX)}}$	-	26.4	-	mV/A
Quiescent Voltage Output	V_{QVO}	$I_{\text{P}} = 0\text{ A}$	-	1.65	-	V
Overcurrent FAULT Threshold	I_{OC}		-	100	-	% I_{PR}
Overcurrent FAULT Hysteresis	$I_{\text{OC_HYS}}$		-	4.8	-	A
FAULT ERROR						
Overcurrent Error	$I_{\text{OC_E}}$		-5	-	5	A
ERROR COMPONENTS						
Sensitivity Error	E_{SENS}	$I_{\text{P}} = 0.5 \times I_{\text{PR(MAX)}}$, $T_A = 25^\circ\text{C}$ to 150°C	-1.5	± 1	1.5	%
		$I_{\text{P}} = 0.5 \times I_{\text{PR(MAX)}}$, $T_A = -40^\circ\text{C}$ to 25°C	-1.5	± 1	1.5	%
Quiescent Voltage Output Error	$V_{\text{QVO_E}}$	$I_{\text{P}} = 0\text{ A}$, $T_A = 25^\circ\text{C}$ to 150°C	-8	± 2	8	mV
		$I_{\text{P}} = 0\text{ A}$, $T_A = -40^\circ\text{C}$ to 25°C	-8	± 2	8	mV
Noise	N	$T_A = 25^\circ\text{C}$, $C_{\text{L_VOUT}} = 6\text{ nF}$, $C_{\text{BYPASS}} = 1\text{ }\mu\text{F}$, $\text{BW} = 450\text{ kHz}$	-	5	-	mV_{RMS}
Power Supply Sensitivity Error	$E_{\text{SENS_PS}}$	$V_{\text{DD(MIN)}}$ to $V_{\text{DD(MAX)}}$	-1.4	± 1	1.4	%
Power Supply Quiescent Voltage Output Error	$V_{\text{QVO_PS}}$	$V_{\text{DD(MIN)}}$ to $V_{\text{DD(MAX)}}$	-6	± 2	6	mV
ERROR COMPONENTS INCLUDING LIFETIME DRIFT ^{[2][3]}						
Sensitivity Error Including Lifetime Drift	$E_{\text{SENS_LTD}}$	$I_{\text{P}} = 0.5 \times I_{\text{PR(MAX)}}$, $T_A = 25^\circ\text{C}$ to 150°C	-	± 1.3	-	%
		$I_{\text{P}} = 0.5 \times I_{\text{PR(MAX)}}$, $T_A = -40^\circ\text{C}$ to 25°C	-	± 1.3	-	%
Quiescent Voltage Output Error Including Lifetime Drift	$V_{\text{QVO_LTD}}$	$I_{\text{P}} = 0\text{ A}$, $T_A = 25^\circ\text{C}$ to 150°C	-	± 2.7	-	mV
		$I_{\text{P}} = 0\text{ A}$, $T_A = -40^\circ\text{C}$ to 25°C	-	± 2.7	-	mV

^[1] Typical values are the mean ± 3 sigma of production distributions.

^[2] Validated by design and characterization.

^[3] Lifetime drift characteristics are based on the AEC-Q100 qualification results from zero-hour reads. Typical values are the worst-case mean drift observed during AEC-Q100 qualification from any of the -40°C , 25°C , or 150°C temperatures.

CHARACTERISTIC PERFORMANCE

ACS37010 and ACS37012 Typical Frequency Response

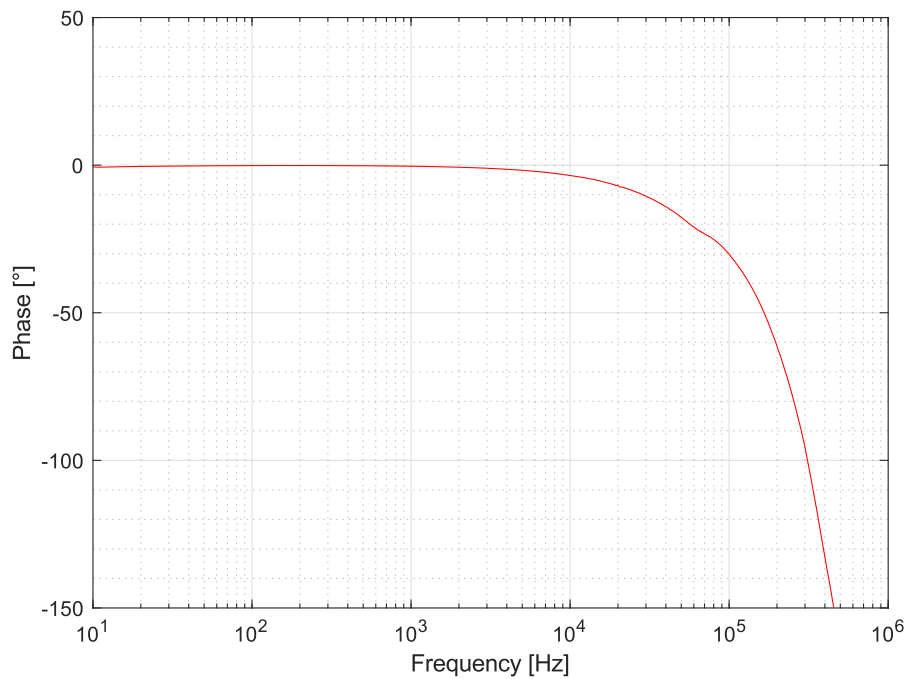
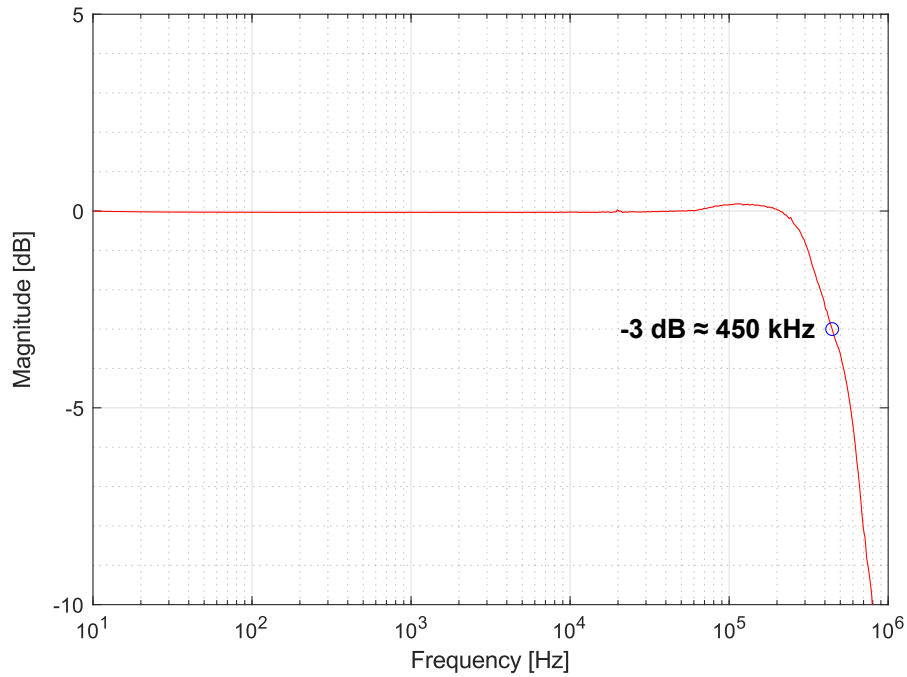

RESPONSE CHARACTERISTICS DEFINITIONS AND TYPICAL PERFORMANCE DATA

Response Time (t_{RESPONSE})

The time interval between a) when the sensed input current reaches 90% of its final value, and b) when the sensor output reaches 90% of its full-scale value.

Propagation Delay (t_{pd})

The time interval between a) when the sensed input current reaches 20% of its full-scale value, and b) when the sensor output reaches 20% of its full-scale value.

Rise Time (t_r)

The time interval between a) when the sensor reaches 10% of its full-scale value, and b) when the sensor reaches 90% of its full-scale value.

Output Slew Rate (SR)

The rate of change [$\text{V}/\mu\text{s}$] in the output voltage between a) when the sensor reaches 10% of its full-scale value, and b) when the sensor reaches 90% of its full-scale value.

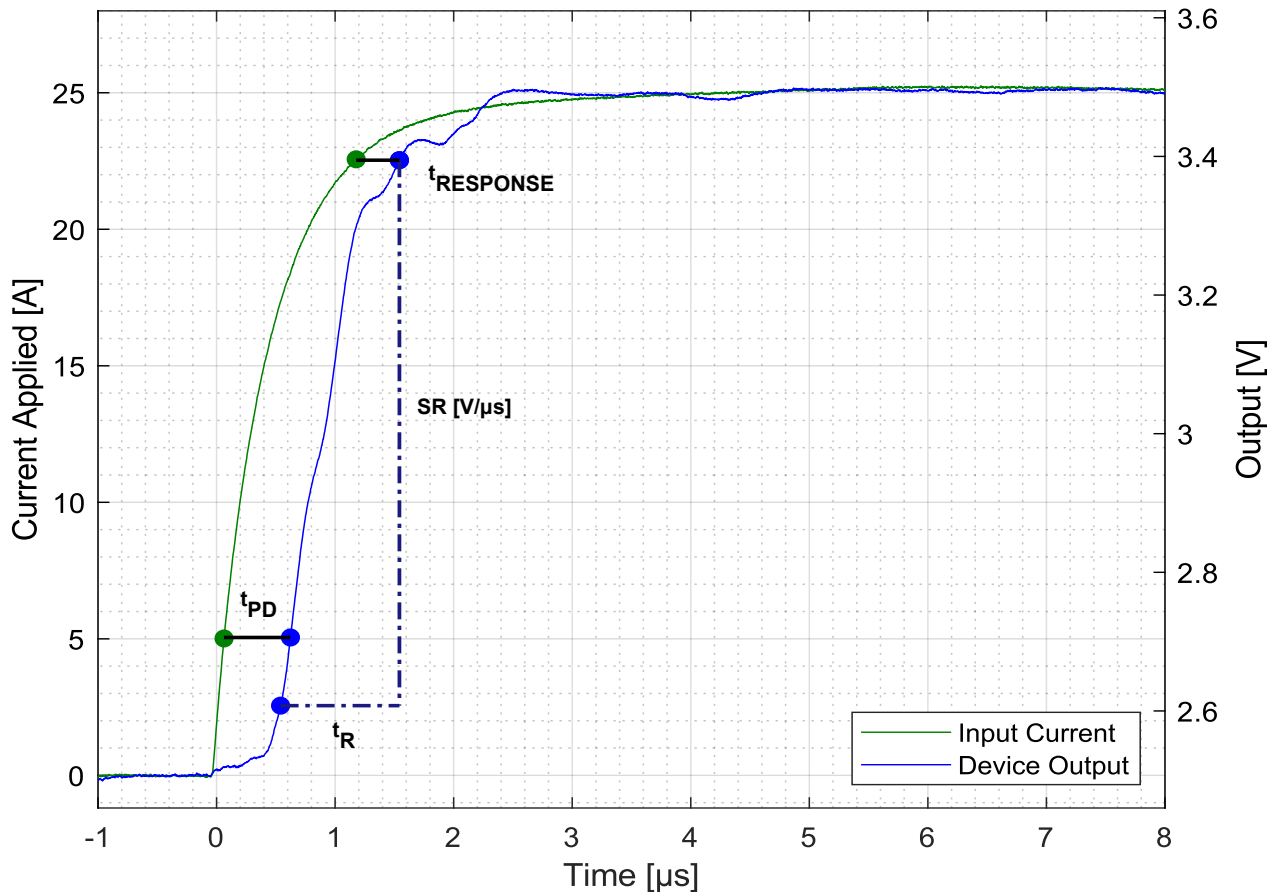

Applied current step with 10% to 90% rise time = 1 μs
Test Conditions: $T_A = 25^\circ\text{C}$, $C_{\text{BYPASS}} = 1 \mu\text{F}$, $C_{\text{L_VOUT}} = 6 \text{ nF}$

Figure 4: Response Time, Propagation Delay, Rise Time, and Output Slew Rate

FUNCTIONAL DESCRIPTION OF POWER ON/OFF OPERATION

Introduction

To ensure that the device output is reporting accurately, the ACS37010/12 contains an overvoltage and an undervoltage detection flag. This internal flag on V_{OUT} can be used to alert the system when the supply voltage for the device is beyond the operational range by putting the output into a known high-impedance (high Z) state. UVD is only active on 5 V devices.

V_{OUT} is plotted moving with V_{DD} in Figure 5 through Figure 10. During a high-impedance state, the voltage of V_{OUT} is most consistent with a known load (R_{L_VOUT} , C_{L_VOUT}). The plots in this section all use the same labeling scheme for different power thresholds, and references in brackets “[]” are valid for each of these plots.

NOTE: Any mention of V_{REF} applies to ACS37010 only.

POWER-ON OPERATION

UVD Enabled

When UVD is enabled, as V_{DD} ramps up, the ACS37010 V_{OUT} and V_{REF} pins are high Z until V_{DD} reaches and exceeds V_{UVD} [2] and V_{POR} [1], respectively. Once V_{DD} exceeds these thresholds, before the device can enter the typical operation mode, the device requires a period of time where V_{DD} does not reduce to less than $V_{POR} - V_{POR_HYS}$ [8].

UVD Disabled

When UVD is disabled, as V_{DD} ramps up, the ACS37010 V_{OUT} and V_{REF} pins are high Z until V_{DD} reaches and exceeds V_{POR} [1]. Once V_{DD} exceeds V_{POR} [1], V_{OUT} enters typical operation.

POWER-OFF OPERATION

UVD Enabled

When UVD is enabled, before the device powers off, if V_{DD} reaches less than $V_{UVD} - V_{UVD_HYS}$ [6], V_{OUT} is forced to GND. When $V_{POR} - V_{POR_HYS}$ [8] is reached, V_{OUT} and V_{REF} become high Z.

UVD Disabled

When UVD is disabled, V_{REF} and V_{OUT} continue to report until V_{DD} is less than $V_{POR} - V_{POR_HYS}$ [8], at which point, V_{OUT} and V_{REF} enter a high Z state.

NOTE: Because the device is entering a high Z state and is not driving the output, the time required for the output to reach a steady state depends on the external circuitry.

Voltage Thresholds

POWER-ON RESET RELEASE VOLTAGE (V_{POR})

If V_{DD} reduces to less than $V_{POR} - V_{POR_HYS}$ [8] while in operation, the digital circuitry turns off and the output re-enters a high Z state. After V_{DD} recovers and exceeds V_{UVD} [2], a delay of t_{PO} occurs, then the output begins to report again.

UNDERVOLTAGE DETECTION THRESHOLD (V_{UVD})

The 5 V devices are factory-programmed with UVD enabled. It is important to note that, after a power-on-reset event, upon initial device power-up, V_{OUT} and V_{REF} remain high Z until V_{DD} increases to greater than V_{UVD} [2] and V_{POR} [1] respectively, at which point the V_{OUT} and V_{REF} outputs begin to resume typical operation. For 3.3 V device variants used in the same condition, if UVD is disabled, after V_{DD} increases to greater than V_{POR} [1], V_{OUT} and V_{REF} begin typical operation.

After typical operation begins, if V_{DD} reduces to less than $V_{UVD} - V_{UVD_HYS}$ [6], V_{OUT} pulls to GND regardless of R_{L_VOUT} configuration. The V_{OUT} remains at GND until V_{DD} increases to greater than V_{UVD} [1] or V_{DD} reduces to less than $V_{POR} - V_{POR_HYS}$ [8]. After a UVD event, if V_{DD} increases to greater than V_{UVD} [1], the V_{OUT} and V_{REF} outputs resume operation. If V_{DD} reduces to less than $V_{POR} - V_{POR_HYS}$ [8], the device enters a POR event and resets; if this occurs, V_{OUT} and V_{REF} switch to high Z.

OVERVOLTAGE DETECTION THRESHOLD (V_{OVD})

When V_{DD} increases to greater than V_{OVD} [4], the output of the V_{OUT} pin becomes high Z, V_{REF} remains in typical operation, and V_{OUT} becomes pulled to either VDD or GND, depending on the configuration (pull-up vs. pull-down) of R_{L_VOUT} .

OVERVOLTAGE/UNDERVOLTAGE DETECTION HYSTERESIS (V_{OVD_HYS} , V_{UVD_HYS})

To reduce nuisance flagging and clears, hysteresis is present between enable and disable thresholds.

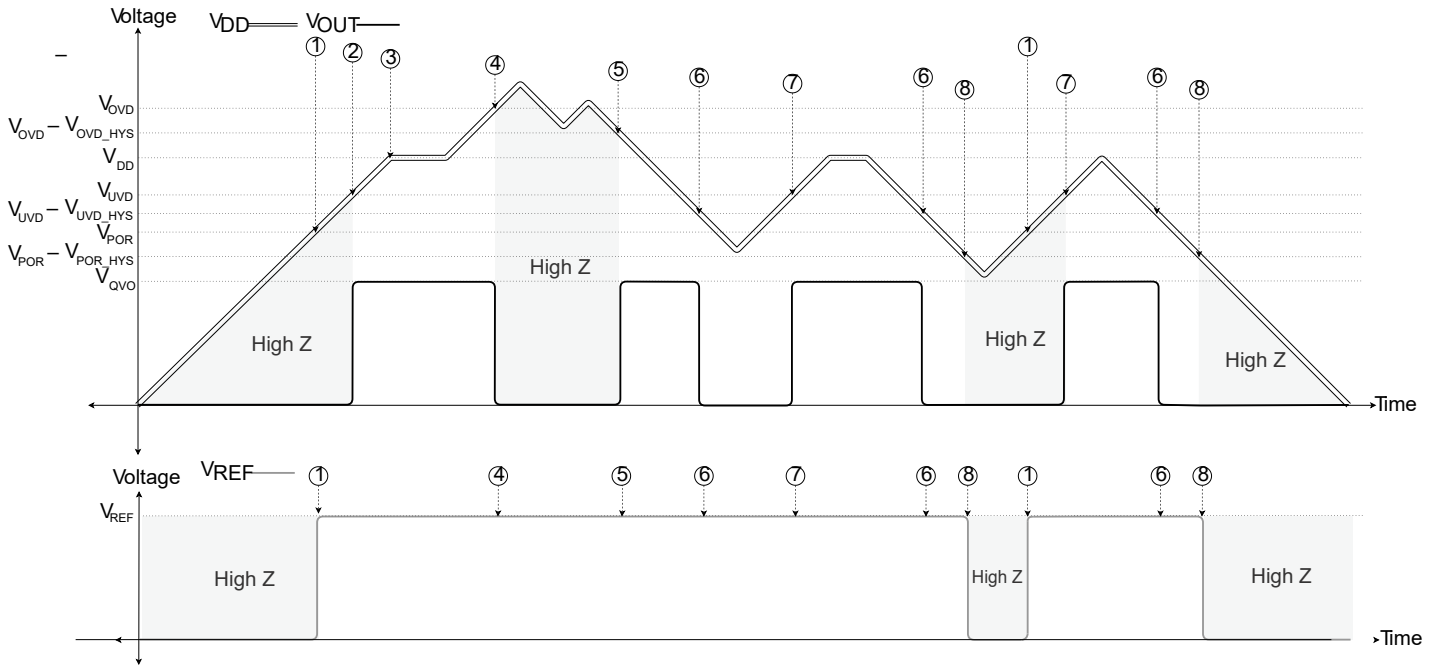

Figure 5: Power-State Thresholds with V_{OUT} and V_{REF} Behavior for a 5 V Device, R_{L_VOUT} = Pull-Down, UVD Enabled

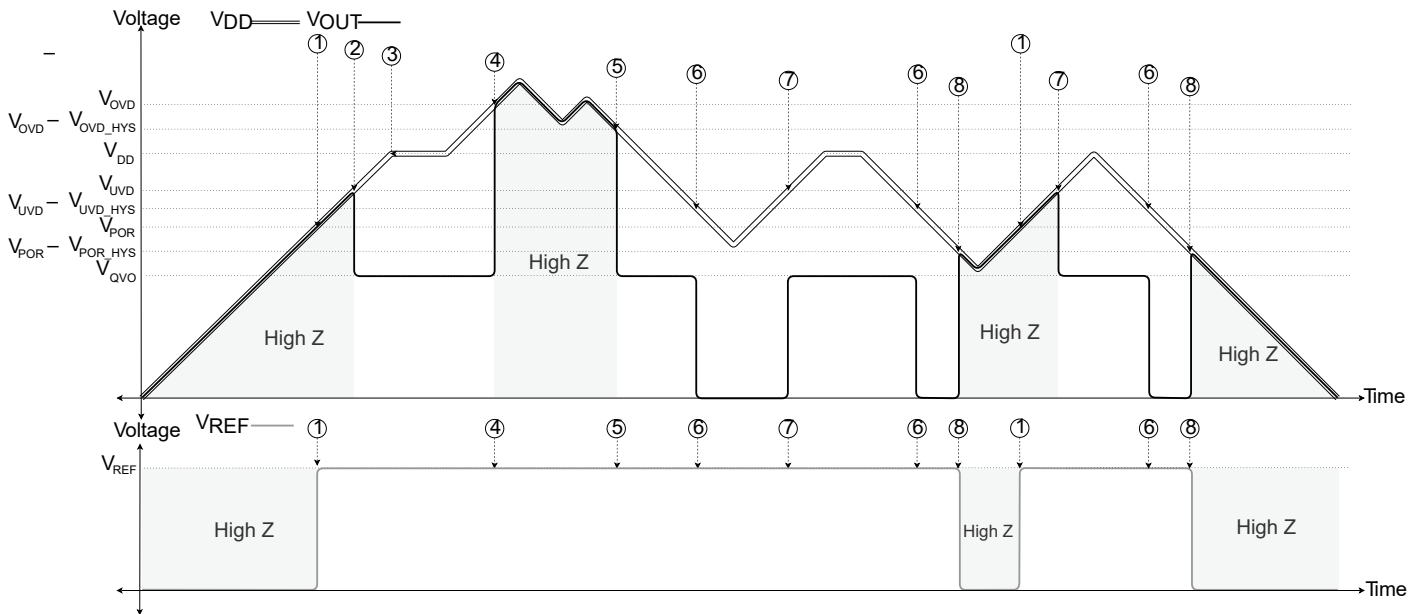

Figure 6: Power-State Thresholds with V_{OUT} and V_{REF} Behavior, 5 V Device, R_{L_VOUT} = Pull-Up, UVD Enabled

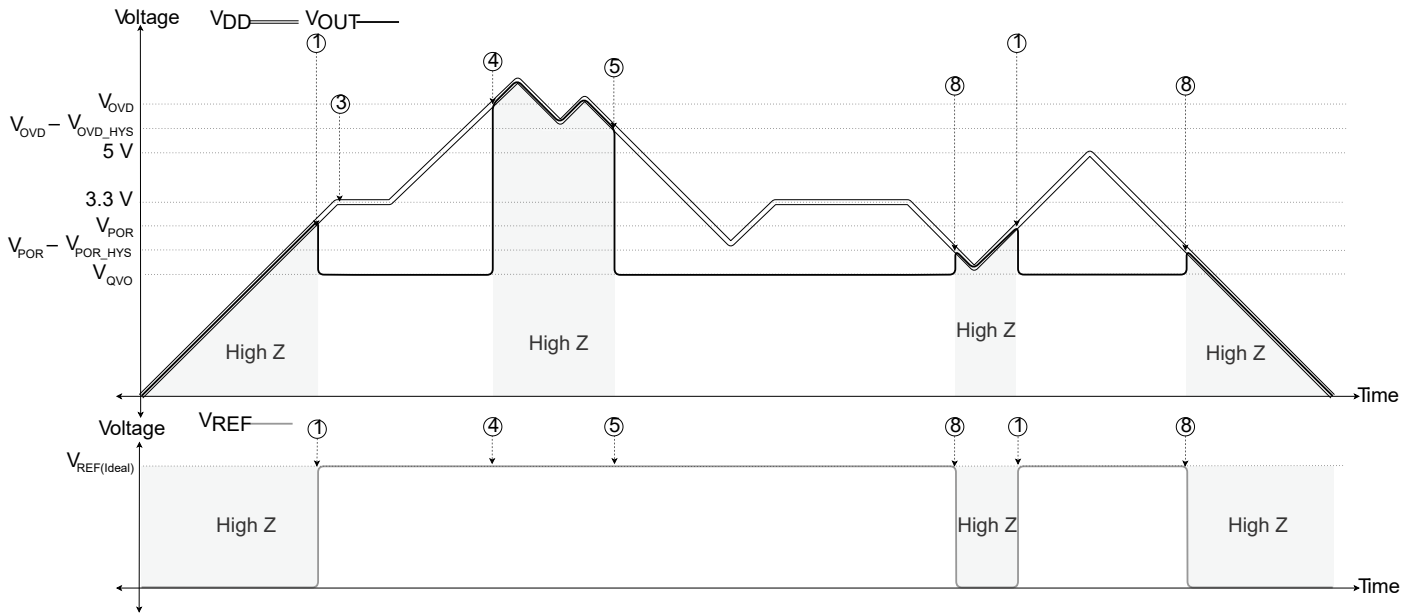

Figure 7: Power-State Thresholds with V_{OUT} and V_{REF} Behavior, 3.3 V Device, R_L = Pull-Up, UVD Disabled

Timing Thresholds

POWER-ON DELAY (t_{PO})

When the supply is ramped to V_{UVD} [2], the device requires a finite period of time to power its internal components before the outputs are released from high Z and can respond to an input magnetic field. Power-on time, t_{PO} , is defined as the time it takes for the output voltage to settle within $\pm 10\%$ of its steady-state value under an applied magnetic field, which can be observed as the time from [2] to [A] in Figure 8. After this delay, the output quickly approaches $V_{OUT(IP)} = Sens \times I_p + V_{REF}$.

**OVERVOLTAGE AND UNDERVOLTAGE DETECTION
TIME AND DETECTION RELEASE TIME**

(t_{OVD}/t_{OVD_R} , t_{UVD}/t_{UVD_R})

The enable time for OVD, t_{OVD} , is the time from V_{OVD} [4] to OVD flag [B]. The UVD enable time, t_{UVD} , is the time from $V_{UVD} - V_{UVD_HYS}$ [6] to the UVD flag [D].

If V_{DD} ramps from greater than $V_{UVD} - V_{UVD_HYS}$ [6] to less than $V_{POR} - V_{POR_HYS}$ [8] faster than t_{UVD} , the device does not have time to report a UVD event before power-off occurs.

The detection release time for OVD, t_{OVD_R} , is the time from $V_{OVD} - V_{OVD_HYS}$ [5] to the OVD clear to typical operation [C]. The UVD disable time, t_{UVD_R} , is the time from V_{UVD} [7] to the point that the UVD flag clears and V_{OUT} returns to nominal operation [E]. The disable time does not have a counter for either OVD or UVD to release the output and resume reporting.

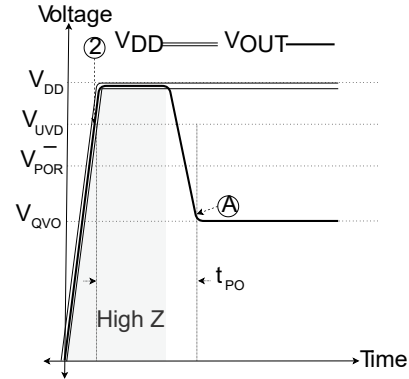

Figure 8: t_{PO} Behavior UVD Enabled, $R_{L_VOUT} =$ Pull-Up

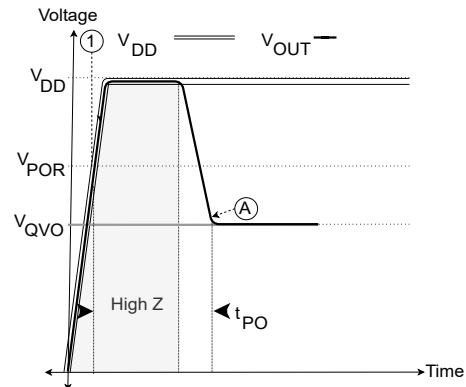

Figure 9: t_{PO} Behavior UVD Disabled, $R_{L_VOUT} =$ Pull-Up

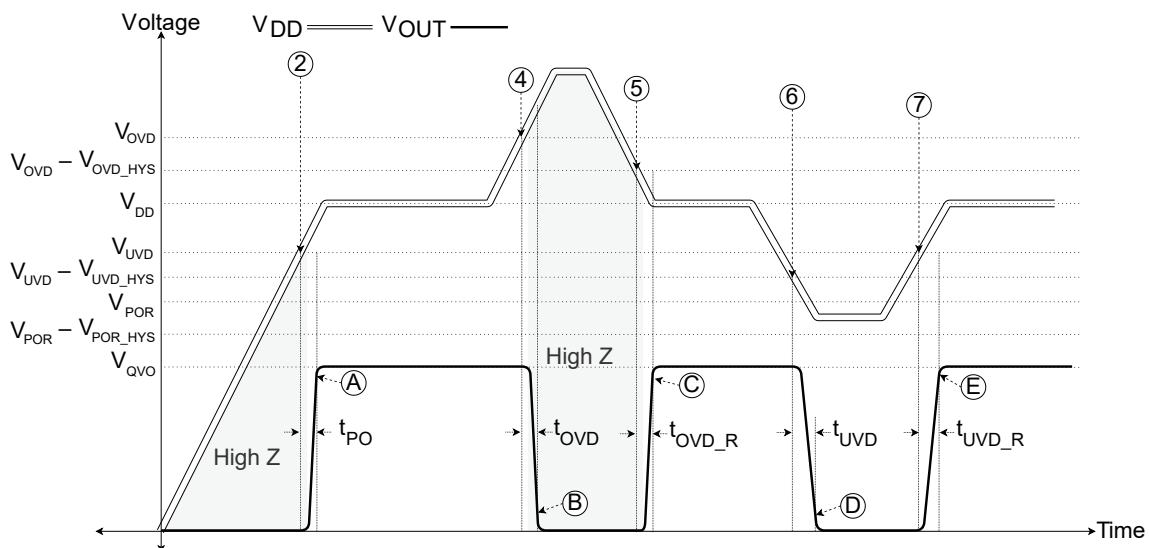

Figure 10: t_{PO} , and t_{OVD}/t_{OVD_R} , and t_{UVD}/t_{UVD_R} with $R_{L_VOUT} =$ Pull-Up

DEFINITIONS OF OPERATING AND PERFORMANCE CHARACTERISTICS

Quiescent Voltage Output (V_{QVO})

Quiescent voltage output, V_{QVO} , is defined as the voltage on the output, V_{OUT} , when zero amperes are applied through I_P .

Quiescent Voltage Output Error (V_{QVO_E})

Quiescent voltage output error, V_{QVO_E} , is defined as the drift of V_{QVO} from room to hot or room to cold (25°C to 150°C or 25°C to -40°C, respectively). To improve overtemperature performance, the temperature drift is compensated with Allegro factory trim to remain within the limits across temperature.

Reference Voltage Output (V_{REF})

The reference voltage output, V_{REF} , reports the quiescent voltage output for the output channel, V_{OUT} . The internally generated V_{REF} is used in a pseudo-differential mode to remove errors due to the reference shifts or noise on the ground line.

Reference Voltage Temperature Drift (V_{REF_E})

Reference voltage output error, V_{REF_E} , is defined as the drift of V_{REF} from room to hot or room to cold (25°C to 150°C or 25°C to -40°C, respectively).

Offset Error (V_{OE})

Offset error, V_{OE} , is defined as the difference between V_{QVO} and V_{REF} . V_{OE} includes $V_{QVO_E} - V_{REF}$ from room to hot or room to cold (25°C to 150°C or 25°C to -40°C, respectively).

Output Saturation Voltage (V_{SAT_H}/V_{SAT_L})

Output saturation voltage, V_{SAT} , is defined as the voltage that the V_{OUT} does not pass as a result of an increasing magnitude of current. V_{SAT_H} is the highest voltage the output can drive to, while V_{SAT_L} is the lowest. Note that changing the sensitivity does not change the V_{SAT} points.

Sensitivity (Sens)

Sensitivity, Sens, is the ratio of the output swing versus the applied current through the primary conductor, I_P . This current causes a voltage deviation away from V_{QVO} on the V_{OUT} output until V_{SAT} . The magnitude and direction of the output voltage swing is proportional to the magnitude and direction of the applied current. This proportional relationship between output and input is sensitivity and is defined as:

$$Sens = \frac{V_{OUT(IP_1)} - V_{OUT(IP_2)}}{IP_1 - IP_2}$$

where IP_1 and IP_2 are two different currents, and $V_{OUT(IP_1)}$ and $V_{OUT(IP_2)}$ are the voltages of the device at those respective applied currents.

Sensitivity Error (E_{SENS})

Sensitivity error, E_{SENS} , is the error of sensitivity from room to hot or room to cold (25°C to 150°C or 25°C to -40°C, respectively). Sensitivity error is compensated with Allegro factory trim.

Error Components Including Lifetime Drift ($E_{SENS_LTD}/V_{QVO_LTD}/V_{REF_LTD}/V_{OE_LTD}$)

Lifetime drift characteristics are based on a statistical combination of production distributions and worst-case distribution of parametric drift of individuals observed during AEC-Q100 qualification. Solder reflow induces stress on the ACS37010/12 device, causing parametric shifts; lifetime drift limits apply immediately after solder reflow, as well as after long-term use.

Power Supply Sensitivity Error (E_{SENS_PS})

Power supply sensitivity error, E_{SENS_PS} , is defined as the percent sensitivity error measured between V_{DD} and $V_{DD} \pm 10\%$. For a 5 V device, this is 5 to 4.5 V and 5 to 5.5 V. For a 3.3 V device, this is 3.3 to 3 V and 3.3 to 3.6 V.

Power Supply Offset Error (V_{OE_PS})

Power supply offset error, V_{OE_PS} , is defined as the offset error in mV between V_{DD} and $V_{DD} \pm 10\% V_{DD}$. For a 5 V device, this is 5 to 4.5 V and 5 to 5.5 V. For a 3.3 V device, this is 3.3 to 3 V and 3.3 to 3.6 V.

OVERCURRENT FAULT (OCF) BEHAVIOR

The overcurrent fault (OCF) function (ACS37012 only) pulls the open-drain FAULT pin low when the applied current exceeds a preset threshold (I_{OCR}). On the ACS37012, this threshold is internally set to 100% of the full-scale rated current. This flag trips symmetrically for positive and negative applied currents.

The implementation of the OCF circuitry is accurate over temperature and does not require further temperature compensation.

OVERCURRENT ERROR (I_{OC_E})

Overcurrent error, I_{OC_E} , is the error between the ideal I_{OC} and the measured I_{OC} .

OVERCURRENT HYSTERESIS (I_{OC_HYS})

Overcurrent hysteresis, I_{OC_HYS} , is defined as the magnitude of current in percentage of the full scale that must reduce before a fault assertion is cleared. This can be observed as the separation between voltages [9] to [10] in Figure 11.

OVERCURRENT FAULT RESPONSE TIME (t_{OC_RESP})

Overcurrent response time, t_{OC_RESP} is defined as the time from when the input reaches the operating point [9] until the OCF pin reduces to less than V_{FAULT_L} [G].

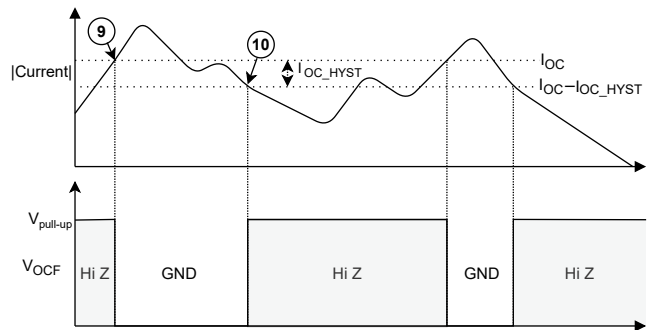

Figure 11: Fault Thresholds and OCF Pin Functionality

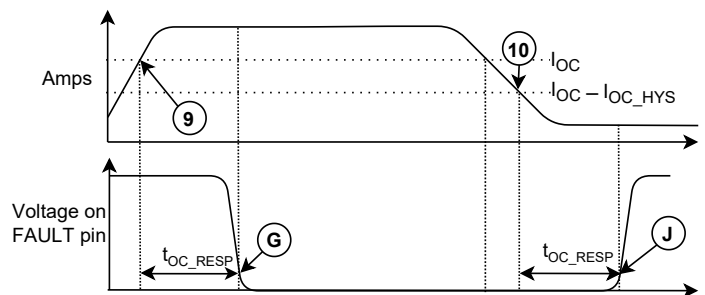

Figure 12: Fault Response Time

THERMAL PERFORMANCE

Thermal Rise vs. Primary Current

During the design of any current-sensing system, self-heating due to the flow of current in the package IP conductor should be considered. As current moves through the system, the sensor, printed circuit board (PCB), and contacts to the PCB generate heat and act as a heat sink.

The thermal response is highly dependent on PCB layout, copper thickness, cooling techniques, and profile of the injected current. The current profile includes peak current value, current on-time, and duty cycle.

Placing vias under the copper pads of the Allegro current sensor evaluation board minimizes the current-path resistance and improves heat-sinking to the PCB, while placing vias outside of the pads limits the current path to the top of the PCB trace and has worse heat-sinking under the part (see Figure 13 and Figure 14).

The measured rise in steady-state die temperature of the package versus DC continuous current at an ambient temperature, T_A , of 25°C for two board designs—filled vias placed under copper pads and vias not placed under copper pads (vias outside pad)—is shown for the LZ package in Figure 15 and Figure 16 for the LZ and LC packages, respectively.

The measured rise in steady-state die temperature of the package versus DC continuous current at an ambient temperature of 25°C and an ambient temperature of 125°C is shown in Figure 17 and Figure 18 for the LZ and LC packages, respectively. The evaluation boards used have filled vias under the copper pads. Use of in-pad vias results in better thermal performance than non-use of in-pad vias.

The thermal capacity of the ACS37010/12 in the LZ package should be verified by the end user in the application-specific conditions. The maximum junction temperature, $T_{J(max)}$ (165°C), should not be exceeded. Measuring the temperature of the top of the package is a close approximation of the die temperature.

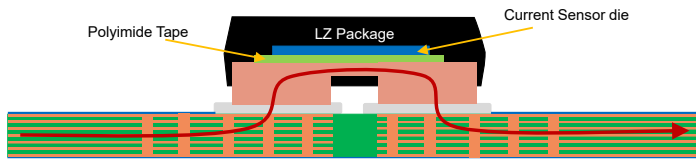

Figure 13: Vias Place Under Copper Pads, LZ Package

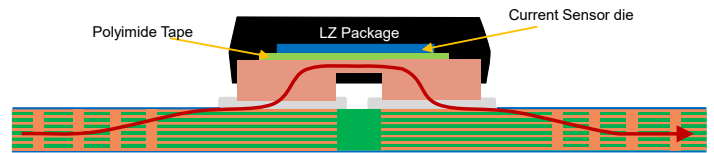
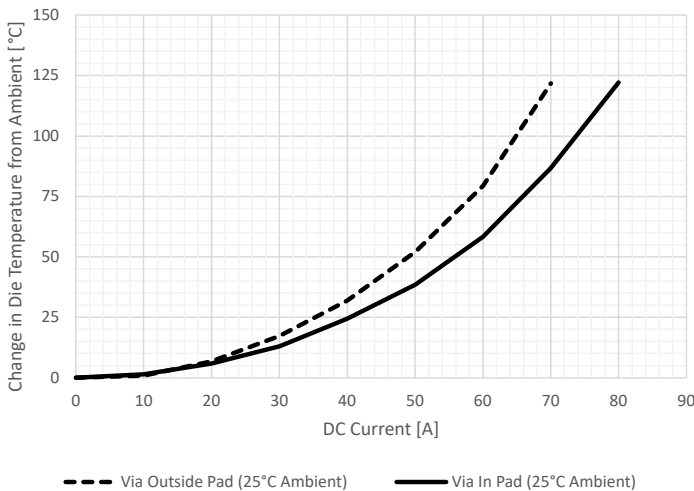

Figure 14: Vias Not Placed Under Copper Pads, LZ Package

LZ Package, Vias in Pad vs. Vias Outside Pad at 25°C



LC Package, Vias in Pad vs. Vias Outside Pad at 25°C

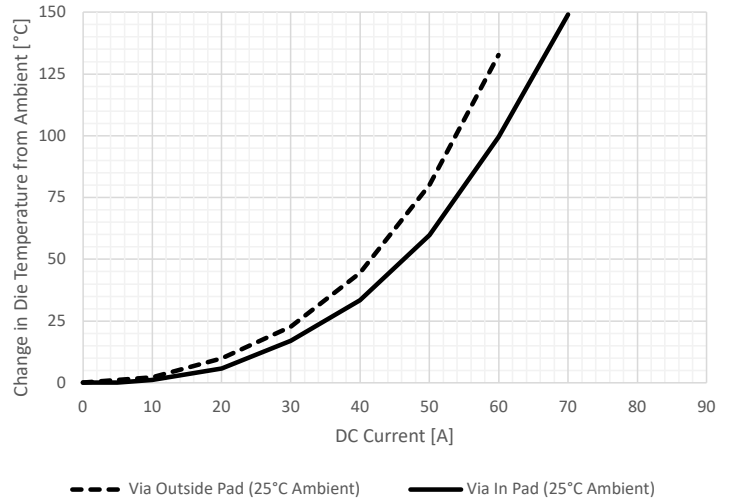

Figure 15: Comparison with and without In-Pad Vias at Ambient Temperature, LZ Package

Figure 16: Comparison with and without In-Pad Vias at Ambient Temperature, LC Package

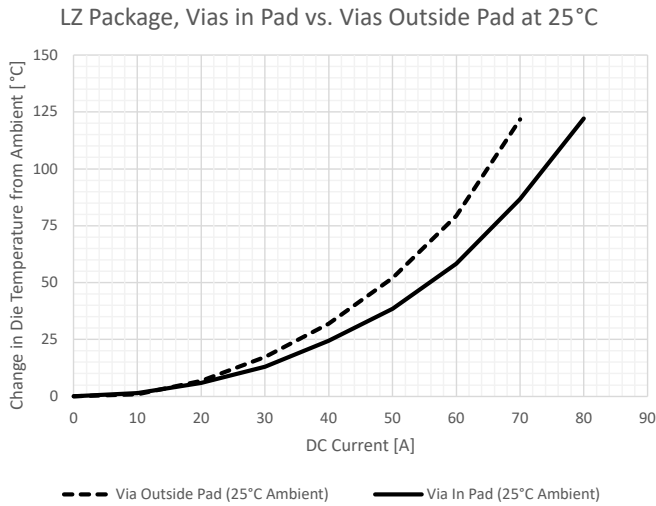

Figure 17: Comparison at 125°C and 25°C, In-Pad Vias, LZ Package

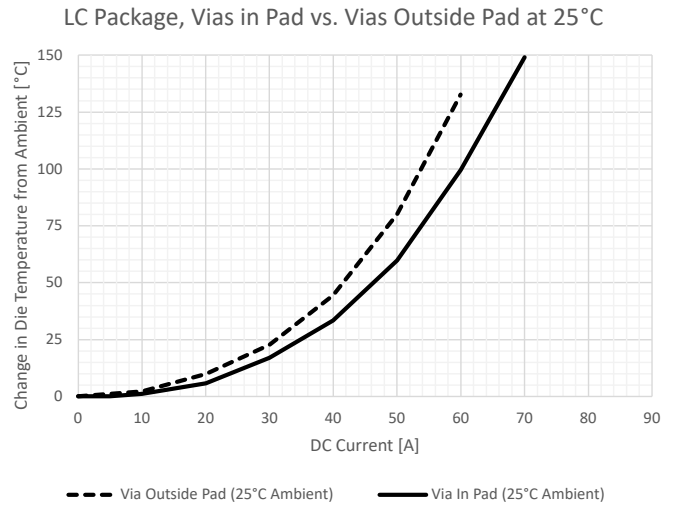

Figure 18: Comparison at 125°C and 25°C, In-Pad Vias, LC Package

Safe Operating Region

Current applied to the IP pins of the ACS37010/12 in the LZ package heats the package, as illustrated in the Thermal Rise vs. Primary Current section. The amount of heating depends on the current applied and duration. The range of applied current, and duration of current, that is not detrimental to the part is shown in Figure 19.

If enough energy is applied, the copper IP lead melts and the fuse opens. This condition is represented by the blue line, "Time to Fuse".

The maximum junction temperature is 165°C. If the maximum junction temperature is exceeded for an extended period of time the PN junctions on the die can become damaged. This condition can result in changes in the product performance, or it can create long-term reliability risks. The region in which this condition occurs is shown by the green line, "Time to 165°C".

The LZ package has a polyimide insulation barrier to enable high working voltages. Extended heating of the polyimide film causes deterioration of the material, reducing the insulation effectiveness of the package. This is shown by the red line, Time to Insulation Degradation.

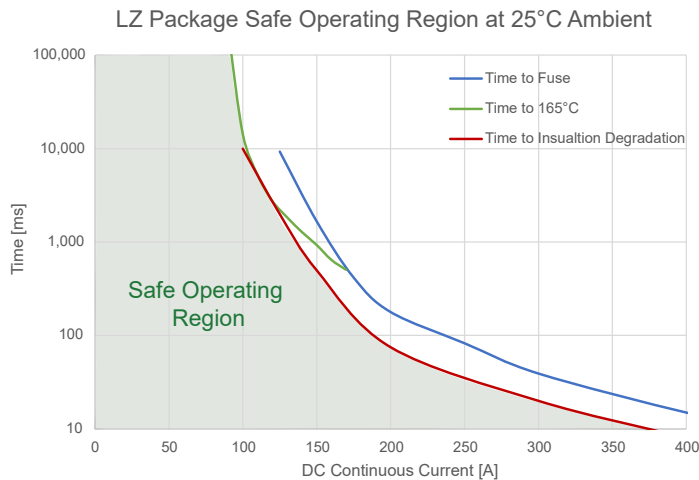

Figure 19: Safe Operating Region, LZ Package

Evaluation Board Layout

Thermal data shown in Figure 19 was collected using the LC/LZ Current Sensor Evaluation Board (ACSEVB-LC8-LZ6, TED-0004110). This board includes six layers and is shown in Figure 20.

Design support files for the ACSEVB-LC8-LZ6 evaluation board are available for download from the Allegro website. For more information, see the technical documents section of the ACS37010/12 webpage.

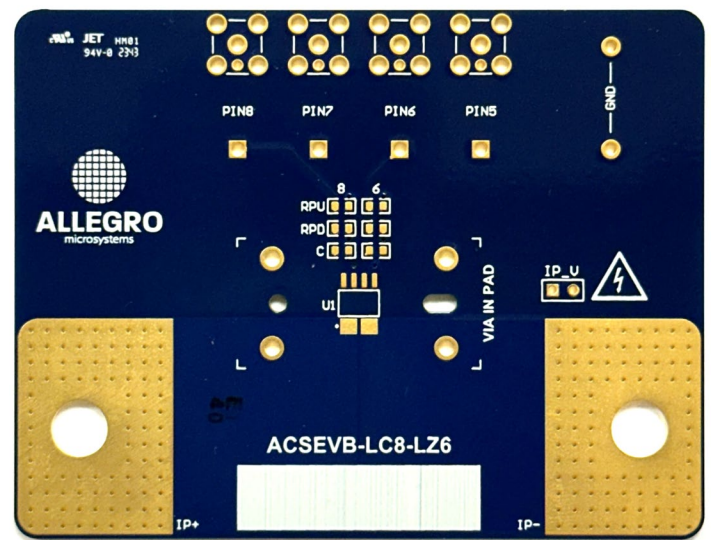

Figure 20: Allegro Evaluation Board, LZ or LC Package

PACKAGE OUTLINE DRAWING

For Reference Only – Not for Tooling Use

(Reference DWG-0000385, Rev. 1)

PRELIMINARY

NOT TO SCALE

Dimensions in millimeters

Dimensions exclusive of mold flash, gate burrs, and dambar protrusions
Exact case and lead configuration at supplier discretion within limits shown

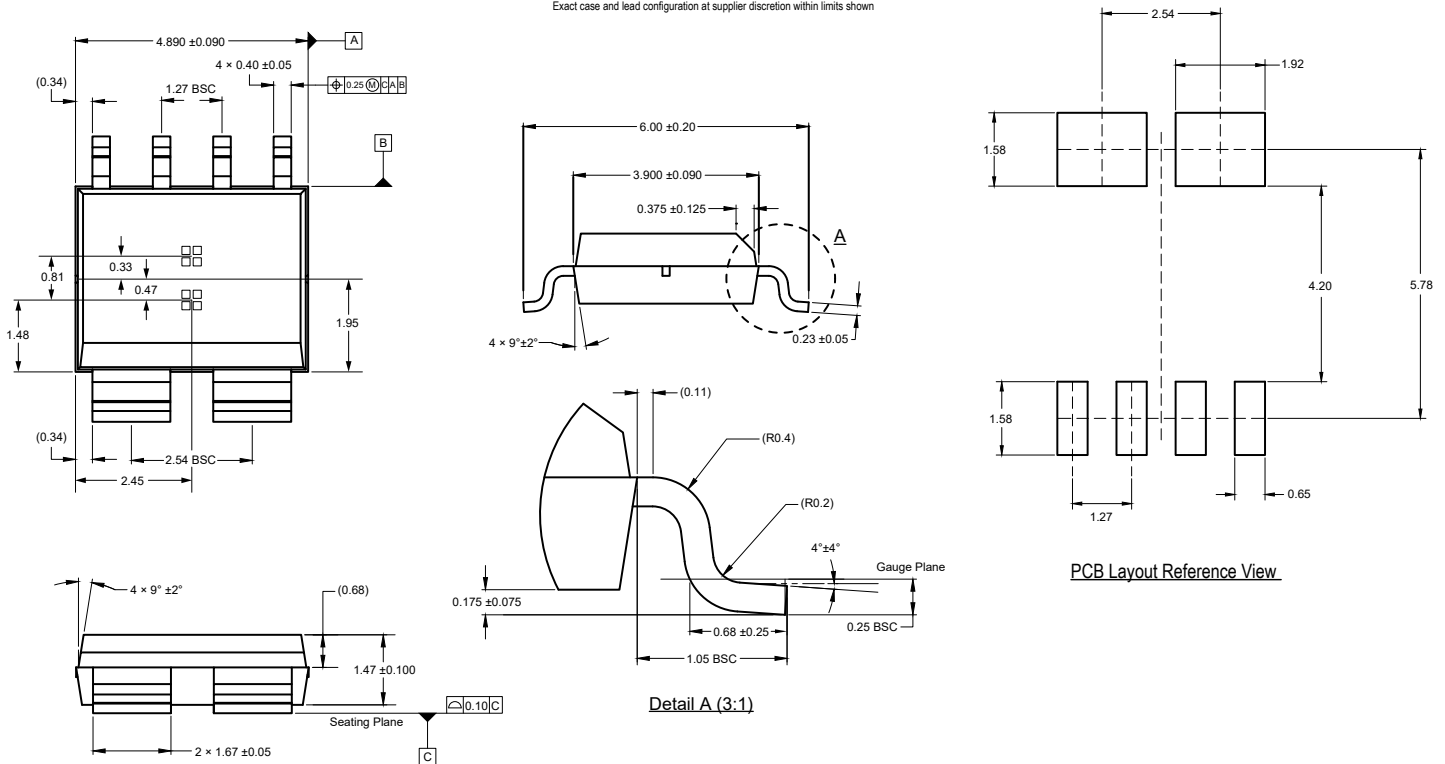
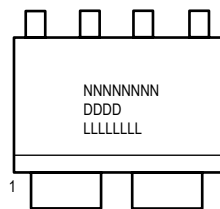

Figure 21: Custom 6-Pin SOIC (Suffix LZ)



Standard Branding Reference View

N = Device Part Number
D = Date Code
L = Assembly Lot Number

Figure 22: LZ Package, 6-Pin Fused-Lead SOIC

For Reference Only – Not for Tooling Use

(reference Allegro DWG-0000385, Rev. 2 or JEDEC MS-012AA)
Dimensions in millimeters – NOT TO SCALE
Dimensions exclusive of mold flash, gate burrs, and dambar protrusions
Exact case and lead configuration at supplier discretion within limits shown

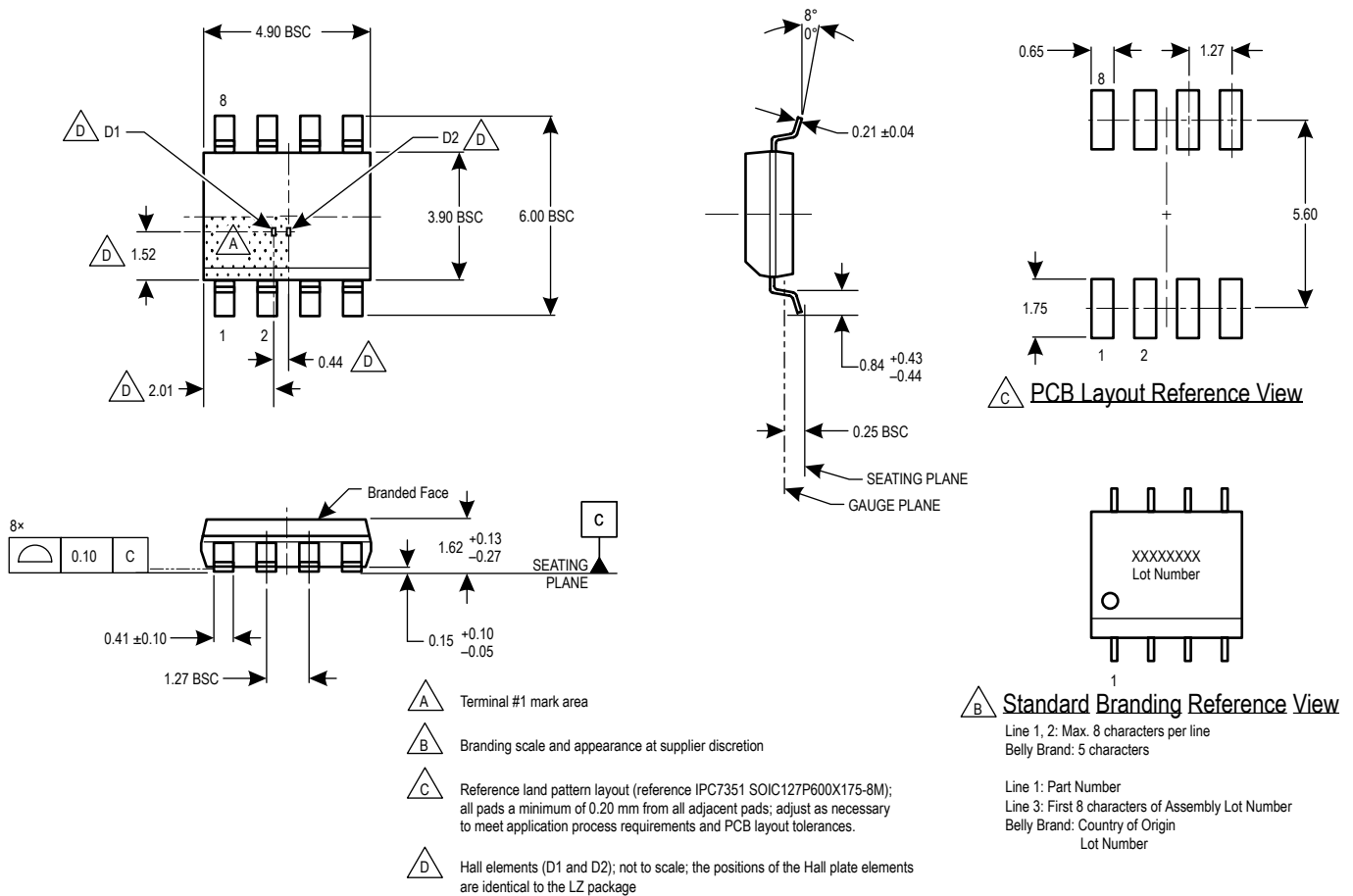

Figure 23: LC Package, 8-Pin SOIC

Revision History

Number	Date	Description
–	March 13, 2023	Initial release
1	March 29, 2023	Updated Error Components Including Lifetime Drift sections of Performance Characteristic tables (Pages 7, 8)
2	May 16, 2023	Added ACS37010LLZATR-030B5 and ACS37010LLZATR-030B3 part variants (all pages)
3	May 31, 2023	Added AEC-Q100 qualification to Features and Benefits (page 1)
4	November 9, 2023	Added ACS37012 variant
5	January 26, 2024	Added UL certification number (page 1), footnote 1, and Thermal Characteristics table (page 3); removed footnote 2 (page 3); corrected figure caption (page 5); updated Thermal Performance section (pages 24-25)
6	March 19, 2025	Minor editorial updates (all pages), added ACS37012LLZATR-030U5 part variant (page 2), improved isolation characteristics (page 3), corrected pinout and terminal list table (page 4), added footnotes [1] and [3] (page 7), added footnote [2] and clarified test conditions (page 8-15)
7	May 29, 2025	Updated Typical Application Circuit (page 1), Isolation Characteristics table (page 3)
8	November 18, 2025	Added LC package (throughout), added table of contents (page 2), updated selection table and part naming specification and changed internal conductor inductance characteristic (page 3), modified/ added output resistive/capacitive load characteristics (pages 7 and 8), and made minor editorial and formatting changes throughout.
9	February 3, 2026	Updated LC package part numbering throughout (pages 2, 3, 18–25), updated Selection Guide to add Features column (page 3), updated typical quiescent voltage output for ACS37010LLCTR-050B3 (page 21) and ACS37012LLCTR-050B5 (page 24), updated Power-on Operation and Undervoltage Threshold Detection subsections (page 28) and figures related to Power-State Thresholds with VOUT and VREF Behavior for a 5 V Device (page 29)

Copyright 2026, Allegro MicroSystems.

Allegro MicroSystems reserves the right to make, from time to time, such departures from the detail specifications as may be required to permit improvements in the performance, reliability, or manufacturability of its products. Before placing an order, the user is cautioned to verify that the information being relied upon is current.

Allegro’s products are not to be used in any devices or systems, including but not limited to life support devices or systems, in which a failure of Allegro’s product can reasonably be expected to cause bodily harm.

The information included herein is believed to be accurate and reliable. However, Allegro MicroSystems assumes no responsibility for its use; nor for any infringement of patents or other rights of third parties which may result from its use.

Copies of this document are considered uncontrolled documents.

For the latest version of this document, visit our website:

www.allegromicro.com

Looking for pricing, stock, or lifecycle information?

Click below to explore more details on WIN SOURCE:

- ⊖ [View ACS37010LLZATR-030B5 on WIN SOURCE](#)
- ⊖ [Allegro MicroSystems, LLC Information](#)

Optimize Your Supply Chain with WIN SOURCE Solutions

- ✓ Global Sourcing Solution
- ✓ Obsolete Management
- ✓ Cost Control Management
- ✓ Shortage Management
- ✓ Alternative Solution
- ✓ Excess Inventory Management