

XtremeSense™ TMR Current Sensor with Ultra-Low Noise and <1% Total Error

FEATURES AND BENEFITS

- Integrated contact current sensing for low to medium current ranges:
 - 0 to 20 A □ 0 to 50 A
 - ±20 A □ ±50 A
 - 0 to 30 A □ 0 to 65 A
 - ±30 A □ ±65 A
- Integrated current carrying conductor (CCC)
- Linear analog output voltage
- Total error output $\leq \pm 1.0\%$ FS
- 1 MHz bandwidth
- Response time: ~ 300 ns
- UL/IEC 62368-1 and UL1577 certification
 - Rated isolation voltage: $3.5 \text{ kV}_{\text{RMS}}$
 - Working voltage for basic isolation: $560 \text{ V}_{\text{RMS}}$
 - Working voltage for reinforced isolation: $280 \text{ V}_{\text{RMS}}$
- Low noise: 9.5 to $19.0 \text{ mA}_{\text{RMS}}$ @ $f_{\text{BW}} = 100 \text{ kHz}$
- Supply voltage: 3.0 to 3.6 V
- Filter function to reduce noise on output pin
- Immunity to common mode fields: -54 dB
- Overcurrent detection
 - Out of range currents
- AEC-Q100 grade 1
- 8-lead SOIC package

DESCRIPTION

The CT427 is a high bandwidth and ultra-low noise integrated contact current sensor that uses Allegro patented XtremeSense™ TMR technology to enable high accuracy current measurements for many industrial, consumer, and automotive applications. The device supports eight current ranges where the integrated current carrying conductor (CCC) will handle up to 65 A of current and generates a current measurement as a linear analog output voltage. The device achieves a total output error of less than $\pm 1.0\%$ full-scale (FS).

The device has a 300 ns output response time while the current consumption is $\sim 6.0 \text{ mA}$ and is immune to common mode fields. The CT427 has an integrated overcurrent detection (OCD) circuitry to identify out of range currents (OCD) with the result output to the fault-bar ($\overline{\text{FLT}}$) pin. The $\overline{\text{FLT}}$ is an open drain, active low digital signal that is activated by the CT427 to alert the microcontroller that a fault condition has occurred.

The CT427 is offered in an industry-standard 8-lead SOIC package that is green and RoHS compliant.

APPLICATIONS

- Solar/power inverters
- UPS, SMPS, and telecom power supplies
- Motor control
- Power utility meter
- Overcurrent fault protection

PACKAGE:

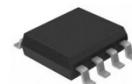

8-lead SOIC

Not to scale



TÜV Certificate No.:
R 72226133 0001



UL Certificate No.:
UL-CA-2201235-0

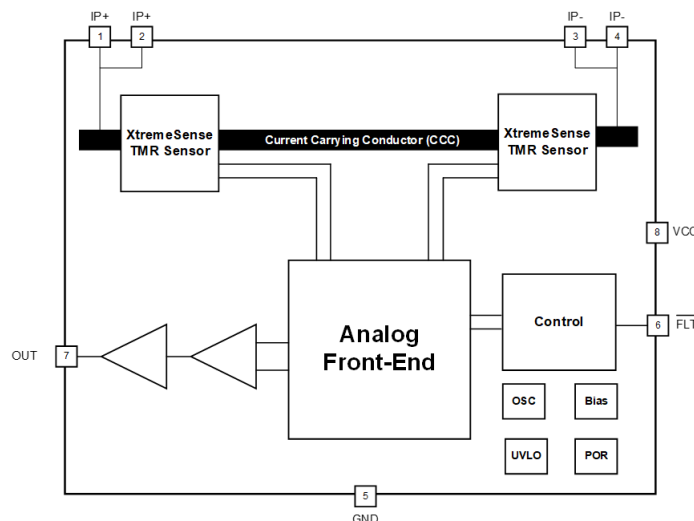

Figure 1: CT427 Functional Block Diagram for 8-lead SOIC Package

SELECTION GUIDE

Part Number	Current Range (I _P MAX) (A)	Sensitivity (mV/A)	Operating Temperature Range (°C)	Package	Packing
CT427-HSN820MR	±20	50	-40 to 125	8-lead SOIC 4.89 mm × 6.00 mm × 1.62 mm	Tape and Reel
CT427-HSN830MR	±30	33.3			
CT427-HSN850MR	±50	20			
CT427-HSN865MR	±65	15.4			
CT427-HSN820DR	20	100			
CT427-HSN830DR	30	66.7			
CT427-HSN850DR	50	40			
CT427-HSN865DR	65	30.8			
AEC-Q100 GRADE 1					
CT427-ASN820MR	±20	50	Grade 1 -40 to 125	8-lead SOIC 4.89 mm × 6.00 mm × 1.62 mm	Tape and Reel
CT427-ASN830MR	±30	33.3			
CT427-ASN850MR	±50	20			
CT427-ASN865MR	±65	15.4			
CT427-ASN820DR	20	100			
CT427-ASN830DR	30	66.7			
CT427-ASN850DR	50	40			
CT427-ASN865DR	65	30.8			

Table of Contents

Features and Benefits.....	1
Description	1
Applications.....	1
Package	1
Functional Block Diagram	1
Selection Guide	2
Evaluation Board Selection Guide	2
Absolute Maximum Ratings	3
Recommended Operating Conditions	3
Thermal Characteristics	3
Isolation Ratings	4
Application Diagram	4
Pinout Diagram and Terminal List.....	5
Electrical Characteristics	6
Functional Description	18
Package Outline Drawing.....	22
Tape and Reel Pocket Drawing and Dimensions	23
Package Information.....	24
Device Marking.....	25
Part Ordering Number Legend	25
Revision history	26

ABSOLUTE MAXIMUM RATINGS [1]

Characteristic	Symbol	Notes	Rating	Unit
Supply Voltage Strength	V_{CC}		-0.3 to 6.0	V
Analog Input/Output Pins Maximum Voltage	$V_{I/O}$		-0.3 to $V_{CC} + 0.3$ [2]	V
Current Carrying Conductor Maximum Current	$I_{CCC(MAX)}$	$T_A = 25^\circ\text{C}$	70	A
Dielectric Surge Strength Test Voltage	V_{SURGE}	IEC 61000-4-5: Tested ± 5 Pulses at 2/60 seconds, 1.2 μs (rise) and 50 μs (width)	6.0 (min)	kV
Surge Strength Test Current	I_{SURGE}	Tested ± 5 Pulses at 3/60 seconds, 8.0 μs (rise) and 20 μs (width)	3.0 (min)	kA
Electrostatic Discharge Protection Level	ESD	Human Body Model (HBM) per JESD22-A114	± 2.0	kV
		Charged Device Model (CDM) per JESD22-C101	± 0.5	kV
Junction Temperature	T_J		-40 to 150	$^\circ\text{C}$
Storage Temperature	T_{STG}		-65 to 155	$^\circ\text{C}$
Lead Soldering Temperature	T_L	10 seconds	260	$^\circ\text{C}$

[1] Stresses exceeding the absolute maximum ratings may damage the CT427 and may not function or be operable above the recommended operating conditions and stressing the parts to these levels is not recommended. In addition, extended exposure to stresses above the recommended operating conditions may affect device reliability. The absolute maximum ratings are stress ratings only.

[2] The lower of $V_{CC} + 0.3$ V or 6.0 V.

RECOMMENDED OPERATING CONDITIONS [1]

Characteristic	Symbol	Notes	Min.	Typ.	Max.	Unit
Supply Voltage Range	V_{CC}		3.0	3.3	3.6	V
Output Voltage Range	V_{OUT}		0	-	V_{CC}	V
Output Current	I_{OUT}		-	-	± 1.0	mA
Operating Ambient Temperature	T_A	Extended Industrial	-40	25	125	$^\circ\text{C}$
		Automotive	-40	25	125	$^\circ\text{C}$

[1] The Recommended Operating Conditions table defines the conditions for actual operation of the CT427. Recommended operating conditions are specified to ensure optimal performance to the specifications. Allegro does not recommend exceeding them or designing to absolute maximum ratings.

ISOLATION RATINGS

Characteristic	Symbol	Notes	Rating	Unit
Impulse Withstand Voltage	$V_{IMPULSE}$	Tested ± 5 pulses at 2/minute in compliance to IEC 61000-4-5 1.2 μs (rise) / 50 μs (width)	5000	V_{PK}
Dielectric Withstand Voltage	V_{ISO}	Agency rated for 60 seconds per UL 62368-1:2014 (edition 2) and per UL 1577 ^[1]	3500	V_{RMS}
Working Voltage for Basic Isolation	V_{WVBI}	Maximum approved working voltage for basic insulation according to UL 62368-1:2014 (edition 2)	792	V_{PK}
			560	V_{RMS}
Working Voltage for Reinforced Isolation	V_{WBRI}	Maximum approved working voltage for reinforced insulation according to UL 62368-1:2014 (edition 2)	396	V_{PK}
			280	V_{RMS}
Creepage Distance	D_{CR}	Minimum distance along package body from IP leads to signal leads.	4	mm
Clearance Distance	D_{CL}	Minimum distance through air from IP leads to signal leads	4	mm
Distance Through Isolation	DTI	Minimum internal distance through isolation	110	μm
Comparative Tracking Index	CTI	Material Group II	400 to 599	V

[1] 100% Production-tested for 1 second in accordance with UL 62368-1 (edition 2) and UL 1577.

APPLICATION DIAGRAM

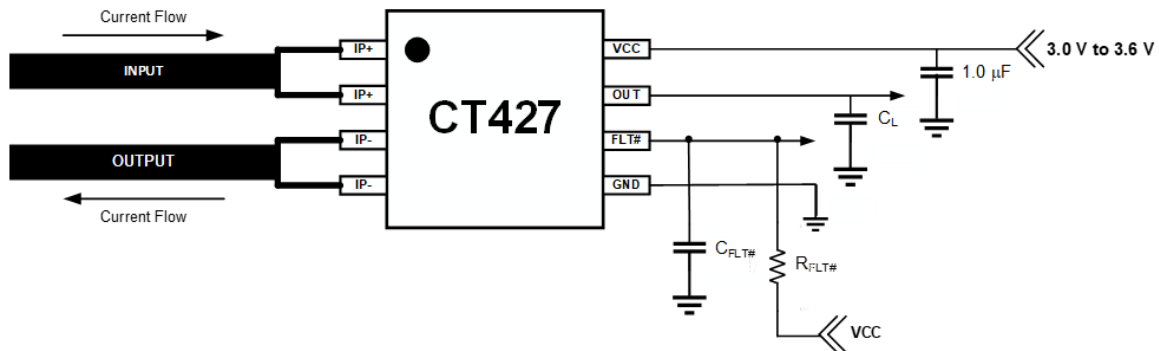

Figure 2: CT427 Application Block Diagram

Table 1: Recommended External Components

Component	Description	Vendor and Part Number	Min.	Typ.	Max.	Unit
C_{BYP}	1.0 μF , X5R or Better	Murata GRM155C81A105KA12	–	1.0	–	μF
$C_{FLT\#}$	1.0 μF , X5R or Better	Murata GRM0335C1E102JA01	–	1.0	–	nF
$R_{FLT\#}$	10 k Ω Pull-Up Resistor	Various	–	10	–	k Ω

PINOUT DIAGRAM AND TERMINAL LIST

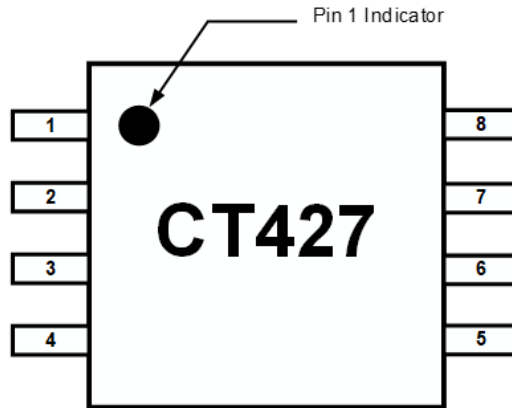

Figure 3: CT427 Pinout Diagram for 8-lead SOIC Package (Top-Down View)

Terminal List

Number	Name	Function
1, 2	IP+	Input primary conductor (positive).
3, 4	IP-	Output primary conductor (negative).
5	GND	Ground.
6	$\overline{\text{FLT}}$	Active low output fault signal (open drain output) to indicate that the following parameters are outside of normal operational bounds: <ul style="list-style-type: none"> • Overcurrent Detection • UVLO If not used, then a 1.0 nF capacitor must be connected from the pin to ground.
7	OUT	Analog output voltage that represents the measured current.
8	VCC	Supply voltage.

ELECTRICAL CHARACTERISTICS: Valid for $V_{CC} = 3.0$ to 3.6 V, $C_{BYP} = 1.0$ μ F, and $T_A = -40^\circ\text{C}$ to 125°C , typical values are $V_{CC} = 3.3$ V and $T_A = 25^\circ\text{C}$, unless otherwise specified

Characteristics	Symbol	Test Conditions	Min.	Typ.	Max.	Unit
POWER SUPPLIES						
Supply Current	I_{CC}	$f_{BW} = 1$ MHz, no load, $I_P = 0$ A	–	6.0	9.0	mA
OUT Maximum Drive Capability [1]	I_{OUT}	OUT covers 10% to 90% of V_{CC} span	–1.0	–	+1.0	mA
OUT Capacitive Load [1]	C_{L_OUT}		–	–	100	pF
OUT Resistive Load [1]	R_{L_OUT}		–	100	–	k Ω
Primary Conductor Resistance [1]	R_{IP}		–	1	–	m Ω
Power Supply Rejection Ratio [1]	PSRR		–	35	–	dB
Sensitivity Power Supply Rejection Ratio [1]	SPSRR		–	35	–	dB
Offset Power Supply Rejection Ratio [1]	OPSRR		–	40	–	dB
ANALOG OUTPUT (OUT)						
OUT Voltage Linear Range, Typical	V_{OUT}	$V_{SIG_AC} = \pm 1.00$ V, $V_{SIG_DC} = +2.00$ V	0.65	–	2.65	V
Output High Saturation Voltage	V_{OUT_SAT}	V_{OUT} , $T_A = 25^\circ\text{C}$	$V_{CC} - 0.30$	$V_{CC} - 0.25$	–	V
Common Mode Field Rejection Ratio [1]	CMFRR		–	–54	–	dB
			–	0.5	–	mA/G
FAULT OUTPUT (FLT)						
FLT Voltage Low	$V_{FLT\#_OL}$	$I_{FLT\#_OUT} \leq 20$ mA	0	–	0.5	V
High-Impedance Output Leakage Current	$I_{LEAK_FLT\#}$	$V_{FLT\#_OH} = V_{CC}$	–	5	–	μ A
FLT Pull-Up Resistor	R_{PU}		–	100	–	k Ω
TIMINGS						
Power-On Time [1]	t_{ON}	$V_{CC} \geq 2.50$ V	–	100	200	μ s
Rise Time [1]	t_{RISE}	$I_P = I_{RANGE(MAX)}$, $T_A = 25^\circ\text{C}$, $C_L = 100$ pF	–	200	–	ns
Response Time [1]	$t_{RESPONSE}$	$I_P = I_{RANGE(MAX)}$, $T_A = 25^\circ\text{C}$, $C_L = 100$ pF	–	300	–	ns
Propagation Delay [1]	t_{DELAY}	$I_P = I_{RANGE(MAX)}$, $T_A = 25^\circ\text{C}$, $C_L = 100$ pF	–	250	–	ns
FLT Response Time	$t_{FLT\#}$		–	250	–	ns
PROTECTION						
Undervoltage Lockout	V_{UVLO}	Rising V_{DD}	–	2.50	–	V
		Falling V_{DD}	–	2.45	–	V
UVLO Hysteresis	V_{UV_HYS}		–	50	–	mV
Overcurrent Detection (OCD) for DC Current (Unipolar)	I_{OCD_U}	Rising I_P	–	$1.1 \times I_{RANGE(MAX)}$	–	A
		Falling I_P	–	$0.9 \times I_{RANGE(MAX)}$	–	A
Overcurrent Detection (OCD) for AC Current (Bipolar)	I_{OCD_B}	Rising I_P	–	$1.1 \times I_{RANGE(MAX)}$	–	A
		Falling I_P	–	$0.9 \times I_{RANGE(MAX)}$	–	A
Overcurrent Detection Hysteresis	I_{OCD_HYS}		–	$0.2 \times I_{RANGE(MAX)}$	–	A

[1] Guaranteed by design and characterization; not tested in production.

ELECTRICAL CHARACTERISTICS

$V_{CC} = 3.3\text{ V}$, $T_A = 25^\circ\text{C}$, and $C_{BYP} = 1.0\ \mu\text{F}$ (unless otherwise specified)

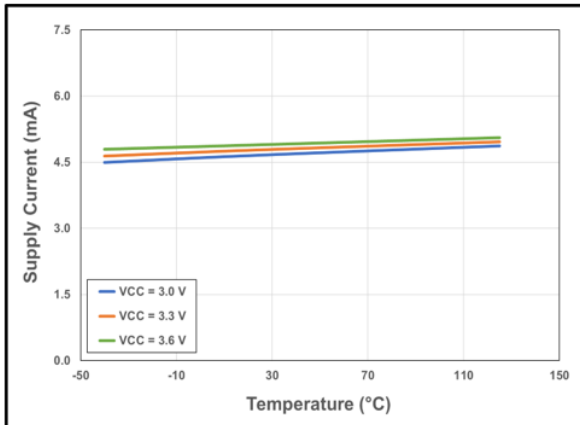

Figure 4: CT427 Supply Current vs. Temperature vs. Supply Voltage

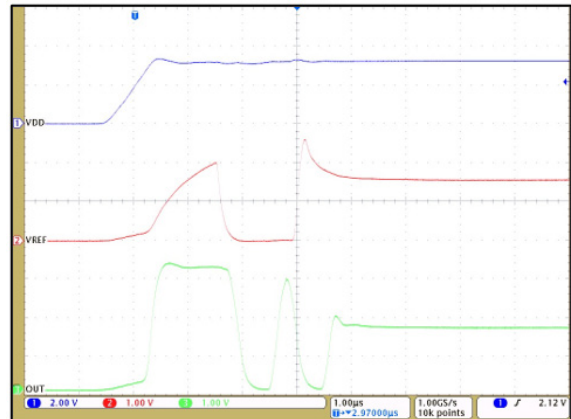

Figure 5: CT427 Startup Waveforms for $V_{OQ} = 1.65\text{ V}$ (AC Current)

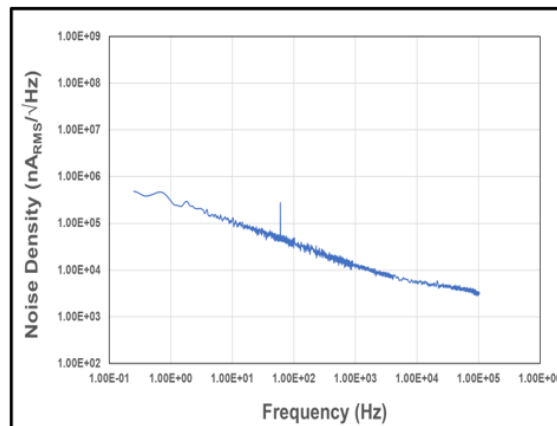

Figure 6: Noise Density vs. Frequency

ELECTRICAL CHARACTERISTICS (continued)

$V_{CC} = 3.3\text{ V}$, $T_A = 25^\circ\text{C}$, and $C_{BYP} = 1.0\ \mu\text{F}$ (unless otherwise specified)

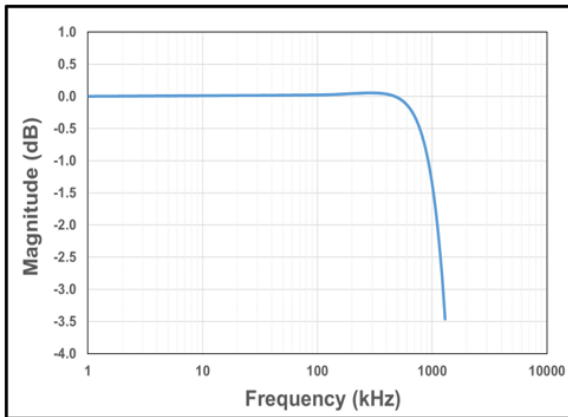

Figure 7: CT427 Bandwidth with $C_{FILTER} = 1.0\ \text{pF}$

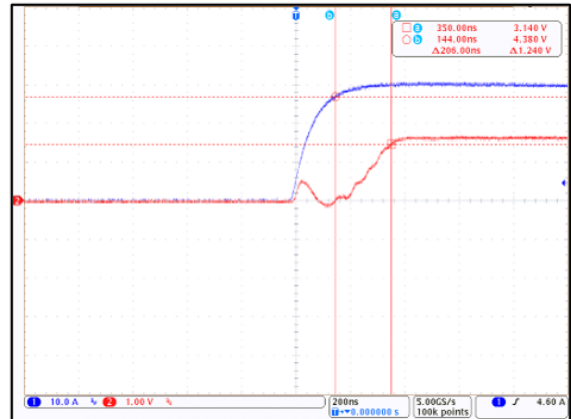

Figure 8: CT427 Response Time; $I_P = 30\ \text{A}_{PK}$ and $C_L = 100\ \text{pF}$

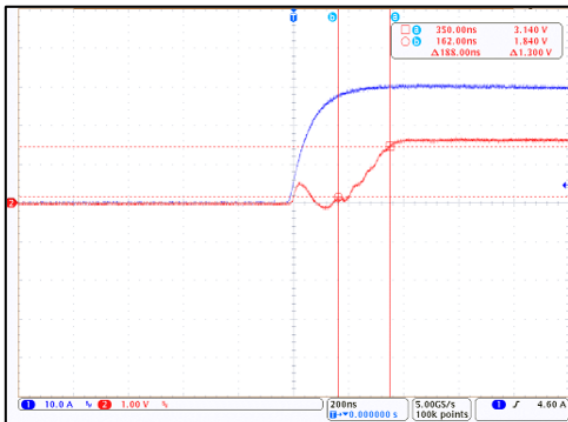

Figure 9: CT427 Rise Time; $I_P = 30\ \text{A}_{PK}$ and $C_L = 100\ \text{pF}$

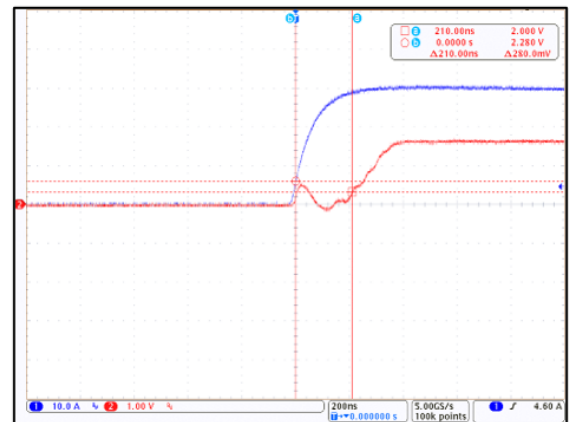

Figure 10: CT427 Propagation Delay; $I_P = 30\ \text{A}_{PK}$ and $C_L = 100\ \text{pF}$

ELECTRICAL CHARACTERISTICS (continued)

$V_{CC} = 3.3\text{ V}$, $T_A = 25^\circ\text{C}$, and $C_{BYP} = 1.0\ \mu\text{F}$ (unless otherwise specified)

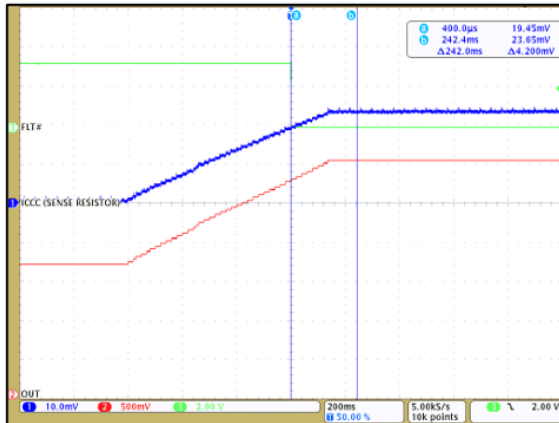

Figure 11: CT427 OCD enabled at 110% of 30 A_{PK} and FLT# is Low

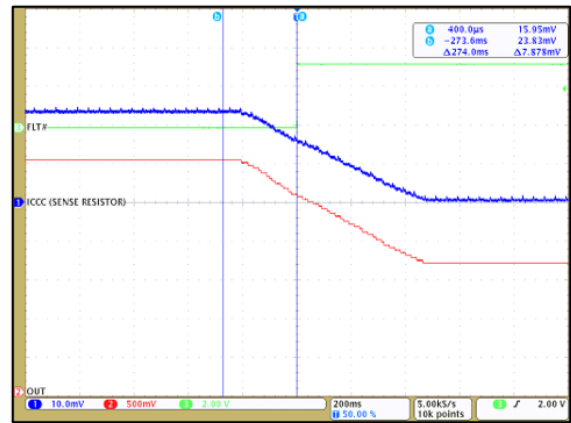

Figure 12: CT427 OCD disabled at 90% of 30 A_{PK} and FLT# is High

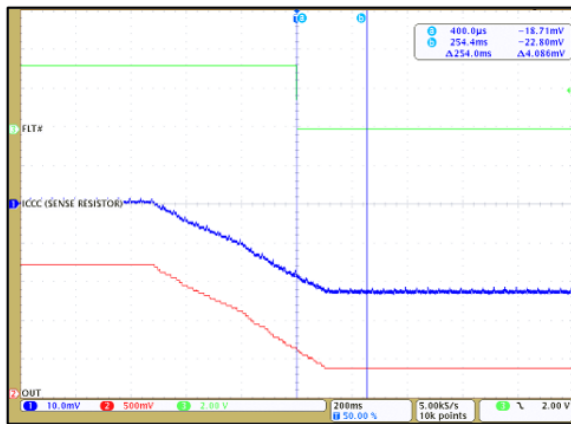

Figure 13: CT427 OCD enabled at -110% of -30 A_{PK} and FLT# is Low

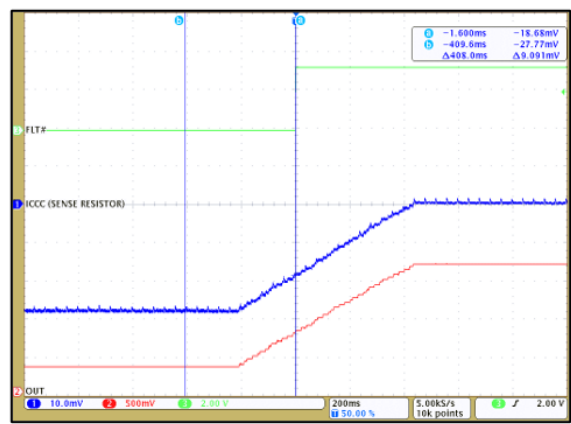

Figure 14: CT427 OCD disabled at -90% of -30 A_{PK} and FLT# is High

CT427-xSN820DR: 0 to 20 A – PERFORMANCE CHARACTERISTICS: Valid for $V_{CC} = 3.0$ to 3.6 V, $C_{BYP} = 1.0$ μ F, and $T_A = -40^\circ\text{C}$ to 125°C , unless otherwise specified

Characteristics	Symbol	Test Conditions	Min.	Typ. ^[1]	Max.	Unit
Current Range	I_{RANGE}		0	–	20	A
Voltage Output Quiescent	V_{OQ}	$T_A = 25^\circ\text{C}$, $I_P = 0$ A	0.645	0.650	0.655	V
Sensitivity	S	$I_{RANGE(MIN)} < I_P < I_{RANGE(MAX)}$	–	100	–	mV/A
Bandwidth [1]	f_{BW}	Small Signal = –3 dB	–	1.0	–	MHz
Noise [1]	e_N	$T_A = 25^\circ\text{C}$, $f_{BW} = 100$ kHz	–	9.5	–	mA_{RMS}
OUT ACCURACY PERFORMANCE						
Total Output Error	E_{TOT}	I_P sweep from $I_{P(MIN)}$ to $I_{P(MAX)}$	–	–	± 1.0	% FS
Linearity Error	E_{LIN}	$I_P = I_{P(MAX)}$, $T_A = -40^\circ\text{C}$ to 125°C	–	± 0.2	–	% FS
Sensitivity Error	E_{SENS}	$I_P = I_{P(MAX)}$, $T_A = 25^\circ\text{C}$	–	± 0.9	–	%
		$I_P = I_{P(MAX)}$, $T_A = 125^\circ\text{C}$	–	± 1.5	–	%
		$I_P = I_{P(MAX)}$, $T_A = -40^\circ\text{C}$	–	± 1.4	–	%
Offset Voltage Error	V_{OE}	$I_P = 0$ A, $T_A = 25^\circ\text{C}$	–	± 4	–	mV
		$I_P = 0$ A, $T_A = 125^\circ\text{C}$	–	± 19	–	mV
		$I_P = 0$ A, $T_A = -40^\circ\text{C}$	–	± 16	–	mV
LIFETIME DRIFT						
Total Error Including Lifetime Drift	$E_{TOT(DRIFT)}$	$I_P = I_{P(MAX)}$, $T_A = -40^\circ\text{C}$ to 125°C	–	± 2.0	–	% FS
Sensitivity Error Including Lifetime Drift	$E_{SENS(DRIFT)}$	$I_P = I_{P(MAX)}$, $T_A = -40^\circ\text{C}$ to 125°C	–	± 2.8	–	%
Offset Voltage Error Including Lifetime Drift	$V_{OE(DRIFT)}$	$I_P = 0$ A, $T_A = -40^\circ\text{C}$ to 125°C	–	± 23	–	mV

[1] Typical values are the mean ± 3 sigma of production distributions. These are formatted as mean ± 3 sigma.

[2] Lifetime drift characteristics are based on a statistical combination of production distributions and worst case distribution of parametric drift of individuals observed during AEC-Q100 qualification.

CT427-xSN820MR: ±20 A – PERFORMANCE CHARACTERISTICS: Valid for $V_{CC} = 3.0$ to 3.6 V, $C_{BYP} = 1.0$ μ F, and $T_A = -40^\circ\text{C}$ to 125°C , unless otherwise specified

Characteristics	Symbol	Test Conditions	Min.	Typ. ^[1]	Max.	Unit
Current Range	I_{RANGE}		-20	-	20	A
Voltage Output Quiescent	V_{OQ}	$T_A = 25^\circ\text{C}$, $I_P = 0$ A	1.645	1.650	1.655	V
Sensitivity	S	$I_{RANGE(MIN)} < I_P < I_{RANGE(MAX)}$	-	50	-	mV/A
Bandwidth [1]	f_{BW}	Small Signal = -3 dB	-	1.0	-	MHz
Noise [1]	e_N	$T_A = 25^\circ\text{C}$, $f_{BW} = 100$ kHz	-	11.0	-	mA_{RMS}
OUT ACCURACY PERFORMANCE						
Total Output Error	E_{TOT}	I_P sweep from $I_{P(MIN)}$ to $I_{P(MAX)}$	-	-	±1.0	% FS
Linearity Error	E_{LIN}	$I_P = I_{P(MAX)}$, $T_A = -40^\circ\text{C}$ to 125°C	-	±0.2	-	% FS
Sensitivity Error	E_{SENS}	$I_P = I_{P(MAX)}$, $T_A = 25^\circ\text{C}$	-	±0.3	-	%
		$I_P = I_{P(MAX)}$, $T_A = 125^\circ\text{C}$	-	±2.0	-	%
		$I_P = I_{P(MAX)}$, $T_A = -40^\circ\text{C}$	-	±1.7	-	%
Offset Voltage Error	V_{OE}	$I_P = 0$ A, $T_A = 25^\circ\text{C}$	-	±2	-	mV
		$I_P = 0$ A, $T_A = 125^\circ\text{C}$	-	±11	-	mV
		$I_P = 0$ A, $T_A = -40^\circ\text{C}$	-	±17	-	mV
LIFETIME DRIFT						
Total Error Including Lifetime Drift	$E_{TOT(DRIFT)}$	$I_P = I_{P(MAX)}$, $T_A = -40^\circ\text{C}$ to 125°C	-	±2.1	-	% FS
Sensitivity Error Including Lifetime Drift	$E_{SENS(DRIFT)}$	$I_P = I_{P(MAX)}$, $T_A = -40^\circ\text{C}$ to 125°C	-	±3.0	-	%
Offset Voltage Error Including Lifetime Drift	$V_{OE(DRIFT)}$	$I_P = 0$ A, $T_A = -40^\circ\text{C}$ to 125°C	-	±24	-	mV

[1] Typical values are the mean ±3 sigma of production distributions. These are formatted as mean ±3 sigma.

[2] Lifetime drift characteristics are based on a statistical combination of production distributions and worst case distribution of parametric drift of individuals observed during AEC-Q100 qualification.

CT427-xSN830DR: 0 to 30 A – PERFORMANCE CHARACTERISTICS: Valid for $V_{CC} = 3.0$ to 3.6 V, $C_{BYP} = 1.0$ μ F, and $T_A = -40^\circ\text{C}$ to 125°C , unless otherwise specified

Characteristics	Symbol	Test Conditions	Min.	Typ. ^[1]	Max.	Unit
Current Range	I_{RANGE}		0	–	30	A
Voltage Output Quiescent	V_{OQ}	$T_A = 25^\circ\text{C}$, $I_P = 0$ A	0.645	0.650	0.655	V
Sensitivity	S	$I_{RANGE(MIN)} < I_P < I_{RANGE(MAX)}$	–	66.7	–	mV/A
Bandwidth [1]	f_{BW}	Small Signal = –3 dB	–	1.0	–	MHz
Noise [1]	e_N	$T_A = 25^\circ\text{C}$, $f_{BW} = 100$ kHz	–	10.0	–	mA_{RMS}
OUT ACCURACY PERFORMANCE						
Total Output Error	E_{TOT}	I_P sweep from $I_{P(MIN)}$ to $I_{P(MAX)}$	–	–	± 1.0	% FS
Linearity Error	E_{LIN}	$I_P = I_{P(MAX)}$, $T_A = -40^\circ\text{C}$ to 125°C	–	± 0.3	–	% FS
Sensitivity Error	E_{SENS}	$I_P = I_{P(MAX)}$, $T_A = 25^\circ\text{C}$	–	± 0.2	–	%
		$I_P = I_{P(MAX)}$, $T_A = 125^\circ\text{C}$	–	± 1.2	–	%
		$I_P = I_{P(MAX)}$, $T_A = -40^\circ\text{C}$	–	± 1.2	–	%
Offset Voltage Error	V_{OE}	$I_P = 0$ A, $T_A = 25^\circ\text{C}$	–	± 5	–	mV
		$I_P = 0$ A, $T_A = 125^\circ\text{C}$	–	± 17	–	mV
		$I_P = 0$ A, $T_A = -40^\circ\text{C}$	–	± 17	–	mV
LIFETIME DRIFT						
Total Error Including Lifetime Drift	$E_{TOT(DRIFT)}$	$I_P = I_{P(MAX)}$, $T_A = -40^\circ\text{C}$ to 125°C	–	± 2.0	–	% FS
Sensitivity Error Including Lifetime Drift	$E_{SENS(DRIFT)}$	$I_P = I_{P(MAX)}$, $T_A = -40^\circ\text{C}$ to 125°C	–	± 2.7	–	%
Offset Voltage Error Including Lifetime Drift	$V_{OE(DRIFT)}$	$I_P = 0$ A, $T_A = -40^\circ\text{C}$ to 125°C	–	± 24	–	mV

[1] Typical values are the mean ± 3 sigma of production distributions. These are formatted as mean ± 3 sigma.

[2] Lifetime drift characteristics are based on a statistical combination of production distributions and worst case distribution of parametric drift of individuals observed during AEC-Q100 qualification.

CT427-xSN830MR: ±30 A – PERFORMANCE CHARACTERISTICS: Valid for $V_{CC} = 3.0$ to 3.6 V, $C_{BYP} = 1.0$ μ F, and $T_A = -40^\circ\text{C}$ to 125°C , unless otherwise specified

Characteristics	Symbol	Test Conditions	Min.	Typ. ^[1]	Max.	Unit
Current Range	I_{RANGE}		-30	-	30	A
Voltage Output Quiescent	V_{OQ}	$T_A = 25^\circ\text{C}$, $I_P = 0$ A	1.645	1.650	1.655	V
Sensitivity	S	$I_{RANGE(MIN)} < I_P < I_{RANGE(MAX)}$	-	33.3	-	mV/A
Bandwidth [1]	f_{BW}	Small Signal = -3 dB	-	1.0	-	MHz
Noise [1]	e_N	$T_A = 25^\circ\text{C}$, $f_{BW} = 100$ kHz	-	12.5	-	mA _{RMS}
OUT ACCURACY PERFORMANCE						
Total Output Error	E_{TOT}	I_P sweep from $I_{P(MIN)}$ to $I_{P(MAX)}$	-	-	±1.0	% FS
Linearity Error	E_{LIN}	$I_P = I_{P(MAX)}$, $T_A = -40^\circ\text{C}$ to 125°C	-	±0.2	-	% FS
Sensitivity Error	E_{SENS}	$I_P = I_{P(MAX)}$, $T_A = 25^\circ\text{C}$	-	±0.4	-	%
		$I_P = I_{P(MAX)}$, $T_A = 125^\circ\text{C}$	-	±2.1	-	%
		$I_P = I_{P(MAX)}$, $T_A = -40^\circ\text{C}$	-	±1.8	-	%
Offset Voltage Error	V_{OE}	$I_P = 0$ A, $T_A = 25^\circ\text{C}$	-	±2	-	mV
		$I_P = 0$ A, $T_A = 125^\circ\text{C}$	-	±14	-	mV
		$I_P = 0$ A, $T_A = -40^\circ\text{C}$	-	±16	-	mV
LIFETIME DRIFT						
Total Error Including Lifetime Drift	$E_{TOT(DRIFT)}$	$I_P = I_{P(MAX)}$, $T_A = -40^\circ\text{C}$ to 125°C	-	±2.0	-	% FS
Sensitivity Error Including Lifetime Drift	$E_{SENS(DRIFT)}$	$I_P = I_{P(MAX)}$, $T_A = -40^\circ\text{C}$ to 125°C	-	±3.1	-	%
Offset Voltage Error Including Lifetime Drift	$V_{OE(DRIFT)}$	$I_P = 0$ A, $T_A = -40^\circ\text{C}$ to 125°C	-	±23	-	mV

[1] Typical values are the mean ±3 sigma of production distributions. These are formatted as mean ±3 sigma.

[2] Lifetime drift characteristics are based on a statistical combination of production distributions and worst case distribution of parametric drift of individuals observed during AEC-Q100 qualification.

CT427-xSN850DR: 0 to 50 A – PERFORMANCE CHARACTERISTICS: Valid for $V_{CC} = 3.0$ to 3.6 V, $C_{BYP} = 1.0$ μ F, and $T_A = -40^\circ\text{C}$ to 125°C , unless otherwise specified

Characteristics	Symbol	Test Conditions	Min.	Typ. ^[1]	Max.	Unit
Current Range	I_{RANGE}		0	–	50	A
Voltage Output Quiescent	V_{OQ}	$T_A = 25^\circ\text{C}$, $I_P = 0$ A	0.645	0.650	0.655	V
Sensitivity	S	$I_{RANGE(MIN)} < I_P < I_{RANGE(MAX)}$	–	40	–	mV/A
Bandwidth [1]	f_{BW}	Small Signal = –3 dB	–	1.0	–	MHz
Noise [1]	e_N	$T_A = 25^\circ\text{C}$, $f_{BW} = 100$ kHz	–	11.0	–	mA_{RMS}
OUT ACCURACY PERFORMANCE						
Total Output Error	E_{TOT}	I_P sweep from $I_{P(MIN)}$ to $I_{P(MAX)}$	–	–	± 1.5	% FS
Linearity Error	E_{LIN}	$I_P = I_{P(MAX)}$, $T_A = -40^\circ\text{C}$ to 125°C	–	± 0.2	–	% FS
Sensitivity Error	E_{SENS}	$I_P = I_{P(MAX)}$, $T_A = 25^\circ\text{C}$	–	± 0.2	–	%
		$I_P = I_{P(MAX)}$, $T_A = 125^\circ\text{C}$	–	± 1.6	–	%
		$I_P = I_{P(MAX)}$, $T_A = -40^\circ\text{C}$	–	± 1.5	–	%
Offset Voltage Error	V_{OE}	$I_P = 0$ A, $T_A = 25^\circ\text{C}$	–	± 3	–	mV
		$I_P = 0$ A, $T_A = 125^\circ\text{C}$	–	± 9	–	mV
		$I_P = 0$ A, $T_A = -40^\circ\text{C}$	–	± 8	–	mV
LIFETIME DRIFT						
Total Error Including Lifetime Drift	$E_{TOT(DRIFT)}$	$I_P = I_{P(MAX)}$, $T_A = -40^\circ\text{C}$ to 125°C	–	± 2.3	–	% FS
Sensitivity Error Including Lifetime Drift	$E_{SENS(DRIFT)}$	$I_P = I_{P(MAX)}$, $T_A = -40^\circ\text{C}$ to 125°C	–	± 2.9	–	%
Offset Voltage Error Including Lifetime Drift	$V_{OE(DRIFT)}$	$I_P = 0$ A, $T_A = -40^\circ\text{C}$ to 125°C	–	± 17	–	mV

[1] Typical values are the mean ± 3 sigma of production distributions. These are formatted as mean ± 3 sigma.

[2] Lifetime drift characteristics are based on a statistical combination of production distributions and worst case distribution of parametric drift of individuals observed during AEC-Q100 qualification.

CT427-xSN850MR: ±50 A – PERFORMANCE CHARACTERISTICS: Valid for $V_{CC} = 3.0$ to 3.6 V, $C_{BYP} = 1.0$ μ F, and $T_A = -40^\circ\text{C}$ to 125°C , unless otherwise specified

Characteristics	Symbol	Test Conditions	Min.	Typ. ^[1]	Max.	Unit
Current Range	I_{RANGE}		-50	-	50	A
Voltage Output Quiescent	V_{OQ}	$T_A = 25^\circ\text{C}$, $I_P = 0$ A	1.645	1.650	1.655	V
Sensitivity	S	$I_{RANGE(MIN)} < I_P < I_{RANGE(MAX)}$	-	20	-	mV/A
Bandwidth [1]	f_{BW}	Small Signal = -3 dB	-	1.0	-	MHz
Noise [1]	e_N	$T_A = 25^\circ\text{C}$, $f_{BW} = 100$ kHz	-	19.0	-	mA_{RMS}
OUT ACCURACY PERFORMANCE						
Total Output Error	E_{TOT}	I_P sweep from $I_{P(MIN)}$ to $I_{P(MAX)}$	-	-	± 1.0	% FS
Linearity Error	E_{LIN}	$I_P = I_{P(MAX)}$, $T_A = -40^\circ\text{C}$ to 125°C	-	± 0.2	-	% FS
Sensitivity Error	E_{SENS}	$I_P = I_{P(MAX)}$, $T_A = 25^\circ\text{C}$	-	± 0.2	-	%
		$I_P = I_{P(MAX)}$, $T_A = 125^\circ\text{C}$	-	± 2.0	-	%
		$I_P = I_{P(MAX)}$, $T_A = -40^\circ\text{C}$	-	± 1.1	-	%
Offset Voltage Error	V_{OE}	$I_P = 0$ A, $T_A = 25^\circ\text{C}$	-	± 1	-	mV
		$I_P = 0$ A, $T_A = 125^\circ\text{C}$	-	± 11	-	mV
		$I_P = 0$ A, $T_A = -40^\circ\text{C}$	-	± 10	-	mV
LIFETIME DRIFT						
Total Error Including Lifetime Drift	$E_{TOT(DRIFT)}$	$I_P = I_{P(MAX)}$, $T_A = -40^\circ\text{C}$ to 125°C	-	± 2.1	-	% FS
Sensitivity Error Including Lifetime Drift	$E_{SENS(DRIFT)}$	$I_P = I_{P(MAX)}$, $T_A = -40^\circ\text{C}$ to 125°C	-	± 3.1	-	%
Offset Voltage Error Including Lifetime Drift	$V_{OE(DRIFT)}$	$I_P = 0$ A, $T_A = -40^\circ\text{C}$ to 125°C	-	± 19	-	mV

[1] Typical values are the mean ± 3 sigma of production distributions. These are formatted as mean ± 3 sigma.

[2] Lifetime drift characteristics are based on a statistical combination of production distributions and worst case distribution of parametric drift of individuals observed during AEC-Q100 qualification.

CT427-xSN865DR: 0 to 65 A – PERFORMANCE CHARACTERISTICS: Valid for $V_{CC} = 3.0$ to 3.6 V, $C_{BYP} = 1.0$ μ F, and $T_A = -40^\circ\text{C}$ to 125°C , unless otherwise specified

Characteristics	Symbol	Test Conditions	Min.	Typ. ^[1]	Max.	Unit
Current Range	I_{RANGE}		0	–	65	A
Voltage Output Quiescent	V_{OQ}	$T_A = 25^\circ\text{C}$, $I_P = 0$ A	0.645	0.650	0.655	V
Sensitivity	S	$I_{RANGE(MIN)} < I_P < I_{RANGE(MAX)}$	–	30.8	–	mV/A
Bandwidth [1]	f_{BW}	Small Signal = –3 dB	–	1.0	–	MHz
Noise [1]	e_N	$T_A = 25^\circ\text{C}$, $f_{BW} = 100$ kHz	–	11.5	–	mA_{RMS}
OUT ACCURACY PERFORMANCE						
Total Output Error	E_{TOT}	I_P sweep from $I_{P(MIN)}$ to $I_{P(MAX)}$	–	–	± 1.5	% FS
Linearity Error	E_{LIN}	$I_P = I_{P(MAX)}$, $T_A = -40^\circ\text{C}$ to 125°C	–	± 0.2	–	% FS
Sensitivity Error	E_{SENS}	$I_P = I_{P(MAX)}$, $T_A = 25^\circ\text{C}$	–	± 0.4	–	%
		$I_P = I_{P(MAX)}$, $T_A = 125^\circ\text{C}$	–	± 1.9	–	%
		$I_P = I_{P(MAX)}$, $T_A = -40^\circ\text{C}$	–	± 1.9	–	%
Offset Voltage Error	V_{OE}	$I_P = 0$ A, $T_A = 25^\circ\text{C}$	–	± 3	–	mV
		$I_P = 0$ A, $T_A = 125^\circ\text{C}$	–	± 12	–	mV
		$I_P = 0$ A, $T_A = -40^\circ\text{C}$	–	± 10	–	mV
LIFETIME DRIFT						
Total Error Including Lifetime Drift	$E_{TOT(DRIFT)}$	$I_P = I_{P(MAX)}$, $T_A = -40^\circ\text{C}$ to 125°C	–	± 2.6	–	% FS
Sensitivity Error Including Lifetime Drift	$E_{SENS(DRIFT)}$	$I_P = I_{P(MAX)}$, $T_A = -40^\circ\text{C}$ to 125°C	–	± 3.2	–	%
Offset Voltage Error Including Lifetime Drift	$V_{OE(DRIFT)}$	$I_P = 0$ A, $T_A = -40^\circ\text{C}$ to 125°C	–	± 18	–	mV

[1] Typical values are the mean ± 3 sigma of production distributions. These are formatted as mean ± 3 sigma.

[2] Lifetime drift characteristics are based on a statistical combination of production distributions and worst case distribution of parametric drift of individuals observed during AEC-Q100 qualification.

CT427-xSN865MR: ±65 A – PERFORMANCE CHARACTERISTICS: Valid for $V_{CC} = 3.0$ to 3.6 V, $C_{BYP} = 1.0$ μ F, and $T_A = -40^\circ\text{C}$ to 125°C , unless otherwise specified

Characteristics	Symbol	Test Conditions	Min.	Typ. ^[1]	Max.	Unit
Current Range	I_{RANGE}		-65	-	65	A
Voltage Output Quiescent	V_{OQ}	$T_A = 25^\circ\text{C}$, $I_P = 0$ A	1.645	1.650	1.655	V
Sensitivity	S	$I_{RANGE(MIN)} < I_P < I_{RANGE(MAX)}$	-	15.4	-	mV/A
Bandwidth [1]	f_{BW}	Small Signal = -3 dB	-	1.0	-	MHz
Noise [1]	e_N	$T_A = 25^\circ\text{C}$, $f_{BW} = 100$ kHz	-	19.0	-	mA_{RMS}
OUT ACCURACY PERFORMANCE						
Total Output Error	E_{TOT}	I_P sweep from $I_{P(MIN)}$ to $I_{P(MAX)}$	-	-	± 1.0	% FS
Linearity Error	E_{LIN}	$I_P = I_{P(MAX)}$, $T_A = -40^\circ\text{C}$ to 125°C	-	± 0.2	-	% FS
Sensitivity Error	E_{SENS}	$I_P = I_{P(MAX)}$, $T_A = 25^\circ\text{C}$	-	± 0.3	-	%
		$I_P = I_{P(MAX)}$, $T_A = 125^\circ\text{C}$	-	± 1.9	-	%
		$I_P = I_{P(MAX)}$, $T_A = -40^\circ\text{C}$	-	± 1.6	-	%
Offset Voltage Error	V_{OE}	$I_P = 0$ A, $T_A = 25^\circ\text{C}$	-	± 2	-	mV
		$I_P = 0$ A, $T_A = 125^\circ\text{C}$	-	± 14	-	mV
		$I_P = 0$ A, $T_A = -40^\circ\text{C}$	-	± 17	-	mV
LIFETIME DRIFT						
Total Error Including Lifetime Drift	$E_{TOT(DRIFT)}$	$I_P = I_{P(MAX)}$, $T_A = -40^\circ\text{C}$ to 125°C	-	± 2.0	-	% FS
Sensitivity Error Including Lifetime Drift	$E_{SENS(DRIFT)}$	$I_P = I_{P(MAX)}$, $T_A = -40^\circ\text{C}$ to 125°C	-	± 3.0	-	%
Offset Voltage Error Including Lifetime Drift	$V_{OE(DRIFT)}$	$I_P = 0$ A, $T_A = -40^\circ\text{C}$ to 125°C	-	± 24	-	mV

[1] Typical values are the mean ± 3 sigma of production distributions. These are formatted as mean ± 3 sigma.

[2] Lifetime drift characteristics are based on a statistical combination of production distributions and worst case distribution of parametric drift of individuals observed during AEC-Q100 qualification.

FUNCTIONAL DESCRIPTION

Overview

The CT427 is a high accuracy contact current sensor with an integrated current-carrying conductor that handles up to 65 A. It has high sensitivity and a wide dynamic range with excellent accuracy (low total output error) across temperature. This current sensor supports eight current ranges:

- 0 to 20 A
- ±20 A
- 0 to 30 A
- ±30 A
- 0 to 50 A
- ±50 A
- 0 to 65 A
- ±65 A

When current is flowing through the current-carrying conductor, the XtremeSense TMR sensors inside the chip senses the field which in turn generates differential voltage signals that then goes through the Analog Front-End (AFE) to output a current measurement with less than ±1.0% full-scale total output error (E_{OUT}).

The chip is designed to enable a fast response time of 300 ns for the current measurement from the OUT pin as the bandwidth for the CT427 is 1.0 MHz. Even with a high bandwidth, the chip consumes a minimal amount of power.

Linear Output Current Measurement

The CT427 provides a continuous linear analog output voltage which represents the current measurement. The output voltage range of OUT is from 0.65 to 2.65 V with a V_{OQ} of 0.65 V and 1.65 V for unidirectional and bidirectional currents, respectively. Figure 15 illustrates the output voltage range of the OUT pin as a function of the measured current.

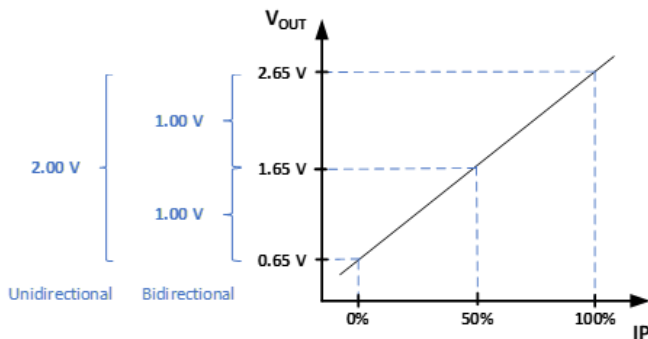

Figure 15: Linear Output Voltage Range (OUT) vs. Measured Current (IP)

Sensitivity

Sensitivity (S) is a change in the CT427 output in response to a change in 1 A of current flowing through the current-carrying conductor. It is defined by the product of the magnetic circuit sensitivity (G/A, where 1.0 G = 0.1 mT) and the chip linear amplifier gain (mV/G). Therefore, the result of this gives a sensitivity unit of mV/A. The CT427 is factory-calibrated to optimize the sensitivity for the full scale of the device dynamic range.

Total Output Error

The Total Output Error (E_{OUT}) is the maximum deviation of the sensor output from the ideal sensor transfer curve over the full temperature range relative to the sensor full scale.

The Total Output Error is measured by performing a full-scale primary current (IP) sweep and measuring V_{OUT} at multiple points.

$$E_{OUT} = 100 * \frac{\max(V_{OUT_{IDEAL}}(I) - V_{OUT}(I))}{F.S.}$$

The Ideal Transfer Curve is calculated based on datasheet parameters as described below.

$$V_{OUT_{IDEAL}}(I_P) = V_{OQ} + S * I_P$$

E_{OUT} incorporates all sources of error and is a function of the sensed current (I_P) from the current sensor.

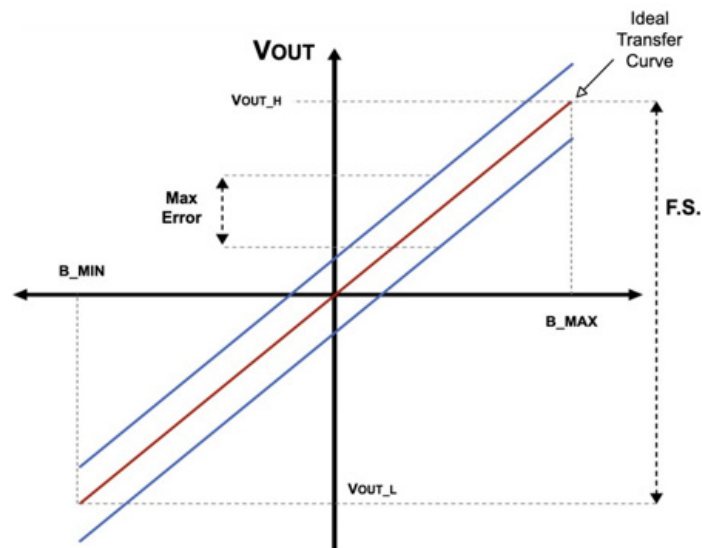

Figure 16: Total Output Error (E_{OUT}) vs. Sensed Current (I_P)

The CT427 achieves a total output error (E_{OUT}) that is less than $\pm 1.0\%$ of Full-Scale (FS) over supply voltage and temperature. It is designed with innovative and proprietary TMR sensors and circuit blocks to provide very accurate current measurements regardless of the operating conditions.

Sensitivity Error

The sensitivity error (E_{SENS}) is the sensitivity temperature drift error for unipolar or DC current. It is calculated using the equation below:

$$E_{SENS} = 100 \times \left(\frac{S_{MEASURED}}{S} - 1 \right)$$

For bipolar or AC current, the E_{SENS} is calculated by dividing the equation by 2.

Power-On Time (t_{ON})

Power-On Time (t_{ON}) of 100 μs is the amount of time required by CT427 to start up, fully power the chip, and becoming fully operational from the moment the supply voltage is applied to it. This time includes the ramp-up time and the settling time (within 10% of steady-state voltage under an applied magnetic field) after the power supply has reached the minimum V_{CC} .

Response Time ($t_{RESPONSE}$)

Response Time ($t_{RESPONSE}$) of 300 ns for the CT427 is the time interval between the following terms:

1. When the primary current signal reaches 90% of its final value,
2. When the chip reaches 90% of its output corresponding to the applied current.

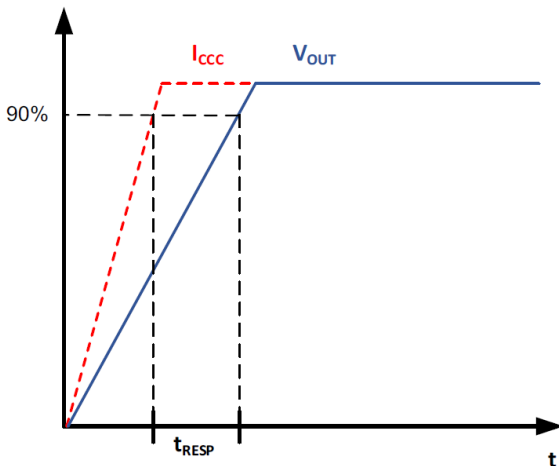

Figure 17: CT427 Response Time Curve

Rise Time (t_{RISE})

Rise Time (t_{RISE}) is the time interval of when it reaches 10% and 90% of the full-scale output voltage. The t_{RISE} of the CT427 is 200 ns.

Propagation Delay (t_{DELAY})

Propagation Delay (t_{DELAY}) is the time difference between these two events:

1. When the primary current reaches 20% of its final value
2. When the chip reaches 20% of its output corresponding to the applied current.

The CT427 has a propagation delay of 250 ns.

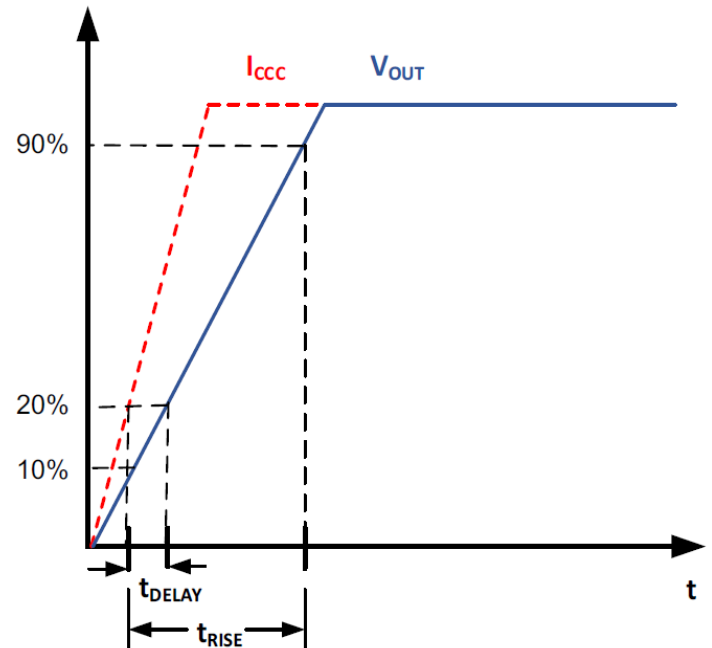

Figure 18: CT427 Propagation Delay and Rise Time Curve

Undervoltage Lockout (UVLO)

The Undervoltage Lockout protection circuitry of the CT427 is activated when the supply voltage (V_{CC}) falls below 2.45 V. The CT427 remains in a low quiescent state until V_{CC} rises above the UVLO threshold (2.50 V). In this condition where V_{CC} is less than 2.45 V and UVLO is triggered, the output from the CT427 is not valid, and the \overline{FLT} pin will go low. Once V_{CC} rises above 2.50 V then the UVLO is cleared, and the \overline{FLT} pin will be high

Immunity to Common Mode Fields

The CT427 is housed in a custom plastic package that uses a U-shaped leadframe to reduce the common mode fields generated as current flows through the current-carrying conductor. With the U-shaped leadframe, the stray fields cancel one another thus reducing electromagnetic interference (EMI).

Also, a good PCB layout of the CT427 will optimize performance and reduce EMI. See the Applications Information section in this datasheet for recommendations on PCB layout.

Creepage and Clearance

Two important terms as it relates to isolation provided by the package are: creepage and clearance. Creepage is defined as the shortest distance across the surface of the package from one side the leads to the other side of the leads. The definition for clearance is the shortest distance between the leads of opposite side through the air.

Application

The CT427 is an integrated contact current sensor that can be used in many applications from measuring current in power supplies to motor control to overcurrent fault protection. It is a plug-and-play solution in that no calibration is required, and it outputs to a microcontroller a simple linear analog output voltage which corresponds to a current measurement value.

It is designed to support an operating voltage range of 3.0 to 3.6 V, but it is ideal to use a 3.3 V power supply where the output tolerance is less than $\pm 5\%$.

Bypass Capacitor

A single 1.0 μF capacitor is needed for the VCC pin to reduce the noise from the power supply and other circuits. This capacitor should be placed as close as possible to the CT427 to minimize inductance and resistance between the two devices.

$\overline{\text{FLT}}$ Resistor and Capacitor

For the CT427, the $\overline{\text{FLT}}$ pin is an open drain output. It requires a pull-up resistor value of 100 k Ω to be connected from the pin to V_{CC} and also a 1.0 nF capacitor to be connected from the pin to ground.

If the $\overline{\text{FLT}}$ pin function is not needed in the application, then a 1.0 nF capacitor must be connected from the pin to ground.

Fault# Interrupt ($\overline{\text{FLT}}$)

The CT427 generates an active low digital fault signal via the $\overline{\text{FLT}}$ pin to interrupt the microcontroller to indicate a fault event has been triggered. It is an open drain output and requires a pull-up resistor with a value of 100 k Ω tied to VCC and a 1.0 nF capacitor is connected to ground. A fault signal will interrupt the host system for these events:

- OCD
- UVLO

The $\overline{\text{FLT}}$ signal will be asserted low whenever one of the above fault events occur. In the case of an UVLO event, the $\overline{\text{FLT}}$ pin will stay low until the fault is cleared and then go high.

If the $\overline{\text{FLT}}$ is not used, then a 1.0 nF capacitor must be connected from the pin to ground.

Recommended PCB Layout

Since the CT427 can measure up to 65 A of current, special care must be taken in the printed circuit board (PCB) layout of the CT427 and the surrounding circuitry. It is recommended that the CCC pins be connected to as much copper area as possible. It is also recommended that 2 oz. or heavier copper be used for PCB traces when the CT427 is used to measure up to 30 A of current. Additional layers of the PCB should also be used to carry current and be connected using the arrangement of vias. Figure 19 and Figure 20 show the recommended the PCB layout for the 20 A and 30 A variants of CT427. For the 65 A variant, it is recommended that 4 oz. of copper be used for the PCB traces.

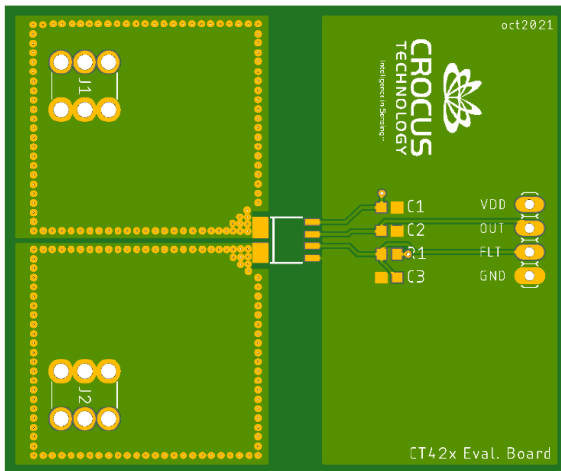

Figure 19: Recommended PCB Layout (Top Layer) for the 20 A to 65 A variants of the CT427

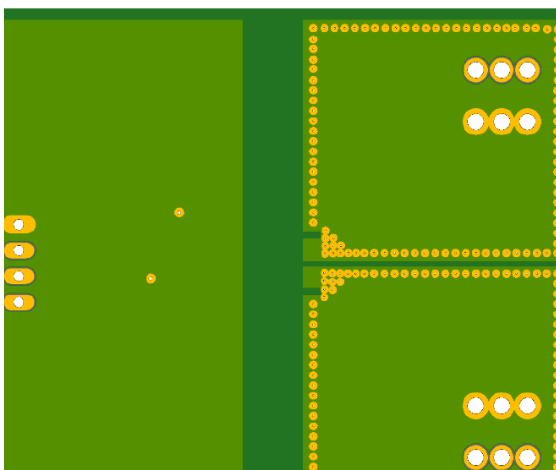

Figure 20: Recommended PCB Layout (Bottom Layer) for the 20 A to 65 A variants of the CT427

Thermal Rise vs. Primary Current

Self-heating due to the flow of current should be considered during the design of any current sensing system. The sensor, printed circuit board (PCB), and contacts to the PCB will generate heat as current moves through the system.

The thermal response is highly dependent on PCB layout, copper thickness, cooling techniques, and the profile of the injected current.

The current profile includes peak current, current on-time, and duty cycle. While the data presented in this section was collected with direct current (DC), these numbers may be used to approximate thermal response for both AC signals and current pulses.

The plot in Figure 21 shows the measured rise in steady-state die temperature of the current sensor versus continuous current at an ambient temperature, T_A , of 25 °C. The thermal offset curves may be directly applied to other values of T_A .

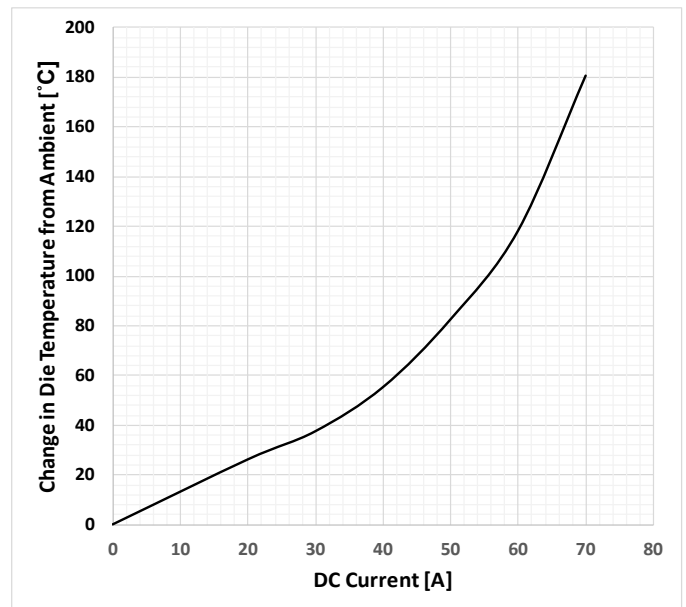

Figure 21: Self Heating in the LA Package Due to Current Flow

PACKAGE OUTLINE DRAWING

For Reference Only – Not for Tooling Use

Dimensions in millimeters – NOT TO SCALE

Dimensions exclusive of mold flash, gate burs, and dambar protrusions

Exact case and lead configuration at supplier discretion within limits shown

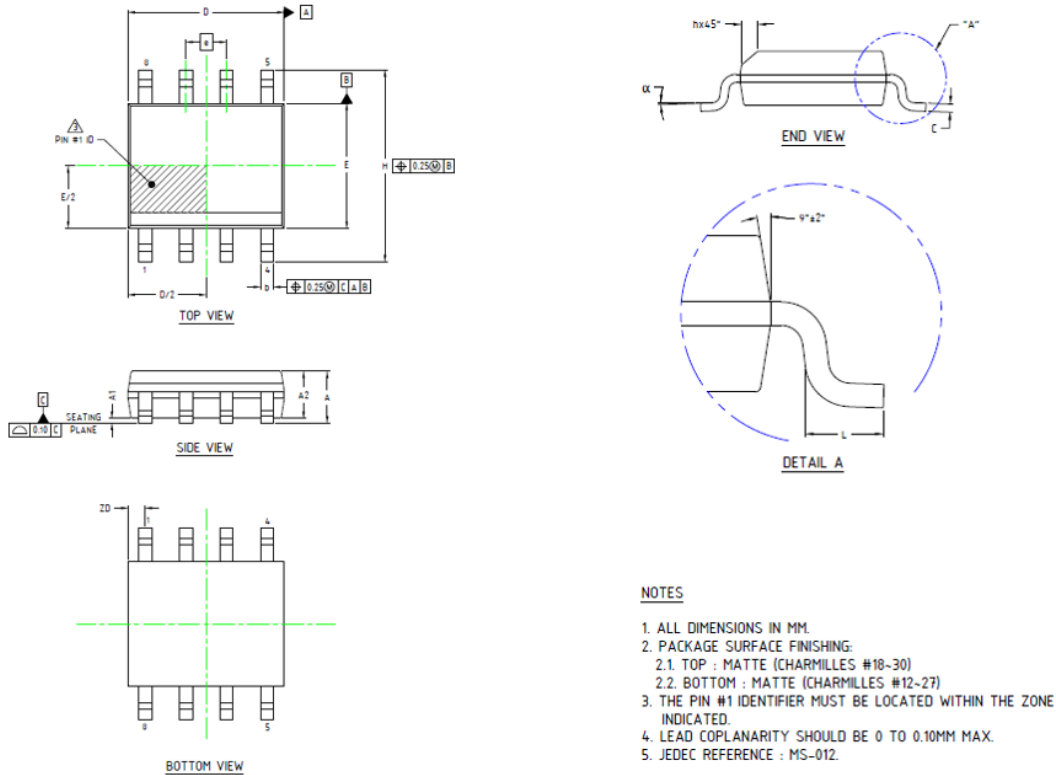

Figure 22: SOIC-8 Package Drawing and Dimensions

Table 2: CT427 SOIC-8 Package Dimensions

Symbol	Dimensions in Millimeters (mm)		
	Min.	Typ.	Max.
A1	0.10	0.18	0.25
b	0.36	0.41	0.46
C	0.19	0.22	0.25
D	4.80	4.89	4.98
E	3.81	3.90	3.99
e	1.27 BSC		
H	5.80	6.00	6.20
h	0.25	0.37	0.50
L	0.41	–	1.27
A	1.52	1.62	1.72
α	0°	–	8°
ZD	0.53 REF		
A2	1.37	1.47	1.57

TAPE AND REEL POCKET DRAWING AND DIMENSIONS

For Reference Only – Not for Tooling Use

Dimensions in millimeters – NOT TO SCALE

Dimensions exclusive of mold flash, gate burs, and dambar protrusions

Exact case and lead configuration at supplier discretion within limits shown

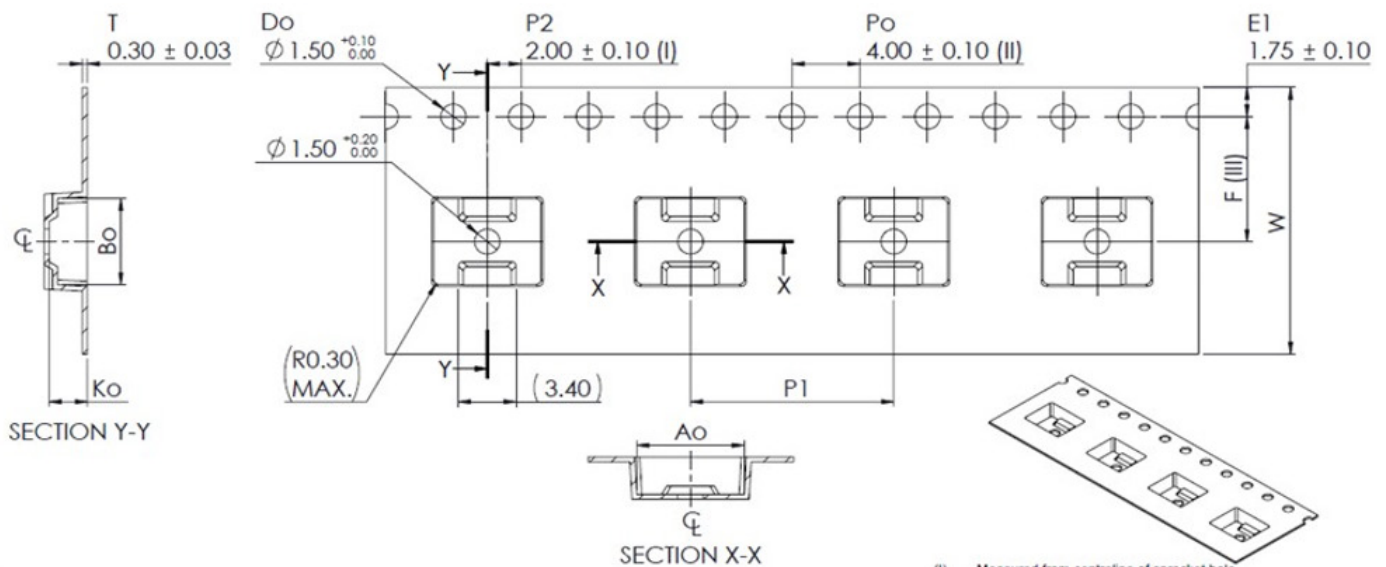

Ao	6.35	+/- 0.10
Bo	5.13	+/- 0.10
Ko	2.25	+/- 0.15
K1	1.75	+/- 0.10
F	7.50	+/- 0.10
P1	12.00	+/- 0.10
W	16.00	+0.30 / -0.10

- (I) Measured from centreline of sprocket hole to centreline of pocket.
- (II) Cumulative tolerance of 10 sprocket holes is ± 0.20 .
- (III) Measured from centreline of sprocket hole to centreline of pocket.
- (IV) Other material available.
- (V) Dimension with () is used for design reference purposes, No measurement required.

ALL DIMENSIONS IN MILLIMETRES UNLESS OTHERWISE STATED.

Figure 23: Tape and Pocket Drawing for SOIC-8 Package

PACKAGE INFORMATION

Table 3: CT427 Package Information

Part Number	Package Type	# of Leads	Package Quantity	Lead Finish	MSL Rating [2]	Operating Temperature (°C) [3]	Device Marking [4]
CT427-HSN820DR	SOIC	8	2000	Sn	3	-40 to 125	CT427 S820DR YYWWLL
CT427-ASN820DR	SOIC	8	2000	Sn	3	-40 to 125	CT427A S820DR YYWWLL
CT427-HSN820MR	SOIC	8	2000	Sn	3	-40 to 125	CT427 S820MR YYWWLL
CT427-ASN820MR	SOIC	8	2000	Sn	3	-40 to 125	CT427A S820MR YYWWLL
CT427-HSN830DR	SOIC	8	2000	Sn	3	-40 to 125	CT427 S830DR YYWWLL
CT427-ASN830DR	SOIC	8	2000	Sn	3	-40 to 125	CT427A S830DR YYWWLL
CT427-HSN830MR	SOIC	8	2000	Sn	3	-40 to 125	CT427 S830MR YYWWLL
CT427-ASN830MR	SOIC	8	2000	Sn	3	-40 to 125	CT427A S830MR YYWWLL
CT427-HSN850DR	SOIC	8	2000	Sn	3	-40 to 125	CT427 S850DR YYWWLL
CT427-ASN850DR	SOIC	8	2000	Sn	3	-40 to 125	CT427A S850DR YYWWLL
CT427-HSN850MR	SOIC	8	2000	Sn	3	-40 to 125	CT427 S850MR YYWWLL
CT427-ASN850MR	SOIC	8	2000	Sn	3	-40 to 125	CT427A S850MR YYWWLL
CT427-HSN865DR	SOIC	8	2000	Sn	3	-40 to 125	CT427 S865DR YYWWLL
CT427-ASN865DR	SOIC	8	2000	Sn	3	-40 to 125	CT427A S865DR YYWWLL
CT427-HSN865MR	SOIC	8	2000	Sn	3	-40 to 125	CT427 S865MR YYWWLL
CT427-ASN865MR	SOIC	8	2000	Sn	3	-40 to 125	CT427A S865MR YYWWLL

[1] RoHS is defined as semiconductor products that are compliant to the current EU RoHS requirements. It also will meet the requirement that RoHS substances do not exceed 0.1% by weight in homogeneous materials. Green is defined as the content of chlorine (Cl), bromine (Br), and antimony trioxide based flame retardants satisfy JS709B low halogen requirements of $\leq 1,000$ ppm.

[2] MSL Rating = Moisture Sensitivity Level Rating as defined by JEDEC standard classifications.

[3] Package will withstand ambient temperature range of -40°C to 125°C and storage temperature range of -65°C to 150°C .

[4] Device Marking for CT427 is defined as CT427 S8xxZR YYWWLL where the first 2 lines = part number, YY = year, WW = work week, and LL = lot code.

DEVICE MARKING

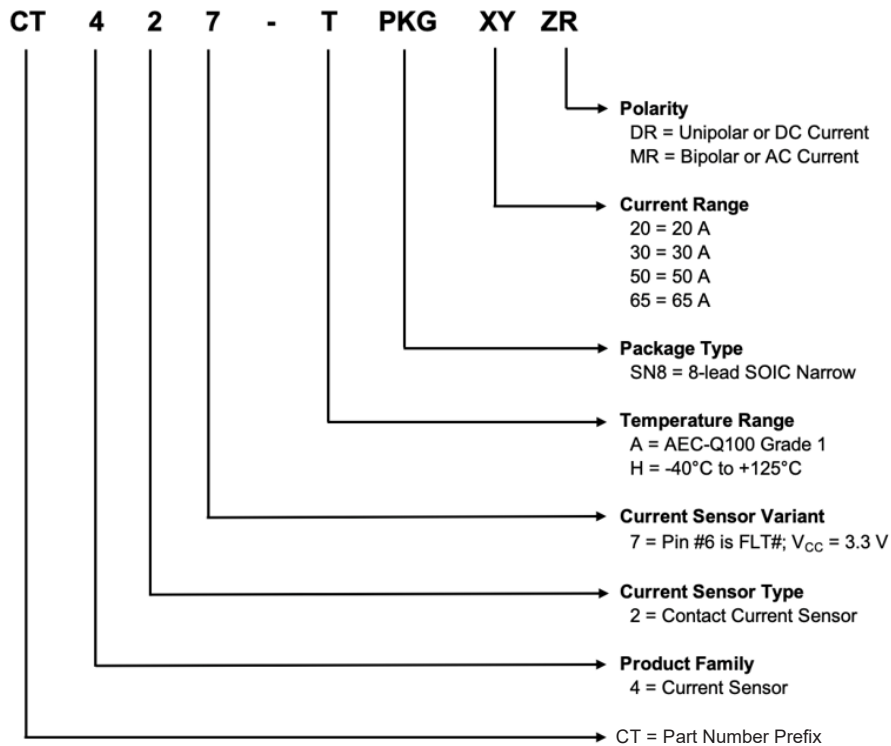

Figure 24: CT427 Device Marking for 8-lead Package

Table 4: CT427 Device Marking Definition for 8-lead SOIC Package

Row No.	Code	Definition
3	•	Pin 1 Indicator
1	CT427	Allegro Part Number
1	A	AEC-Q100 Qualified
2	P	Package Type
2	N	Number of Pins
2	XX	Current Range
2	ZR	Polarity
3	YY	Calendar Year
3	WW	Work Week
3	LL	Lot Code

PART ORDERING NUMBER LEGEND



Revision History

Number	Date	Description
2	November 2, 2023	Document rebranded and minor editorial updates
3	May 2, 2024	Updated Title, Description, and Features and Benefits (page 1); updated Table of Contents (page 2); removed Thermal Characteristics table (page 3); removed IEC 61000 reference (pages 1 and 3); updated Isolation Ratings table (page 4); updated Primary Conductor Resistance (page 6); updated Total Output Error values (pages 14 and 16); added Thermal Rise vs. Primary Current section (page 21); removed performance graph pages.
4	June 4, 2024	Added notes to package drawings (pages 22 and 23)

Copyright 2024, Allegro MicroSystems.

Allegro MicroSystems reserves the right to make, from time to time, such departures from the detail specifications as may be required to permit improvements in the performance, reliability, or manufacturability of its products. Before placing an order, the user is cautioned to verify that the information being relied upon is current.

Allegro's products are not to be used in any devices or systems, including but not limited to life support devices or systems, in which a failure of Allegro's product can reasonably be expected to cause bodily harm.

The information included herein is believed to be accurate and reliable. However, Allegro MicroSystems assumes no responsibility for its use; nor for any infringement of patents or other rights of third parties which may result from its use.



Copies of this document are considered uncontrolled documents.

For the latest version of this document, visit our website:

www.allegromicro.com

Looking for pricing, stock, or lifecycle information?

Click below to explore more details on WIN SOURCE:

-  [View CT427-HSN865MR on WIN SOURCE](#)
-  [Allegro MicroSystems, LLC Information](#)

Optimize Your Supply Chain with WIN SOURCE Solutions

-  Global Sourcing Solution
-  Obsolete Management
-  Cost Control Management
-  Shortage Management
-  Alternative Solution
-  Excess Inventory Management