



**THE DATASHEET OF
XSL500-30-A**



USLS SERIES

RoHS
Compliant

0.4mm PITCH CONNECTOR FOR MICRO COAXIAL CABLE (STACKING TYPE)

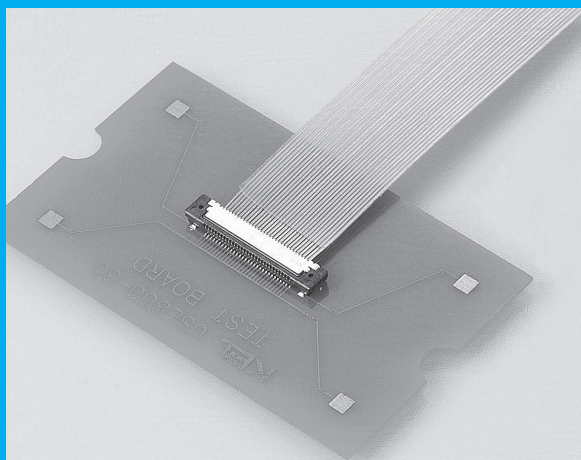

FEATURES

- ▶ Compact connector with a low profile of 1.65 mm(0.065") and a mating width of 3.05 mm(0.120").
- ▶ For micro coaxial cable (#42 AWG).
- ▶ IDC of contacts all together is adopted for improved connection reliability and more compact connectors.
- ▶ Equipped with a metal shell, noise reduction and product strength are ensured.
- ▶ Multiple ground terminals are provided for enhanced transmission characteristics and EMS protection.
- ▶ Highly reliable design with effective mating length of 0.35mm(0.014").
- ▶ Nickel barrier of the board side contact prevents solder wicking.
- ▶ Possible to put through narrow tube with a diameter of $\phi 2.7\text{mm}(\phi 0.106\text{'})$ even after soldering.

*Specially designed withdrawal jig is available.

ORDER CODE

USLS00- - -

① ② ③

*Please order in multiples of the quantity per package.

- ① **[Type]** USLS00 : Receptacle (PCB side connector)
- ② **[Number of contacts]** 20 : 20 pin 30 : 30 pin 40 : 40 pin
- ③ **[Number of packaging]** A : 500pcs. per reel B : 1,000pcs. per reel C : 3,000pcs. per reel

ORDER CODE

USLS20- -

① ②

*Please order in multiples of the quantity per package.

- ① **[Type]** USLS20 : Plug (Cable side connector)
- ② **[Number of contacts]** 20 : 20 pin 30 : 30 pin 40 : 40 pin

*Plug (cable side connector) is composed of base and cover.

SPECIFICATIONS

Material and plating		Electrical characteristics	
Insulator material	Glass-filled LCP(UL94V-0),Black	Rated current	0.25A per contact
Contact material	Copper alloy	Contact resistance	100mΩ max.
Contact plating	Gold over Nickel Nickel Barrier(Board side)	Dielectric withstanding voltage	200V AC for 1minute
Shell material	Copper alloy	Insulation resistance	100MΩ min.at 250V DC
Shell plating	Gold over Nickel(Shell 1) Tin copper over Nickel(Shell 2)	Operating temperature	-40°C to +85°C
Cover material	Glass-filled LCP(UL94V-0),Black	Applicable cable	#42 AWG Micro coaxial cable
Adsorption tape material	[USLS00] Polyimide		

Mating drawing

Unit : mm(inch)

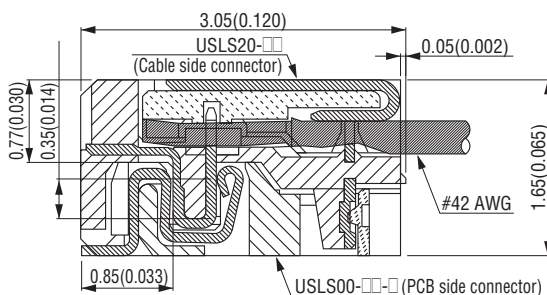

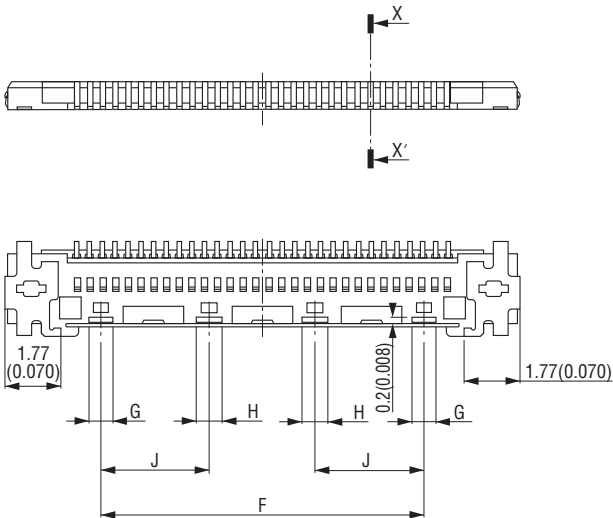
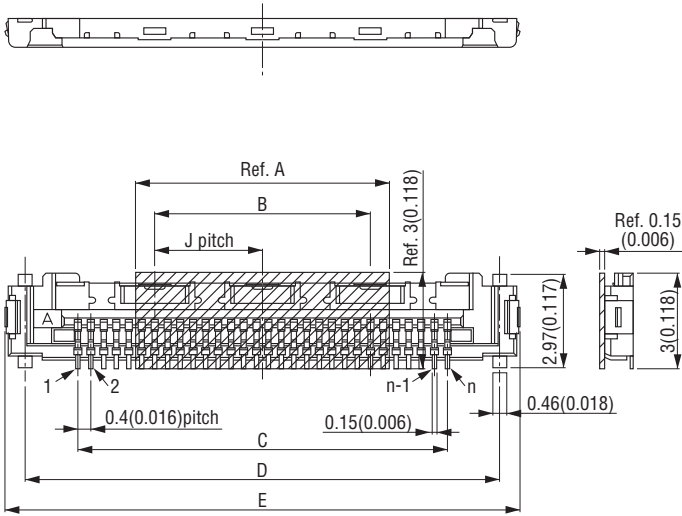
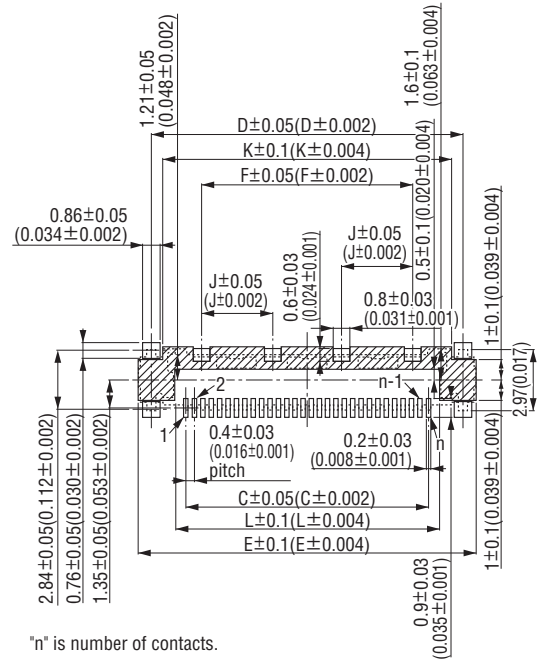
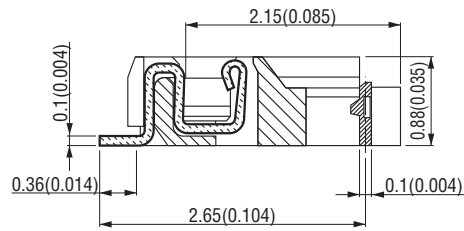
▶ Printed Circuit Board layout (Component side view)

X-X' Cross section

Packaging style

Embossed tape

▶ Product table

Part number	Number of packaging
USLS00-□□-A	500
USLS00-□□-B	1,000
USLS00-□□-C	3,000

▶ Product table / Dimensions

No. of contacts	Part number	A	B	C	D	E	F	G	H	J	K	L
20	USLS00-20-□	5.0 (0.197)	3.1 (0.122)	7.6 (0.299)	10.91 (0.430)	12.14 (0.478)	6.2 (0.244)	0.60 (0.024)	0.6 (0.024)	3.1 (0.122)	9.8 (0.386)	8.6 (0.339)
30	USLS00-30-□	8.0 (0.315)	6.8 (0.268)	11.6 (0.457)	14.91 (0.587)	16.14 (0.635)	10.1 (0.398)	0.75 (0.030)	0.8 (0.031)	3.4 (0.134)	13.8 (0.543)	12.6 (0.496)
40	USLS00-40-□	8.0 (0.315)	10.5 (0.413)	15.6 (0.614)	18.91 (0.744)	20.14 (0.793)	14.0 (0.551)	0.80 (0.031)	0.8 (0.031)	3.5 (0.138)	17.8 (0.701)	16.6 (0.654)

USLS20-□□ (Plug, Cable side connector)

Unit : mm(inch)

USLS20-□□ Base

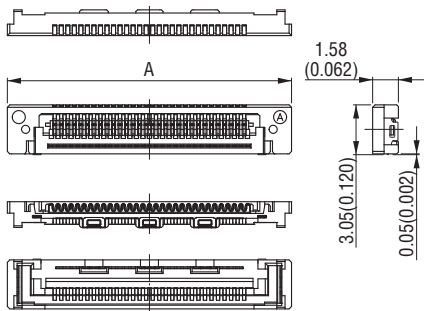

USLS20-□□ CV

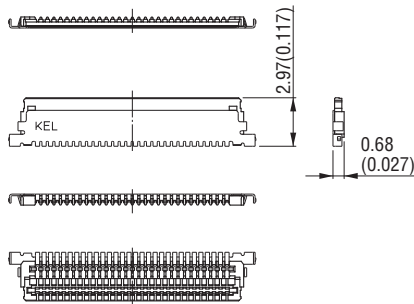

*USLS20-□□Base and USLS20-□□CV are component parts of USLS20-□□.

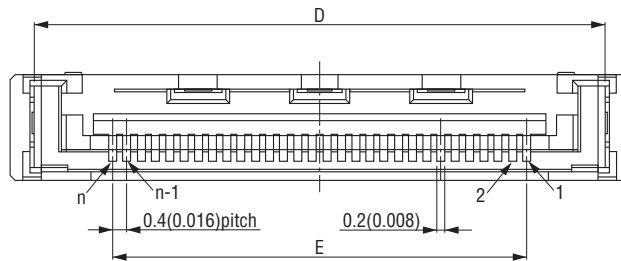
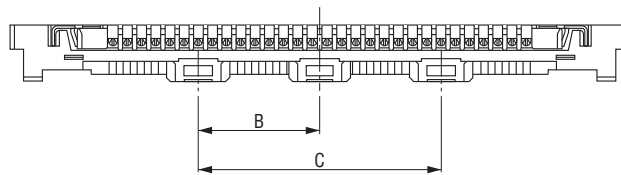
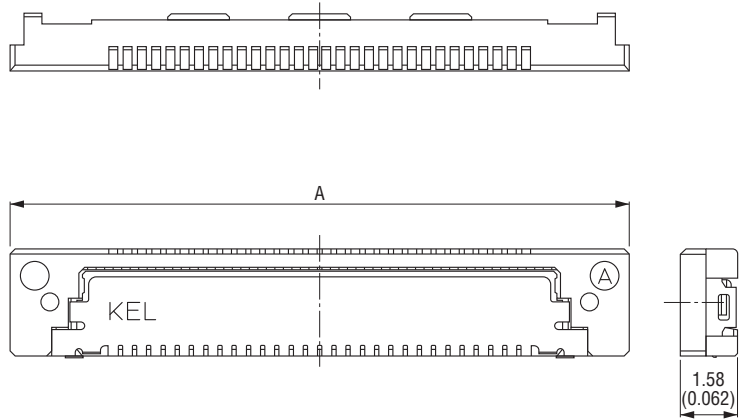

"n" is number of contacts.

Packaging style

Tray

Product table / Dimensions

No. of contacts	Part number	A	B	C	D	E	Number of packaging
20	USLS20-20	13.4 (0.528)	3.1 (0.122)	—	12.0 (0.472)	7.6 (0.299)	160
30	USLS20-30	17.4 (0.685)	3.4 (0.134)	6.8 (0.268)	16.0 (0.630)	11.6 (0.457)	120
40	USLS20-40	21.4 (0.843)	3.5 (0.138)	10.5 (0.413)	20.0 (0.787)	15.6 (0.614)	100

Cable assembly

ORDER CODE

USLS20 - - . - ()

1
 2
 3
 4
 5
 6
 7

- | | |
|---|---|
| <p>① [Type] USLS20 : Plug (Cable side connector)</p> <p>② [Number of contacts] 20 : 20 pin 30 : 30 pin 40 : 40 pin</p> <p>③ [Cable length (cm)] L : Dimension(Example : 013.5=13.5cm)</p> <p>④ [Wiring code] B : Pin 1 to Pin 1 C : Pin 1 to Pin n</p> | <p>⑤ [Laminated tape] No code : Without tape H : With tape</p> <p>⑥ [Quantity] (B) : 10 to 49pcs (C) : 50 to 99pcs (D) : 100pcs or more</p> <p>⑦ [Cable classification] Y: Standard No code: Upon request</p> |
|---|---|
- *Applicable cable length : 4 to 100cm Minimum cable length for USLS20-□□-□□□□-□-□-□□(□) : 7cm

▶ Cable assembly style

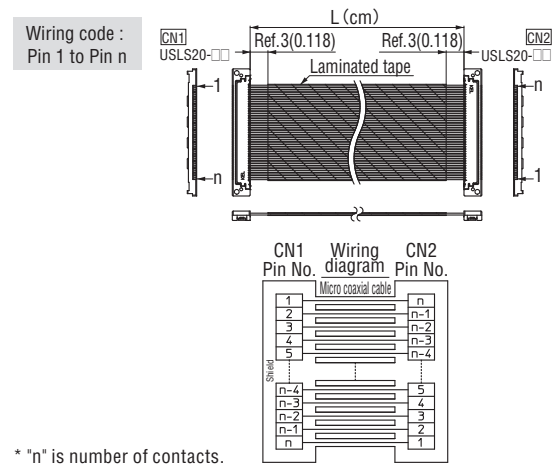
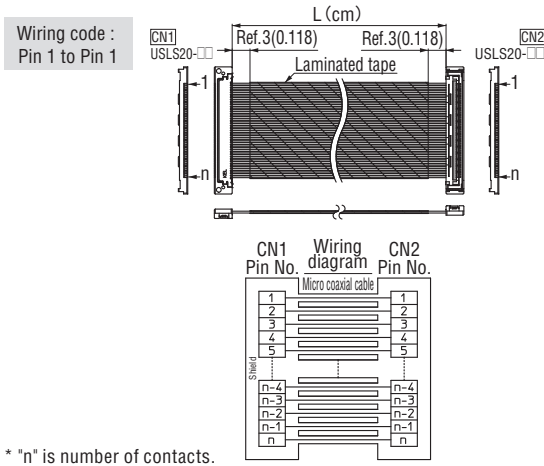

*Please contact your local KEL sales office for inquiries regarding cable length and tolerance.
 *Laminated tape is designed to be a little wider than the cable width. Please contact your local KEL sales office for further details.

ORDER CODE

USL+S20 - - . - ()

1
 2
 3
 4
 5
 6
 7

- | | |
|---|--|
| <p>① [Type] USL+S 20 : Plug (Cable side connector) Left side connector, CN1 / USL20 series</p> <p>② [Number of contacts] 20 : 20 pin 30 : 30 pin 40 : 40 pin</p> <p>③ [Cable length (cm)] L : Dimension(Example : 013.5=13.5cm)</p> <p>④ [Wiring code] B : Pin 1 to Pin 1 C : Pin 1 to Pin n</p> <p>⑤ [Laminated tape] No code : Without tape H : With tape</p> <p>⑥ [Quantity] (B) : 10 to 49pcs (C) : 50 to 99pcs (D) : 100pcs or more</p> <p>⑦ [Cable classification] Y: Standard No code: Upon request</p> | <p>Right side connector, CN2 / USLS20 series</p> |
|---|--|
- *Applicable cable length : 4 to 100cm Minimum cable length for USL+S20-□□-□□□□-□-□-□□(□) : 7cm

▶ Cable assembly style

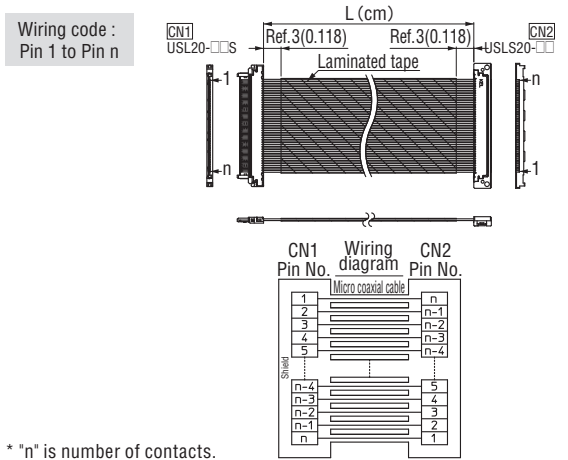
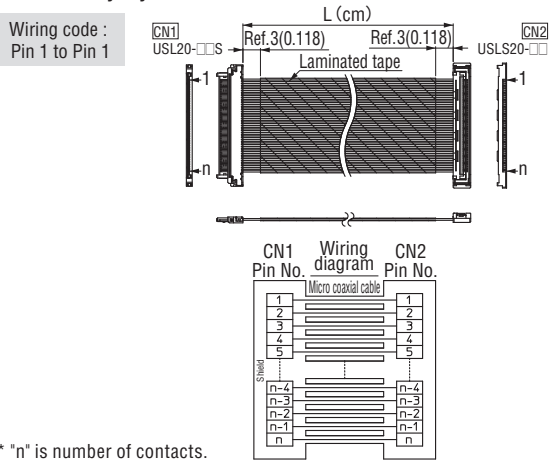

*Please contact your local KEL sales office for inquiries regarding cable length and tolerance.
 *Laminated tape is designed to be a little wider than the cable width. Please contact your local KEL sales office for further details.

USLS21 SERIES

RoHS
Compliant

0.4mm PITCH CONNECTOR FOR MICRO COAXIAL CABLE /SOLDERED CONNECTION (STACKING TYPE)

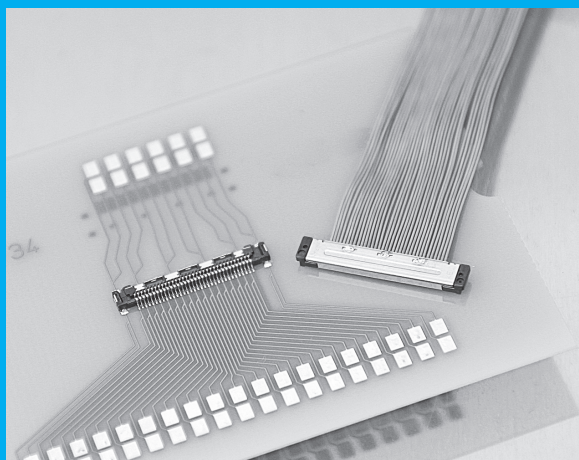

FEATURES

- ▶ Compact connector with a low profile of 1.65 mm(0.065") and a mating width of 3.05 mm(0.120").
- ▶ For micro coaxial cable(#40 AWG, #42 AWG, #44 AWG, #46 AWG).
- ▶ Provided with a soldered cable connection.
- ▶ Equipped with a metal shell, noise reduction and product strength are ensured.
- ▶ Multiple ground terminals are provided for enhanced transmission characteristics and EMS protection.
- ▶ Highly reliable design with effective mating length of 0.35mm(0.014").
- ▶ Nickel barrier of the board side contact prevents solder wicking.
- ▶ Possible to put through narrow tube with a diameter of ϕ 4m- ϕ 0.157") even after soldering.

ORDER CODE

USLS00-34- 

① ② ③

*Please order in multiples of the quantity per package.

- ① **[Type]** USLS00 : Receptacle (PCB side connector)
- ② **[Number of contacts]** 34 : 34 pin
- ③ **[Number of packing]** A : 500pcs. per reel B : 1,000pcs. per reel C : 3,000pcs. per reel

ORDER CODE

USLS21-34

① ②

*Please order in multiples of the quantity per package.

- ① **[Type]** USLS21 : Plug (Cable side connector) soldered cable connection type
- ② **[Number of contacts]** 34 : 34 pin

*Plug(cable side connector) is composed of a base and a shell.

SPECIFICATIONS

Material and finish		Electrical characteristics	
Insulator material	Glass-filled LCP(UL94V-0),Black	Rated current	0.25A per contact
Contact material	Copper alloy	Contact resistance	100m Ω max.
Contact plating	Gold over Nickel	Dielectric withstanding voltage	200V AC for 1minute
Shell material	[USLS00] Copper alloy	Insulation resistance	100M Ω min.at 250V DC
	[USLS21] Stainless	Operating temperature	-40°C to +85°C
Shell plating	Gold over Nickel	Applicable cable	#40/42/44/46 AWG Micro coaxial cables (Outermost diameter: max. 0.39 mm(0.015"))
Adsorption tape material	[USLS00] Polyimide		

Mating drawing

Unit : mm(inch)

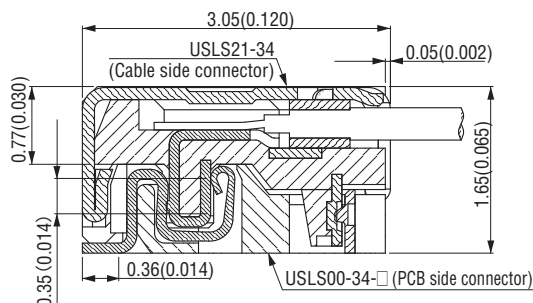

USLS00-34-□ (Receptacle, PCB side connector)

Unit : mm(inch)

▶ Printed Circuit Board layout (Component side view)

The metal shell is contact with diagonal line area.
Do not pattern in this area.
Ground mounting is recommended.

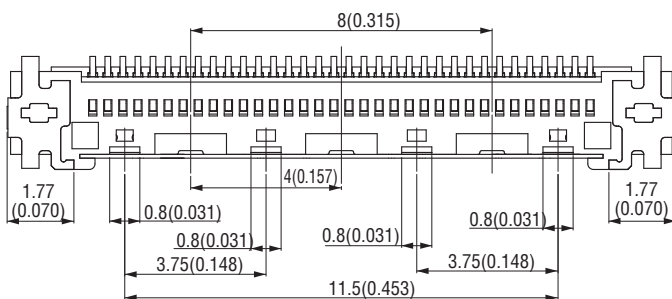
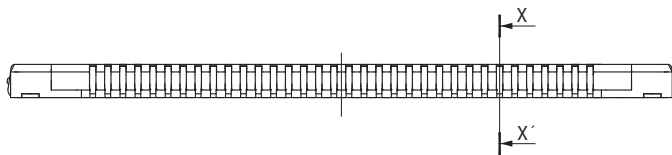
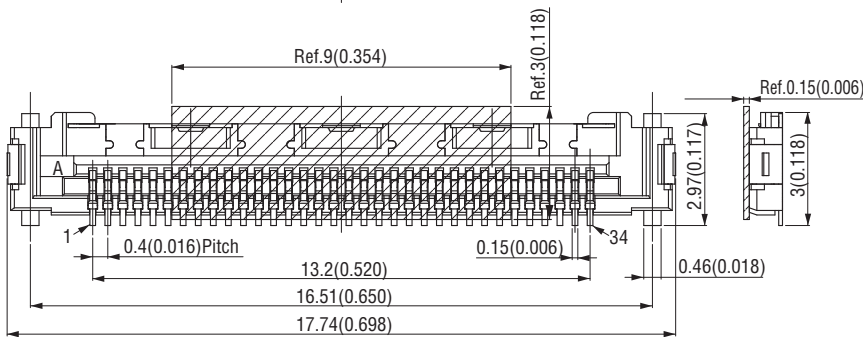
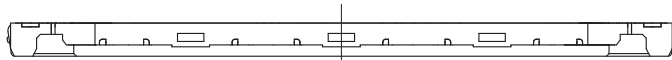
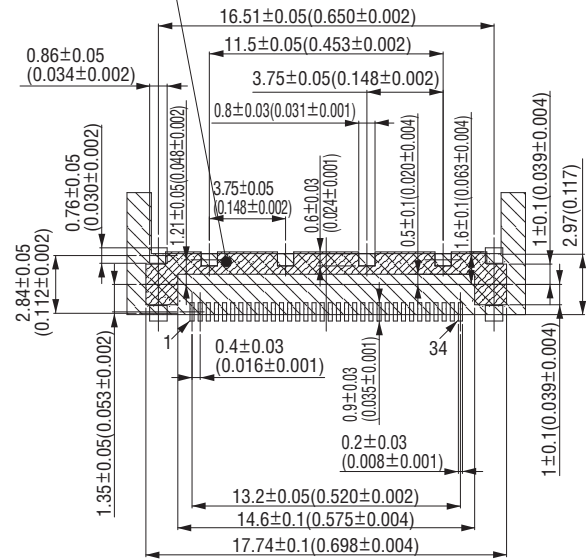

X-X' Cross section

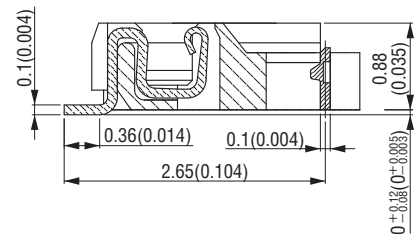

Packaging style
Embossed tape

▶ Product table

Part number	Number of packaging
USLS00-34-A	500
USLS00-34-B	1,000
USLS00-34-C	3,000

USLS21-34 (Plug, Cable side connector)

Unit : mm(inch)

USLS21-34BASE

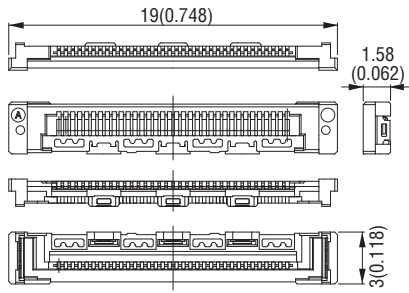

Number of packaging
5,000

USLS21-34SHELL

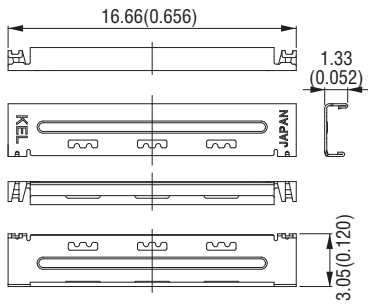

Number of packaging
10,000

*USLS21-34BASE and USL20-34SHELL are component parts of USL21-34.

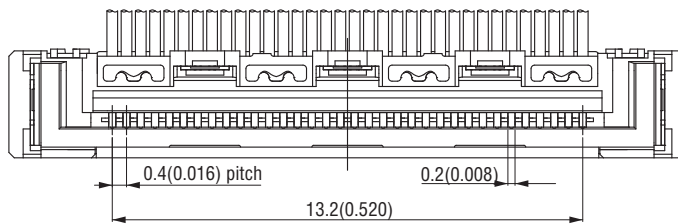
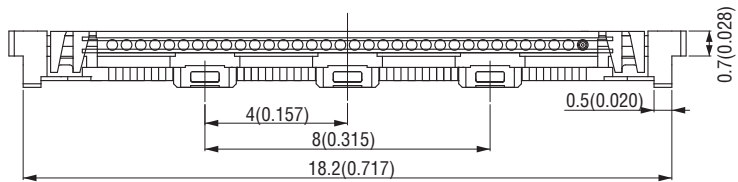
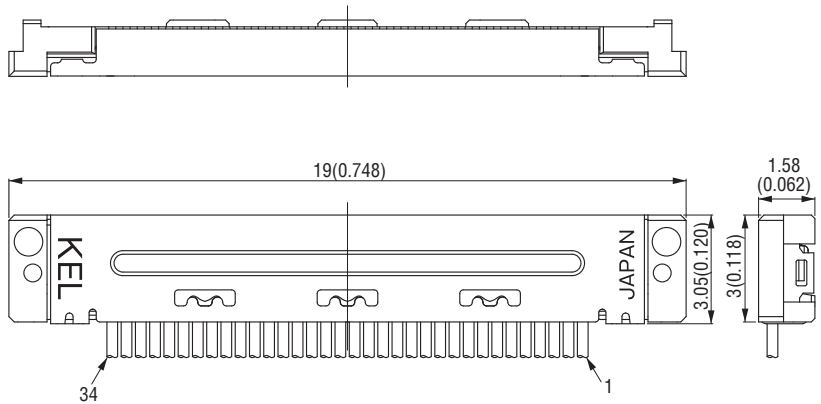

Packaging style



Other

Product table

No. of contacts	Part number	Number of packaging
34	USLS21-34	10,000

Looking for pricing, stock, or lifecycle information?

Click below to explore more details on WIN SOURCE:

-  [View XSLS00-30-A on WIN SOURCE](#)
-  [KEL Corporation Information](#)

Optimize Your Supply Chain with WIN SOURCE Solutions

-  Global Sourcing Solution
-  Obsolete Management
-  Cost Control Management
-  Shortage Management
-  Alternative Solution
-  Excess Inventory Management