

## Ultra-low power, high performance, sub-1 GHz transceiver



Maturity status link

S2-LP

### Features

- Frequency bands:
  - 413-479 MHz (S2-LPQTR)
  - 452-527 MHz (S2-LPCBQTR)
  - 826-958 MHz (S2-LPQTR)
  - 904-1055 MHz (S2-LPCBQTR)
- Modulation schemes:
  - 2(G)FSK, 4(G)FSK
  - OOK, ASK
- Air data rate from 0.1 to 500 kbps
- Ultra-low power consumption:
  - 7 mA RX
  - 10 mA TX @ +10 dBm
- Excellent performance of receiver sensitivity: down to -130 dBm
- Excellent receiver selectivity and blocking
- Programmable RF output power up to +16 dBm
- Programmable RX digital filter
- Programmable channel spacing
- Fast start-up and frequency synthesizer settling time
- Automatic frequency offset compensation, AGC and symbol timing recovery
- More than 145 dB RF link budget
- Battery indicator and low battery detector
- RX and TX 128 bytes FIFO buffers
- 4-wire SPI interface
- Automatic packet acknowledgment and retransmission
- Embedded timeout protocol engine
- Excellent receiver selectivity (> 80 dB @ 2 MHz)
- ST companion integrated balun/filter chips are available
- Antenna diversity algorithm
- Fully integrated ultra-low power RC oscillator
- Wake-up driven by internal timer or external event
- Digital real time RSSI
- Flexible packet length with dynamic payload length
- Programmable preamble and SYNC word quality filtering and detection
- Embedded CSMA/CA engine based on listen-before-talk systems
- IEEE 802.15.4g hardware packet support with whitening, FEC, CRC and dual SYNC word detection
- Wireless M-BUS supported
- KNX-RF supported
- Enables operations in the SIGFOX™ and MONARCH networks

- Suitable to build systems targeting:
  - **Europe:** ETSI EN 300 220, category 1.5 natively compliant, ETSI EN 303 131
  - **US:** FCC part 15 and part 90
  - **Japan:** ARIB STD T67, T108
  - **China:** SRRC
- Operating temperature range: -40 °C to +105 °C

## Applications

- Sensors to Cloud
- Smart metering
- Home energy management systems
- Wireless alarm systems
- Smart home
- Building automation
- Industrial monitoring and control
- Smart lighting systems

---

## 1 Description

---

The **S2-LP** is a high performance ultra-low power RF transceiver, intended for RF wireless applications in the sub-1 GHz band. It is designed to operate in both the license-free ISM and SRD frequency bands at 433, 512, 868 and 920 MHz, but can also be programmed to operate at other additional frequencies in the 413-479 MHz, 452-527 MHz, 826-958 MHz, 904-1055 MHz bands.

The **S2-LP** supports different modulation schemes: 2(G)FSK, 4(G)FSK, OOK and ASK. The air data rate is programmable from 0.1 to 500 kbps.

The **S2-LP** can be used in systems with channel spacing down to 1 kHz enabling the narrow band operations.

The **S2-LP** shows an RF link budget higher than 140 dB for long communication ranges and meets the regulatory requirements applicable in territories worldwide, including Europe, Japan, China and the USA.

## 2 Detailed functional description

The S2-LP integrates a configurable baseband modem with proprietary fully programmable packet format allowing also:

- IEEE 802.15.4g applications
  - The hardware packet supports whitening, CRC, FEC and dual SYNC word detection.
- Wireless M-Bus applications

In order to reduce the overall system power consumption and increase the communication reliability, the S2-LP provides an embedded programmable automatic packet acknowledgment, automatic packet retransmission, CSMA/CA engine, low duty cycle protocol, RX sniff mode and timeout protocol.

The S2-LP fully supports antenna diversity with an integrated antenna switching control algorithm.

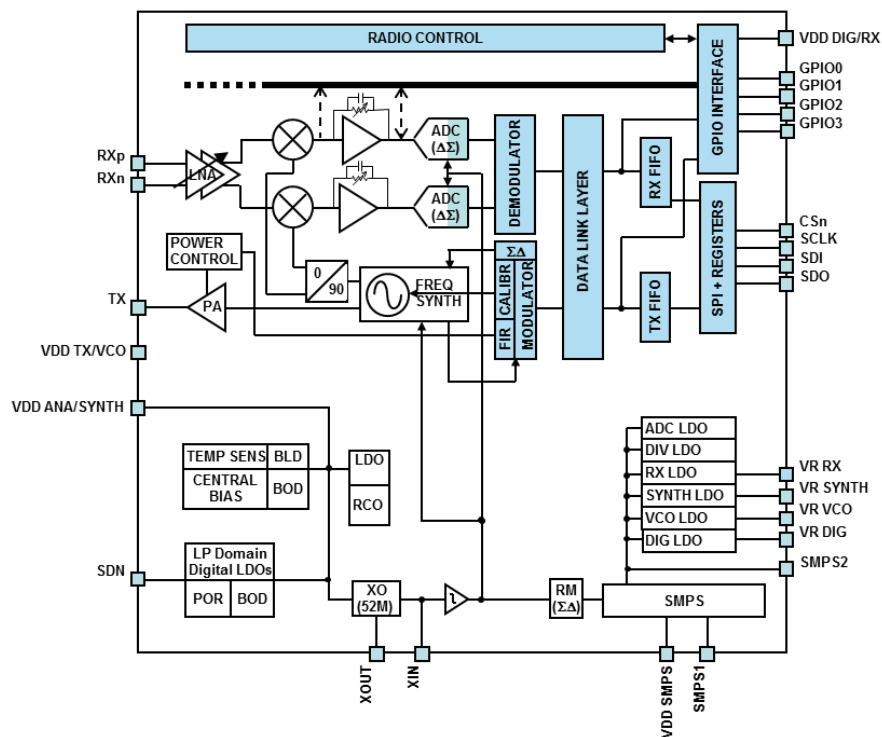
Transmitted/received data bytes are buffered in two different 128 bytes FIFOs (TX FIFO and RX FIFO), accessible via SPI interface for host processing.

In addition, the reduced number of external components enables a cost effective solution permitting a compact PCB footprint.

The S2-LP targets volume applications like:

- Sensors to Cloud
- Smart metering
- Home energy management systems
- Wireless alarm systems
- Smart home
- Building automation
- Industrial monitoring and control

**Figure 1. Simplified S2-LP block diagram**



The receiver architecture is low-IF conversion, the received RF signal is amplified by a two-stage low-noise amplifier (LNA) and down-converted in quadrature (I and Q) to the intermediate frequency (IF). LNA and IF amplifiers make up the RX front-end (RXFE) and have programmable gain. At IF, the ADCs digitalize the I/Q signals. The demodulated data go to an external MCU either through the 128-byte RX FIFO, readable via SPI, or directly using a programmable GPIO pin.

The transmitter part of the S2-LP is based on direct synthesis of the RF frequency. The power amplifier (PA) input is the LO generated by the RF synthesizer, while the output level can be configured between -30 dBm and +14 dBm (+16 dBm in boost mode), at antenna level with 0.5 dB steps.

The data to be transmitted can be provided by an external MCU either through the 128-byte TX FIFO writable via SPI, or directly using a programmable GPIO pin. The S2-LP supports frequency hopping, TX/RX and antenna diversity switch control, extending the link range and improving performance.

The S2-LP has a very efficient power management (PM) system. An integrated switched mode power supply (SMPS) regulator allows operation from a battery voltage ranging from +1.8 V to +3.6 V, and with power conversion efficiency of 90%.

A crystal must be connected between XIN and XOUT. It is digitally configurable to operate with different crystals. As an alternative, an external clock signal can be used to feed XIN for proper operation. The S2-LP also has an integrated low-power RC oscillator, generating the 34.7 kHz signal used as a clock for the slowest timeouts.

A standard 4-pin SPI bus is used to communicate with the external MCU. Four configurable general purpose I/Os are available.

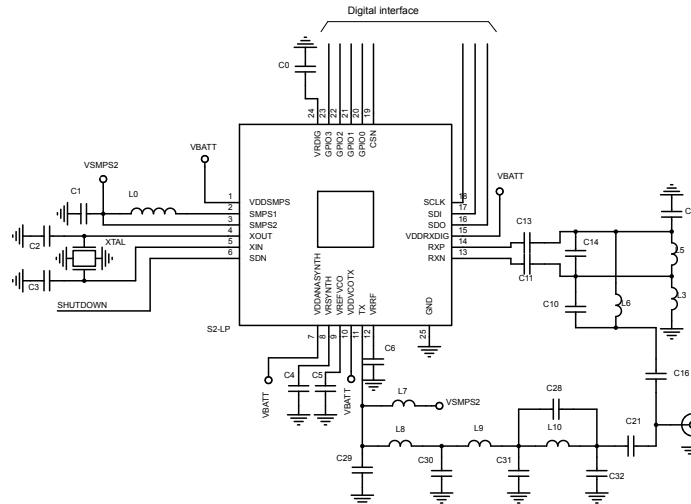
### 3 Typical application diagram and pin description

This section describes three different application diagrams for the S2-LP. Two main configurations are available:

- HPM (high performance mode) configuration
- LPM (low power mode) configuration

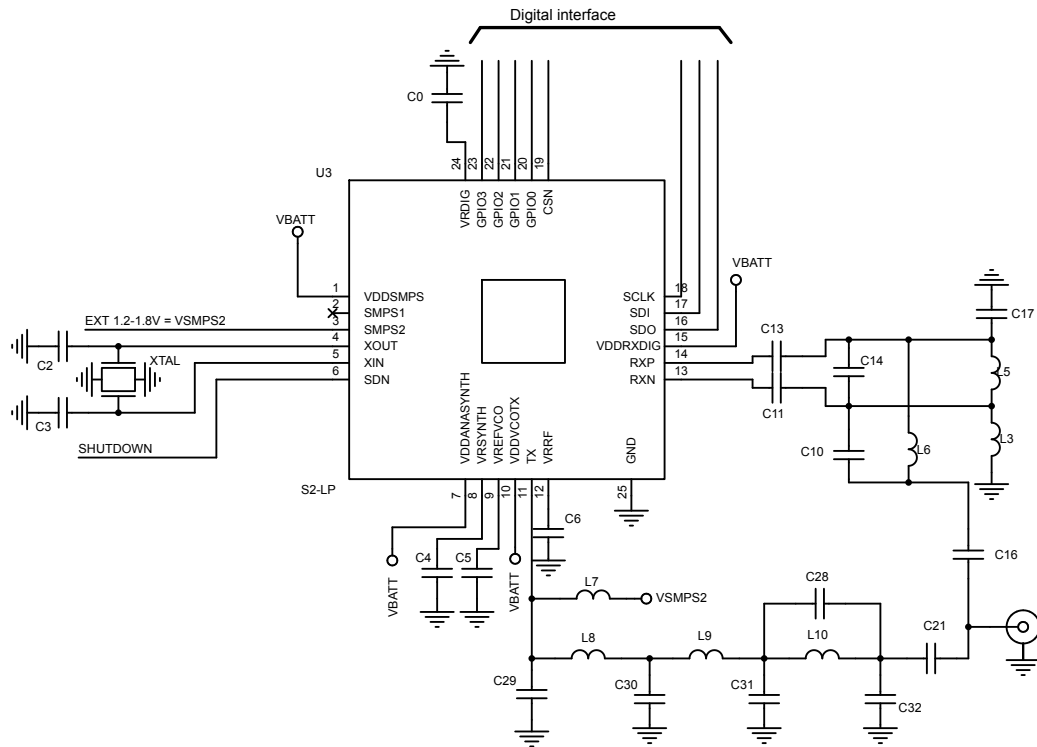
In the LPM operating mode the LDOs are bypassed and the SMPS provides the regulator voltage at 1.2 V. Note that in LPM the PA is supplied from SMPS at 1.2 V (instead of 1.5 V as in HPM), so the max. output power is lower than HPM. The figure below shows the suggested configuration with discrete matching network and SMPS-ON.

**Figure 2. Suggested application diagram (embedded SMPS used)**

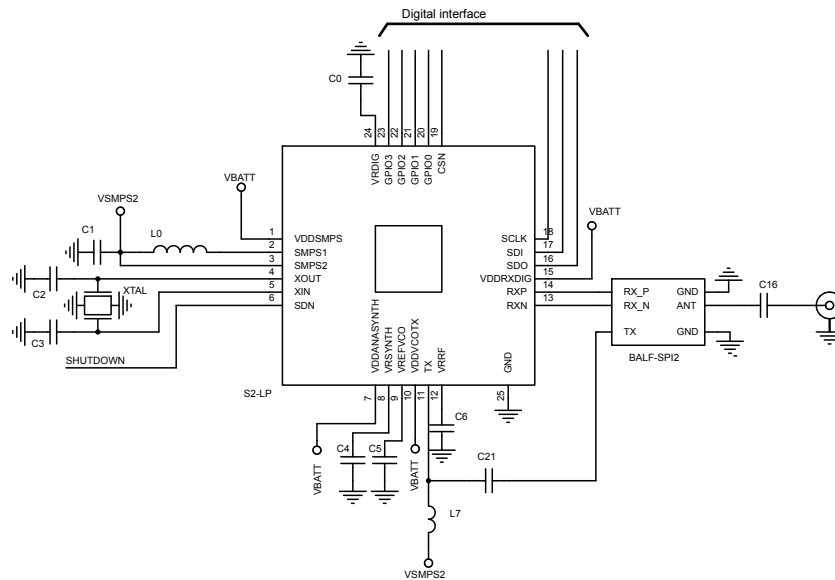


**Figure 3. Suggested application diagram (embedded SMPS not used)** shows the suggested configuration with discrete matching network and SMPS-OFF mode.

**Figure 3. Suggested application diagram (embedded SMPS not used)**



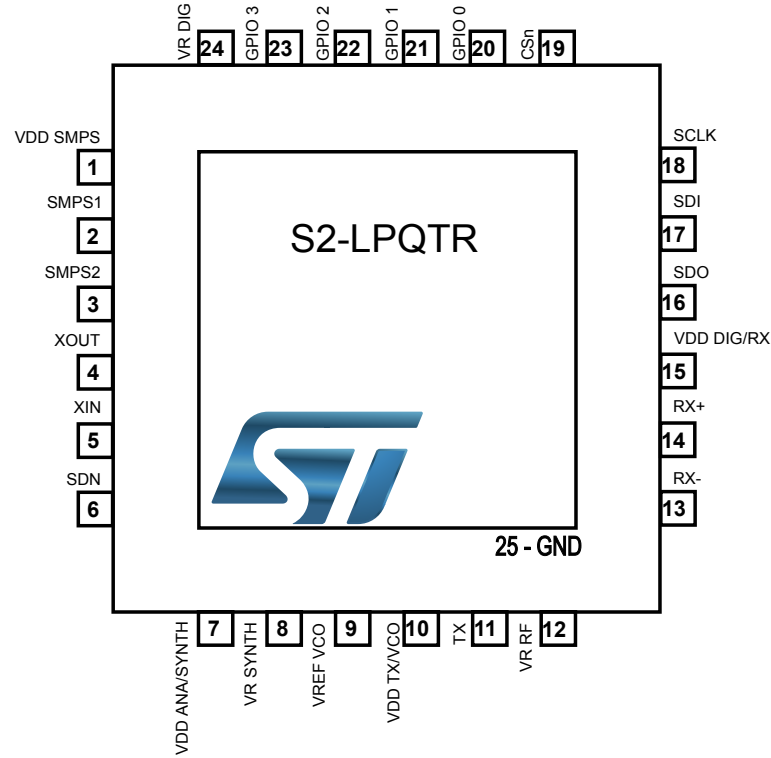
**Figure 4. Suggested application diagram HPM/LPM (integrated balun, embedded SMPS used)**



**Table 1. Description of the external components of the typical application diagrams**

Components	HPM/LPM discrete balun		HPM/LPM integrated balun	Description
	SMPS ON	SMPS OFF		
C0	X	X	X	Decoupling capacitor for on-chip voltage regulator to digital part
C1	X	-	X	SMPS LC filter capacitors
C2, C3	X	X	X	Crystal loading capacitors
C4	X	X	X	Decoupling capacitor for on-chip voltage regulator to synthesizer (LF part)
C5	X	X	X	Decoupling capacitor for band-gap voltage reference of VCO regulator
C6	X	X	X	Decoupling capacitor for on-chip voltage regulator to LNA-MIXER
C29, C30, C31, C32	X	X	-	TX LC filter/matching capacitors
C11, C13	X	X	-	DC blocking capacitors
C16, C21	X	X	X	-
C10, C14, C17	X	X	-	RF balun/matching capacitors
L0	X	-	X	SMPS LC filter inductor
L7	X	X	X	RF choke inductor or resonating inductor (upon RF network topology)
L8, L9, L10	X	X	-	TX LC filter/matching inductors
L3, L5, L6	X	X	-	RX balun/matching inductors
XTAL	X	X	X	Crystal

### 3.1 Pin diagram

**Figure 5. Pin diagram, QFN24 (4x4 mm) package**


### 3.2 Pin description

**Table 2. Pinout**

Number	Pin name	Pin type	Description
1	VDD SMPS	Power	1.8 V to 3.6 V analog power supply for SMPS only.
2	SMPS1	Analog out	1.1 V to 1.8 V SMPS regulator output to be externally filtered
3	SMPS2	Analog in	1.1 V to 1.8 V SMPS voltage input after LC filtering applied to SMPS1 output
4	XOUT	Analog out	Crystal oscillator output. Connect to an external crystal or leave floating if driving the XIN pin with an external clock source
5	XIN	Analog in	Crystal oscillator input. Connect to an external crystal or to an external clock source. If using an external clock source, DC coupling with a minimum 0.2 VDC level is recommended and minimum AC amplitude of 400 mVpp (however, the instantaneous level at input cannot exceed the 0 – 1.4 V range)
6	SDN	Digital in	Shutdown input pin. SDN should be = '0' in all modes, except shutdown mode
7	VDD ANA/ SYNTH	Power	1.8 V to 3.6 V power
8	VR SYNTH	Analog in/out	1.2 V SYNTH-LDO output for decoupling
9	VREF VCO	Analog out	1.2 V VCO-LDO band-gap reference voltage decoupling
10	VDD VCO/TX	Power	1.8 V to 3.6 V power supply
11	TX	RF output	RF output signal
12	VR RF	Analog in/out	1.2 V RX-LDO output for decoupling
13	RXn	RF in	Differential RF input signals for the LNA

Number	Pin name	Pin type	Description
14	RXp	RF in	Differential RF input signals for the LNA
15	VDD RX/DIG	Power	1.8 V to 3.6 V power supply
16	SDO	Digital out	SPI slave data output
17	SDI	Digital in	SPI slave data input
18	SCLK	Digital in	SPI slave clock input
19	CSn	Digital in	SPI chip select
20	GPIO0	Digital I/O	General purpose I/O that may be configured through the SPI registers to perform various functions
21	GPIO1	Digital I/O	
22	GPIO2	Digital I/O	
23	GPIO3	Digital I/O	
24	VR DIG	Analog in/out	1.2 V digital power supply output for decoupling
25	GND	Ground	Exposed pad connected to the ground of the application board

## 4 Specifications

### 4.1 Absolute maximum ratings

Absolute maximum ratings are those values above which damage to the device may occur. Functional operation under these conditions is not implied. All voltages refer to GND.

**Table 3. Absolute maximum ratings**

Parameter	Min.	Typ.	Max.	Unit
Supply and SMPS pins	-0.3	-	+3.9	V
DC voltage on VREG pins	-0.3	-	+3.9	
DC voltage on digital input pins	-0.3	-	+3.9	
DC voltage on digital output pins	-0.3	-	+3.9	
DC voltage on ground pins	-0.3	-	+3.9	
DC voltage on analog pins	-0.3	-	+1.8	
DC voltage on TX pin	-0.3	-	+3.9	
Storage temperature range	-40	-	+125	°C
VESD-HBM	-	-	1000 <sup>(1)</sup>	V

1. The TX pin can sustain 700 V maximum.

### 4.2 Operating range

**Table 4. Operating range**

Parameter	Min.	Typ.	Max.	Unit
Operating battery supply voltage ( $V_{BAT}$ )	1.8 <sup>(1)</sup>	3.0	3.6	V
Operating ambient temperature range	-40	25	+105	°C

1. 2 V when the device works in boost mode with SMPS ON.

### 4.3 Thermal properties

**Table 5. Thermal data**

Parameter	QFN24	Unit
Thermal resistance junction-ambient	66	°C/W

### 4.4 Power consumption

Characteristics measured over recommended operating conditions unless otherwise specified. Typical values are referred to 25 °C temperature,  $V_{BAT} = 3.3$  V. All performance is referred to the STEVAL-FKI433V2 or STEVAL-FKI868V2 with a 50 Ohm antenna connector.

**Table 6. Low-power state power consumption**

Parameter	Test conditions	Min.	Typ.	Max.	Unit
Supply current	Shutdown	-	2.5	-	nA
	Standby		500		

Parameter	Test conditions	Min.	Typ.	Max.	Unit
Supply current	Sleep	-	700	-	nA
	Sleep (FIFOs retained)		0.95		μA
	Ready		350		

**Table 7. Power consumption in reception TA = 25 °C, VDD = 3.3 V, fc = 868 MHz**

Parameter	Test conditions	Min.	HPM typ.	LPM typ.	Max.	Unit
Supply current	RX @ sensitivity level	-	8.6	7.2	-	mA
	RX in sniff mode @ 1.2 kbps <sup>(1)</sup>		0.9	-		
	RX in sniff mode @ 38.4 kbps <sup>(2)</sup>		0.8	-		
	RX in LDC mode @ 1.2 kbps <sup>(3)</sup>	-	21	-	-	μA
	RX in LDC mode @ 38.4 kbps <sup>(4)</sup>		3		-	

- Using 2-FSK,  $FREQDEV = 2.4$  kHz,  $DR=1.2$  kbps, 4 bytes preamble and 8 kHz ch. filter. Where the receiver wakes up at regular intervals to look for an incoming packet.
- Using 2-FSK,  $FREQDEV = 20$  kHz,  $DR=38.4$  kbps, 24 bytes preamble and 100 kHz ch. filter. Where the receiver wakes up at regular intervals to look for an incoming packet.
- Check for data packet every 1 second in LDC mode. 2-FSK,  $FREQDEV = 1.2$  kHz DEV and 8 kHz ch. filter,  $DR=1.2$  kbps, internal RC oscillator used as sleep timer. Sniff timer enabled.
- Check for data packet every 1 second in LDC mode. 2-FSK,  $FREQDEV = 20$  kHz,  $DR=38.4$  kbps and 100 kHz ch. filter, internal 34.6 kHz RC oscillator used as sleep timer. Sniff timer enabled.

**Table 8. Power consumption in transmission fc= 915 MHz**

Parameter	Test conditions	Min.	Typ.	Max.	Unit
Supply current	TX CW @ 14 dBm	-	22	-	mA
	TX CW @ 10 dBm <sup>(1)</sup>	-	12.5	-	
	TX CW @ 16 dBm in Boost <sup>(2)</sup>	-	32	-	-

- SMPS output voltage 1.2 V, LDOs disable.
- SMPS output voltage 1.8 V.

**Table 9. Power consumption in transmission fc= 840-868 MHz**

Parameter	Test conditions	Min.	Typ.	Max.	Unit
Supply current	TX CW @ 14 dBm	-	20	-	mA
	TX CW @ 10 dBm <sup>(1)</sup>	-	11.5	-	
	TX CW @ 16 dBm in Boost <sup>(2)</sup>	-	29	-	-

- SMPS output voltage 1.2 V, LDOs disable.
- SMPS output voltage 1.8 V.

**Table 10. Power consumption in transmission fc= 434 MHz**

Parameter	Test conditions	Min.	Typ.	Max.	Unit
Supply current	TX CW @ 14 dBm <sup>(1)</sup>	-	21	-	mA
	TX CW @ 10 dBm <sup>(2)</sup>	-	11.5	-	

- SMPS output voltage 1.6 V.
- SMPS output voltage 1.2 V, LDOs disable.

**Table 11. Power consumption in transmission  $f_c = 510$  MHz**

Parameter	Test conditions	Min.	Typ.	Max.	Unit
Supply current	TX CW @ 14 dBm	-	19	-	mA
	TX CW @ 10 dBm <sup>(1)</sup>	-	12	-	
	TX CW @ 15 dBm <sup>(2)</sup>	-	27	-	

1. SMPS output voltage 1.2 V, LDOs disable.
2. SMPS output voltage 1.8 V.

## 4.5 General characterization

**Table 12. General characteristics**

Parameter		Typ.	Unit
Frequency range		413 - 479	MHz
		452-527	
		826 - 958	
		904-1055	
Data rate DR	2-(G)FSK	0.1 - 250	kbps
	4-(G)FSK	0.2 - 500	
	OOK/ASK	0.1 -125	
Data rate accuracy		±100	ppm
Frequency deviation FDEV		0.15 - 500	kHz

If "Manchester" or "3-out-of-6" or FEC coding options are enabled the actual bit rate is affected as follows:

**Table 13. Data rate with different coding options**

Coding option	2GFSK[kbps]	4GFSK[kbps]
NRZ	250	500
FEC	125	250
Manchester	125	Not supported
3-out-of-6	166.6	Not supported

## 4.6 Frequency synthesizer

**Table 14. Frequency synthesizer parameters**

Parameter	Test conditions	50 MHz	Unit
		Frequency step size	Out-loop divider ratio = 4
RF carrier phase noise 433 MHz	10 kHz	-109	dBc/Hz
	100 kHz	-110	
	1 MHz	-124	
	10 MHz	-141	
RF carrier phase noise 510 MHz	10 kHz	-108	

Parameter	Test conditions	50 MHz	Unit
RF carrier phase noise 510 MHz	100 kHz	-109	dBc/Hz
	1 MHz	-124	
	10 MHz	-140	
RF carrier phase noise 868 MHz	10 kHz	-102	
	100 kHz	-103	
	1 MHz	-117	
	10 MHz	-138	
RF carrier phase noise 915 MHz	10 kHz	-102	
	100 kHz	-102	
	1 MHz	-117	
	10 MHz	-138	

## 4.7 Crystal oscillator

Characteristics measured over recommended operating conditions unless otherwise specified. All typical values are referred to 25 °C temperature,  $V_{BAT} = 3.0$  V.

The device supports crystals in the range [24-26] MHz and [48-52] MHz.

If the crystal is in the [24–26] MHz range, both the analog and the digital parts must work at this frequency. Otherwise, if a crystal in the [48-52] MHz range is used, the analog part must work at this frequency and the digital part at this frequency divided by 2. From now on in this document the XTAL oscillator is indicated with  $f_{XO}$  and the digital clock with  $f_{dig}$ .

The divider for the digital part can be set by the PD\_CLKDIV bit of the XO\_RCO\_CONFIG1 in the following way:

- if a [48 – 52] MHz crystal is used, this bit must be 0 (digital divider enabled):

$$f_{dig} = \frac{f_{XO}}{2} \quad (1)$$

- if a [24 – 26] MHz crystal is used, this bit must be 1 (digital divider disabled):

$$f_{dig} = f_{XO} \quad (2)$$

The safest procedure to disable the divider without any risk of glitches in the digital clock is to switch into STANDBY mode, hence, disable the divider through register setting, and then come back to the READY state. In order to avoid potential RF performance degradations, the crystal frequency should be chosen to satisfy the following equation:

$$\left| nF_{CH} - \text{ROUND}\left(n\frac{F_{CH}}{f_{XO}}\right)f_{XO} \right| \geq 1\text{MHz} \quad (3)$$

where n is an integer in the set [1-7, B] (B is the synthesizer's divider ratio).

**Table 15. Crystal oscillator characteristics**

Parameter	Test conditions	Min.	Typ.	Max.	Unit
Crystal frequency	-	24	-	26	MHz
		48	-	52	
Frequency tolerance <sup>(1)</sup>	-	-	± 40	-	ppm
Minimum requirement on external reference phase noise mask $f_{XO} = 26$ MHz, to avoid degradation on synthesizer phase/noise	10 kHz	-	-	-135	dBc/Hz
	100 kHz	-	-	-140	
	1 MHz	-	-	-140	

Parameter	Test conditions	Min.	Typ.	Max.	Unit
Minimum requirement on external reference phase noise mask $f_{XO} = 26$ MHz, to avoid degradation on synthesizer phase/noise	10 MHz	-	-	-140	dBc/Hz
Programmable trans-conductance of the oscillator at start-up	-	13	-	43	mS
Start-up time <sup>(2)</sup>	V <sub>BAT</sub> =1.8 V, $f_{XO} = 26$ MHz	-	100	-	μs

1. Including initial tolerance, crystal loading, aging, and temperature dependence. The acceptable crystal tolerance depends on RF frequency and channel spacing/bandwidth.
2. Start-up times are crystal dependent. The crystal oscillator trans-conductance can be tuned to compensate the variation of crystal oscillator series resistance.

**Table 16. Ultra-low power RC oscillator**

Parameter	Test conditions	Typ.	Unit
Calibrated frequency	Calibrated RC oscillator frequency is derived from crystal oscillator frequency.	33.3 <sup>(1)</sup>	kHz
Frequency accuracy after calibration	-	±1	%

1. Depending on the crystal frequency, the reported value is referring to 50 MHz.

## 4.8 RF receiver

Characteristics measured over recommended operating conditions unless otherwise specified. All typical values are referred to 25 °C temperature, V<sub>BAT</sub> = 3.3 V, no frequency offset in the RX signal. The whole performance is referred to the STEVAL-FKI433V2, STEVAL-FKI512V1 or STEVAL-FKI868V2 with a 50 Ohm antenna connector.

**Table 17. RF receiver characteristics**

Parameter	Test conditions	HPM/LPMSMPS on typ.	Unit	
Receiver channel bandwidth CHF	-	1-800	kHz	
RX input return loss	Max. RX gain, tied (RX + TX) matching networks	433 MHz	-15	dB
		868 MHz	-15	
Saturation 1% BER	2-FSK 1.2 kHz FDEV, DR = 1.2 kbps, CHF = 4 kHz	433 MHz	10	dBm
		868 MHz	10	
Input third order intercept point	Interferers are continuous wave @ 6 MHz and 12 MHz offset from carrier	433 MHz	-25	dBm
		868 MHz	-25	
RX noise figure	Max. RX gain, tied (RX + TX) matching networks	433 MHz	8	dB
		868 MHz	8	
Differential input impedance at LNA	Max. RX gain R // C	433 MHz	200 // 1.5	Ω/pF
		868 MHz	200 // 1.5	

### 4.8.1 Blocking and selectivity at 433 MHz

**Table 18. Blocking and selectivity at 433 MHz**

Parameter	Test condition	HPM SMPS on (typ.)	LPM SMPS ON typ.	Unit
Selectivity and blocking 1% BER @ 2-GFSK BT=0.5 1.2 kHz FDEV, DR = 1.2 kbps, CHF = 4 kHz	+12.5 kHz (adjacent channel)	64	56	dB

Parameter	Test condition	HPM SMPS on (typ.)	LPM SMPS ON typ.	Unit
Selectivity and blocking 1% BER @ 2-GFSK BT=0.5 1.2 kHz FDEV, DR = 1.2 kbps, CHF = 4 kHz	-12.5 kHz (adjacent channel)	64	56	dB
	+25 kHz (alternate channel)	65	59	
	-25 kHz (alternate channel)	65	59	
	Image rejection	60	63	
	±2 MHz	81	81	
	±10 MHz	82	85	
Selectivity and blocking 1% BER @ 2-GFSK BT=0.5 20 kHz FDEV, DR = 38.4 kbps, CHF = 100 kHz	+100 kHz (adjacent channel)	50	37	dB
	-100 kHz (adjacent channel)	50	37	
	+200 kHz (alternate channel)	51	45	
	-200 kHz (alternate channel)	51	45	
	Image rejection	56	58	
	±2 MHz	67	67	
	±10 MHz	69	72	

#### 4.8.2 Sensitivity at 433 MHz

**Table 19. Sensitivity at 433 MHz**

Parameter	Test conditions	HPM/LPM SMPS on (typ.)	Unit
Sensitivity 1% BER @ 2-GFSK BT = 0.5	DR = 0.3 kbps, FDEV = 0.25 kHz, CHF = 1 kHz	-128	dBm
	DR = 1.2 kbps, FDEV = 1.2 kHz, CHF = 4 kHz	-122	
	DR = 38.4 kbps, FDEV = 20 kHz, CHF = 100 kHz	-109	
	DR = 250 kbps, FDEV = 125 kHz, CHF = 780 kHz	-101	
Sensitivity 1% BER @ 4-GFSK BT = 0.5	DR = 4.8 ksps, DEV = 2.4 kHz, CHF = 10 kHz	-114	dBm
	DR = 9.6 ksps, DEV = 4.8 kHz, CHF = 20 kHz	-111	
	DR = 19.2 ksps, DEV = 9.6 kHz, CHF = 40 kHz	-108	
Sensitivity 1% BER @ OOK	DR = 0.3 kbps, CHF = 1 kHz	-120	dBm
	DR = 1.2 kbps, CHF = 4 kHz	-118	
	DR = 38.4 kbps, CHF = 100 kHz	-104	
	DR = 125 kbps, CHF = 250 kHz	-100	

**4.8.3 Blocking and selectivity @ 510 MHz**
**Table 20. Blocking and selectivity @ 510 MHz**

Parameter	Test conditions	HPM SMPS on (typ.)	LPM SMPS on (typ.)	Unit
Selectivity and blocking 1% BER @ 2-GFSK BT = 0.5, 1.2 kHz FDEV, DR = 1.2 kbps, CHF = 4 kHz	+12.5 kHz (adjacent channel)	64	56	dB
	-12.5 kHz (adjacent channel)	65	56	
	+25 kHz (alternate channel)	64	59	
	-25 kHz (alternate channel)	65	59	
	Image rejection	60	63	
	± 2 MHz	81	81	
	± 10 MHz	82	85	
Selectivity and blocking 1% BER @ 2-GFSK BT = 0.5, 20 kHz FDEV, DR = 38.4 kbps, CHF = 100 kHz	+100 kHz (adjacent channel)	50	37	dB
	-100 kHz (adjacent channel)	50	37	
	+200 kHz (alternate channel)	51	45	
	-200 kHz (alternate channel)	51	45	
	Image rejection	56	58	
	± 2 MHz	67	67	
	± 10 MHz	69	72	

**4.8.4 Sensitivity at 510 MHz**
**Table 21. Sensitivity at 510 MHz**

Parameter	Test conditions	HPM/LPM SMPS on (typ.)	Unit
Sensitivity 1% BER @ 2-GFSK BT = 0.5	DR = 0.3 kbps, FDEV = 0.25 kHz, CHF = 1 kHz	-128	dBm
	DR = 1.2 kbps, FDEV = 1.2 kHz, CHF = 4 kHz	-122	
	DR = 38.4 kbps, FDEV = 20 kHz, CHF = 100 kHz	-109	
	DR = 250 kbps, FDEV = 125 kHz, CHF = 780 kHz	-101	
Sensitivity 1% BER @ 4-GFSK BT = 0.5	DR = 4.8 kbps, DEV = 2.4 kHz, CHF = 10 kHz	-114	dBm
	DR = 9.6 kbps, DEV = 4.8 kHz, CHF = 20 kHz	-111	
	DR = 19.2 kbps, DEV = 9.6 kHz, CHF = 40 kHz	-108	
Sensitivity 1% BER @ OOK	DR = 0.3 kbps, CHF = 1 kHz	-120	dBm
	DR = 1.2 kbps, CHF = 4 kHz	-118	
	DR = 38.4 kbps, CHF = 100 kHz	-104	
	DR = 125 kbps, CHF = 250 kHz	-100	

#### 4.8.5 Blocking and selectivity at 868 MHz

**Table 22. Blocking and selectivity @ 868 MHz**

Parameter	Test conditions	HPM SMPS on (typ.)	LPM SMPS on (typ.)	Unit
Selectivity and blocking 1% BER @ 2-GFSK BT = 0.5, 1.2 kHz FDEV, DR = 1.2 kbps, CHF = 4 kHz	+12.5 kHz (adjacent channel)	58	50	dB
	-12.5 kHz (adjacent channel)	58	50	
	+25 kHz (alternate channel)	59	51	
	-25 kHz (alternate channel)	59	51	
	Image rejection	58	60	
	± 2 MHz	81	81	
	± 10 MHz	82	86	
Selectivity and blocking 1% BER @ 2-GFSK BT = 0.5, 20 kHz FDEV, DR = 38.4 kbps, CHF = 100 kHz	+100 kHz (adjacent channel)	44	33	dB
	-100 kHz (adjacent channel)	44	33	
	+200 kHz (alternate channel)	45	39	
	-200 kHz (alternate channel)	45	39	
	Image rejection	50	55	
	± 2 MHz	67	70	
	± 10 MHz	69	73	

#### 4.8.6 Sensitivity at 868 MHz

**Table 23. Sensitivity at 868 MHz**

Parameter	Test conditions	HPM/LPM/SMPS on typ.	Unit
Sensitivity 1% BER @ 2-GFSK BT = 0.5	DR = 0.3 kbps, FDEV = 0.25 kHz, CHF = 1 kHz	-128	dBm
	DR = 1.2 kbps, FDEV = 1.2 kHz, CHF = 4 kHz	-122	
	DR = 38.4 kbps, FDEV = 20 kHz, CHF = 100 kHz	-109	
	DR = 250 kbps, FDEV = 125 kHz, CHF = 780 kHz	-101	
Sensitivity 1% BER @ 4-GFSK BT = 0.5	DR = 4.8 ksps, DEV = 2.4 kHz, CHF = 10 kHz	-114	dBm
	DR = 9.6 ksps, DEV = 4.8 kHz, CHF = 20 kHz	-111	
	DR = 19.2 ksps, DEV = 9.6 kHz, CHF = 40 kHz	-108	
Sensitivity 1% BER @ OOK	DR = 0.3 kbps, CHF = 1 kHz	-120	dBm
	DR = 1.2 kbps, CHF = 4 kHz	-118	
	DR = 38.4 kbps, CHF = 100 kHz	-104	
	DR = 125 kbps, CHF = 250 kHz	-100	

#### 4.8.7 Blocking and selectivity at 915 MHz

**Table 24. Blocking and selectivity at 915 MHz**

Parameter	Test condition	HPM/ SMPS on typ.	LPM/ SMPS on typ.	Unit
Selectivity and blocking 1% BER @ 2-GFSK BT=0.5 1.2 kHz FDEV, DR = 1.2 kbps, CHF = 4 kHz	+12.5 kHz (adjacent channel)	58	50	dB
	-12.5 kHz (adjacent channel)	58	50	
	+25 kHz (alternate channel)	59	51	
	-25 kHz (alternate channel)	59	51	
	Image rejection	58	60	
	±2 MHz	81	81	
	±10 MHz	82	86	
Selectivity and blocking 1% BER @ 2-GFSK BT=0.5 20 kHz FDEV, DR = 38.4 kbps, CHF = 100 kHz	+100 kHz (adjacent channel)	44	33	dB
	-100 kHz (adjacent channel)	44	33	
	+200 kHz (alternate channel)	45	39	
	-200 kHz (alternate channel)	45	39	
	Image rejection	50	55	
	±2 MHz	67	70	
	±10 MHz	69	73	

#### 4.8.8 Sensitivity at 915 MHz

**Table 25. Sensitivity at 915 MHz**

Parameter	Test conditions	HPM/LPM/SMPS on typ.	Unit
Sensitivity 1% BER @ 2-GFSK BT = 0.5	DR = 0.3 kbps, FDEV = 0.25 kHz, CHF = 1 kHz	-128	dBm
	DR = 1.2 kbps, FDEV = 1.2 kHz, CHF = 4 kHz	-122	
	DR = 38.4 kbps, FDEV = 20 kHz, CHF = 100 kHz	-109	
	DR = 250 kbps, FDEV = 125 kHz, CHF = 780 kHz	-101	
Sensitivity 1% BER @ 4-GFSK BT = 0.5	DR = 4.8 ksps, DEV = 2.4 kHz, CHF = 10 kHz	-114	dBm
	DR = 9.6 ksps, DEV = 4.8 kHz, CHF = 20 kHz	-111	
	DR = 19.2 ksps, DEV = 9.6 kHz, CHF = 40 kHz	-108	
Sensitivity 1% BER @ OOK	DR = 0.3 kbps, CHF = 1 kHz	-120	dBm
	DR = 1.2 kbps, CHF = 4 kHz	-118	
	DR = 38.4 kbps, CHF = 100 kHz	-104	
	DR = 125 kbps, CHF = 250 kHz	-100	

## 4.9 RF transmitter

Characteristics measured over recommended operating conditions unless otherwise specified. All typical values are referred to 25 °C temperature,  $V_{BAT} = 3.3$  V. All performance is referred to the STEVAL-FKI433V2 or STEVAL-FKI868V2 with a 50  $\Omega$  antenna connector.

**Table 26. RF transmitter characteristics**

Parameter	Test conditions	HPM typ.	LPM typ.	Unit
Maximum output power	CW @ antenna level	14	10	dBm
Maximum output power in boost mode	CW @ antenna level	16	12	
Minimum output power	CW @ antenna level	-30	-30	
Output power step	-10<=output power<=+10 dBm	0.5	0.5	dB
Output power step (1)	Output power>+10 dBm	1 <sup>(1)</sup>	-	

1. In this case the register 0x64 is set to 0x4A.

**Table 27. PA impedance**

Parameter	Test conditions	Typ.	Unit
Optimum load impedance	433 MHz	56+25j	$\Omega$
	510 MHz	24+14j	
	868 MHz	30+24j	
	920 MHz	29+23j	
Max permitted VSWR @ antenna level	433 MHz	2	-
	510 MHz	2	
	868 MHz	5	
	920 MHz	5	

**Table 28. Regulatory standards**

Frequency band	Suitable for compliance with:
413 - 479 MHz 452 - 527 MHz	ETSI EN300 220 category 1.5
	FCC part 15, FCC part 90
	ARIB STD-T67
	Chinese SRRC
826 - 958 MHz 904 - 1055 MHz	ETSI EN300 220-2 category 1.5
	FCC part 15
	ARIB STD-T108
	Chinese SRRC

### 4.9.1 Harmonic emission at 433 MHz

**Table 29. Harmonic emission at 433 MHz**

Parameter	Test conditions	SMPS on	Unit
H1	CW	14	dBm
H2	CW	-51	
H3	CW	-56	

Parameter	Test conditions	SMPS on	Unit
H4	CW	-39	dBm
H5	CW	-34	
H6	CW	-46	
H7	CW	-44	

#### 4.9.2 Harmonic emission at 510 MHz

**Table 30. Harmonic emission at 510 MHz**

Parameter	Test conditions	HPM/LPM/SMPS on	Unit
H1	CW	14	dBm
H2	CW	-38	
H3	CW	-34	
H4	CW	-44	
H5	CW	-36	
H6	CW	-44	
H7	CW	-55	

#### 4.9.3 Harmonic emission at 840-868 MHz

**Table 31. Harmonic emission at 840-868 MHz**

Parameter	Test conditions	HPM/LPM/SMPS on	Unit
H1	CW	14	dBm
H2	CW	-38	
H3	CW	-54	
H4	CW	-52	
H5	CW	-52	
H6	CW	-43	
H7	CW	-51	

#### 4.9.4 Harmonic emission at 915 MHz

**Table 32. Harmonic emission at 915 MHz**

Parameter	Test conditions	HPM/LPM/SMPS on	Unit
H1	CW	14	dBm
H2	CW	-46	
H3	CW	-55	
H4	CW	-46	
H5	CW	-49	
H6	CW	-48	
H7	CW	-51	

## 4.10 Digital interface specification

**Table 33. Digital SPI input, output and GPIO specification**

Parameter	Test conditions	Min.	Typ.	Max.	Unit
SPI clock frequency	-	-	8	10	MHz
Port I/O capacitance	-	-	1.4	-	pF
Rise time	From 0.1*VDD to 0.9*VDD, CL=20 pF (low output current programming)	-	6.0	-	ns
	From 0.1*VDD to 0.9*VDD, CL=20 pF (high output current programming)	-	2.5	-	-
Fall time	From 0.1*VDD to 0.9*VDD, CL=20 pF (low output current programming)	-	7.0	-	ns
	From 0.1*VDD to 0.9*VDD, CL=20 pF (high output current programming)	-	2.5	-	-
Logic high level input voltage	-	VDD/2 +0.3	-	-	V
Logic low level input voltage	-	-	-	VDD/8 +0.3	V
High level output voltage	I <sub>OH</sub> = -2.4 mA (-4.2 mA into high output current mode).	(5/8)* VDD+ 0.1	-	-	V
Low level output voltage	I <sub>OL</sub> = +2.0 mA (+4.0 mA into high output current mode).	-	-	0.5	V
CSn low to positive edge on SCLK in low power mode state	-	-	40	-	μs
CSn low to positive edge on SCLK in ready state	-	30	-	-	ns

## 4.11 Battery indicator

Characteristics measured over recommended operating conditions unless otherwise specified. All typical values are referred to 25 °C temperature, V<sub>BAT</sub> = 3.0 V.

**Table 34. Battery indicator and low battery detector**

Parameter	Test conditions	Min.	Typ.	Max.	Unit
Battery level thresholds #1	-	-	2.1	-	V
Battery level thresholds #2	-	-	2.3	-	
Battery level thresholds #3	-	-	2.5	-	
Battery level thresholds #4	-	-	2.7	-	
Brownout threshold	Measured in slow battery variation (static) conditions (inaccurate mode)	-	1.5	-	V
	Measured in slow battery variation (static) conditions (accurate mode)	-	1.7	-	
Brownout threshold hysteresis	--	-	70	-	mV

**Note:** For battery-powered equipment, the TX does not transmit at a wrong frequency under low battery voltage conditions. It remains on either channel or stops transmitting. The latter can of course be realized by using a lock detect and/or by switching off the PA under control of the battery monitor. For testing reasons this control is enabled/disabled by SPI.

## 5 Block description

### 5.1 Power management

The S2-LP integrates a high efficiency step-down converter cascaded with LDOs meant to supply both analog and digital parts. However, an LDO directly fed by the external battery provides a controlled voltage to the data interface block.

S2-LP's power management (PM) strategy, besides the basic functionality of providing different blocks with proper supplies, faces two main constraints: the first one is to implement such a power distribution with maximum efficiency, and the second one is to guarantee the isolation among critical blocks.

The efficiency target is obtained by using a switch mode power supply (SMPS) which converts the battery voltage (1.8 V - 3.6 V) to a lower voltage (settable from 1.2 V to 1.8 V) with efficiency higher than 90%.

The SMPS output voltage can be controlled by the SET\_SMPS\_LVL field in the PM\_CONF0 register. The relation between the SET\_SMPS\_LVL and the  $V_{OUT}$  of the SMPS is given by the following table:

**Table 35. SMPS output voltage**

SET_SMPS_LVL	SMPS output voltage
001b	1.2 V
010b	1.3 V
011b	1.4 V
100b	1.5 V
101b	1.6 V
110b	1.7 V
111b	1.8 V

The SMPS output voltage can be controlled in TX only or for both RX and TX according to the SMPS\_LVL\_MODE bit of the PM\_CONF1 register.

- 1: SMPS output level will depend upon the value in PM\_CONFIG register just in TX state, while in RX state it will be fixed to 1.4 V.
- 0: SMPS output level will depend upon the value written in the PM\_CONFIG0 register (SET\_SMPS\_LEVEL field) both in RX and TX state.

The SMPS switching frequency is settable by the 2 registers PM\_CONF3 and PM\_CONF2.

If the KRM\_EN is 0, then the digital divider by 4 enabled. In this case SMPS' switching frequency is:

$$F_{sw} = \frac{f_{dig}}{4} \quad (4)$$

If the KRM\_EN is 1, the SMPS' switching frequency can be set by the KRM word according to the formula:

$$F_{sw} = K_{rm} \frac{f_{dig}}{2^{15}} \quad (5)$$

As  $f_{dig}$  is the digital domain frequency ( $f_{XO}$  if it is 24, 25 or 26 MHz) and ( $\frac{f_{XO}}{2}$  if  $f_{XO}$  is 48, 50 or 52 MHz).

All the RX measurements reported in this datasheet have been taken with a SMPS frequency set to 1.56 MHz. From the formula reported with  $f_{dig} = 25$  MHz, PM\_CONF3 = 0x87, PM\_CONF2 = 0xFC, the  $F_{sw}$  is 1.56. It is possible to have a little improvement of the sensitivity reducing the SMPS switching frequency but having as drawback a higher current consumption.

The isolation target is reached by using, for each critical block, a dedicated linear low-dropout regulator (LDO), which provides typically 1.2 V output voltage, either from battery level or from SMPS level, depending from the operating mode.

If the output of the LDO is 1.2 V the minimum value of the SMPS,  $V_{out}$  must be at least 100 mV higher than the  $V_{out}$  of the LDO. This means that in HPM (SMPS+LDO) the minimum value of the SMPS\_VOUT must be 1.3 V. The S2-LP PM can be configured by SPI (BYPASS\_LDO field in PM\_CONFIG [1] register) in two main modes:

1. High performance mode (HPM)
2. Low power mode (LPM)

In HPM all available LDOs supplied from SMPS are used, to get the best possible isolation and minimum low-frequency noise level and SMPS ripple. SMPS must be set to 1.4 V at least.

In LPM the LDOs connected to the SMPS are by-passed and SMPS must be configured to provide 1.2 V output level to increase the regulation efficiency but with reduced isolation and higher low-frequency noise and SMPS ripple.

The load inductor of the SMPS has to have the following characteristics:

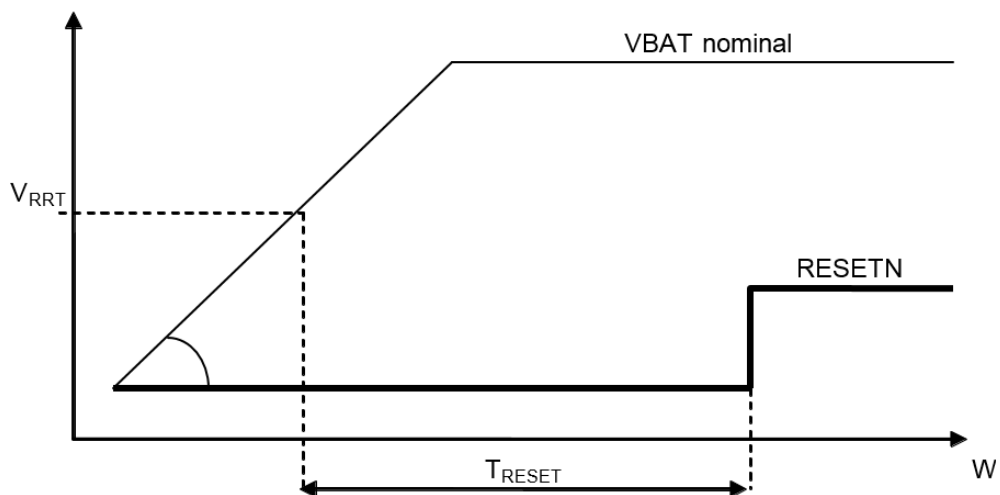
- A typical 10  $\mu$ H nominal value +/-10%
- A rated current of 100 mA minimum
- A DC resistance as low as possible (to guarantee maximum efficiency of the SMPS block), around 1 Ohm is a typically good value, but the lower the better

## 5.2 Power-On-Reset

The Power-On-Reset (POR) circuit generates a reset pulse upon power-up which is used to initialize the entire digital logic. Power-on-reset senses  $V_{BAT}$  voltage.

The S2-LP provides an automatic POR circuit, which generates an internal RESETN (active low) level for a time  $T_{RESET}$ , after the  $V_{BAT}$  reaches the reset release voltage threshold  $V_{RRT}$ , as shown in Figure 6. Power-On-Reset timing and limits. The same reset pulse is generated after a step-down on the input pin SDN ( $VDD > V_{RRT}$ ). This signal is available on the GPIO0 pin.

Figure 6. Power-On-Reset timing and limits



The parameters  $V_{RRT}$  and  $T_{RESET}$  are fixed by design in order to guarantee a reliable reset procedure of the state machine. In addition, all the registers are initialized to their default values.

A software command SRES is also available, it generates an internal but partial resetting of the S2-LP.

Table 36. POR parameters

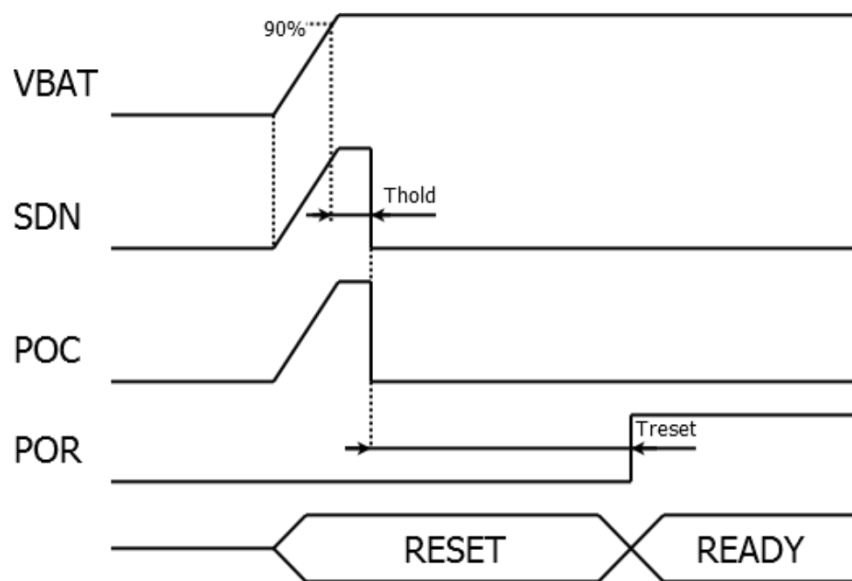
Parameter	Comment	Min.	Typ.	Max.	Unit
Reset start-up threshold voltage	-	-	0.5	-	V

Parameter	Comment	Min.	Typ.	Max.	Unit
Hold pulse width ( $T_{hold}$ , figure below)	For SDN to be effective	1	-	-	$\mu$ s
Reset pulse width ( $T_{reset}$ , figure below)	-	-	0.7	2	ms
Power-on VDD slope	-	-	2.0	-	V/ms

The following picture shows how the S2-LP must be controlled, i.e. the SDN signal must be tied to VBAT pin in order to avoid two potential issues during the start-up phase:

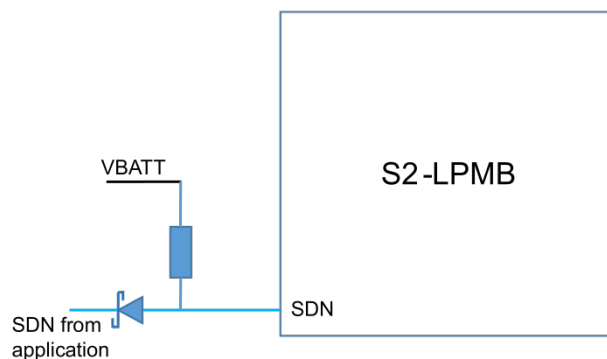
1. A cross conduction can appear on the GPIO until an available command is present on it.
  2. The ESD protection diode from the SDN pad can sink current from the external driver connected to the SDN.
- Also the SDN signal generates an internal signal (POC), which disables the digital I/Os when set to 1.

**Figure 7. Start-up phase**



Examples of possible connections

**Figure 8. Examples of possible connections for SDN pin**



### 5.3 RF synthesizer

A crystal connected to XIN and XOUT provides a clock signal to the frequency synthesizer. The allowed clock signal frequency is in the range [24-26] and [48-52] MHz.

As an alternative, an external clock signal feeds XIN for proper operation. In this option, XOUT can be left either floating or tied to ground.

Since the digital macro cannot be clocked at that double frequency (48, 50 or 52 MHz), a divided clock is used in this case (see Section 4.7: Crystal oscillator).

The integrated phase locked loop (PLL) is capable to synthesize a band of frequencies from 413 to 479 MHz, 452 to 527 MHz, 826 to 958 MHz or from 904 - 1055 MHz, providing the LO signal for the RX chain and the input signal for the PA in the TX chain.

Depending on the RF frequency and channel used, a very high accurate crystal or TCXO can be required.

The RF synthesizer implements fractional sigma delta architecture to allow fast settling and narrow channel spacing. It is fully integrated, and it uses a multi-band VCO to cover the whole frequency range. All internal calibrations are automatic.

According to the frequency synthesized the user must set the charge pump current according to the LO frequency variations, in order to have a constant loop bandwidth. The charge pump current is controlled by the PLL\_CP\_ISEL field (SYNT3 register) and the PLL\_PFD\_SPLIT\_EN (SYNTH\_CONFIG2). These fields should be set in the following way:

**Table 37. Charge pump words**

VCO Freq (MHz)	f <sub>xo</sub> (MHz)	PLL_CP_ISEL	PLL_PFD_SPLIT_EN	ICP (μA)
3760	50	010	0	120
3760	25	001	1	200
3460	50	011	0	140
3460	25	010	1	240

The S2-LP provides an automatic and very fast calibration procedure for the frequency synthesizer. If not disabled, it performs the calibration each time the synthesizer is required to lock to the programmed RF channel frequency (transition from READY to LOCK/TX/RX or from RX to TX and vice versa). After completion, the S2-LP uses the calibration word and is stored in registers.

In order to get the synthesizer locked with the calibration procedure disabled, the correct calibration words must be previously stored in registers by user for TX and RX respectively. The advantage is reduce the LOCK setting time.

The transition time enables the S2-LP for frequency hopping operation due to its reduced response time and very quick programming synthesizer.

### 5.3.1 RF channel frequency settings

The channel center frequency can be programmed as follows:

#### Center frequency setting

$$f_c = f_{base} + \left( \frac{f_{xo}}{2^{15}} \cdot CHSPACE \right) \cdot CHNUM \quad (6)$$

The  $f_{base}$  sets the main channel frequency; the value depends on the value of  $f_{xo}$  (the frequency of the XTAL oscillator, typically 24-26 MHz or 48-52 MHz).

#### Base frequency setting

$$f_{base} = \frac{f_{xo}}{\frac{B}{2} \cdot D} \cdot \frac{SYNT}{2^{20}} \quad (7)$$

where:

SYNT is a programmable 28-bits integer (SYNT[3:0] registers).

B is the out-of-loop SYNTH divider (BS field of the SYNT3 register):

#### PLL divider

$$B = \begin{cases} 4 & \text{for the high band (826 MHz to 1055 MHz, BS = 0)} \\ 8 & \text{for the middle band (413 MHz to 527 MHz, BS = 1)} \end{cases}$$

D is the reference divider (REFDIV bit of XO\_RCO\_CONFIG0 register)

(8)

**Reference divider**

$$D = \begin{cases} 1 & \text{if } REFDIV = 0 \text{ (internal reference divider is disabled)} \\ 2 & \text{if } REFDIV = 1 \text{ (internal reference divider is enabled)} \end{cases} \quad (9)$$

The resolution in the programmed value of the base frequency depends on the actual band selected.

**Table 38. Resolution frequency**

fxo [MHz]	High band resolution [Hz]	Low band resolution [Hz]
24	11.4	5.7
25	11.9	6.0
26	12.4	6.2
48	22.9	11.4
50	23.8	11.9
52	24.8	12.4

The  $f_c$  is the frequency related to the channel specified. RF channels can be defined using the CHSPACE and CHNUM registers. In this way, it is possible to change faster the channel by changing just an 8-bits register, allowing the setting of 256 channels and frequency-hopping sequences. The actual channel spacing is from 793 Hz to 202342 Hz in 793 Hz steps for the 26 MHz configuration and from 1587 to 404685 Hz in 1587 Hz steps for the 52 MHz configuration.

**Table 39. Channel spacing resolution**

fxo [MHz]	Channel spacing resolution [Hz]
24	732.42
25	762.94
26	793.45
48	1464.84
50	1525.88
52	1586.91

## 5.4 Digital modulator

The S2-LP supports frequency modulation: 2-FSK, 4-FSK, 2-GFSK, 4-GFSK as well amplitude modulation OOK and ASK. Using register, the user can also program an unmodulated carrier for lab test and measurement. A special mode, direct polar modulation, allows building specific modulation scheme controlling directly the amplitude and the frequency of the carrier synthesized. The register MOD\_TYPE is used to select one of the following modulation scheme.

**Table 40. Modulation scheme**

MOD_TYPE	Modulation scheme
000b	2-FSK
001b	4-FSK
010b	2-GFSK
011b	4-GFSK
101b	ASK/OOK
110b	Direct polar (TX only)
111b	CW

### 5.4.1 Frequency modulation

For frequency modulation 2-(G)FSK and 4-(G)FSK the frequency deviation can be tuned in wide range that depends on  $f_{xo}$  (XTAL frequency) according the following formula:

#### Frequency deviation

$$f_{dev} = \begin{cases} \frac{f_{xo}}{2^{19}} \cdot \frac{\text{round}(D \cdot FDEV\_M \cdot B/8)}{D \cdot B} & \text{if } FDEV\_E = 0 \\ \frac{f_{xo}}{2^{19}} \cdot \frac{\text{round}(D \cdot (256 + FDEV\_M) \cdot 2^{(FDEV\_E - 1)} \cdot B/8)}{D \cdot B} & \text{if } FDEV\_E > 0 \end{cases} \quad (10)$$

Where  $f_{xo}$  is the XTAL oscillation frequency, D is the reference divider and B is the band selector.

The frequency deviation programmed corresponds to the deviation of the outer constellation symbols. The deviation of the inner symbols is 1/3 of such programmed values, as reported in the table below, where 4 options are available.

Furthermore, since the payload is normally arranged in bytes, the arrangement can change the mapping for both 2-(G)FSK and 4-(G)FSK modulations, by using the CONST\_MAP (register MOD1), in the following way:

**Table 41. Constellation mapping 2-(G)FSK**

Format	Symbol	CONST_MAP coding			
		0	1	2	3
2-(G)FSK	0	-FDEV	NA	+FDEV	NA
	1	+FDEV	NA	-FDEV	NA

**Table 42. Constellation mapping 4-(G)FSK**

Format	Symbol	CONST_MAP coding			
		0	1	2	3
4-(G)FSK	00	-FDEV/3	-FDEV	+FDEV/3	+FDEV
	01	-FDEV	-FDEV/3	+FDEV	+FDEV/3
	10	+FDEV/3	+FDEV	-FDEV/3	-FDEV
	11	+FDEV	+FDEV/3	-FDEV	-FDEV/3

Furthermore, in the 4-(G)FSK it is also possible to swap the symbols using the 4FSK\_SYM\_SWAP field (register PKTCTRL3) as follows:

$$\text{When } 4FSK\_SYM\_SWAP = 0: \begin{cases} S0 = \langle b7b6 \rangle \\ S1 = \langle b5b4 \rangle \\ S2 = \langle b3b2 \rangle \\ S3 = \langle b1b0 \rangle \end{cases} \quad (11)$$

$$\text{When } 4FSK\_SYM\_SWAP = 1: \begin{cases} S0 = \langle b6b7 \rangle \\ S1 = \langle b4b5 \rangle \\ S2 = \langle b2b3 \rangle \\ S3 = \langle b0b1 \rangle \end{cases}$$

#### 5.4.1.1 Gaussian shaping

In 2-GFSK or 4-GFSK mode, the Gaussian filter BT product can be set by using the register BT\_SEL to 1 or 0.5.

The Gaussian filtering is implemented by poly-phase filtering with eight taps per symbol time. In order to further smooth the filter shape and improve spectral shaping, the output of the filter can be linearly interpolated by setting the register MOD\_INTERP\_EN.

A mathematical interpolation factor is applied at each sample of the Gaussian filter output. This factor is 64 for data rates corresponding to  $DATA\_RATE\_E < 5$ , it is automatically scaled as  $\frac{64}{2^{DATA\_RATE\_E-5}}$  for  $5 \leq DATA\_RATE\_E < 11$  and it is automatically disabled for  $DATA\_RATE\_E = 11$ .

*Note:* The actual interpolation factor achieved may be limited by the minimal frequency resolution of the frequency synthesizer.

#### 5.4.1.2 ISI cancellation 4-(G)FSK

Since the 4-(G)FSK modulation format strongly suffers from the effect of inter symbol interference, an ISI cancellation equalizer has been introduced in the demodulator. An equalizer can be enabled, by using the EQU\_CTRL register, with two modes: single pass equalization and dual pass equalization. The best performance is normally achieved using the dual pass equalizer.

#### 5.4.2 Amplitude modulation

Amplitude modulation OOK and ASK are both supported by the S2-LP. The ASK selection depends on power ramping enable.

When OOK is selected, a bit '1' is transmitted with a programmed power, set by register PA\_POWER[PA\_LEVEL\_MAX\_INDEX], and a bit '0' is transmitted without output power (PA off) and specified by the register PA\_POWER[0].

In case PA\_POWER[0] = 0 then the modulation will be OOK, otherwise when PA\_POWER[0] is not set to zero the modulation will be ASK. The 0/1 mapping can be reversed by setting the CONST\_MAP register to any value other than zero.

When ASK is selected, a bit '1' is transmitted with a power ramp increasing from the minimum value specified by register PA\_POWER[0] to specified PA maximum level in register PA\_POWER[PA\_LEVEL\_MAX\_INDEX], vice versa for a bit '0'. The duration of each power step is a multiple of 1/8 of the symbol time, configurable with the register PA\_RAMP\_STEP\_WIDTH. If more '1's are transmitted consecutively, the PA power maintains the output power at the programmed value. If more '0's are transmitted consecutively, the PA power remains at minimum power for all '0's following the first one.

In order to improve the spectral emission mask is ASK a digital interpolation optional features have been implemented. When this feature is enabled, through the register PA\_INTERP\_EN, the modulator linearly interpolates the power values specified in the PA\_POWER registers before being applied to the PA.

The interpolation factor of each ramp step is 64 time the data rate corresponding to  $DATA\_RATE\_E < 5$  it is automatically scaled as  $64/2^{(DATA\_RATE\_E-5)}$  for  $5 \leq DATA\_RATE\_E < 11$  and it is automatically disabled for  $DATA\_RATE\_E=11$ .

Note that the number of clock cycles between successive PA ticks, for  $DATA\_RATE\_E \geq 5$ , is always between 8 and 4 (8 for  $DATA\_RATE\_M=0$ ; 4 for  $DATA\_RATE\_M=65535$ ).

OOK/ASK demodulation is controlled by the OOK\_PEAK\_DECAY parameter (recommended value is 3) in the RSSI\_FLT register.

##### 5.4.2.1 OOK smoothing

The OOK can be smoothed using a FIR filter added in the data path. This feature is activated by setting the FIR\_EN bit at 1 inside register PA\_CONFIG1.

The FIR filter is not fully customizable but it can be set in 3 different configurations that change the spectrum shape (and thus the bandwidth):

- **filter:** it is the proper FIR filtering function of the stream of bits 8 times oversampled;
- **ramp:** the FIR filter is optimized to perform a ramping between PA\_POWER\_MAX and PA\_POWER\_0 (for OOK should be set to 0).
- **switch:** logic 1s and 0s are associated with a single value of power and no transition between the 2 is envisaged.

When the FIR\_EN bit is 1, the DIG\_SMOOTH\_EN (PA\_POWER\_0 register) must be set to 1.

Finally, a 2<sup>nd</sup> order Bessel analog filter can be used to smooth the output signal. The bandwidth of this filter should be set according to the data rate used by setting the PA\_FC field of the register PA\_CONFIG0 according to the following table:

**Table 43. PA Bessel filter words**

PA_FC bits	Cut-off frequency (kHz)	Max. data rate (kbit/s)
00	12.5	16
01	25	32
10	50	62.5
11	100	125

**Note:** The FIR ramping modes are used in a mutually exclusive way with the digital ramping. When the digital ramping is used, the FIR ramping should be disabled. Vice versa, if the FIR ramping is used, the digital one is not used.

### 5.4.3 Direct polar mode

The S2-LP allows the user to drive the SYNTH and the PA at a very low level. The byte couples written in the TX\_FIFO are sampled with a rate related to the DATARATE chip setting (sampling rate = 8\*DATARATE). The first byte of the couple drives the frequency synthesizer to obtain an instantaneous output frequency deviation given by the formula below:

#### Frequency deviation in polar mode

$$fdev = fdev\_programmed * \frac{fdev\_fifo\_sample}{128} \tag{12}$$

Where  $fdev\_programmed$  is the frequency deviation programmed in the chip by the registers MOD[1:0] (see Section 5.4.1: Frequency modulation),  $fdev\_fifo\_sample$  is the first byte of the bytes couple sampled from the TX\_FIFO.

The  $fdev\_fifo\_sample$  is interpreted as a 2-complement 8-bit number, thus it can be either a positive or a negative value.

The instantaneous frequency is given by the formula:

#### Instantaneous frequency in polar mode

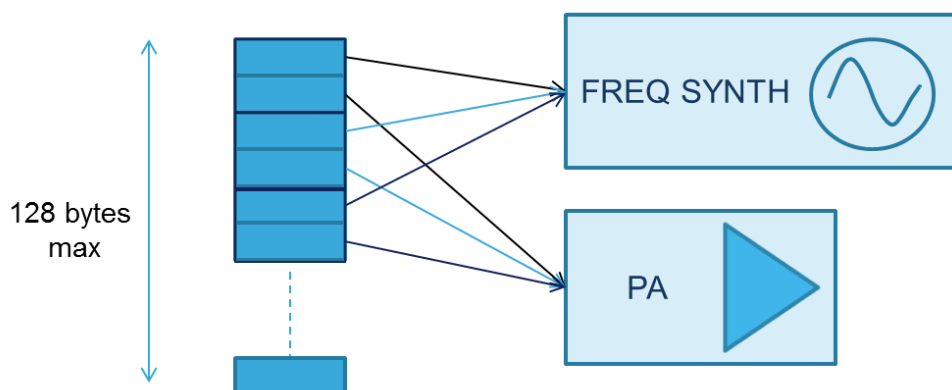
$$f = fc\_programmed + fdev \tag{13}$$

The second byte of the TX\_FIFO couple drives the PA giving an instantaneous output power.

The output power will be generated according to this value following the same code as the PA\_POWER registers (see Section 5.6.1: PA configuration).

Figure 9. Direct polar mode shows how the byte couples are sampled from the TX FIFO and sent to the SYNTH and PA blocks.

**Figure 9. Direct polar mode**



As for the normal TX operations, the TX\_FIFO samples are consumed and a management of the TX\_FIFO\_THRESHOLD is needed to perform transmissions longer than 128 samples.

The transmission is never automatically stopped and a specific command SABORT should be given to terminate it.

This function is suitable to implement differential binary phase shift keying modulation (DBPSK) such as the data modulation used by the SigFox protocol.

## 5.4.4 Test modes

### 5.4.4.1 Continuous wave

The device can be programmed to generate a continuous wave carrier without any modulation. In this way, the carrier will be continuously transmitted until a SABORT command is sent to the device.

To set the continuous wave the MOD\_TYPE field (of the MOD2 register) must be set to 0x77.

### 5.4.4.2 PN9

It is possible to set a pseudo random binary sequence 9 (PN9) as data source for the modulator. In this way, these data are continuously modulated until a SABORT command is sent to the device.

The TXSOURCE field (of the PCKTCTRL1 register) must be set to 0x03.

## 5.4.5 Data rate

The data rate programmable is from 0.1 kbps to 500 kbps (see Table 12. General characteristics for further details).

The data rate formula that relates the value of the DATARATE\_M and DATARATE\_E registers to the data rate in symbol per second is the following:

### Data rate formula

$$DataRate = \begin{cases} f_{dig} \cdot \frac{DATARATE\_M}{2^{32}} & \text{if } DATARATE\_E = 0 \\ f_{dig} \cdot \frac{(2^{16} + DATARATE\_M) \cdot 2^{DATARATE\_E}}{2^{33}} & \text{if } DATARATE\_E > 0 \\ \frac{f_{dig}}{8 \cdot DATARATE\_M} & \text{if } DATARATE\_E = 15 \end{cases} \quad (14)$$

where  $f_{dig}$  is the digital clock frequency.

In the cases where  $DATARATE\_E < 15$ , the actual modulator timing is generated by a fractional clock divider hence is affected by a certain amount of jitter. In order to have a jitter free data rate generation a specific mode the last equation must be used,  $DATARATE\_E = 15$  (for transmission only).

## 5.5 Receiver

The S2-LP contains a low-power low-IF receiver able to amplify the input signal and provide it to the ADC with a proper signal to noise ratio. The RF antenna signal is converted to a differential one by an external balun, which performs an impedance transformation also. The receiver gain can be programmed to accommodate the ADC input signal within its dynamic range. After the down-conversion at IF, a first order filter is implemented to attenuate the out-of-band blockers.

### 5.5.1 Automatic frequency compensation

The automatic frequency compensation (AFC for short) algorithm allows compensating, within certain limits, a relative frequency error between the transmitting device and the receiving one caused by for example from crystal inaccuracies.

The AFC algorithm is operational only for frequency modulation such as 2-(G)FSK and 4-(G)FSK.

Due to the demodulation algorithm employed, any frequency error results in a DC offset in the demodulated signal before slicing.

The basic operating principle of the AFC is that the minimum and maximum signal frequencies are detected and a correction is calculated to remove the aforementioned offset.

Such correction is either applied at the slicer level in the form of offset compensation (default mode) or, optionally, is used to adjust the second IF conversion stage frequency. The former mode allows a quick recovery of the frequency error but does not prevent part of the received signal power to be cut by the channel filter; the latter mode adjusts the signal frequency before entering the channel filter thus avoiding power loss but requires a longer period to settle. The first mode is recommended for normal operation.

The AFC also provides the estimated frequency error through the AFC\_CORR register. If the frequency error is known to be constant (for example communication always occurs between the same pair of devices), this value can directly be used to correct the programmed center frequency.

AFC\_CORR register:

$F_{dig}/(3 \cdot 2^{13})$  where  $F_{dig}$  is the frequency of the digital block (24, 25 or 26 MHz).

1 LSB is:

At 24 MHz: 976.5625 Hz

At 25 MHz: 1017.25260416 Hz

At 26 MHz: 1057.9427083 Hz

In order to guarantee both fast lock and smooth tracking, the AFC has a fast mode and a slow mode. The AFC starts in fast mode as soon as the RSSI threshold is passed and will switch to the slow mode after a programmable period.

The AFC is controlled by the following parameters:

- RSSI threshold: this parameter sets the minimum signal power above which the AFC algorithm is started (RSSI\_TH register).
- AFC fast gain log2: this parameter sets the loop gain in the fast mode (AFC0 register), the range allowed is 0..15.
- AFC slow gain log2: this parameter sets the loop gain in the slow mode (AFC0 register), the range allowed is 0..15.
- AFC fast period: this parameter sets the length of the fast period in number of samples (AFC1 register), the range allowed is 0..255. The recommended setting for this parameter is such that the fast period equals the preamble length. Since the algorithm operates typically on 2 samples per symbol, the programmed value should be twice the number of preamble symbols. If this parameter is set to 0 then the switching from fast to slow mode is controlled by the sync word detection, for example the fast gain is used before the sync detection, the slow gain is used after sync detection.
- AFC mode: this parameter sets the AFC correction mode (AFC2 register. 0b: slicer correction, 1b: 2nd IF correction).
- AFC enable: this parameter enables the AFC algorithm (AFC2 register).

### 5.5.2 Automatic gain control

The automatic gain control (AGC for short) algorithm is designed to keep the signal amplitude at the input of the IF ADC within a specific range by controlling the gain of the RF chain in 6 dB steps, up to a maximum attenuation of 48 dB, starting at a received signal power of about -50 dBm.

From an implementation point of view, the (peak) signal amplitude is measured in the digital domain after the primary decimation filters chain and compared to a low threshold and to a high threshold. If the amplitude is above the high threshold, the attenuation is increased sequentially until the amplitude goes below the threshold; if the amplitude is below the low threshold, the attenuation is decreased sequentially until the amplitude goes above the threshold.

The AGC algorithm is controlled by the following parameters:

**High threshold:** this value sets the digital signal level above which the RF attenuation is increased (AGCCTRL1 register, allowed values 0..15). The recommended setting for such parameter is 0x5.

**Low thresholds:** this allows a better tuning of the low thresholds in case the analog attenuation steps have a significant spread around the nominal 6 dB attenuation. The threshold actually used for each step is selected through the bits of the LOW\_THRESHOLD\_SEL (AGCCTRL3) register. The recommended setting for Low Threshold 0 is 0x5, recommended setting for Low Threshold 1 is 0x4. The recommended value for LOW\_THRESHOLD\_SEL is 0x10.

**Measure time:** this parameter sets the measurement interval during which the signal level is monitored before the AGC attenuation is decreased. In particular, if the signal level is below the low threshold for all the duration of such period, then the attenuation is decreased.

The actual time is  $T_{AGC\ meas} = \frac{12}{f_{dig}} \cdot 2^{MEAS\_TIME}$ , ranging from about 0.5  $\mu$ s to about 15 ms.

For frequency modulation, the measurement time is normally set to a few  $\mu$ s in order to achieve fast settling of the algorithm.

For amplitude, to avoid an unstable behavior, the measure time must be larger than the duration of the longest train of '0' symbols expected during the preamble/synchronization word.

The default value for such parameter is 0x2.

**Hold time:** this parameter sets a wait time for the algorithm to let the signal level to settle after a change in the attenuation level.

The actual time is  $T_{AGC\ hold} = \frac{12}{f_{dig}} \cdot HOLD\_TIME$ , ranging from about 0.5  $\mu$ s to about 32  $\mu$ s.

The recommended setting for such parameter is 0x0C.

**AGC enable:** enables the AGC algorithm.

**Freeze on sync:** freeze the AGC level after when the sync word has been received.

The AGC algorithm works in the following way:

- If the amplitude is above the **high threshold**, the attenuation is increased sequentially until the amplitude goes below the threshold. In this case the  $T_{meas}$  is set to 0 and only the hold time is used. Thus, if the signal is above the high threshold, the AGC word is changed each  $T_{hold}$  seconds.
- If the amplitude is below the **low threshold**, the attenuation is decreased sequentially until the amplitude goes above the threshold. In this case the  $T_{meas}$  is set to the value:  $T_{hold} = (12 \cdot 2MEAS\_TIME) / f_{dig}$ . Thus, if the signal is below the low threshold, the AGC word is changed each  $T_{meas} + T_{hold}$  seconds.

The two operations are repeated in a loop until the input signal strength is between the high and the low threshold.

### 5.5.3 Symbol timing recovery

The S2-LP supports two different algorithms for the timing recovery. The selection of the algorithm is done with the register CLOCK\_REC\_ALGO\_SEL.

- If CLOCK\_REC\_ALGO\_SEL = 0, then a simple first order algorithm is used (shortly referred to as DLL).
- If CLOCK\_REC\_ALGO\_SEL = 1, then a second order algorithm is used (shortly referred to as PLL).

Besides the configuration parameters mentioned above, the setting of the following registers also affects the behavior of the clock recovery algorithms.

- Post-filter length: this parameter controls the length of the demodulator post-filter (CLOCKREC register). Setting this value to 1B may improve demodulation performance but requires a slower recovery. The recommended value for such parameter is 0B.
- RSSI threshold: this parameter sets the minimum signal power above which the timing recovery is started (RSSI\_TH register).

#### 5.5.3.1 DLL mode

The DLL algorithm, being based on a first order loop, is only able to control the delay of the local bit-timing generator in order to align it to the received bit period. If there is an error between the actual received bit period and the nominal one, the relative edges will drift over time and the algorithm will periodically apply a delay correction to recover. Since in presence of long sequences of zeroes or ones it is not possible to estimate any timing error, the loop tends to lose lock if the period error is large (greater than 3%).

The convergence speed of the loop is controlled by the CLK\_REC\_P\_GAIN\_FAST/SLOW parameter (KP) in the CLOCKREC1 and CLOCKREC2 registers with a smaller value yielding a faster loop. Allowed values for KP are from 0 to 7. The optimal values obtained for all modulations and data rates are KP = 1 or KP = 2.

#### 5.5.3.2 PLL mode

The PLL algorithm tracks the phase error of the local timing generator relative to received bit period and controls both frequency and phase to achieve the timing lock. Once that the relative period error has been estimated and corrected for example during the preamble phase, then even in presence of long sequences of zeroes or ones, the loop is able to keep lock.

In order to improve the performance of the algorithm, two sets of gain coefficients can be configured to be used before and after the sync word detection.

In particular, CLK\_REC\_I\_GAIN\_FAST and CLK\_REC\_P\_GAIN\_FAST are used before the SYNC while CLK\_REC\_I\_GAIN\_SLOW and CLK\_REC\_P\_GAIN\_SLOW are used after the SYNC detection.

### 5.5.4 RX channel filter bandwidth

The bandwidth of the receiver channel filter is programmable from 1 kHz to 800 kHz. The setting goes through the register CHFLT according to the following table.

**Table 44. Channel filter words**

	E=0	E=1	E=2	E=3	E=4	E=5	E=6	E=7	E=8	E=9
M=0	800.1	450.9	224.7	112.3	56.1	28.0	14.0	7.0	3.5	1.8
M=1	795.1	425.9	212.4	106.2	53.0	26.5	13.3	6.6	3.3	1.7
M=2	768.4	403.2	201.1	100.5	50.2	25.1	12.6	6.3	3.1	1.6
M=3	736.8	380.8	190.0	95.0	47.4	23.7	11.9	5.9	3.0	1.5
M=4	705.1	362.1	180.7	90.3	45.1	22.6	11.3	5.6	2.8	1.4
M=5	670.9	341.7	170.6	85.3	42.6	21.3	10.6	5.3	2.7	1.3
M=6	642.3	325.4	162.4	81.2	40.6	20.3	10.1	5.1	2.5	1.3
M=7	586.7	294.5	147.1	73.5	36.7	18.4	9.2	4.6	2.3	1.2
M=8	541.4	270.3	135.0	67.5	33.7	16.9	8.4	4.2	2.1	1.1

The actual filter bandwidth for any digital clock frequency can be obtained by multiplying the values in the table above by the factor  $\frac{f_{dig}}{26000000}$ . The bandwidth values are intended as double-sided.

### 5.5.5 Intermediate frequency setting

The intermediate frequency (IF) can be tuned and be controlled by the registers IF\_OFFSET\_ANA and IF\_OFFSET\_DIG and can be set as follows:

**Intermediate frequency**

$$f_{IF} = \frac{f_{xo}}{12} \cdot \frac{(IF\_OFFSET\_ANA + 100)}{2^{11}} = \frac{f_{dig}}{12} \cdot \frac{(IF\_OFFSET\_DIG + 100)}{2^{11}} \quad (15)$$

where  $f_{xo}$  is the XTAL oscillator frequency and  $f_{dig}$  is the digital clock frequency. The recommended IF value is about 300 kHz.

### 5.5.6 RX timer management

The programmable RX timer used can be configured using quality indicator to avoid unwanted interruption during a valid packet due to RX timer expiration. The quality indicators used to stop the RX timer are SQI, CS and PQI. More specifically, AND or OR Boolean relationships among any of them can be configured, to suit user application. In particular, it is required to include always SQI valid check, to avoid to stay in RX state for unlimited time, if timeout is stopped but no valid SQI is detected (in such cases, the RX state can be left using a SABORT command).

On timer expiration, reception aborts and the packet is discarded.

**Table 45. RX timer stop condition configuration**

RX_TIMEOUT_AND_OR_SELECT	CS_TIMEOUT_MASK	SQI_TIMEOUT_MASK	PQI_TIMEOUT_MASK	Description
0	0	0	0	The RX timeout never expires and the reception ends at the reception of the packet
1	0	0	0	The RX timeout cannot be stopped. It starts at the RX state and at the end expires
X	1	0	0	RSSI above threshold
X	0	1	0	SQI above threshold (default)
X	0	0	1	PQI above threshold
0	1	1	0	Both RSSI AND SQI above threshold
0	1	0	1	Both RSSI AND PQI above threshold
0	0	1	1	Both SQI AND PQI above threshold

RX_TIMEOUT_AND_OR_SELECT	CS_TIMEOUT_MASK	SQI_TIMEOUT_MASK	PQI_TIMEOUT_MASK	Description
0	1	1	1	ALL above threshold
1	1	1	0	RSSI OR SQI above threshold
1	1	0	1	RSSI OR PQI above threshold
1	0	1	1	SQI OR PQI above threshold
1	1	1	1	ANY above threshold

### 5.5.7 Receiver data modes

Direct modes are primarily intended to completely bypass the automatic packet handler, in order to give the user maximum flexibility in the choice of frame formats. Specifically:

- **Direct through FIFO mode:** the packet bytes are continuously received and written in the RX FIFO without any processing. It is the responsibility of the microcontroller to avoid any overflow conditions on the RX FIFO.
- **Direct through GPIO mode:** the packet bits are continuously written to one of the GPIO pins without any processing. To allow the synchronization of an external data sink, a data clock signal is also provided on one of the GPIO pins. Data are updated by the device on the falling edge of such clock signal so the MCU must read it during falling edge of CLK.

### 5.5.8 Receiver quality indicators

#### 5.5.8.1 RSSI

The measured RSSI is in steps of 1 dB, from 0 to 255 (1 byte value) and it is offset in such a way that the number 0 corresponds to -146 dBm, so the register value can be converted in dBm by subtracting 146. Laboratory calibration may be needed for accurate absolute power measurements. The RSSI value can be read through two registers: RSSI\_LEVEL\_CAPTURE and RSSI\_LEVEL\_RUN. In particular RSSI\_LEVEL\_CAPTURE reports the RSSI value captured at the end of the SYNC word detection, exit from RX state by SABORT command or RX timeout expiration, while RSSI\_LEVEL\_RUN is the continuous output of the RSSI filter. The last mode supports the continuous fast SPI reading that means if the CSn signal, of the SPI interface, is kept low, after the first 16 bits (S2-LP status register), then a new RSSI value will be available every 8 SPI clock cycles (this mode is the same of the SPI burst mode, but no automatic address increment).

#### 5.5.8.2 Carrier sense

The carrier sense functionality can be used to detect if any RF signal is being received, the detection is based on the measured RSSI value. There are two operational modes for carrier sensing: static and dynamic carrier sensing.

When static carrier sensing is used (CS\_MODE = 0), the carrier sense signal is asserted when the measured RSSI is above the value specified in the RSSI\_TH register and is de-asserted when the RSSI falls 3 dB below the same threshold.

When dynamic carrier sense is used (CS\_MODE = 1, 2, 3), the carrier sense signal is asserted if the signal is above the threshold and a fast power increase of 6, 12 or 18 dB is detected; it is de-asserted if a power fall of the same amplitude is detected.

The carrier sense signal is also used internally to the demodulator to start the automatic frequency compensation and timing recovery algorithms and for the CSMA procedure (for this usage in should be set CS\_MODE = 0).

The carrier sense function is controlled by the following parameters:

- RSSI threshold: this parameter sets the minimum signal power above which the carrier sense signal is asserted (RSSI\_TH register).
- CS mode: this parameter controls the carrier sense operational modes.

**Table 46. CS mode description**

CS_MODE	Description
0	Static carrier sensing
1	Dynamic carrier sensing with 6 dB dynamic threshold

CS_MODE	Description
2	Dynamic carrier sensing with 12 dB dynamic threshold
3	Dynamic carrier sensing with 18 dB dynamic threshold

### 5.5.8.3 PQI

The preamble quality indicator (PQI) is intended to provide a measurement of the reliability of the preamble detected. The PQI is increased by 1 every time a bit inversion occurs, while it is decreased by 4 every time a bit repetition occurs. The running peak PQI is compared to a threshold value and the preamble valid IRQ is asserted as soon as the threshold is passed. The preamble quality indicator threshold is  $4 \times \text{PQI\_TH}$  (with  $\text{PQI\_TH} = 0, 1, \dots, 15$ ).

### 5.5.8.4 SQI

The synchronization quality indicator (SQI) is a measurement of the best correlation between the received SYNC word and the expected one. This indicator is calculated as the peak cross-correlation between the received data stream and the expected SYNC word. If the  $\text{SQI\_EN} = 1\text{b}$ , the running peak SQI is compared to a threshold value and the SYNC valid IRQ is asserted as soon as the threshold is passed. The SYNC quality threshold is equal to  $\text{SYNC\_LEN} - 2 \times \text{SQI\_TH}$  (with  $\text{SQI\_TH} = 0, 1, \dots, 7$ ). When  $\text{SQI\_TH} = 0\text{b}$ , perfect match is required. It is recommended the SQI check always enabled. The peak SQI value can be read from the register  $\text{SQI}[5:0]$  and represents the peak value from 0 to 32, while the bit  $\text{SQI}[6]$ , when equal to '1' indicates that the SQI peak value refers to the secondary SYNC word.

### 5.5.9 CS blanking

The CS blanking feature prevents any reception starting if the RSSI level on the air is below the RSSI threshold (set by the  $\text{RSSI\_TH}$  field). The feature can be enabled through the  $\text{CS\_BLANKING}$  bit in the  $\text{ANT\_SELECT\_CONF}$  register.

Therefore, to start the sync word search, the signal level must be higher than the RSSI threshold.

### 5.5.10 Antenna switching

The device implements a switching based antenna diversity algorithm. The antenna switching function allows controlling an external switch in order to select the antenna providing the highest measured RSSI. The switching decision is based on a comparison between the received power level on antenna 1 and antenna 2 during the preamble reception controlling through GPIO an external RF switch in order to select the antenna providing the highest measured RSSI.

When antenna switching is enabled, the two antennas are repeatedly switched during the reception of the preamble of each packet, until the carrier sense threshold is reached (static CS mode must be used). From this point on, the antenna with highest power is selected and switching is frozen. The switch control signal is available on GPIO and in the  $\text{MC\_STATE}[1]$  register.

The algorithm is controlled by the following parameters:

- $\text{AS\_MEAS\_TIME}$ : this register/parameter controls the time interval for RSSI measurement. The actual measurement time is done with the following formula.

#### Antenna switching measurement time

$$T_{meas} = 2^{(1 + \text{AS\_MEAS\_TIME})} \times \frac{24 \times 2^{\text{CHFLT\_E}}}{f_{dig}} \quad (16)$$

In case of FSK modulation, the whole  $T_{meas}$  is used to let the signal level settle after the antenna switch and one single measurement is taken at the end of such period.

In case of OOK modulation, after one first interval equal to  $T_{meas}$  again used to let the signal level settle after the antenna switch, one second interval still equal to  $T_{meas}$ , is used to perform a peak power measurement and select the best antenna.

- $\text{AS\_ENABLE}$ : this parameter enables the antenna switching function.

## 5.6 Transmitter

The S2-LP contains an integrated PA capable of transmitting at output levels programmable between -30 dBm to +14 dBm (+16 dBm in boost mode), at step of 0.5 dB.

The PA is single-ended and has a dedicated pin (TXOUT). The PA output is ramped up and down to prevent unwanted spectral splatter. In TX mode the PA drives the signal generated by the frequency synthesizer out to the antenna terminal. Delivered power, as well as harmonic content, depends on the external impedance seen by the PA. It is possible to program TX to send an unmodulated carrier.

The output stage is supplied from the SMPS through an external choke and is loaded with a LC-type network which has the function of transforming the impedance of the antenna and filter out the harmonics. The TX and RX pins are tied directly to share the antenna. During TX, the LNA inputs are internally shorted to ground to allow for the external network resonance, so minimizing the power loss due to the RX.

### 5.6.1 PA configuration

The PA output power level is programmable in 0.5 dB steps. The user can store up to eight output levels to provide flexible PA power ramp-up and ramp-down at the start and end of a frequency modulation transmission as well as ASK modulation shaping.

With the digital power-ramping enabled (`PA_RAMP_EN = 1` in the `PA_POWER0` register) the ramp starts from the minimum output power programmed and stops at the programmed maximum value, thus a maximum of 8 steps can be set up as shown in [Figure 10. Output power ramping configuration](#). The interpolation factor ranges from 64 down to 1 depending on the actual data rate. The assumption is that output power monotonically decrease. Each step is held for a programmable time interval expressed in terms of bit period units ( $T_b/8$ ), maximum value is 3 (which means  $4 \times T_b/8 = T_b/2$ ). Therefore, the PA ramp may last up to 4  $T_b$  (about 3.3 ms if the bit rate is 1.2 kbit/s).

$$T_{ramp} = \frac{(PA\_RAMP\_STEP\_LEN + 1) \times (PA\_LEVEL\_MAX\_IDX + 1)}{8 \times DataRate} \quad (17)$$

where *DataRate* is the transmission data rate expressed in symbols/s.

The set of eight levels is used to shape the ASK signal. In this case, the modulator works as a counter that counts when transmitting a one and down when transmitting a zero. The counter counts at a rate equal to 8 times the symbol rate (in this case, the step width is fixed by symbol rate).

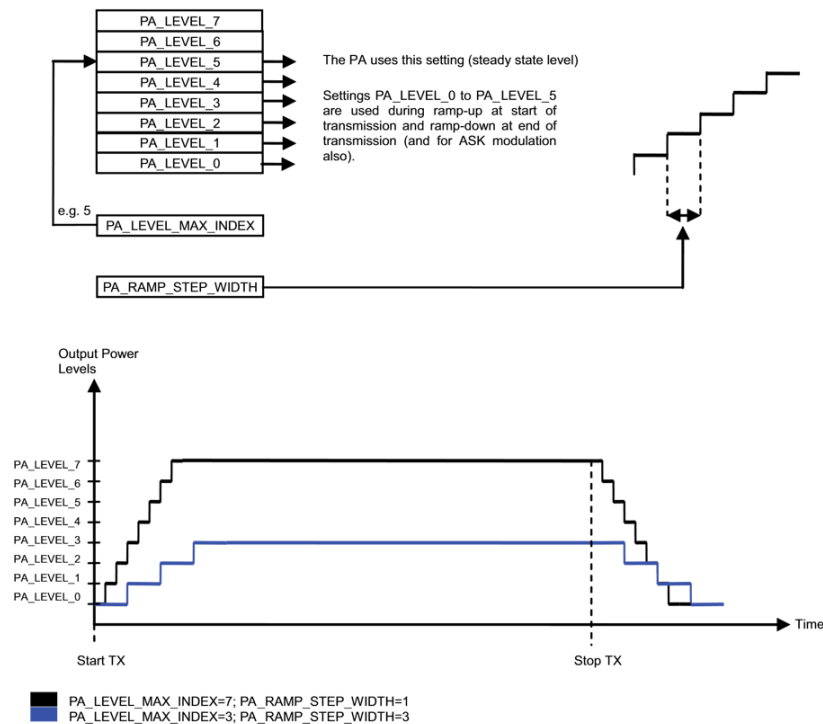
For OOK modulation, the signal is abruptly switched between two levels only: no power and maximum. This mode is obtained setting the `PA_RAMP_EN=0`.

With the digital power-ramping, the digital PA interpolation can be enabled through the `PA_INTERP_EN` field of the `MOD1` register.

When this feature is enabled, the power values specified in the `PA_POWER` registers are linearly interpolated by the modulator before being applied to the PA.

The mathematical interpolation factor applied at each output sample is 64 for data rates corresponding to `DATA_RATE_E < 5`, it is then automatically scaled as  $\frac{64}{2^{DATA\_RATE\_E - 5}}$  and it is automatically disabled for `DATA_RATE_E = 11`.

Figure 10. Output power ramping configuration



### 5.6.2 Transmitter data modes

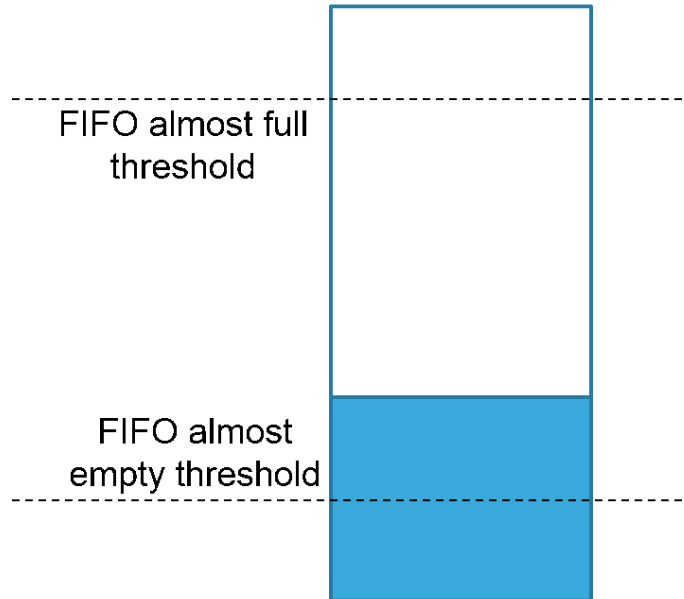
Direct modes are primarily intended to completely bypass the automatic packet handler, in order to give the user maximum flexibility in the choice of frame formats. In specific:

- **Direct through FIFO mode:** the packet is written in TX FIFO. The user build the packet according to his need including preamble, payload and soon on. The data are transmitted without any processing.
- **Direct through GPIO mode:** the packet bits are continuously read from one of the GPIO pins, properly configured, and transmitted without any processing. To allow the synchronization of an external data source, a data clock signal is also provided on one of the GPIO pins. Data are sampled by the device on the rising edge of such clock signal; it is the responsibility of the external data source to provide a stable input at this edge.
- **PN9 mode:** a pseudo-random binary sequence is generated internally. This mode is provided for test purposes only.

### 5.6.3 Data FIFO

In the S2-LP there are two data FIFOs, a TX FIFO for data to be transmitted and an RX FIFO for the received data both of 128 bytes. The SPI interface is used to read from the RX FIFO and write to the TX FIFO starting from the address 0xFF.

Figure 11. Threshold in FIFO



The TX FIFO has two programmable thresholds (see figure above). An interrupt event occurs when the data in the TX FIFO reaches any of these thresholds. The first threshold is the “FIFO Almost Full” threshold, TX\_AF\_THR registers. The value in this field corresponds to the desired threshold value in number of bytes + 2. When empty locations (free) amount inside the TX FIFO reaches this threshold limit, an interrupt to the MCU is generated so it can send a TX command to transmit the contents of the TX FIFO. The second threshold for TX is the “FIFO Almost Empty” threshold, TX\_AE\_THR register. When the data being shifted out of the TX FIFO reaches the Almost Empty threshold, an interrupt will be generated also. The MCU could to switch out of TX mode or fill new data into the TX FIFO.

The RX FIFO has two programmable thresholds (see figure above). The first threshold is the “FIFO Almost Full” threshold, RX\_AF\_THR0 registers. The value in this register corresponds to the desired threshold value in number of bytes. When empty locations (free) amount inside the RX FIFO reaches this threshold limit, an interrupt will be generated to the MCU. The MCU should then start to read the data from the RX FIFO. The second threshold for RX is the “FIFO Almost Empty” threshold, RX\_AE\_THR register. When the data being shifted out of the RX FIFO reaches the Almost Empty threshold, an interrupt will be generated also. The MCU will need to switch on RX mode to fill with new data the RX FIFO or stop to read after the number of byte indicated by the RX\_AE\_THR register.

In order to enable the RX\_FIFO thresholds interrupts, the bit FIFO\_GPIO\_OUT\_MUX\_SEL (PROTOCOL2 register) must be set to 1. To enable the TX\_FIFO thresholds interrupts the FIFO\_GPIO\_OUT\_MUX\_SEL must be set to 0.

The FIFO controller detects overflow or underflow in the RX FIFO and overflow or underflow in the TX FIFO. It is the responsibility of the MCU to avoid TX FIFO overflow since the MCU only can decide to writing on the TX FIFO. A TX FIFO overflow results in an error in the TX FIFO content, while an underflow results in the continuous transmission of the last byte stored in the TX FIFO. Likewise, when reading the RX FIFO the MCU must avoid reading the RX FIFO after its empty condition is reached, since a RX FIFO underflow will result in an error in the data read out of the RX FIFO.

When an overflow or an underflow is detected, the MCU has to issue a SABORT and a FLUSHTXFIFO/FLUSHRXFIFO command before resuming the normal transceiver activity. For each FIFO, when one of these errors is detected an interrupt is generated to the MCU.

The S2-LP is capable of automatically retransmitting the last packet that was stored into the FIFO (if NMAX\_RETX > 0 in the PROTOCOL register and no new packet is loaded into the TX FIFO between successive re-transmissions). This feature is useful for “beacon” transmission or when retransmission is required due to absence of a valid acknowledgement. Only packets that fit completely in the TX FIFO are valid for the retransmit feature. When the packet is longer than 128 bytes, the FIFO content after the transmission is only the last part of the payload. In this case, the FIFO must be reloaded by the MCU.

The TX FIFO may be flushed by issuing a FLUSHTXFIFO command (see Table 49. Commands). Similarly, a FLUSHRXFIFO command flushes the RX FIFO.

The full / empty status of the TX / RX FIFO is readable on the bits [9:8] of the MC\_STATE registers, and at the same time, the related IRQs are generated.

In the SLEEP state, the FIFO content is retained only if the SLEEP\_B mode is selected (bit SLEEP\_MODE\_SEL=1 in the register 0x79).

## 5.7 Integrated RCO

The S2-LP contains an ultra-low power RC oscillator with accuracy better than 1%. The RC oscillator frequency is calibrated using as a reference the XO frequency. It depends on two values: raw (4 bits) and fine (5 bits). The raw value is obtained by a linear search algorithm in which for each value a counting of half clock reference inside the period of RCO is done. When the correction is near to the final value, a dichotomy search algorithm starts.

The RCO calibration starts as soon as the RCO\_CALIBRATION bit is set to 1. When it finishes, the RC\_CAL\_OK bit is set and the ERROR\_LOCK bit is reset.

Moreover, after a sleep or standby state, if the RCO\_CALIBRATION bit is kept to 1, when the device returns to the ready state, an RCO calibration automatically runs to compensate some drift.

It is possible to perform an offline calibration of the RCO using the following procedure:

1. Enable the RCO CALIB setting the bit to 1
2. Wait until the RC\_CAL\_OK becomes 1
3. Copy the RWT\_OUT and RFB\_OUT (registers 0x94 and 0x95) out values in the RWT\_IN and RFB\_IN fields (registers 0x6E and 0x6F)
4. Disable the RCO CALIB setting the bit to 0

In this way, the RCO will work with these values. It is advisable to repeat the RCO calibration to reject effects related to the variation of temperature. It is recommended to use this procedure if the following SLEEP time (i.e. when using LDC mode) is shorter or comparable to the calibration time.

By default, the calibration is disabled at reset to avoid using an out-of-range reference frequency, after the internal clock divider is correctly configured, the user can enable the RCO calibration by register.

Once calibrated, the RCO generates a clock frequency that depends on the XO frequency used:

**Table 47. RCO Frequency**

Ref. frequency [MHz]	RCO frequency [kHz]
24 or 48	32
25 or 50	33.33
26 or 52	34.66

## 5.8 Low battery indicator

The battery indicator can provide the user with an indication of the battery voltage level.

There are two blocks to detect battery level:

- Brownout with a fixed threshold
- Battery level detector with a programmable threshold

The MCU enables optionally these blocks to provide an early warning of impending power failure. It does not reset the system, but gives the MCU time to prepare for an orderly power-down and provides hardware protection of data stored in the program memory.

The low battery indicator function is available in any of the S2-LP operation modes. As this function requires the internal bias circuit operation, the overall current consumption in STANDBY, SLEEP, and READY modes increase by 400  $\mu$ A.

## 5.9 Voltage reference

This block provides the precise reference voltage needed by the internal circuit.

## 6 Operating modes

The S2-LP is provided with a built-in main controller which controls the switching between the two main operating modes: transmitter (TX) and receiver (RX), driven by SPI commands.

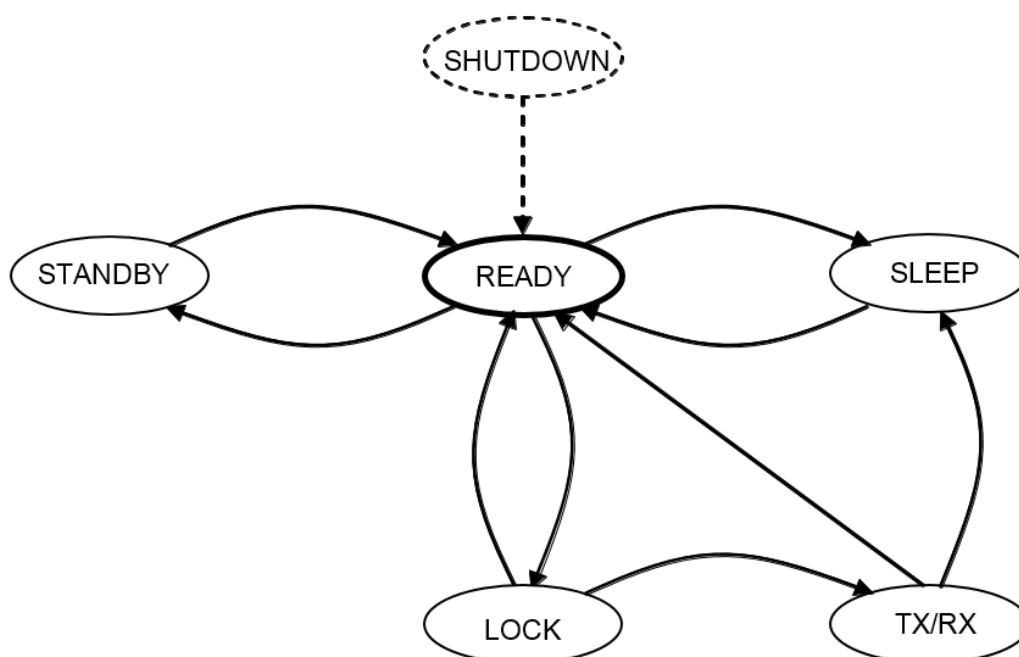
In shutdown condition (the S2-LP can be switched on/off with the external pin SDN), no internal supply is generated, and all stored data and configurations are lost.

From shutdown, the S2-LP can be switched on going to READY state, where the reference clock signal is available.

From READY state, the S2-LP can be moved to LOCK state to generate the high precision LO signal and then in TX or RX modes. Switching from RX to TX and vice versa can happen only by passing through the LOCK state. This operation is managed by the main controller through a single user command (TX or RX). At the end of the operations, the S2-LP can return to READY state or can go to SLEEP state, having a very low power consumption.

SLEEP state can be configured to retain the FIFOs content or not enabling very low power mode. If also no wake-up timer is required, the S2-LP can be moved from READY to STANDBY state, which has the lowest possible current consumption.

Figure 12. State diagram



Three states: READY, STANDBY and LOCK may be defined as stable state.

All other states are transient, which means that, in a typical configuration, the controller remains in those states, at most for any timeout timer duration. Also the READY and LOCK states behave as transients when they are not directly accessed with the specific commands (for example, when LOCK is temporarily used before reaching the TX or RX states).

SYNTH\_SETUP is a stable state that can be accessed if the SABORT command is sent out of its recommended states of execution. If, during SLEEP state, a pair of SABORT and RX (or TX) commands are sent to the device, the device remains in SLEEP, but an incoming READY command leads the device to enter SYNTH SETUP state.

Table 48. State description

State code	State name	Description
NA	SHUTDOWN	No internal power supply is generated
0x02	STANDBY	No wake-up timer active

State code	State name	Description
0x01	SLEEP_A	Wake-up timer active, no FIFO retention
0x03	SLEEP_B	Wake-up timer active, FIFO retention
0x00	READY	Radio in ready state
0x14	LOCKST	Error state due to a failure in LOCK operation
0x0C	LOCKON	High precision LO signal available
0x30	RX	Radio in receiver mode
0x5C	TX	Radio in transmitter mode
0x50	SYNTH_SETUP	Non desirable state reached when a pair of SABORT and RX (or TX) commands are sent during SLEEP state and before sending the READY command
0x7C	WAIT_SLEEP	State entered if, in LDC RX mode, at least one interrupt is generated at the end of the RX cycle

Commands are used in the S2-LP to change the operating mode and to use its functionality. A command is sent on the SPI interface and may be followed by any other SPI access without pulling CSn high. A command code is the second byte to be sent on the MOSI pin (the first byte must be 0x80). The commands are immediately valid after SPI transfer completion (no need for any CSn positive edge).

## 6.1 Command list

**Table 49. Commands**

Command code	Command name	State for execution	Description
0x60	TX	READY, SYNTH_SETUP	Send the S2-LP to TX state for transmission
0x61	RX	READY, SYNTH_SETUP	Send the S2-LP to RX state for reception
0x62	READY	STANDBY, SLEEP, LOCK	Go to READY state
0x63	STANDBY	READY, SYNTH_SETUP	Go to STANDBY state
0x64	SLEEP	READY, SYNTH_SETUP, WAIT_SLEEP	Go to SLEEP state
0x65	LOCKRX	READY, SYNTH_SETUP	Go to LOCK state by using the RX configuration of the synthesizer
0x66	LOCKTX	READY, SYNTH_SETUP	Go to LOCK state by using the TX configuration of the synthesizer
0x67	SABORT	TX, RX	Exit from TX or RX states and go to READY state
0x68	LDC_RELOAD	ANY	Reload the LDC timer with a pre-programmed value stored in registers
0x70	SRES	ANY	Reset the S2-LP state machine and registers values
0x71	FLUSHRXFIFO	All	Clean the RX FIFO
0x72	FLUSHTXFIFO	All	Clean the TX FIFO
0x73	SEQUENCE_UPDATE	ANY	Reload the packet sequence counter with the value stored in register

## 6.2 State transaction response time

**Table 50. Response time**

Initial state	Final state	Response time [ $\mu$ s]
SHUTDOWN	READY	500
READY	STANDBY/ SLEEP	3
READY	LOCK with no VCO calibration	70
READY	LOCK with VCO calibration	85
RX/TX	READY	1
STANDBY/SLEEP	READY	100
LOCK	RX/TX	26

*Note:* The transition time enables the S2-LP for frequency hopping operation due to its reduced response time and very quick programming synthesizer. The response time depends on frequency of the clock in digital domain, from 24 MHz to 26 MHz.

*Note:* The first bit of preamble is sent after TX state is reached, if PA ramping is not enabled. If PA ramping is enabled, the first bit is sent after ramp (see [Section 5.6.1: PA configuration](#)).

## 6.3 Sleep states

S2-LP provides 2 SLEEP states:

- SLEEP without FIFO retention (SLEEP\_A): in this low power state, the device keeps all the register values but not the TX and RX FIFOs. This is the device default SLEEP state.
- SLEEP with FIFO retention (SLEEP\_B): in this low power state, the device keeps the content of the registers and the two FIFOs.

The responsibility of the SLEEP type to be used is demanded to the user. To select the SLEEP mode, the bit SLEEP\_MODE\_SEL (register 0x79) can be used. If this bit is set to 0, SLEEP\_A is used each time the device enters SLEEP (by SPI command, LDC flow or CSMA in non-persistent mode). If it is 1, SLEEP\_B is used instead. The usage of SLEEP\_B mode is mandatory in the configuration like CSMA and LDC in Tx.

## 7 Packet handler engine

The S2-LP offers a highly flexible and fully programmable packet handler (framer and de-framer) that build the packet according to the user configuration settings. The packet types are available: BASIC format, SStack format in which auto acknowledgment and auto retransmission is used, 802.15.4g packet format and UART over the air packet format.

WMBUS format is supported but it can be obtained using the proper features combination.

The RX packet handler is in charge of treating the raw bits produced by the demodulator. The main functions of the RX packet handler are:

- Detect a valid preamble
- Detect a valid synchronization word and start-of-frame
- Extract all packet fields according to the selected packet format
- Perform error correction and interleaving
- Calculate the local CRC and compare to the received one

The device supports 4 different packet formats. The current packet format is set by the PCK\_FRMT field of the PKTCTRL3 register.

In particular:

- 0: Basic packet format
- 1: 802.15.4g packet format
- 2: UART over the air packet format
- 3: SStack packet format

### 7.1 BASIC packet format

The packet format BASIC is selected by writing 0b in the register PCK\_FRMT. The packet frame is as follows:

**Table 51. BASIC packet format**

Preamble	Sync	Length	Address	Payload	CRC	Postamble
0:2046 bits	0:32 bits	0:2 bytes	0:1 bytes	0:65535 bytes	0:4 bytes	0:510 bits

- **Preamble:** each preamble is a pair of '01' or '10' from 0 pair to 1023 pairs, programmed by the register PREAMBLE\_LENGTH. The binary sequences transmitted in the various modulation modes are summarized in the following table (leftmost bit is transmitted first).

**Table 52. Preamble field selection**

PREAMBLE_SEL	2(G)FSK or OOK/ASK	4(G)FSK
0	0101	0111
1	1010	0010
2	0011	1101
3	1100	1000

- **Sync:** the pattern that identify the start of the frame can be configured in value with a programmable length from 0 to 32 bits, in steps of 1-bit length. The setting is done by the register SYNC\_LENGTH. The S2LP supports dual synchronization with a either a primary or a secondary synchronization word. The binary content of the primary SYNC word is programmable through registers SYNCx (x= 0, 1, 2, 3). The binary content of the secondary SYNC word is programmable through registers SEC\_SYNCx (x= 0, 1, 2, 3), note that such registers are in alternate use with address filtering registers. On the transmitter side either the primary or the secondary word is transmitted according to the value of the SECONDARY\_SYNC\_SEL register, in particular if SECONDARY\_SYNC\_SEL = 0 then the primary synchronization word is transmitted; if SECONDARY\_SYNC\_SEL = 1 then the secondary synchronization word is transmitted. On the receiver side, the primary synchronization word is always enabled. The search for the secondary synchronization word can be enabled setting SECONDARY\_SYNC\_SEL = 1b. In this case, both the binary patterns are searched for and both of them can trigger the start of payload demodulation. The SQI[5:0] value reported in the LINQ\_QUALIF register is the maximum between the SQI of the primary and secondary words. The bit SQI[6] indicates which synchronization word has been detected: in particular, if the secondary synchronization word has been detected then the SQI[6] = 1b otherwise if the primary synchronization word has been detected then SQI[6] = 0b. The binary pattern programmed in SYNCx (or SEC\_SYNCx) is transmitted on air starting with the most significant bit of x = 1, to the least significant bit of x = 4 according to the programmed synchronization word length.
- **Length:** The device supports both fixed and variable packet length transmission from 0 to 65535 bytes. On the transmitting device, the packet length is always set by using the two registers PCKTLENx (x= 1, 2) as: PCKTLEN1 × 256 + PCKTLEN0. On the receiving device, if FIX\_VAR\_LEN register is set to '1', the packet length is directly extracted from the field Length of the received packet itself. If the register FIX\_VAR\_LEN = 0b the Length field of the received packet is not used, because is already known from the registers PCKTLENx (x= 1, 2) as for the transmitter. For the basic and stack packet formats, the number of address bytes is also counted in the packet length value. CRC is excluded. Furthermore, when variable packet length is used (FIX\_VAR\_LEN=1b), the width of the binary field transmitted, must be configured through the LEN\_WID register in the following way:
  - If the packet length is from 0 to 255 bytes (payload + address field), then LEN\_WID = 0b (1 byte length field transmitted).
  - If the packet length is from 0 to 65535 bytes (payload + address field), then LEN\_WID = 1b (2 bytes length field transmitted).
- **Destination address:** can be enabled or no by the register ADDRESS\_LEN. If enabled, ADDRESS\_LEN=1b, its size is 1 byte. The destination address field is read from the register RX\_SOURCE\_ADDR (TX only). The receiver uses this field to perform automatic filtering on its value programmed in TX\_SOURCE\_ADDR (RX only).
- **Payload:** the main data from transmitter with a max length up to 65535 supported by the embedded automatic packet handler.
- **CRC:** can optionally be calculated on the transmitted data (Length field, Address field and Payload) and appended at the end of the payload (see [Section 7.9: CRC](#)).
- **Postamble:** The packet postamble allows inserting a certain number of '01' bit pairs at the end of the data packet. The number of postamble bit pairs can be set through the MBUS\_PSTMBL register.

## 7.2 SStack packet

**Table 53. SStack packet**

Preamble	Sync	Length	Dest. address	Src address	Seq num	NO_ACK	Payload	CRC	Postamble
0:2046 bits	0:32 bits	0:2 bytes	1 bytes	1 bytes	2 bits	1 bit	0:65535 bytes	0:4 bytes	0:510 bits

- **Preamble:** each preamble is a pair of '01' or '10' from 0 pair to 1023 pairs, programmed by the register PREAMBLE\_LENGTH. The binary sequences transmitted in the various modulation modes are summarized in [Table 52. Preamble field selection](#) (leftmost bit is transmitted first).

- **Sync:** the pattern that identify the start of the frame can be configured in value with a programmable length from 0 to 32 bits, in steps of 1-bit length. The setting is done by the register SYNC\_LENGTH. The S2LP supports dual synchronization with a either a primary or a secondary synchronization word. The binary content of the primary SYNC word is programmable through registers SYNCx (x= 0, 1, 2, 3). The binary content of the secondary SYNC word is programmable through registers SEC\_SYNCx (x= 0, 1, 2, 3), note that such registers are in alternate use with address filtering registers. On the transmitter side either the primary or the secondary word is transmitted according to the value of the SECONDARY\_SYNC\_SEL register, in particular if SECONDARY\_SYNC\_SEL = 0 then the primary synchronization word is transmitted; if SECONDARY\_SYNC\_SEL = 1 then the secondary synchronization word is transmitted. On the receiver side, the primary synchronization word is always enabled. The search for the secondary synchronization word can be enabled setting SECONDARY\_SYNC\_SEL = 1b. In this case, both the binary patterns are searched for and both of them can trigger the start of payload demodulation. The SQI[5:0] value reported in the LINK\_QUALIF register is the maximum between the SQI of the primary and secondary words. The bit SQI[6] indicates which synchronization word has been detected: in particular, if the secondary synchronization word has been detected then the SQI[6] = 1 otherwise if the primary synchronization word has been detected then SQI[6] = 0. The binary pattern programmed in SYNCx (or SEC\_SYNCx) is transmitted on air starting with the most significant bit of x = 1, to the least significant bit of x = 4 according to the programmed synchronization word length.
- **Length:** The device supports both fixed and variable packet length transmission from 0 to 65535 bytes. On the transmitting device, the packet length is always set by using the two registers PCKTLENx (x= 1, 2) as: PCKTLEN1 × 256 + PCKTLEN0. On the receiving device, if FIX\_VAR\_LEN register is set to '1', the packet length is directly extracted from the field Length of the received packet itself. If the register FIX\_VAR\_LEN = 0b the Length field of the received packet is not used, because is already known from the registers PCKTLENx (x= 1, 2) as for the transmitter. Furthermore, when variable packet length is used (FIX\_VAR\_LEN=1b), the width of the binary field transmitted, must be configured through the LEN\_WID register in the following way:
  - If the packet length is from 0 to 255 bytes (payload + address field), then LEN\_WID = 0 (1 byte length field transmitted).
  - If the packet length is from 0 to 65535 bytes (payload + address field), then LEN\_WID = 1 (2 bytes length field transmitted).
- **Destination address:** the receiver uses this field to perform automatic filtering on its value. It is a mandatory field always on. The destination address field is read from the register RX\_SOURCE\_ADDR (TX only).
- **Source address:** the receiver uses this field to perform automatic filtering on its value. It is a mandatory field always on. The source address field is read from the register TX\_SOURCE\_ADDR (TX only).
- **Sequence number:** it is a 2 bits field and contains the sequence number of the transmitted packet. It is incremented automatically every time a new packet is transmitted. It can be manually updated with the SEQUENCE\_UPDATE command. Since the S2-LP loses the sequence number, it is necessary to store it on the MCU at the end of the transaction and then recover it after the stand-by session.
- **NO\_ACK:** it is 1 bit field that notify to the receiver if the packet has to be acknowledged or not. This bit must be used only in SStack packet format.
- **Payload:** the main data from transmitter with a max length up to 65535 supported by the embedded automatic packet handler.
- **CRC:** can optionally be calculated on the transmitted data (Length field, Destination Address field, Source Address field, Sequence Number, No Ack and Payload) and appended at the end of the payload (see [Section 7.9: CRC](#)).
- **Postamble:** The packet postamble allows inserting a certain number of '01' bit pairs at the end of the data packet. The number of postamble bit pairs can be set through the MBUS\_PSTMBL register.

## 7.3 802.15.4g packet

**Table 54. 802.15.4g packet**

Preamble	Sync	PHR	MHR + MAC payload	CRC
0:2046 bits	0:32 bits	2 bytes	2:2047 bytes	0:4 bytes

- **Preamble:** each preamble is a pair of '01' or '10' from 0 pair to 1023 pairs ( in the table we write 2046 bits), programmed by the register PREAMBLE\_LENGTH. The binary sequences transmitted in the various modulation modes are summarized in [Table 52. Preamble field selection](#) (leftmost bit is transmitted first).
- **Sync:** the pattern that identify the start of the frame can be configured in value with a programmable length from 0 to 32 bits, in steps of 1-bit length. The setting is done by the register SYNC\_LENGTH. The S2LP supports dual synchronization with a either a primary or a secondary synchronization word. The binary content of the primary SYNC word is programmable through registers SYNCx (x= 0, 1, 2, 3). The binary content of the secondary SYNC word is programmable through registers SEC\_SYNCx (x= 0, 1, 2, 3), note that such registers are in alternate use with address filtering registers. On the transmitter side either the primary or the secondary word is transmitted according to the value of the SECONDARY\_SYNC\_SEL register, in particular if SECONDARY\_SYNC\_SEL = 0, the primary synchronization word is transmitted; if SECONDARY\_SYNC\_SEL = 1 then the secondary synchronization word is transmitted. On the receiver side, the primary synchronization word is always enabled. The search for the secondary synchronization word can be enabled setting SECONDARY\_SYNC\_SEL = 1b. In this case, both the binary patterns are searched for and both of them can trigger the start of payload demodulation. The SQI[5:0] value reported in the LINK\_QUALIF register is the maximum between the SQI of the primary and secondary words. The bit SQI[6] indicates which synchronization word has been detected: in particular, if the secondary synchronization word has been detected then the SQI[6] = 1b otherwise if the primary synchronization word has been detected then SQI[6] = 0b. The binary pattern programmed in SYNCx (or SEC\_SYNCx) is transmitted on air starting with the most significant bit of x = 1, to the least significant bit of x = 4 according to the programmed synchronization word length. For the 802.15.4g packet format, the secondary synchronization word is automatically selected on the TX side only, when FEC is enabled (FEC\_EN = 1) and the setting of SECONDARY\_SYNC\_SEL is ignored.
- **PHR:** The PHR (physical header) field is specific for the 802.15.4g packet format and is automatically built by the packet handler block based on current register configuration.

**Table 55. PHR frame**

Bit string index	0	1-2	3	4	5-15
Bit mapping	MS	R <sub>1</sub> -R <sub>0</sub>	FCS	DW	L <sub>10</sub> -L <sub>0</sub>
Field name	Mode switch	Reserved	FSC type	Data whitening	Frame length

In particular:

- MS is always set to 0b (mode switch not supported).
- R<sub>1</sub>-R<sub>0</sub> are always set to 00b.
- FCS is set to:
  - 0b if CRC mode 5 is selected.
  - 1b if CRC mode 3 is selected.
- DW is set to:
  - 0b if whitening is disabled, register WHIT\_EN = 0.
  - 1b if whitening is enabled, register WHIT\_EN = 1.
- L<sub>10</sub>-L<sub>0</sub> are set equal to the 11 bits LSB of the packet length registers set by using the two registers PCKTLENx (x= 1, 2) as: PCKTLEN1 × 256 + PCKTLEN0. The packet length is from 0 to 65535 bytes (MHR + MAC Payload + CRC), then LEN\_WID = 1b (2 byte length field transmitted).
- **Payload:** the main data from transmitter with a max length up to 65535 supported by the embedded automatic packet handler.
- **CRC:** can optionally be calculated on the transmitted data (MHR + MAC Payload) and appended at the end of the payload (see [Section 7.9: CRC](#))

- In the 802.15.4g the CRC, named FCS in the standard, is considered part of the PSDU (PHY payload) hence the packet length, must include the 2 or 4 CRC bytes:
  - If the packet length programmed in PCKTLEN1 and PCKTLEN0 is L and CRC mode is 3, then L-2 bytes are read/written from/to the TX/RX FIFO and interpreted as MHR + MAC Payload, 2 bytes CRC are automatically calculated and inserted at the end of the packet in transmission and stripped in reception.
  - If the packet length programmed in PCKTLEN1 and PCKTLEN0 is L and CRC mode is 5, then L-4 bytes are read/written from/to the TX/RX FIFO and interpreted as MHR + MAC Payload, 4 byte CRC are automatically calculated and inserted at the end of the packet in transmission and stripped in reception.
  - If CRC mode is 0, then L bytes are read/written from/to the TX/RX FIFO and interpreted as MHR + MAC Payload + MCS. In this case no CRC calculation, insertion/stripping is done, and it is the responsibility of the MAC layer to process it.

For CRC mode 3, according to the standard specifications, the CRC output is complemented to 1 before transmission.

For CRC mode 5, if the payload length is less than 4 bytes then the payload is zero-padded to reach a minimum length of 4 bytes. The padding bits are only used to compute the CRC and are not transmitted on-air. The reverse operation is automatically performed on the receiver.

## 7.4 UART over the air packet format

**Table 56. UART over the air packet format**

Preamble	Sync	Payload
0:2046 bits	0:32 bits	0:65535 bytes

When this format is selected, a start bit and a stop bit can be programmed to be added to each byte of the TX FIFO. Such start and stop bits are automatically removed from the received payload before written to the RX FIFO. Start and stop bits are not added to the SYNC word.

Also, the BYTE\_SWAP bit can be set in order to send the FIFO bytes in LSbit first (default is indeed MSbit first). The actual binary value of the start and stop bit can be set through the START\_BIT and the STOP\_BIT fields of the PCKTCTRL2 register.

## 7.5 Wireless MBUS packet (W-MBUS, EN13757-4)

The W-MBUS packet structure referred to EN13757 can be obtained through registers setting programming the basic packet to fit the specific sub-mode used.

Preamble	Sync	1 <sup>st</sup> block	2 <sup>nd</sup> block	Opt. blocks	Postamble
----------	------	-----------------------	-----------------------	-------------	-----------

**Preamble:** the preamble is fully programmable to fit the W-MBUS protocol. The generic setting is a pair of '01' or '10' from 1 pair to 1024 pairs (max. 256 bytes).

**Sync:** the pattern that identify the start of the frame is fully programmable to fit the W-MBUS protocol. The generic setting is in value with a programmable length from 1 bit to 64 bytes, in steps of 1-bit length.

**Data blocks:** the data coding can be fully programmed in NRZ, Manchester or 3-out-of-6.

**Postamble:** The packet postamble allows inserting a certain number of '01' bit pairs at the end of the data packet. The number of postamble bit pairs can be set through the MBUS\_PSTMBL register depending on the chosen sub-mode according to the W-MBUS protocol.

## 7.6 Payload transmission order

The bit order of the data from TX FIFO and written into the RX FIFO is controlled by the BYTE\_SWAP register. In particular, the transmission is MSB first if BYTE\_SWAP = 0 and LSB first if BYTE\_SWAP = 1.

## 7.7 Automatic packet filtering

The receiver uses the following filtering criteria to reject the received packet. The automatic filtering is supported in BASIC and SStack packet format only.

- **CRC:** the received packet is discarded if CRC check fails. Both transmitter and receiver must be configured with same CRC polynomial.
- **Destination address vs my address:** the received packet is discarded if the destination address field received does not match the programmed my address of the receiver.
- **Destination address vs. broadcast address:** the received packet is discarded if the destination address field received does not match the programmed broadcast address of the receiver.
- **Destination address vs. multicast address:** the received packet is discarded if the destination address field received does not match the programmed multicast address of the receiver.
- **Source address:** the received packet is discarded if the source address received does not match the programmed source address reference (a bit mask can be included). Supported in SStack packet format only.

The automatic filtering can be programmed to discard packet below certain threshold settings. These kind of filtering are general purpose and can be used with any packet format.

- **Carrier sense:** The carrier sense (CS) functionality detects if any signal is being received, the detection is based on the measured RSSI value. There are 2 operational modes for carrier sensing: static and dynamic. In static CS mode, the CS is high when the measured RSSI is above the RSSI threshold specified and is low when the RSSI is 3 dB below the threshold. In dynamic CS mode, the CS is high if the signal is above the threshold and a fast power increase of 6, 12, or 18 dB is detected. The CS is also used internally for the demodulator to start the AFC and timing recovery algorithms and for the CSMA procedure (static CS mode only).
- **PQI:** It is possible to set a PQI threshold in such a way that, if PQI is below the threshold, the packet demodulation is automatically aborted.
- **SQI:** It is possible to set a SQI threshold in such a way that, if SQI is below the threshold, the packet demodulation is automatically aborted. When the SQI threshold is set at 0, a perfect match is required. It is recommended to always enable the SQI check.

## 7.8 Data coding and integrity check

### 7.8.1 FEC

The device provides hardware support for error correction and detection.

Error correction can be either enabled or disabled according to link reliability and power consumption needs.

Convolution coding (rate 1/2) and interleaving (FEC) can optionally be applied to the data. FEC can be enabled by setting the FEC\_EN register. When FEC is enabled the number of transmitted bits is roughly doubled hence the on-air packet duration in time is roughly double as well. The data rate specified in section always applies to the on-air transmitted data.

FEC is applied to all the fields of BASIC and SStack packet format, except Preamble, Sync and Postamble. While is applied to all the fields except Preamble and Sync for the 802.15.4g packet format.

For the 802.15.4g packet format, two different coding schemes can be selected depending on the setting of the FEC\_TYPE\_4G register. In particular if FEC\_TYPE\_4G = 0 then the NRNSC encoder is selected, otherwise the RSC one is selected. Please note that the NRNSC encoder for 802.15.4g is the same as the one used in Basic and SStack formats with logical inversion of the output symbols.

When FEC is enabled then the transmitter automatically selects the secondary SYNC word. On receiver side, a FEC coded frame is recognized by the reception of such secondary SYNC word and FEC is automatically activated independently of the setting of the FEC\_EN register.

Use of FEC coding is exclusive with Manchester and Three-out-of-six coding.

#### 7.8.1.1 Interleaving

In order to improve the effectiveness of convolutional encoding, matrix interleaving is applied to the encoded data at the output of the convolutional encoder.

The symbols from the output of the encoder are written row-wise into a 4x4 matrix buffer starting from the upper-left cell and read column-wise starting from the lower-right cell.

Each pair of encoded symbols corresponding to one single encoded bit is packet into a single matrix cell. For each encoded symbols pair  $s_0(n)$  is transmitted first on air,  $s_1(n)$  is transmitted second.

Note that interleaving is always enabled together with FEC for the Basic and SStack packet formats while it can be optionally enabled in the case of the 802.15.4g packet format by setting to '1' the INT\_EN\_4G register.

### 7.8.2 Manchester coding

Manchester coding can be enabled for the Basic and SStack packet formats only by setting to '1' the MANCHESTER\_EN register.

Manchester coding is not compatible with FEC and Three-out-of-six coding.

When Manchester coding is enabled each bit '1' is actually transmitted on air as a '10' sequence while a bit '0' is transmitted as a '01' sequence. If enabled, Manchester encoding is applied to all bits following the SYNC word.

### 7.8.3 3-out-of-6 coding

The 3-out-of-6 coding is a form of block coding that can be enabled for the Basic packet format for compatibility with the MBUS standard setting to '1' the MBUS\_3OF6\_EN bit of PCKTCTRL2. This coding is not expected to be used in other packet formats and is exclusive with FEC and Manchester coding.

Coding is done according to the table below.

**Table 57. 3-out-of-6 coding scheme**

NRZ code	NRZ-decimal	6-bit code	6-bit decimal	N. of transitions
0000	0	010110	22	4
0001	1	001101	13	3
0010	2	001110	14	2
0011	3	001011	11	3
0100	4	011100	28	2
0101	5	011001	25	3
0110	6	011010	26	4
1000	8	101100	44	3
1001	9	100101	37	4
1010	10	100110	38	3
1011	11	100011	35	2
1100	12	110100	52	3
1101	13	110001	49	2
1110	14	110010	50	3
1111	15	101001	41	4

## 7.9 CRC

Error detection is implemented by means of cyclic redundancy check codes. The CRC is calculated over all fields excluding preamble and SYNC word. The length of the checksum is programmable to 8, 16, 24 or 32 bits. The following standard CRC polynomials can be selected:

- mode 1: 8 bits: the poly is (0x07)  $X^8+X^2+X+1$
- mode 2: 16 bits: the poly is (0x8005)  $X^{16}+X^{15}+X^2+1$
- mode 3: 16 bits: the poly is (0x1021)  $X^{16}+X^{12}+X^5+1$
- mode 4: 24 bits: the poly is (0x864CFB)  $X^{24}+X^{23}+X^{18}+X^{17}+X^{14}+X^{11}+X^{10}+X^7+X^6+X^5+X^4+X^3+X+1$
- mode 5: 32 bits the poly is (0x4C11DB7)  $x^{32}+x^{26}+x^{23}+x^{22}+x^{16}+x^{12}+x^{11}+x^{10}+x^8+x^7+x^5+x^4+x^2+x+1$ .  
802.15.4g compatible

The initial state of the CRC polynomial is state to all 1b in all cases.

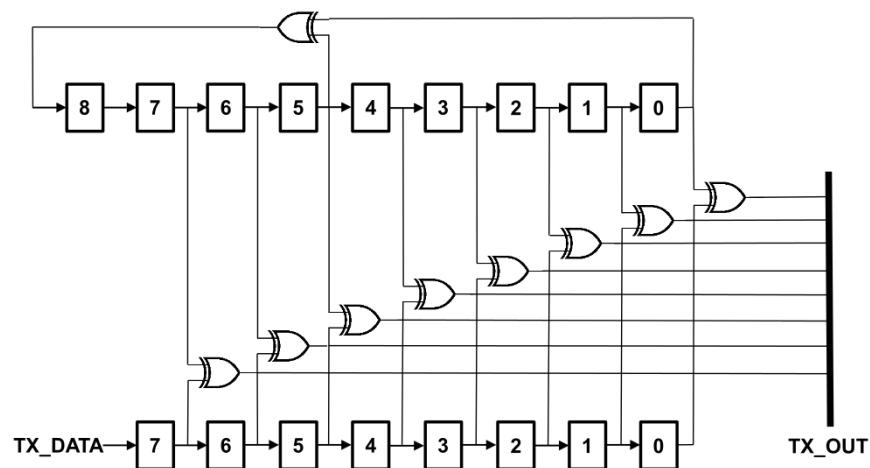
## 7.10 Data whitening

To prevent short repeating sequences (e.g., runs of 0's or 1's) that create spectral lines, which may complicate symbol tracking at the receiver or interfere with other transmissions, the device implements a data whitening feature. Data whitening is implemented with a maximum length LFSR generating a pseudo-random binary sequence used to XOR data before entering the encoding chain. The length of the LSFR is set to 9 bits. The pseudo-random sequence is initialized to all 1's. When enabled through WHIT\_EN register, the data are scrambled before being transmitted in such a way that long sequences of zeros or ones become very unlikely and physical layer algorithms perform better.

At the receiver end, the data are XOR-end with the same pseudo-random sequence. Whitening is applied according to the following LFSR implementation. Data whitening is always recommended.

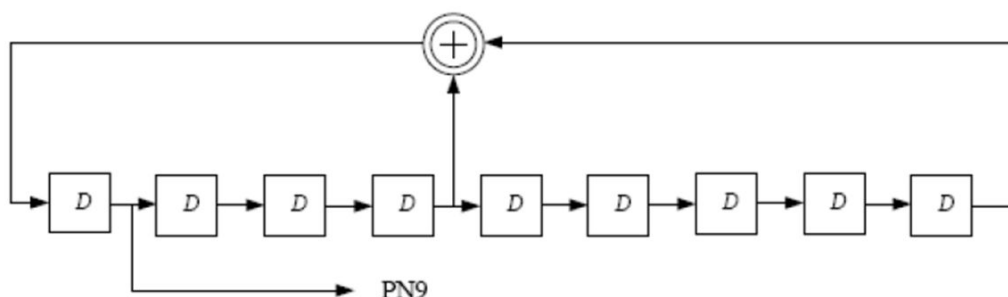
Data whitening is applied on all fields excluding the preamble, the SYNC words and the postamble for BASIC and SStack packet format according to the following scheme:

Figure 13. Data whitening scheme



In the case of 802.15.4g packet format, on the receiver side, the use of whitening is signaled for each packet by one specific bit of the received PHR hence the WHIT\_EN value is only used on the transmitter side. According to the standard, if enabled, whitening is applied to all fields following the PHR field, and is performed according to the following block diagram:

Figure 14. Data whitening scheme 802.15.4g



## 8 Link layer protocol

### 8.1 Automatic acknowledgment

The automatic acknowledgment embedded in the S2-LP allows the receiver to send back to the transmitter an ACK packet to confirm the reception of a packet. The automatic acknowledgement must be configured in receiver side by setting the register `AUTO_ACK = 1b`.

In transmitter side, the ACK request must be set according to the `NACK` field of the packet: when the register `NACK = 0b` the `NO_ACK` field is '0' that represents an ACK request.

Once the transmitter has sent a packet with an ACK request, it will wait for the ACK packet using the usual RX configuration: so the RX timer must be set according to the data rate, as well the receiver channel filter bandwidth and SQI. If the transmitter does not receive any ACK packet when it must, the packet transmitted is considered lost, and there is no `TX_DATA_SENT` IRQ notification.

The ACK packet sent is formatted as follows:

- The destination address field shall be set equal to the source address field of the received packet.
- The source address field shall be filled with content of register `TX_SOURCE_ADDR`.
- The sequence number of the ACK packet will be the same as the received packet.
- The control field shall be set accordingly to any pre-negotiated configuration.
- The main controller shall check if the `PIGGYBACKING` bit flag is set:
  - If it is set, it checks if there is any data in the TX FIFO: if found, it is transmitted in the payload field
- If any of the above checks fail, no payload is transmitted: an empty packet is sent which contains only the source and destination addresses and the sequence number of the packet being acknowledged. Anyway, the TX FIFO is read at list once, consequently generating an underflow condition in case of empty FIFO. To clear the FIFO, a `FLUSHTXFIFO` command is needed.
- The `NO_ACK` flag shall be set to either to '1' (no explicit acknowledgment).

*Note: An ACK packet is considered received (there is no explicit way to signal that a packet is an ACK packet or not. If, after having sent a packet requiring acknowledgement, the transmitter receives a packet from the receiver with the same sequence number, it shall assume that this is an ACK packet.) if and only if it is not discarded for RX timeout, or filtered and its sequence number match that of the sent packet.*

If the automatic acknowledgment is enabled (receiver side), the TX command is not supported and must not be used.

In case of packet with fixed payload length, since the 'empty packet' does not contain any payload (as `PIGGYBACKING` bit is not set), the receiver could not be able to de-frame the packet. So the packet option having fixed payload length but no piggybacking is not supported by S2-LP.

The S2-LP device cannot operate at the same time in auto-acknowledge and auto-Re-TX modes (one at a time only).

The automatic acknowledgement is supported for SStack packet format only.

The TX device is not able to receive any packets if the `CSMA_ON` bit is set to 1 (the RX operation works only for carrier sensing). To be able to receive the ACK packet, the `CSMA_ON` bit is set to 0b before switching to RX state.

#### 8.1.1 Automatic acknowledgment with piggybacking

The receiver can fill the ACK packet with data. The mode piggybacking must be set and the TX FIFO must be filled with the payload to transmit.

When the transmitter uses the piggybacking to fill the ACK packet, a further automatic acknowledgment and/or retransmission are not explicitly supported. The transmitter, can determine if its piggybacked packet was received or not by the fact that the initiator will retransmit the original packet or not. Simply stated:

- If the receiver does not retransmit its packet, it means that he has correctly received the acknowledgment, hence the piggybacked packet, so everything is fine.
- If the initiator retransmits its packet, then the destination shall re-acknowledge it and just resend the piggyback packet again.

### 8.1.2 Automatic retransmission

If the transmitter does not receive the requested ACK packet, it can be configured to do other transmissions. The maximum number of transmission configurable is 16 and it is specified in the register NMAX\_RETX (allowed value are from 0 to 15, setting it to '0' disables the feature). The current number of TX attempts is readable in the N\_RETX register. At the end of the automatic retransmission procedure, the register N\_RETX contains the effective number of attempts done (NMAX\_RETX + 1 at most, in this case the interrupt "Max Re-TX reached" is generated and the TX FIFO is not cleared, MCU decides whether to flush the TX FIFO or not).

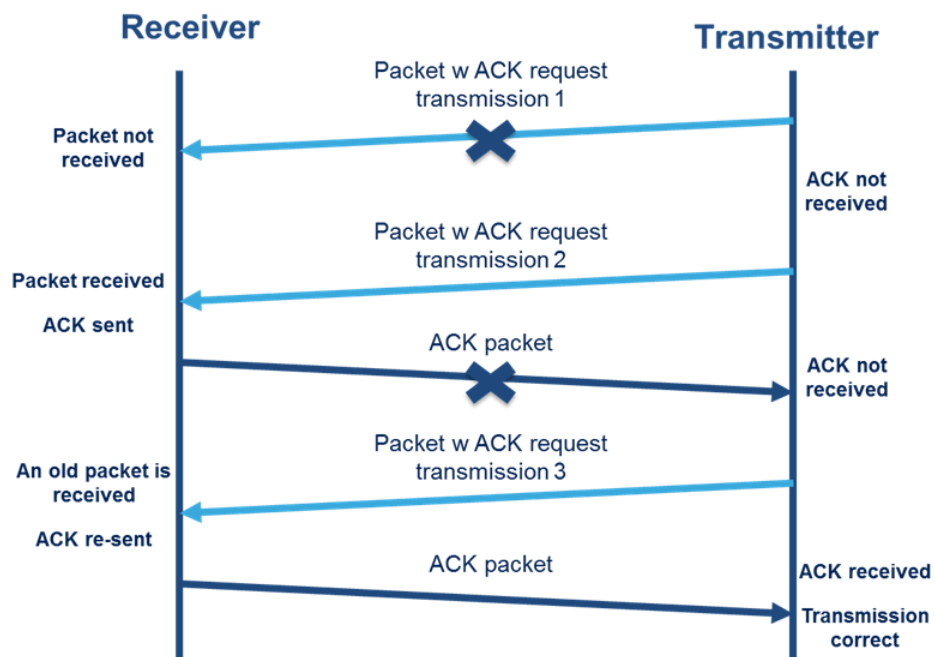
The TX FIFO does not need to be filled again for the retransmission, but must be loaded with a single write FIFO operation.

If the automatic retransmission is enabled (transmitter side), the RX command is not supported and must not be used.

In Figure 15. Automatic retransmission scenario a possible scenario is shown:

1. The receiver does not fulfill the ack request of the first transmission because does not receive the packet.
2. The transmitter send again the packet, but in this case is the ack packet to be lost. So, the communication fails again.
3. The transmitter send again the packet and receive the ack packet. The communication is working correctly this time.

Figure 15. Automatic retransmission scenario



## 8.2 Timeout protocol engine

The S2-LP provides programmable timers to reach the lowest low power consumption while at the same time keeping an efficient communication link.

Table 58. Timer description and duration (the values are related to  $f_{dig}$  of 26 MHz)

Timer name	Description	$f_{source}$	Time step [μs]	Max. time	Formula
RX timer	Once is expired the reception ends	$\frac{f_{dig}}{1210}$	~46	~3s	$\frac{1}{f_{source}} * ((PRESCALER + 1) * COUNTER - 1)$ PRESCALER : register 0x47 COUNTER: register 0x46

Timer name	Description	$f_{source}$	Time step [μs]	Max. time	Formula
LDC timer <sup>(1)</sup>	Set the wake-up period during LDC operations	$f_{rco}, \frac{f_{rco}}{2}, \frac{f_{rco}}{4}, \frac{f_{rco}}{8}$	~29 ~58 ~116 ~232	~2s ~4s ~8s ~16s	$\frac{1}{f_{source}} * (PRESCALER + 1) * (COUNTER + 1)$ PRESCALER : register 0x48, 0x4A COUNTER: register 0x49, 0x4B
Sniff timer	RSSI settling time before valid carrier sense	$\frac{F_{dig}}{24} 2^{CHFLT\_E}$	1 μs - 473 μs	235 μs - 120 ms	$\frac{1}{f_{source}} * FAST\_RX\_TIMER$ FAST_RX_TIMER : register 0x54

1. The LDC timer can be scaled by 1, 2, 4 or 8.

### 8.2.1 Low duty cycle mode

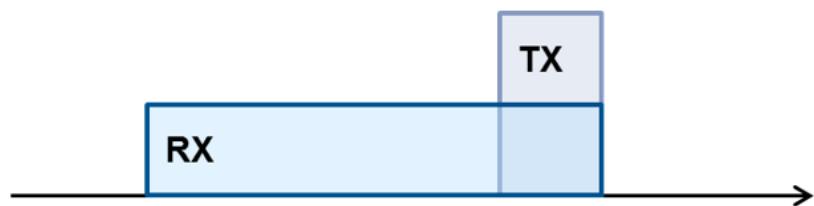
The S2-LP provides an embedded low duty cycle mode (LDC), that allows reducing the average power consumption during receive operations and to build a synchronized start network where both transmitter and receiver can go in low power mode periodically to reduce average power consumption.

The LDC mode is controlled essentially by the LDC timer, which periodically wakes up the S2-LP to perform a transmission or a reception.

In reception mode, it is also relevant to set up the RX timer in order to minimize the amount of time the S2-LP waits for a packet. The RX timer defines the RX windows within a valid SYNC word should be detected.

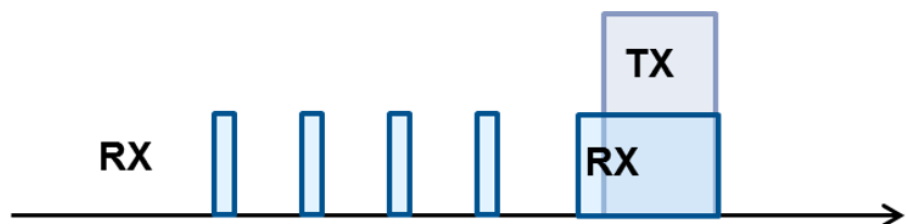
As shown in Figure 16. Common RX operation, a common receiver usually stays in RX state for long time waiting of the TX packet.

Figure 16. Common RX operation



Using the LDC mode, the S2-LP wakes up periodically saving a lot of power.

Figure 17. LDC RX operation



If synchronization between transmitter and receiver is required, a programmable timer value can be reloaded at SYNC word detection by the receiver or by SPI command.

The timer used to wait for the wakeup ( $T_{WU}$ ) is clocked by the signal generated by the RCO circuit (or by an external clock from a GPIO pin), and is programmable with the registers LDC\_PRESCALER and LDC\_COUNTER. The internal RC oscillator used by the LDC timer must be calibrated just before the LDC mode is used.

After the wake-up signaling from its internal timer, the S2-LP switches to RX (TX) state and an interrupt request is issued (if enabled and not masked). In order to allow for analog circuits settling, an idle time  $T_{IDLE}$  should be allowed before effective operation: the effective reception starting time is related to the synchronization with the sender. The idle time could result longer than the minimum required to get RX circuits settling, and this cause power wasting. In order to minimize the TIDLE, S2-LP supports the runtime phasing of the internal wake-up timer, as follows:

- For both RX and TX devices, the value of the wake-up timer can be reloaded during runtime using the LDC\_RELOAD command with the values written in the LDC\_RELOAD\_PRESCALER and LDC\_COUNTER registers. In so doing, the counting can be delayed or anticipated.
- Only for the RX device, the wake-up timer can be automatically reloaded at the time the SYNC is received. This option must be enabled on the PROTOCOL register.

The estimation of the values to be reloaded in order to get optimal LDC phasing is in charge of the MCU, which should be synchronized with the S2-LP RCO using any of the available clock outputs.

The details about LDC operation for the RX device are the following:

1. The starting state is READY: as soon as user sets the LDC\_MODE bit, LDC counter starts in free running mode.
2. The first RX operation is triggered by the RX command.
3. First RX should be executed with a long (or infinite) timeout (LDC counter is still free running, not synchronized).
4. After first RX, the user should synchronize the LDC counter by using the LDC\_RELOAD command.
5. Synchronization could be automatically triggered by the detection of the SYNC word.
6. After each RX, the state machine runs as follows:
  - a. If no pending interrupt ( $nIRQ=1$ ), then automatically go to SLEEP for LDC, but only after RCCAL\_OK goes to 1 (RCO calibration complete).
  - b. If any pending interrupt ( $nIRQ=0$ ), then stay in WAIT\_SLEEP (MCU sends a SLEEP command to go to SLEEP and resume LDC operation).
7. If FIFOs are not retained in SLEEP, then the MCU must read the RX FIFO during the READY state, before giving the SLEEP command.
8. When the LDC\_MODE bit is reset, the LDC counters continues decrementing and
  - a. If the LDC\_MODE bit is cleared during SLEEP mode, then the LDC timer does not wakes up the device any longer. A READY command is needed from MCU.
  - b. If the LDC\_MODE bit is cleared during the RX operation (so when still in active mode), then the device enters READY state at the end of the RX.

The details about LDC operation for the TX device are the following:

1. The starting state is READY: as soon as user sets the LDC\_MODE bit, LDC counter starts in free running mode.
2. The first TX operation is triggered by the TX command.
3. First TX is executed always (even if TX FIFO is empty); the next happens only if TX FIFO is not empty.
4. At first TX, the LDC counter automatically is reloaded.
5. If TX FIFO is empty, the current slot is skipped and the device remains in SLEEP state.
6. The TX FIFO can be written during the SLEEP state also.
7. When the LDC\_MODE bit is reset, the LDC counter continues decrementing and
  - a. If the LDC\_MODE bit is cleared during SLEEP mode, then the LDC timer does not wakes up the device any longer. A READY command is needed from MCU.
  - b. If the LDC\_MODE bit is cleared during the TX operation (so when still in active mode), then the device enters READY state at the end of the TX.

However, it is also true that:

- a. In case the TX FIFO is empty, the device still remains in SLEEP state until the FIFO is written or a READY command is provided.
- b. In case the TX FIFO is not empty, a last TX operation is performed before the LDC stops.

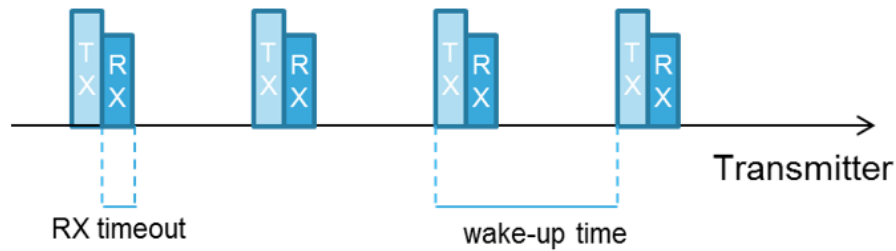
For the TX, the bit SLEEP\_MODE\_SEL should be set to 1, selecting the SLEEP\_B mode. In this way, the TX\_FIFO can be written in SLEEP.

### 8.2.1.1 Automatic acknowledgment

The LDC mode can be used together with the automatic acknowledgment. In this case during a single LDC cycle both the operations of reception and transmission are performed.

In case of TX, the device wakes up every WAKE-UP time and switches to RX for the RX\_TIMEOUT set waiting for an ack.

Figure 18. LDC in TX with auto-ack

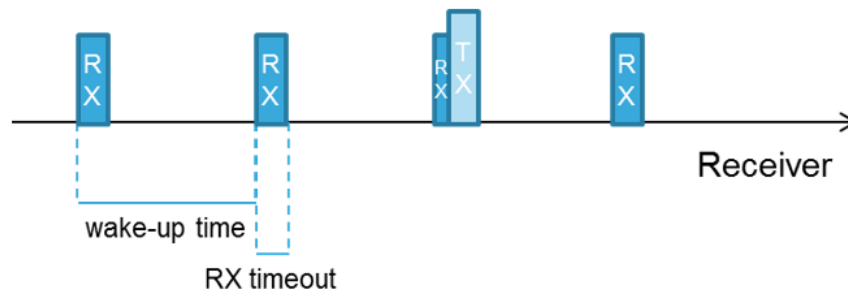


On each wake-up slot, the S2-LP enters TX only if the TX-FIFO is not empty, otherwise the TX slot is skipped with the device remaining in SLEEP.

In this case, the TX-FIFO must be retained during the SLEEP state, thus, the SLEEP\_B must be selected setting the SLEEP\_MODE\_SEL bit to 1.

In case of RX the device enters RX and waits for a packet, if it is received, an ack is immediately transmitted back.

Figure 19. LDC in RX with auto-ack



### 8.2.2 Sniff mode

The sniff timer can be enabled, setting the register FAST\_CS\_TERM\_EN, allowing sensing operation during periodic reception cycles. In this way, the receiver stays in RX for a time defined by the sniff timer (very short time). Once a valid carrier sense event is detected (carrier sense above a programmable RSSI threshold) the RX timer is enabled. Typical scenario is an asynchronous low duty cycle mode where the receiver has to “sniff” the carrier (the preamble sequence) and in case receive the packet. The sniff timer allows a very low duty cycle enabling an ultra-low power receive mode. The sniff timer frequency can be calculated according the following equation.

#### Sniff timer equation

$$f_{sniff} = \frac{f_{dig}}{(24 \cdot 2^{\wedge}CHFLT\_E)} \quad (18)$$

This frequency is higher with a higher value of the channel filter exponent. The rationale behind this is that the RSSI settling time is as lower as higher is the channel filter bandwidth.

The expiration value of the sniff timer is programmed though the RSSI\_SETTLING\_LIMIT register. The timer is expected to be programmed to expire before PQI/SQI detection.

When the sniff timer is enabled, the main controller monitors the settling of the RSSI. Once this is valid, the main controller checks for the CS valid signal:

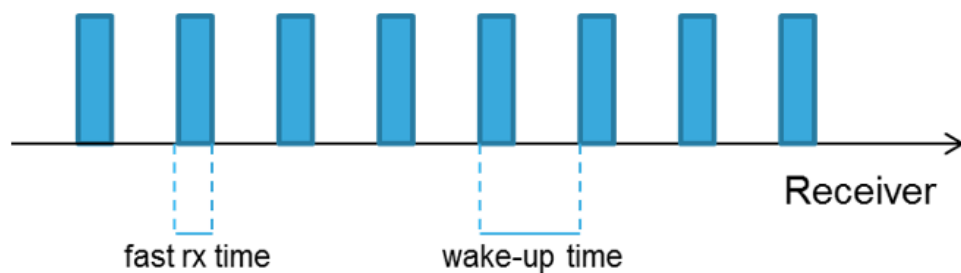
- If the CS valid is low, then the RX is aborted immediately.
- If the CS valid is high, then the RX continues and the main controller starts the CS/PQI/SQI timeout mechanism programmed.

The typical application scenario of the feature described above is the asynchronous LDC.

More specifically, if receiver and transmitter are not synchronized, then the receiver has to 'sniff' about the presence of a carrier during most of the wake-up time slot (inside the preamble transmission) and, in case of carrier level above the programmed threshold (CS valid), to wait for the SYNC word after the preamble.

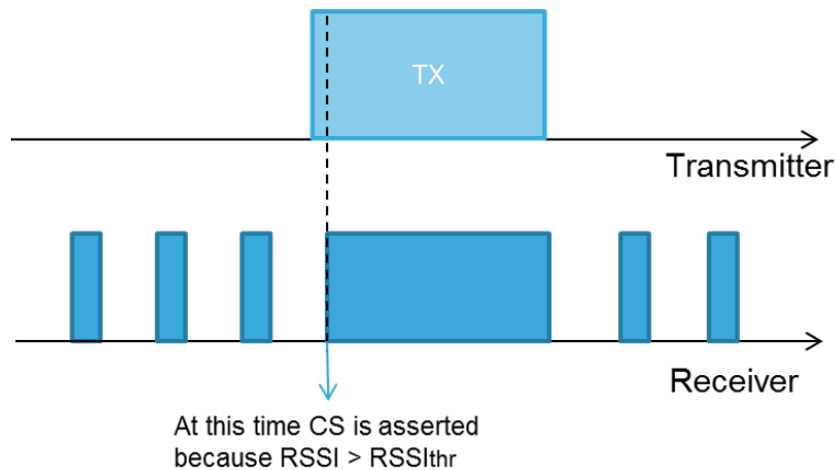
If the carrier is not present, the receiver should go back to sleep as soon as possible without waiting furthermore, in order to save on average current consumption.

Figure 20. Fast RX termination mode with LDC



If the carrier is present, it is possible to receive the entire frame because the RX timeout stop condition is switched to the normal mechanism of PQI/SQI and SYNC can be detected:

Figure 21. Fast Rx termination: CS detection



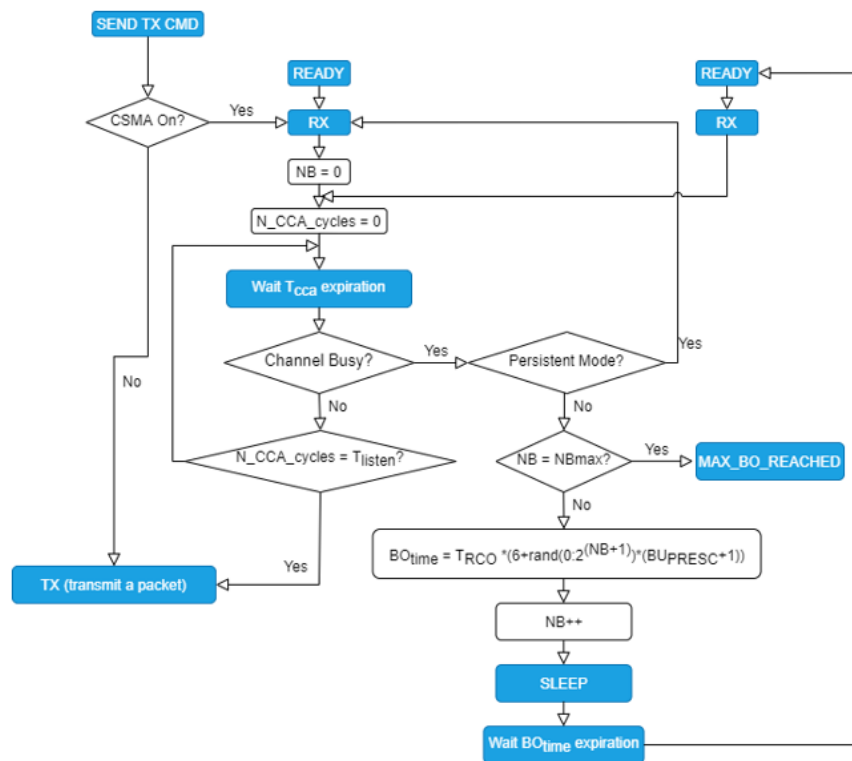
In order to ensure that TX frame is always captured, it is advisable to set wake-up time to less than the preamble time.

### 8.3 CSMA/CA engine

The CSMA/CA engine is a channel access mechanism based on the rule of sensing the channel before transmitting (listen before talk). This avoids the simultaneous use of the channel by different transmitters and increases the probability of correct reception of data being transmitted. This is done by a comparison of the RSSI sensed with the programmable threshold. If the channel is busy, a back-off procedure may be activated to repeat the process a certain number of times, until the channel is found to be idle. When the limit is reached, an interrupt notifies that the channel has been repeatedly found busy and so the transmission has not been performed. While in back-off, the S2-LP stays in SLEEP state in order to reduce power consumption. CCA may optionally be persistent continuing until the channel becomes idle or until the MCU stops it. The thinking behind using this option is to give the MCU the possibility of managing the CCA by itself, for instance, with the allocation of a transmission timer: this timer would start when MCU finishes sending out data to be transmitted, and would end when MCU expects that its transmission take place, which would occur after a period of CCA.

The overall CSMA/CA flowchart is shown in Figure 22. Flowchart of the S2-LP CSMA procedure, where  $T_{cca}$  and  $T_{listen}$  are two of the parameters controlling the clear channel assessment procedure. Design practice recommends that these parameters average the channel energy over a certain period expressed as a multiple of the bit period ( $T_{cca}$ ) and repeat such measurement several times covering longer periods ( $T_{listen}$ ). The measurement is performed directly by checking the carrier sense (CS) generated by the receiver module.

Figure 22. Flowchart of the S2-LP CSMA procedure



To avoid any wait synchronization between different channel contenders, which may cause successive failing CCA operations, the back-off wait time is calculated randomly inside a contention window. The back-off time BO is expressed as a multiple of back-off time units (BU). The contention window is calculated on the basis of the binary exponential back-off (BEB) technique, which doubles the size of the window at each back-off retry (stored in the NB counter):

$$BO_{time} = T_{RCO} * (6 + \text{rand}(0 : 2^{(NB+1)})) * (BU_{PRESC} + 1) \quad (19)$$

During this time, the S2-LP is kept in the SLEEP state. If this CSMA mode is used, the user must set the SLEEP\_MODE\_SEL bit to 1 in order to guarantee the FIFO retention during the SLEEP phase.

The CSMA procedure is controlled by the following parameters:

**CSMA\_ON**: enable/disable the CSMA procedure, this bit is checked at each packet transmission.

**CSMA\_PERS\_ON**: makes the carrier sense persistent that means the channel is continuously monitored until it becomes free again, skipping the back-off waiting steps. The MCU can stop the procedure with a SABORT command.

**CCA\_PERIOD**: code that programs the  $T_{cca}$  time (expressed as multiple of  $T_{bit}$  samples) between two successive CS samplings, as follows:

- 00b:  $64 \times T_{bit}$
- 01b:  $128 \times T_{bit}$
- 10b:  $256 \times T_{bit}$
- 11b:  $512 \times T_{bit}$ .

**NUM\_OF\_CCA\_PERIOD**: configuration of  $T_{listen} = [1..15] \times T_{cca}$ .

**SEED\_RELOAD**: enable/disable the reload of the seed used by the back-off random generator at the start of each CSMA procedure (at the time when the counter is reset, for example  $NB=0$ ). If this functionality is not enabled, the seed is automatically generated and updated by the generator circuit itself.

**BU\_COUNTER\_SEED\_MSB/LSByte**: these bytes are used to set the seed of the pseudo-random number generator when the CSMA cycle starts, if the SEED\_RELOAD bit is enabled. Value 0 is not allowed, because the pseudo-random generator is not working in that case.

**BU\_PRESCALER**: PRESCALER which is used to configure the back-off time unit  $BU=BU\_PRESCALER$ .

$BU\_PRESCALER$  value equal to 0 is not allowed.

**NBACKOFF\_MAX**: max. number of back-off cycles.

Below the timelines of the main cases of transmission with CSMA.

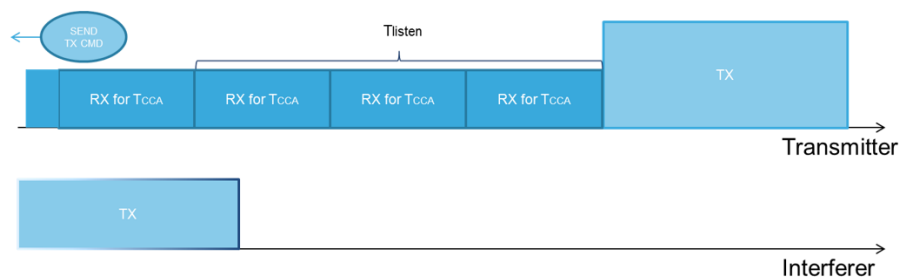
If the channel is free, regardless the value of the persistent\_mode bit, the device must assert channel free for a number of **NUM\_OF\_CCA\_PERIOD** ( $T_{listen}$ ) before transmitting:

Figure 23. CSMA if channel is free (timeline)



If the channel is busy and persistent\_mode bit is 1, the device checks the channel continuously in  $T_{cca}$  periods. When the channel becomes free, it must assert channel free for a number of **NUM\_OF\_CCA\_PERIOD** ( $T_{listen}$ ) before transmitting:

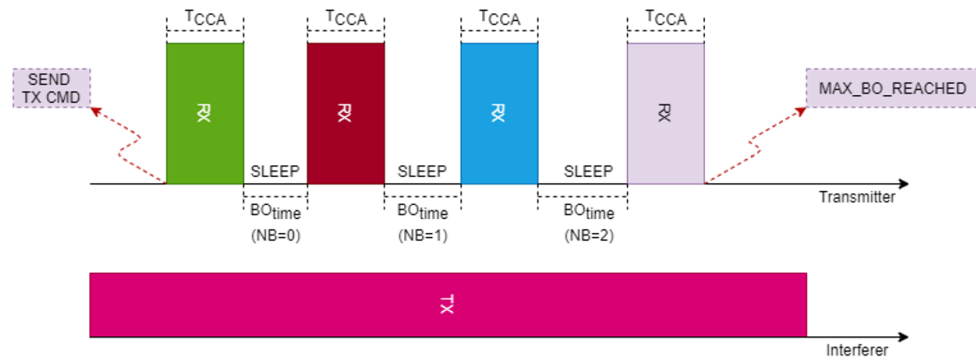
Figure 24. CSMA with persistent mode if channel is busy (timeline)



If the channel is busy and persistent\_mode bit is 0, the device will check the channel for the  $T_{cca}$  period. At the end, being the CS (carrier sense) signal high, it will switch in SLEEP for a randomic time that can last  $BO_{time} = T_{RCO} * (6 + \text{rand}(0 : 2^{(NB+1)}) * (BU_{PRESC} + 1))$  with  $NB=0$

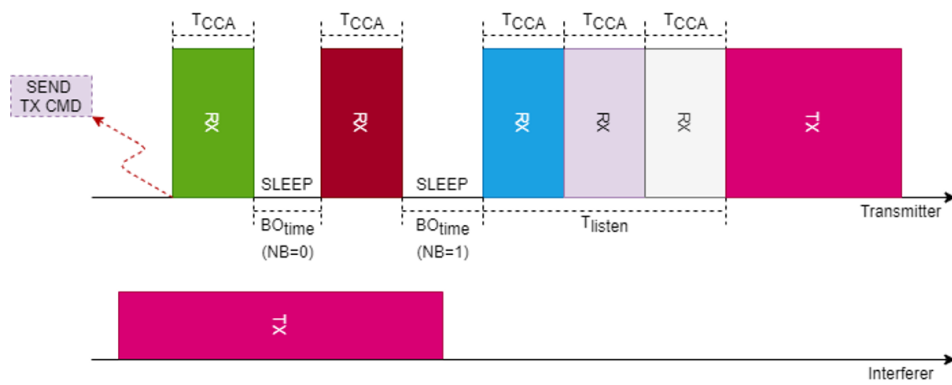
At the end of this period, it will again switch to RX for another  $T_{cca}$ , then sleep and so on until the number of back-off set is reached. At that point, an interrupt MAX\_BO\_REACHED is notified to the MCU:

Figure 25. CSMA with non-persistent mode if channel is busy (timeline)



Finally, if the channel becomes free (for example during one of the SLEEP times), the device must assert channel free for a number of **NUM\_OF\_CCA\_PERIOD** ( $T_{listen}$ ) before transmitting:

Figure 26. CSMA with non-persistent mode if channel becomes free (timeline)



Note: *in CSMA/CA mode it is not possible to go to RX state to receive packets: only carrier sensing is performed. To be able to receive an ACK packet it is necessary to deactivate the CSMA mode before switching to RX state.*

## 9 MCU interface

Communication with the MCU goes through a standard 4-wire SPI interface and 4 GPIOs (plus SHUTDOWN pin). MCU can performs the following operations:

- Program the S2-LP in different operating modes by sending commands
- Read data from the RX FIFO and write data into the TX FIFO
- Configure the S2-LP through the registers
- Retrieve information from the S2-LP
- Get interrupt requests and signals from the GPIO pins
- Apply external signals to the GPIO pins
- Put the S2-LP in SHUTDOWN state or exit from SHUTDOWN state

### 9.1 Serial peripheral interface

The four-wire SPI interface consist of:

- **SCLK**: the SPI clock from MCU to the S2-LP
- **MOSI**: data from MCU to the S2-LP
- **MISO**: data from the S2-LP to MCU
- **CSn**: chip select signal, active low.

As the MCU is the master, it always drives the CSn and SCLK. According to the active SCLK polarity and phase, the S2-LP SPI can be classified as mode 0 (CPOL=0, CPHA=0), which means that the base value of SCLK is zero, data are read on the clock rising edge and data are changed on the clock falling edge. The MISO is in tri-state mode when CSn is high. All transfers are MSB first.

The interface allows the following operations:

- Write data (to registers or TX FIFO)
- Read data (from registers or RX FIFO)
- Send commands.

The SPI communication is supported in all the active states, and also during the low power state: STANDBY and SLEEP.

When accessing the SPI interface, the two status bytes of the MC\_STATE (MC\_STATE[1], MC\_STATE[0]) registers are sent to the MISO pin.

Figure 27. SPI write sequence

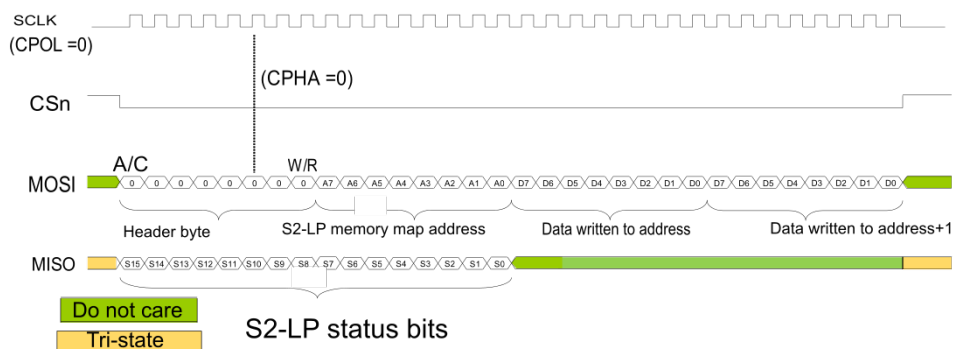


Figure 28. SPI read sequence

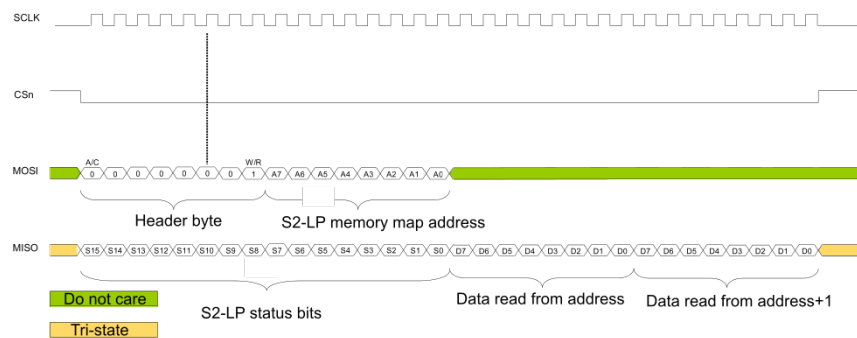
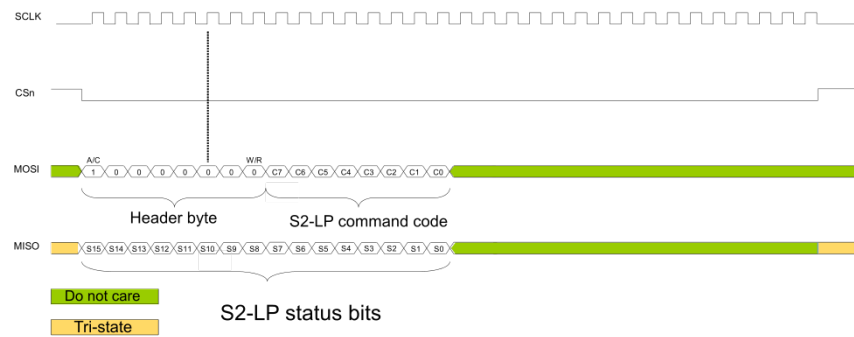


Figure 29. SPI command sequence



Concerning the first byte, the MSB is an A/C bit (address/commands: 0 indicates that the following byte is an address, 1 indicates that the following byte is a command code), while the LSB is a W/R bit (write/read: 1 indicates a read operation). All other bits must be zero.

Read and write operations are persistently executed while CSn is kept active (low), the address is automatically incremented (burst mode).

Accessing the FIFO is done as usual with the read and write commands, by putting, as address, the code 0xFF. Burst mode is available to access the sequence of bytes in the FIFO. Clearly, RX-FIFO is accessed with a read operation, TX-FIFO with a write operation.

## 9.2 Interrupts

In order to notify the MCU of a certain number of events an interrupt signal is generated on a selectable GPIO. The following events trigger an interrupt to the MCU:

Table 59. Interrupts list

Bit	Events group	Interrupt event
0	Packet oriented	RX data ready
1		RX data discarded (upon filtering)
2		TX data sent
3		Max. re-TX reached
4		CRC error
5		TX FIFO underflow/overflow error
6		RX FIFO underflow/overflow error
7		TX FIFO almost full

Bit	Events group	Interrupt event
8	Packet oriented	TX FIFO almost empty
9		RX FIFO almost full
10		RX FIFO almost empty
11		Max. number of back-off during CCA
12	Signal quality related	Valid preamble detected
13		Sync word detected
14		RSSI above threshold (CS)
15	Device status related	Wake-up timeout in LDCR mode <sup>(1)</sup>
16		READY <sup>(2)</sup>
17		STANDBY state switching in progress
18		Low battery level
19		Power-on reset
28	Timer related	RX timer timeout
29		Sniff timer timeout

1. The interrupt flag n.15 is set (and consequently the interrupt request) only when the XO clock is available for the state machine. This time may be delayed compared to the actual timer expiration. However, the real time event can be sensed putting the end-of-counting signal on a GPIO output.
2. The interrupt flag n.16 is set each time the S2-LP goes to READY state and the XO has completed its setting transient (XO ready condition detected).

All interrupts are reported on a set of interrupt status registers and are individually maskable. The interrupt status register must be cleared upon a read event from the MCU.

The status of all the interrupts are reported in the IRQ\_STATUS register: bits are high for the events that have generated any interrupts. The interrupts are individually maskable using the IRQ\_MASK registers: if the mask bit related to a particular event is programmed at 0, that event does not generate any interrupt request.

**Table 60. IRQ type S2-LP state**

IRQ Type	Status of S2-LP
IRQ_RX_DATA_READY	READY
IRQ_RX_DATA_DISC	READY
IRQ_TX_DATA_SENT	READY
IRQ_MAX_RE_TX_REACH	READY
IRQ_CRC_ERROR	READY
IRQ_TX_FIFO_ERROR	TX or READY
IRQ_RX_FIFO_ERROR	RX or READY
IRQ_TX_FIFO_ALMOST_FULL	TX or READY
IRQ_TX_FIFO_ALMOST_EMPTY	TX
IRQ_RX_FIFO_ALMOST_FULL	RX
IRQ_RX_FIFO_ALMOST_EMPTY	RX or READY
IRQ_MAX_BO_CCA_REACH	READY
IRQ_VALID_PREAMBLE	RX
IRQ_VALID_SYNC	RX
IRQ_RSSI_ABOVE_TH	RX
IRQ_WKUP_TOUT_LDC	READY/TX/RX

IRQ Type	Status of S2-LP
IRQ_READY	READY
IRQ_STANDBY_DELAYED	STANDBY
IRQ_LOW_BATT_LVL	ANY
IRQ_POR	READY
IRQ_BOR	ANY
IRQ_LOCK	READY
IRQ_VCO_CALIBRATION_END	READY
IRQ_PA_CALIBRATION_END	READY
IRQ_RX_TIMEOUT	READY
IRQ_RX_SNIFF_TIMEOUT	READY

### 9.3 GPIOs

The four GPIOs can be configured as follows:

**Table 61. GPIO digital output functions**

I/O selection	Output signal
0	nIRQ (interrupt request, active low)
1	POR inverted (active low)
2	Wake-up timer expiration: '1' when WUT has expired
3	Low battery detection: '1' when battery is below threshold setting
4	TX data internal clock output (TX data are sampled on the rising edge of it)
5	TX state outputs a command information coming from the RADIO_TX block
6	TX/RX FIFO almost empty flag
7	TX/RX FIFO almost full flag
8	RX data output
9	RX clock output (recovered from received data)
10	RX state indication: '1' when the S2-LP is transiting in the RX state
11	Device in a state other than SLEEP or STANDBY: '0' when in SLEEP/STANDBY
12	Device in STANDBY state
13	Antenna switch signal used for antenna diversity
14	Valid preamble detected flag
15	Sync word detected flag
16	RSSI above threshold (same indication of CS register)
17	Reserved
18	TX or RX mode indicator (to enable an external range extender)
19	VDD (to emulate an additional GPIO of the MCU, programmable by SPI)
20	GND (to emulate an additional GPIO of the MCU, programmable by SPI)
21	External SMPS enable signal (active high)
22	Device in SLEEP state
23	Device in READY state
24	Device in LOCK state

I/O selection	Output signal
25	Device waiting for a high level of the lock-detector output signal
26	TX_DATA_OOK signal (internal control signal generated in the OOK analog smooth mode)
27	Device waiting for a high level of the READY2 signal from XO
28	Device waiting for timer expiration to allow PM block settling
29	Device waiting for end of VCO calibration
30	Device enables the full circuitry of the SYNTH block
31	Reserved

**Table 62. GPIO digital input functions**

I/O selection	Input signal
0	1 >> TX command
1	1 >> RX command
2	TX data input for direct modulation
3	Wake-up from external input (sensor output)
4	External clock @ 34.7 kHz (used for LDC modes timing)
From 5 to 31	Not used

## 10 Register contents

**Table 63. Register contents**

Name	Addr	Default	Bit	Field name	Description
GPIO0_CONF	00	0A	7:3	GPIO_SELECT	Specify the GPIO0 I/O signal, default setting POR (see <a href="#">Table 61</a> . <a href="#">Table 57</a> ).
			2	RESERVED	-
			1:0	GPIO_MODE	GPIO0 Mode: <ul style="list-style-type: none"> <li>• 00b: Analog (Hi-Z)</li> <li>• 01b: Digital input</li> <li>• 10b: Digital output low power</li> <li>• 11b: Digital output high power</li> </ul>
GPIO1_CONF	01	A2	7:3	GPIO_SELECT	Specify the GPIO1 I/O signal, default setting digital GND (see <a href="#">Table 61</a> . <a href="#">Table 57</a> ).
			2	RESERVED	-
			1:0	GPIO_MODE	GPIO1 mode: <ul style="list-style-type: none"> <li>• 00b: Analog (Hi-Z)</li> <li>• 01b: Digital input1</li> <li>• 10b: Digital output low power</li> <li>• 11b: Digital Output High Power</li> </ul>
GPIO2_CONF	02	A2	7:3	GPIO_SELECT	Specify the GPIO2 I/O signal, default setting digital GND (see <a href="#">Table 61</a> . <a href="#">Table 57</a> ).
			2	RESERVED	-
			1:0	GPIO_MODE	GPIO2 mode: <ul style="list-style-type: none"> <li>• 00b: Analog (Hi-Z)</li> <li>• 01b: Digital input</li> <li>• 10b: Digital output low power</li> <li>• 11b: Digital output high power</li> </ul>
GPIO3_CONF	03	A2	7:3	GPIO_SELECT	Specify the GPIO3 I/O signal, default setting digital GND (see <a href="#">Table 61</a> . <a href="#">Table 57</a> ).
			2	RESERVED	-
			1:0	GPIO_MODE	GPIO3 mode: <ul style="list-style-type: none"> <li>• 00b: Analog (Hi-Z)</li> <li>• 00b: Analog</li> <li>• 01b: Digital Input</li> <li>• 10b: Digital Output Low Power</li> <li>• 11b: Digital Output High Power</li> </ul>
SYNT3	05	42	7:5	PLL_CP_ISEL	Set the charge pump current according to the XTAL frequency (see <a href="#">Table 37</a> . <a href="#">Table 34</a> ).
			4	BS	Synthesizer band select. This parameter selects the out-of loop divide factor of the synthesizer: <ul style="list-style-type: none"> <li>• 0: 4, band select factor for high band</li> <li>• 1: 8, band select factor for middle band (see <a href="#">Section 5.3.1: RF channel frequency settings</a>).</li> </ul>
			3:0	SYNT[27:24]	MSB bits of the PLL programmable divider (see <a href="#">Section 5.3.1: RF channel frequency settings</a> ).
SYNT2	06	16	7:0	SYNT[23:16]	Intermediate bits of the PLL programmable divider (see <a href="#">Section 5.3.1: RF channel frequency settings</a> ).
SYNT1	07	27	7:0	SYNT[15:8]	Intermediate bits of the PLL programmable divider (see <a href="#">Section 5.3.1: RF channel frequency settings</a> ).
SYNT0	08	62	7:0	SYNT[7:0]	LSB bits of the PLL programmable divider (see <a href="#">Section 5.3.1: RF channel frequency settings</a> ).

Name	Addr	Default	Bit	Field name	Description
<b>IF_OFFSET_ANA</b>	09	2A	7:0	IF_OFFSET_ANA	Intermediate frequency setting for the analog RF synthesizer, default: 300 kHz, see Eq. (15).
<b>IF_OFFSET_DIG</b>	0A	B8	7:0	IF_OFFSET_DIG	Intermediate frequency setting for the digital shift-to-baseband circuits, default: 300 kHz, see Eq. (15).
<b>CHSPACE</b>	0C	3F	7:0	CH_SPACE	Channel spacing setting, see Eq. (16).
<b>CHNUM</b>	0D	00	7:0	CH_NUM	Channel number. This value is multiplied by the channel spacing and added to the synthesizer base frequency to generate the actual RF carrier frequency, see Eq. (16).
<b>MOD4</b>	0E	83	7:0	DATARATE_M[15:8]	The MSB of the mantissa value of the data rate equation, see Eq. (14).
<b>MOD3</b>	0F	2B	7:0	DATARATE_M[7:0]	The LSB of the mantissa value of the data rate equation, see Eq. (14).
<b>MOD2</b>	10	77	7:4	MOD_TYPE	Modulation type: <ul style="list-style-type: none"> <li>• 0: 2-FSK</li> <li>• 1: 4-FSK</li> <li>• 2: 2-GFSK BT=1</li> <li>• 3: 4-GFSK BT=1</li> <li>• 5: ASK/OOK</li> <li>• 7: unmodulated</li> <li>• 10: 2-GFSK BT=0.5</li> <li>• 11: 4-GFSK BT=0.5</li> </ul>
			3:0	DATARATE_E	The exponent value of the data rate equation (see Eq. (14)).
<b>MOD1</b>	11	03	7	PA_INTERP_EN	1: enable the PA power interpolator (see Section 5.6.1: PA configuration).
			6	MOD_INTERP_EN	1: enable frequency interpolator for the GFSK shaping (see Section 5.4.1.1: Gaussian shaping).
			5:4	CONST_MAP	Select the constellation map for 4-(G)FSK or 2-(G)FSK modulations (see Table 41. Constellation mapping 2-(G)FSK and Table 42. Constellation mapping 4-(G)FSK).
			3:0	FDEV_E	The exponent value of the frequency deviation equation (see Eq. (10)).
<b>MOD0</b>	12	93	7:0	FDEV_M	The mantissa value of the frequency deviation equation (see Eq. (10)).
<b>CHFLT</b>	13	23	7:4	CHFLT_M	The mantissa value of the receiver channel filter (see Table 44. Channel filter words).
			3:0	CHFLT_E	The exponent value of the receiver channel filter (see Table 44. Channel filter words).
<b>AFC2</b>	14	C8	7	AFC_FREEZE_ON_SYNC	1: enable the freeze AFC correction upon sync word detection.
			6	AFC_ENABLED	1: enable the AFC correction.
			5	AFC_MODE	Select AFC mode: 0: AFC loop closed on slicer 1: AFC loop closed on second conversion stage.
			4:0	RESERVED	-
<b>AFC1</b>	15	18	7:0	AFC_FAST_PERIOD	The length of the AFC fast period.
<b>AFC0</b>	16	25	7:4	AFC_FAST_GAIN	The AFC loop gain in fast mode (2's log).
			3:0	AFC_SLOW_GAIN	The AFC loop gain in slow mode (2's log).
<b>RSSI_FLT</b>	17	E3	7:4	RSSI_FLT	Gain of the RSSI filter.
			3:2	CS_MODE	Carrier sense mode: <ul style="list-style-type: none"> <li>• 00b: Static CS</li> <li>• 01b: Dynamic CS with 6dB dynamic threshold</li> </ul>

Name	Addr	Default	Bit	Field name	Description
RSSI_FLT	17	E3			<ul style="list-style-type: none"> <li>10b: Dynamic CS with 12dB dynamic threshold</li> <li>11b: Dynamic CS with 18dB dynamic threshold.</li> </ul> (see Section 5.5.8.2: Carrier sense)
			1:0	RESERVED	-
RSSI_TH	18	28	7:0	RSSI_TH	Signal detect threshold in 1 dB steps. The RSSI_TH can be converted in dBm using the formula RSSI_TH-146.
AGCCTRL4	1A	54	7:4	LOW_THRESHOLD_0	Low threshold 0 for the AGC
			3:0	LOW_THRESHOLD_1	Low threshold 1 for the AGC
AGCCTRL3	1B	10	7:0	LOW_THRESHOLD_SEL	Low threshold selection (defined in the AGCCTRL4). Bitmask for each attenuation step.
AGCCTRL2	1C	22	7:6	RESERVED	-
			5	FREEZE_ON_SYNC	Enable the AGC algorithm to be frozen on SYNC
			4	RESERVED	-
			3:0	MEAS_TIME	AGC measurement time
AGCCTRL1	1D	59	7:4	HIGH_THRESHOLD	High threshold for the AGC
			3:0	RESERVED	-
AGCCTRL0	1E	8C	7	AGC_ENABLE	0: disabled 1: enabled
			6	RESERVED	-
			5:0	HOLD_TIME	Hold time for after gain adjustment for the AGC.
ANT_SELECT_CONF	1F	45	7	RESERVED	-
			6:5	EQU_CTRL	ISI cancellation equalizer: <ul style="list-style-type: none"> <li>00b: equalization disabled</li> <li>01b: single pass equalization</li> <li>10b: dual pass equalization.</li> </ul> (see Section 5.4.1.2: ISI cancellation 4-(G)FSK)
			4	CS_BLANKING	Do not fill the RX FIFO with data if the CS is threshold (see Section 5.5.9: CS blanking).
			3	AS_ENABLE	1: enable the antenna switching (see Section 5.5.10: Antenna switching).
			2:0	AS_MEAS_TIME	Set the measurement time.
CLOCKREC2	20	C0	7:5	CLK_REC_P_GAIN_SLOW	Clock recovery slow loop gain (log2).
			4	CLK_REC_ALGO_SEL	Select the symbol timing recovery algorithm: <ul style="list-style-type: none"> <li>0: DLL</li> <li>1: PLL.</li> </ul>
			3:0	CLK_REC_I_GAIN_SLOW	Set the integral slow gain for symbol timing recovery (PLL mode only).
CLOCKREC1	21	58	7:5	CLK_REC_P_GAIN_FAST	Clock recovery fast loop gain (log2).
			4	PSTFLT_LEN	Select the post filter length: <ul style="list-style-type: none"> <li>0: 8 symbols</li> <li>1: 16 symbols.</li> </ul>
			3:0	CLK_REC_I_GAIN_FAST	Set the integral fast gain for symbol timing recovery (PLL mode only).
PCKTCTRL6	2B	80	7:2	SYNC_LEN	The number of bits used for the SYNC field in the packet.
			1:0	PREAMBLE_LEN[9:8]	The MSB of the number of '01' or '10' of the preamble of the packet.
PCKTCTRL5	2C	10	7:0	PREAMBLE_LEN[7:0]	The LSB of the number of '01' or '10' of the preamble of the packet.

Name	Addr	Default	Bit	Field name	Description
<b>PCKTCTRL4</b>	2D	00	7	LEN_WID	The number of bytes used for the length field: <ul style="list-style-type: none"> <li>0: 1 byte</li> <li>1: 2 bytes.</li> </ul>
			6:4	RESERVED	-
			3	ADDRESS_LEN	1: include the ADDRESS field in the packet.
			2:0	RESERVED	-
<b>PCKTCTRL3</b>	2E	20	7:6	PCKT_FRMT	Format of packet: <ul style="list-style-type: none"> <li>0: Basic</li> <li>1: 802.15.4g</li> <li>2: UART OTA</li> <li>3: Stack</li> </ul> (see Section 7: Packet handler engine )
			5:4	RX_MODE	RX mode: <ul style="list-style-type: none"> <li>0: normal mode</li> <li>1: direct through FIFO</li> <li>2: direct through GPIO</li> </ul>
			3	FSK4_SYM_SWAP	Select the symbol mapping for 4(G)FSK.
			2	BYTE_SWAP	Select the transmission order between MSB and LSB.
			1:0	PREAMBLE_SEL	Select the preamble pattern.
<b>PCKTCTRL2</b>	2F	00	7:6	RESERVED	-
			5	FCS_TYPE_4G	This is the FCS type in header field of 802.15.4g packet.
			4	FEC_TYPE_4G/STOP_BIT	<ul style="list-style-type: none"> <li>If the 802.15.4 mode is enabled, this is the FCS type in header field of 802.15.4g packet. Select the FEC type of 802.15.4g packet:               <ul style="list-style-type: none"> <li>0: NRNSC</li> <li>1: RSC.</li> </ul> </li> <li>If the UART packet is enabled, this is the value of the STOP_BIT.</li> </ul>
			3	INT_EN_4G/START_BIT	<ul style="list-style-type: none"> <li>If the 802.15.4 mode is enabled, 1: enable the interleaving of 802.15.4g packet.</li> <li>If the UART packet is enabled, this is the value of the START_BIT.</li> </ul>
			2	MBUS_3OF6_EN	1: enable the 3-out-of-6 encoding/decoding.
			1	MANCHESTER_EN	1: enable the Manchester encoding/decoding.
			0	FIX_VAR_LEN	Packet length mode: <ul style="list-style-type: none"> <li>0: fixed</li> <li>1: variable (in variable mode the field LEN_WID of PCKTCTRL3 register must be configured)</li> </ul>
<b>PCKTCTRL1</b>	30	2C	7:5	CRC_MODE	CRC field: <ul style="list-style-type: none"> <li>0: no CRC field</li> <li>1: CRC using poly 0x07</li> <li>2: CRC using poly 0x8005</li> <li>3: CRC using poly 0x1021</li> <li>4: CRC using poly 0x864CBF</li> <li>5: CRC using poly</li> </ul>
			4	WHIT_EN	1: enable the whitening mode.
			3:2	TXSOURCE	Tx source data: <ul style="list-style-type: none"> <li>0: normal mode</li> <li>1: direct through FIFO</li> <li>2: direct through GPIO</li> <li>3: PN9</li> </ul>

Name	Addr	Default	Bit	Field name	Description
<b>PCKTCTRL1</b>	30	2C	1	SECOND_SYNC_SEL	In TX mode: <ul style="list-style-type: none"> <li>0 select the primary SYNC word</li> <li>1 select the secondary SYNC word.</li> </ul> In RX mode, if 1 enable the dual SYNC word detection mode.
			0	FEC_EN	1: enable the FEC encoding in TX or the Viterbi decoding in RX.
<b>PCKTLEN1</b>	31	00	7:0	PCKTLEN1	MSB of length of packet in bytes.
<b>PCKTLEN0</b>	32	14	7:0	PCKTLEN0	LSB of length of packet in bytes.
<b>SYNC3</b>	33	88	7:0	SYNC3	SYNC word byte 3.
<b>SYNC2</b>	34	88	7:0	SYNC2	SYNC word byte 2.
<b>SYNC1</b>	35	88	7:0	SYNC1	SYNC word byte 1.
<b>SYNC0</b>	36	88	7:0	SYNC0	SYNC word byte 0.
<b>QI</b>	37	01	7:5	SQI_TH	SQI threshold.
			4:1	PQI_TH	PQI threshold.
			0	SQI_EN	1: enable the SQI check.
<b>PCKT_PSTMBL</b>	38	00	7:0	PCKT_PSTMBL	Set the packet postamble length.
<b>PROTOCOL2</b>	39	40	7	CS_TIMEOUT_MASK	1: enable the CS value contributes to timeout disabling.
			6	SQI_TIMEOUT_MASK	1: enable the SQI value contributes to timeout disabling.
			5	PQI_TIMEOUT_MASK	1: enable the PQI value contributes to timeout disabling.
			4:3	TX_SEQ_NUM_RELOAD	TX sequence number to be used when counting reset is required using the related command.
			2	FIFO_GPIO_OUT_MUX_SEL	0: select the almost empty/full control for TX FIFO. 1: select the almost empty/full control for RX FIFO.
			1:0	LDC_TIMER_MULT	Set the LDC timer multiplier factor: <ul style="list-style-type: none"> <li>00b: x1</li> <li>01b: x2</li> <li>10b: x4</li> <li>11b: x8.</li> </ul>
<b>PROTOCOL1</b>	3A	00	7	LDC_MODE	1: enable the Low Duty Cycle mode.
			6	LDC_RELOAD_ON_SYNC	1: enable the LDC timer reload mode.
			5	PIGGYBACKING	1: enable the piggybacking.
			4	FAST_CS_TERM_EN	1: enable the RX sniff timer.
			3	SEED_RELOAD	1: enable the reload of the back-off random generator seed using the value written in the BU_COUNTER_SEED.
			2	CSMA_ON	1: enable the CSMA channel access mode.
			1	CSMA_PERS_ON	1: enable the CSMA persistent mode (no back-off cycles).
			0	AUTO_PCKT_FLT	1: enable the automatic packet filtering control.
<b>PROTOCOL0</b>	3B	08	7:4	NMAX_RETX	Max. number of re-TX (from 0 to 15)(0: re-transmission is not performed).
			3	NACK_TX	1: field NO_ACK=1 on transmitted packet.
			2	AUTO_ACK	1: enable the automatic acknowledgment if packet received request.
			1	PERS_RX	1: enable the persistent RX mode.
			0	RESERVED	-
<b>FIFO_CONFIG3</b>	3C	30	7	RESERVED	-
			6:0	RX_AFTHR	Set the RX FIFO almost full threshold.

Name	Addr	Default	Bit	Field name	Description
FIFO_CONFIG2	3D	30	7	RESERVED	-
			6:0	RX_AETHR	Set the RX FIFO almost empty threshold.
FIFO_CONFIG1	3E	30	7	RESERVED	-
			6:0	TX_AFTHR	Set the TX FIFO almost full threshold.
FIFO_CONFIG0	3F	30	7	RESERVED	-
			6:0	TX_AETHR	Set the TX FIFO almost empty threshold.
PKT_FLT_OPTIONS	40	40	7	RESERVED	-
			6	RX_TIMEOUT_AND_OR_SEL	Logical Boolean function applied to CS/SQI/PQI values: 1: OR, 0: AND.
			5	RESERVED	-
			4	SOURCE_ADDR_FLT	1: RX packet accepted if its source field matches with RX_SOURCE_ADDR register
			3	DEST_VS_BROADCAST_ADDR	1: RX packet accepted if its source field matches with BROADCAST_ADDR register.
			2	DEST_VS_MULTICAST_ADDR	1: RX packet accepted if its destination address matches with MULTICAST_ADDR register.
			1	DEST_VS_SOURCE_ADDR	1: RX packet accepted if its destination address matches with RX_SOURCE_ADDR register.
0	CRC_FLT	1: packet discarded if CRC is not valid.			
PKT_FLT_GOALS4	41	00	7:0	RX_SOURCE_MASK	Mask register for source address filtering.
PKT_FLT_GOALS3	42	00	7:0	RX_SOURCE_ADDR/DUAL_SYNC3	If dual sync mode enabled: dual SYNC word byte 3, Otherwise RX packet source or TX packet destination field.
PKT_FLT_GOALS2	43	00	7:0	BROADCAST_ADDR/DUAL_SYNC2	If dual sync mode enabled: dual SYNC word byte 2, Broadcast address.
PKT_FLT_GOALS1	44	00	7:0	MULTICAST_ADDR/DUAL_SYNC1	If dual sync mode enabled: dual SYNC word byte 1, Multicast address.
PKT_FLT_GOALS0	45	00	7:0	TX_SOURCE_ADDR/DUAL_SYNC0	If dual sync mode enabled: dual SYNC word byte 0, Tx packet source or RX packet destination field.
TIMERS5	46	01	7:0	RX_TIMER_CNTR	Counter for RX timer.
TIMERS4	47	00	7:0	RX_TIMER_PRESC	Prescaler for RX timer.
TIMERS3	48	01	7:0	LDC_TIMER_PRESC	Prescaler for wake up timer.
TIMERS2	49	00	7:0	LDC_TIMER_CNTR	Counter for wake up timer.
TIMERS1	4A	01	7:0	LDC_RELOAD_PRSC	Prescaler value for reload operation of wake up timer.
TIMERS0	4B	00	7:0	LDC_RELOAD_CNTR	Counter value for reload operation of wake up timer.
CSMA_CONF3	4C	4C	7:0	BU_CNTR_SEED[14:8]	MSB part of the seed for the random generator used to apply the CSMA algorithm.
CSMA_CONF2	4D	00	7:0	BU_CNTR_SEED[7:0]	LSB part of the seed for the random generator used to apply the CSMA algorithm.
CSMA_CONF1	4E	04	7:2	BU_PRSC	Prescaler value for the back-off unit BU.
			1:0	CCA_PERIOD	Multiplier for the Tcca timer.
CSMA_CONF0	4F	00	7:4	CCA_LEN	The number of time in which the listen operation is performed.
			3	RESERVED	-
			2:0	NBACKOFF_MAX	Max number of back-off cycles.
IRQ_MASK3	50	00	7:0	INT_MASK[31:24]	Enable the routing of the interrupt flag on the configured IRQ GPIO.

Name	Addr	Default	Bit	Field name	Description
IRQ_MASK2	51	00	7:0	INT_MASK[23:16]	Enable the routing of the interrupt flag on the configured IRQ GPIO.
IRQ_MASK1	52	00	7:0	INT_MASK[15:8]	Enable the routing of the interrupt flag on the configured IRQ GPIO.
IRQ_MASK0	53	00	7:0	INT_MASK[7:0]	Enable the routing of the interrupt flag on the configured IRQ GPIO.
FAST_RX_TIMER	54	28	7:0	RSSI_SETTLING_LIMIT	Sniff timer configuration.
PA_POWER8	5A	01	7	RESERVED	-
			6:0	PA_LEVEL8	Output power level for 8 <sup>th</sup> slot.
PA_POWER7	5B	0C	7	RESERVED	-
			6:0	PA_LEVEL_7	Output power level for 7 <sup>th</sup> slot.
PA_POWER6	5C	18	7	RESERVED	-
			6:0	PA_LEVEL_6	Output power level for 6 <sup>th</sup> slot.
PA_POWER5	5D	24	7	RESERVED	-
			6:0	PA_LEVEL_5	Output power level for 5 <sup>th</sup> slot.
PA_POWER4	5E	30	7	RESERVED	-
			6:0	PA_LEVEL_4	Output power level for 4 <sup>th</sup> slot.
PA_POWER3	5F	48	7	RESERVED	-
			6:0	PA_LEVEL_3	Output power level for 3 <sup>rd</sup> slot.
PA_POWER2	60	60	7	RESERVED	-
			6:0	PA_LEVEL_2	Output power level for 2 <sup>nd</sup> slot.
PA_POWER1	61	00	7	RESERVED	-
			6:0	PA_LEVEL_1	Output power level for 1 <sup>st</sup> slot.
PA_POWER0	62	47	7	DIG_SMOOTH_EN	1: enable the generation of the internal signal TX_DATA which is the input of the FIR. Needed when FIR_EN=1.
			6	PA_MAXDBM	1: configure the PA to send maximum output power. Power ramping is disable with this bit set to 1.
			5	PA_RAMP_EN	1: enable the power ramping.
			4:3	PA_RAMP_STEP_LEN	Set the step width (unit: 1/8 of bit period).
			2:0	PA_LEVEL_MAX_IDX	Final level for power ramping or selected output power index.
PA_CONFIG1	63	03	7:4	RESERVED	-
			3:2	FIR_CFG	FIR configuration: <ul style="list-style-type: none"> <li>• 00b: filtering</li> <li>• 01b: ramping</li> <li>• 10b: switching (see <a href="#">Section 5.4.2.1: OOK smoothing</a>)</li> </ul>
			1	FIR_EN	1: enable FIR (see <a href="#">Section 5.4.2.1: OOK smoothing</a> )
			0	RESERVED	-
PA_CONFIG0	64	8A	7:4	PA_DEGEN_TRIM	11xx @ code threshold: 485 10xx @ code threshold: 465 01xx @ code threshold: 439 00xx @ code threshold: 418 xx11 @ clamp voltage: 0.55 V xx10 @ clamp voltage: 0.50 V xx01 @ clamp voltage: 0.45 V

Name	Addr	Default	Bit	Field name	Description
PA_CONFIG0	64	8A			xx00 @ clamp voltage: 0.40 V.
			3	PA_DEGEN_ON	Enables the 'degeneration' mode that introduces a pre-distortion to linearize the power control curve.
			2	SAFE_ASK_CAL	During a TX operation, enables and starts the digital ASK calibrator.
			1:0	PA_FC	PA bessell filter bandwidth: <ul style="list-style-type: none"> <li>• 00b: 12.5 kHz (data rate 16.2 kbps)</li> <li>• 01b: 25 kHz (data rate 32 kbps)</li> <li>• 10b: 50 kHz (data rate 62.5 kbps)</li> <li>• 11b: 100 kHz (data rate 125 kbps), (see <a href="#">Section 5.4.2.1: OOK smoothing</a>).</li> </ul>
SYNTH_CONFIG2	65	D0	7:3	RESERVED	-
			2	PLL_PFD_SPLIT_EN	Enables increased DN current pulses to improve linearization of CP/PFD (see <a href="#">Table 37. Charge pump words</a> ).
			1:0	RESERVED	-
VCO_CONFIG	68	03	7:6	RESERVED	-
			5	VCO_CALAMP_EXT_SEL	1 → VCO amplitude calibration is skipped (external amplitude word forced on VCO).
			4	VCO_CALFREQ_EXT_SEL	1 → VCO frequency calibration is skipped (external amplitude word forced on VCO).
			3:0	RESERVED	-
VCO_CALIBR_IN2	69	88	7:0	RESERVED	-
VCO_CALIBR_IN1	6A	40	7:0	RESERVED	-
VCO_CALIBR_IN0	6B	40	7:0	RESERVED	-
XO_RCO_CONF1	6C	45	7:5	RESERVED	-
			4	PD_CLKDIV	1: disable both dividers of digital clock (and reference clock for the SMPS) and IF-ADC clock.
			3:0	RESERVED	-
XO_RCO_CONF0	6D	30	7	EXT_REF	<ul style="list-style-type: none"> <li>• 0: reference signal from XO circuit</li> <li>• 1: reference signal from XIN pin.</li> </ul>
			6:4	GM_CONF	Set the driver gm of the XO at start up.
			3	REFDIV	1: enable the the reference clock divider.
			2	RESERVED	-
			1	EXT_RCO_OSC	1: the 34.7 kHz signal must be supplied from any GPIO.
			0	RCO_CALIBRATION	1: enable the automatic RCO calibration.
RCO_CALIBR_CONF3	6E	70	7:4	RWT_IN	RWT word value for the RCO.
			3:0	RFB_IN[4:1]	MSB part of RFB word value for RCO.
RCO_CALIBR_CONF2	6F	4D	7	RFB_IN[0]	LSB part of RFB word value for RCO.
			6:0	RESERVED	-
PM_CONF4	75	17	7:6	RESERVED	-
			5	EXT_SMPS	1: disable the internal SMPS.
			4:0	RESERVED	-
PM_CONF3	76	20	7	KRM_EN	<ul style="list-style-type: none"> <li>• 0: divider by 4 enabled (SMPS' switching frequency is <math>F_{SW}=F_{dig}/4</math>)</li> <li>• 1: rate multiplier enabled (SMPS' switching frequency is <math>F_{SW}=KRM \cdot F_{dig}/(2^{15})</math>).</li> </ul>

Name	Addr	Default	Bit	Field name	Description
PM_CONF3	76	20	6:0	KRM[14:8]	Sets the divider ratio (MSB) of the rate multiplier (default: Fsw=Fdig/4)
PM_CONF2	77	00	7:0	KRM[7:0]	Sets the divider ratio (LSB) of the rate multiplier (default: Fsw=Fdig/4)
PM_CONF1	78	39	7	RESERVED	-
			6	BATTERY_LVL_EN	1: enable battery level detector circuit.
			5:4	SET_BLD_TH	Set the BLD threshold: <ul style="list-style-type: none"> <li>00b: 2.7 V</li> <li>01b: 2.5 V</li> <li>10b: 2.3 V</li> <li>11b: 2.1 V.</li> </ul>
			3	SMPS_LVL_MODE	<ul style="list-style-type: none"> <li>0: SMPS output level depends upon the value written in the PM_CONFIG0 register (SET_SMPS_LEVEL field) both in RX and TX state.</li> <li>1: SMPS output level depends upon the value in PM_CONFIG register just in TX state, while in RX state it is fixed to 1.4 V</li> </ul>
			2	BYPASS_LDO	Set to 0 (default value)
			1:0	RESERVED	-
PM_CONF0	79	42	7	RESERVED	-
			6:4	SET_SMPS_LVL	SMPS output voltage: <ul style="list-style-type: none"> <li>000b: not used</li> <li>001b: 1.2 V</li> <li>010b: 1.3 V</li> <li>011b: 1.4 V</li> <li>100b: 1.5 V</li> <li>101b: 1.6 V</li> <li>110b: 1.7 V</li> <li>111b: 1.8 V</li> </ul>
			3:1	RESERVED	-
			0	SLEEP_MODE_SEL	<ul style="list-style-type: none"> <li>0: SLEEP without FIFO retention (SLEEP A)</li> <li>1: SLEEP with FIFO retention (SLEEP B).</li> </ul>
MC_STATE1	8D	52	7:5	RESERVED	-
			4	RCO_CAL_OK	RCO calibration successfully terminated.
			3	ANT_SEL	Currently selected antenna.
			2	TX_FIFO_FULL	1: TX FIFO is full.
			1	RX_FIFO_EMPTY	1: RX FIFO is empty.
			0	ERROR_LOCK	1: RCO calibrator error.
MC_STATE0	8E	07	7:1	STATE	Current state.
			0	XO_ON	1: XO is operating.
TX_FIFO_STATUS	8F	00	7:0	NELEM_TXFIFO	Number of elements in TX FIFO.
RX_FIFO_STATUS	90	00	7:0	NELEM_RXFIFO	Number of elements in RX FIFO.
RCO_CALIBR_OUT4	94	70	7:4	RWT_OUT	RWT word from internal RCO calibrator.
			3:0	RFB_OUT[4:1]	RFB word (MSB) from internal RCO calibrator.
RCO_CALIBR_OUT3	95	00	7	RFB_OUT[0]	RF word (LSB) from internal RCO calibrator.
			6:0	RESERVED	-
VCO_CALIBR_OUT1	99	00	7:4	RESERVED	-

Name	Addr	Default	Bit	Field name	Description
VCO_CALIBR_OUT1	99	00	3:0	VCO_CAL_AMP_OUT	VCO magnitude calibration output word (binary coding internally converted from thermometric coding).
VCO_CALIBROUT0	9A	00	7	RESERVED	-
			6:0	VCO_CAL_FREQ_OUT	VCO Cbank frequency calibration output word (binary coding internally converted from thermometric coding).
TX_PCKT_INFO	9C	00	7:6	RESERVED	-
			5:4	TX_SEQ_NUM	Current TX packet sequence number.
			3:0	N_RETX	Number of re-transmissions done for the last TX packet.
RX_PCKT_INFO	9D	00	7:3	RESERVED	-
			2	NACK_RX	NACK field of the received packet.
			1:0	RX_SEQ_NUM	Sequence number of the received packet.
AFC_CORR	9E	00	7:0	AFC_CORR	AFC corrected value.
LINK_QUALIF2	9F	00	7:0	PQI	PQI value of the received packet.
LINK_QUALIF1	A0	00	7	CS	Carrier sense indication.
			6:0	SQI	SQI value of the received packet.
RSSI_LEVEL	A2	00	7:0	RSSI_LEVEL	RSSI level captured at the end of the SYNC word detection of the received packet.
RX_PCKT_LEN1	A4	00	7:0	RX_PCKT_LEN[14:8]	MSB value of the length of the packet received.
RX_PCKT_LEN0	A5	00	7:0	RX_PCKT_LEN[7:0]	LSB value of the length of the packet received.
CRC_FIELD3	A6	00	7:0	CRC_FIELD3	CRC field 3 of the received packet.
CRC_FIELD2	A7	00	7:0	CRC_FIELD2	CRC field 2 of the received packet.
CRC_FIELD1	A8	00	7:0	CRC_FIELD1	CRC field 1 of the received packet.
CRC_FIELD0	A9	00	7:0	CRC_FIELD0	CRC field 0 of the received packet.
RX_ADDRE_FIELD1	AA	00	7:0	RX_ADDRE_FIELD1	Source address field of the received packet.
RX_ADDRE_FIELD0	AB	00	7:0	RX_ADDRE_FIELD0	Destination address field of the received packet.
RSSI_LEVEL_RUN	EF	00	7:0	RSSI_LEVEL_RUN	RSSI level of the received packet, which supports continuous fast SPI reading.
DEVICE_INFO1	F0	03	7:0	PARTNUM	S2-LP part number
DEVICE_INFO0	F1	C1	7:0	VERSION	S2-LP version number
IRQ_STATUS3	FA	00	7:0	INT_LEVEL[31:24]	Interrupt status register 3
IRQ_STATUS2	FB	09	7:0	INT_LEVEL[23:16]	Interrupt status register 2
IRQ_STATUS1	FC	05	7:0	INT_LEVEL[15:8]	Interrupt status register 1
IRQ_STATUS0	FD	00	7:0	INT_LEVEL[7:0]	Interrupt status register 0

## 11 Package information

In order to meet environmental requirements, ST offers these devices in different grades of **ECOPACK** packages, depending on their level of environmental compliance. ECOPACK specifications, grade definitions and product status are available at: [www.st.com](http://www.st.com). ECOPACK is an ST trademark.

### 11.1 QFN24L (4x4 mm) package information

Figure 30. QFN24L (4x4 mm) package outline

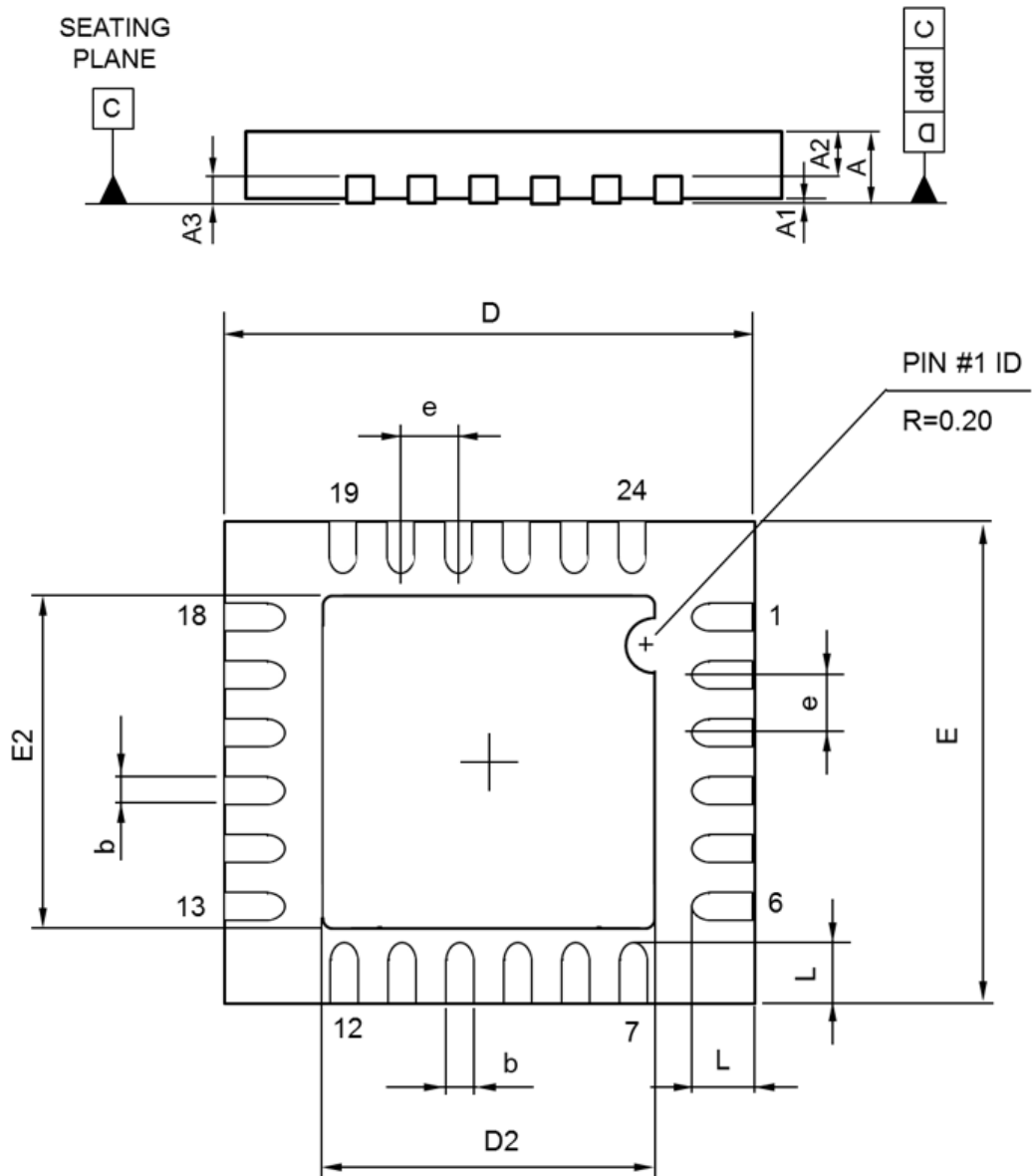


Table 64. QFN24L (4x4 mm) package mechanical data

Dim.	mm		
	Min.	Typ.	Max.
A	0.95	1.00	1.05

Dim.	mm		
	Min.	Typ.	Max.
A1	-	0.02	0.05
A2	-	0.65	1.00
A3	-	0.20	-
b	0.18	0.25	0.30
D	3.85	4.00	4.15
D2	2.60	2.70	2.80
E	3.85	4.00	4.15
E2	2.60	2.70	2.80
e	-	0.50	-
L	0.35	0.40	0.45
ddd	-	-	0.08

## 11.2 PCB pad pattern

In order to design a proper pad pattern, tolerance analysis is required on package and motherboard dimensions. The tolerance analysis requires consideration of component tolerances, PCB tolerances and the accuracy of the equipment used to place the component.

For the pad dimensioning three different minimum values have been considered:

- Minimum toe fillet = JTmin = 0.1 mm
- Minimum heel fillet = JHmin = 0.05 mm
- Minimum side fillet = JSmin = 0 mm

The PCB thermal pad should at least match the exposed die paddle size. The solder mask opening should be 120 to 150 microns larger than the pad size resulting in 60 to 75 microns clearance between the copper pas and solder mask.

Figure 31. QFN24 4x4x1pitch 0.5 mm PCB pad pattern

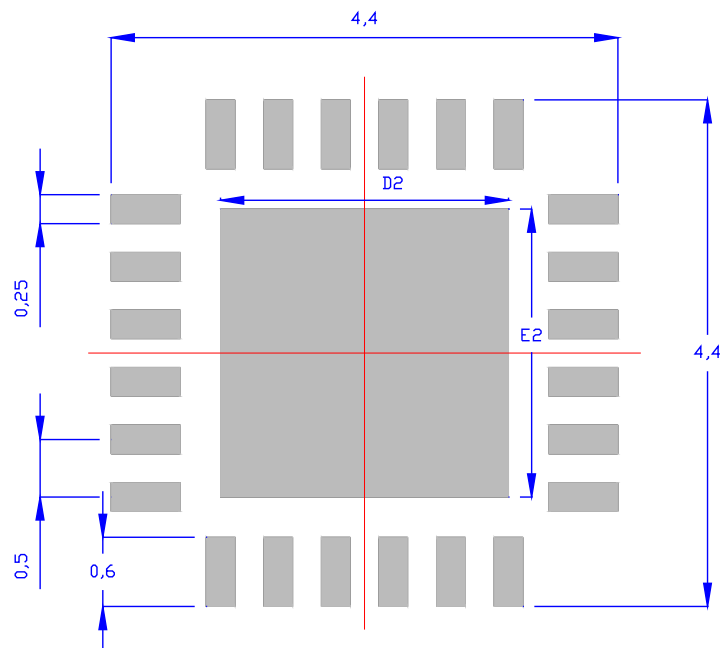


Table 65. Exposed pad dimension

D2 (mm)	E2 (mm)
2.70	2.70

### 11.3 QFN recommended profile parameters

The temperature profile is the most important control in the re-flow soldering and it must be fine tuned to establish a robust process. QFN recommended soldering profile for lead-free mounting is shown in the following table and picture.

Figure 32. QFN recommended soldering profiles

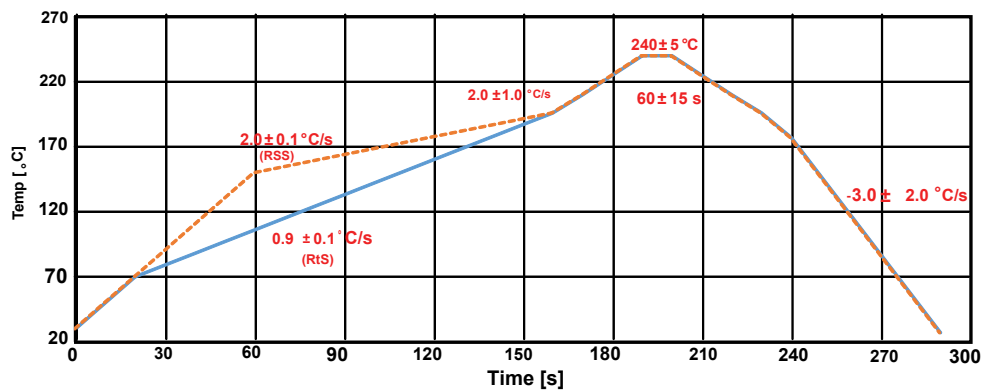


Table 66. Temperature profiles

Profile	Ramp-to-spike	Ramp-soak-spike
Temperature gradient in preheat	T from 70 °C to 150 °C 0.8 °C/s to 1.0 °C/s	T from 70 °C to 150 °C 1 °C/s to 3 °C/s
Soak/dwell ( refer to solder paste supplier recommendation)	N/A or temp.: 150 °C to 200 °C, 40 to 80 s	Soak 150 °C to 200 °C, 40 to 100 s
Temperature gradient in preheat	Temp.: 200 °C to 225 °C, 1 °C/s to 3 °C/s	Temp.: 200 °C to 225 °C, 1 °C/s to 3 °C/s
Peak temperature	235 °C to 245 °C	
Duration above 220 °C	45 to 75 s	
Temperature gradient in cooling	-1 °C to -5 °C	
Time from 50 to 220 °C	150 to 230 s	

## 12 Ordering information

**Table 67. Ordering information**

Order code	Package	Packing
S2-LPQTR	QFN24 4x4x1	Tape and reel
S2-LPCBQTR	QFN24 4x4x1	Tape and reel

## 13 Important security notice

The STMicroelectronics group of companies (ST) places a high value on product security, which is why the ST product(s) identified in this documentation may be certified by various security certification bodies and/or may implement our own security measures as set forth herein. However, no level of security certification and/or built-in security measures can guarantee that ST products are resistant to all forms of attacks. As such, it is the responsibility of each of ST's customers to determine if the level of security provided in an ST product meets the customer needs both in relation to the ST product alone, as well as when combined with other components and/or software for the customer end product or application. In particular, take note that:

- ST products may have been certified by one or more security certification bodies, such as Platform Security Architecture ([www.psacertified.org](http://www.psacertified.org)) and/or Security Evaluation standard for IoT Platforms ([www.trustcb.com](http://www.trustcb.com)). For details concerning whether the ST product(s) referenced herein have received security certification along with the level and current status of such certification, either visit the relevant certification standards website or go to the relevant product page on [www.st.com](http://www.st.com) for the most up to date information. As the status and/or level of security certification for an ST product can change from time to time, customers should re-check security certification status/level as needed. If an ST product is not shown to be certified under a particular security standard, customers should not assume it is certified.
- Certification bodies have the right to evaluate, grant and revoke security certification in relation to ST products. These certification bodies are therefore independently responsible for granting or revoking security certification for an ST product, and ST does not take any responsibility for mistakes, evaluations, assessments, testing, or other activity carried out by the certification body with respect to any ST product.
- Industry-based cryptographic algorithms (such as AES, DES, or MD5) and other open standard technologies which may be used in conjunction with an ST product are based on standards which were not developed by ST. ST does not take responsibility for any flaws in such cryptographic algorithms or open technologies or for any methods which have been or may be developed to bypass, decrypt or crack such algorithms or technologies.
- While robust security testing may be done, no level of certification can absolutely guarantee protections against all attacks, including, for example, against advanced attacks which have not been tested for, against new or unidentified forms of attack, or against any form of attack when using an ST product outside of its specification or intended use, or in conjunction with other components or software which are used by customer to create their end product or application. ST is not responsible for resistance against such attacks. As such, regardless of the incorporated security features and/or any information or support that may be provided by ST, each customer is solely responsible for determining if the level of attacks tested for meets their needs, both in relation to the ST product alone and when incorporated into a customer end product or application.
- All security features of ST products (inclusive of any hardware, software, documentation, and the like), including but not limited to any enhanced security features added by ST, are provided on an "AS IS" BASIS. AS SUCH, TO THE EXTENT PERMITTED BY APPLICABLE LAW, ST DISCLAIMS ALL WARRANTIES, EXPRESS OR IMPLIED, INCLUDING BUT NOT LIMITED TO THE IMPLIED WARRANTIES OF MERCHANTABILITY OR FITNESS FOR A PARTICULAR PURPOSE, unless the applicable written and signed contract terms specifically provide otherwise.

## Revision history

**Table 68. Document revision history**

Date	Version	Changes
08-Nov-2016	1	Initial release.
26-Jan-2017	2	Minor text changes throughout the document.
13-Mar-2018	3	Updated Section Features, Section 1 Description, Section 5.1 Power management, Section 5.3 RF synthesizer, Section 5.3.1 RF channel frequency settings and Section 7.2 SStack packet. Updated Figure 13. Data whitening scheme. Minor text changes throughout the document.
10-May-2018	4	Updated figure and features in cover page. Updated Table 42. Constellation mapping 4-(G)FSK.
06-Nov-2018	5	Updated Figure 3. Suggested application diagram (embedded SMPS not used), Figure 5. Pin diagram, QFN24 (4x4 mm) package. Updated Section 4.4 Power consumption, Section 4.9 RF transmitter, Section 5.2 Power-On-Reset, Section 10 Register contents. Added Section 11.3 QFN recommended profile parameters. Minor text changes throughout the document.
13-Jun-2019	6	Updated Table 40. Modulation scheme and Table 62. Register contents.
18-Sep-2020	7	Added features "KNX-RF supported" on the cover page.
06-May-2021	8	Updated Table 63. Register contents..
08-Sep-2021	9	Updated Eq. (3), Figure 22. Flowchart of the S2-LP CSMA procedure, Figure 25. CSMA with non-persistent mode if channel is busy (timeline) and Figure 26. CSMA with non-persistent mode if channel becomes free (timeline). Updated Figure 31. QFN24 4x4x1pitch 0.5 mm PCB pad pattern.
28-Jun-2022	10	Updated Section 4.1 Absolute maximum ratings, Section 4.8.2 Sensitivity at 433 MHz, Section 4.8.5 Blocking and selectivity at 868 MHz, Section 4.8.6 Sensitivity at 868 MHz, Section 4.8.8 Sensitivity at 915 MHz, Section 5.5.1 Automatic frequency compensation, Section 5.5.8.1 RSSI, Section 6 Operating modes, Section 6.1 Command list, Section 7.8.2 Manchester coding, Section 7.9 CRC, Section 8.1 Automatic acknowledgment, Section 8.2.1 Low duty cycle mode, Section 8.3 CSMA/CA engine, Section 10 Register contents. Added Table 60. IRQ type S2-LP state.
17-Mar-2023	11	Updated <a href="#">Table 27. PA impedance</a> , <a href="#">Table 49. Commands</a> , <a href="#">Table 60. IRQ type S2-LP state</a>
22-Jan-2025	12	Updated: <ul style="list-style-type: none"> <li>• <a href="#">Section 5.5.9: CS blanking</a></li> <li>• <a href="#">Section 5.5.10: Antenna switching (equation 16)</a></li> <li>• <a href="#">Table 52. Preamble field selection</a></li> </ul>
08-Oct-2025	13	Added footnote to VESD-HBM maximum value in <a href="#">Table 3. Absolute maximum ratings</a> .

## Contents

<b>1</b>	<b>Description</b> .....	<b>3</b>
<b>2</b>	<b>Detailed functional description</b> .....	<b>4</b>
<b>3</b>	<b>Typical application diagram and pin description</b> .....	<b>6</b>
3.1	Pin diagram .....	9
3.2	Pin description .....	9
<b>4</b>	<b>Specifications</b> .....	<b>11</b>
4.1	Absolute maximum ratings .....	11
4.2	Operating range .....	11
4.3	Thermal properties .....	11
4.4	Power consumption .....	11
4.5	General characterization .....	13
4.6	Frequency synthesizer .....	13
4.7	Crystal oscillator .....	14
4.8	RF receiver .....	15
4.8.1	Blocking and selectivity at 433 MHz .....	15
4.8.2	Sensitivity at 433 MHz .....	16
4.8.3	Blocking and selectivity @ 510 MHz .....	17
4.8.4	Sensitivity at 510 MHz .....	17
4.8.5	Blocking and selectivity at 868 MHz .....	18
4.8.6	Sensitivity at 868 MHz .....	18
4.8.7	Blocking and selectivity at 915 MHz .....	19
4.8.8	Sensitivity at 915 MHz .....	19
4.9	RF transmitter .....	20
4.9.1	Harmonic emission at 433 MHz .....	20
4.9.2	Harmonic emission at 510 MHz .....	21
4.9.3	Harmonic emission at 840-868 MHz .....	21
4.9.4	Harmonic emission at 915 MHz .....	21
4.10	Digital interface specification .....	22
4.11	Battery indicator .....	22
<b>5</b>	<b>Block description</b> .....	<b>23</b>
5.1	Power management .....	23
5.2	Power-On-Reset .....	24
5.3	RF synthesizer .....	25
5.3.1	RF channel frequency settings .....	26
5.4	Digital modulator .....	27

5.4.1	Frequency modulation . . . . .	28
5.4.2	Amplitude modulation . . . . .	29
5.4.3	Direct polar mode . . . . .	30
5.4.4	Test modes . . . . .	31
5.4.5	Data rate . . . . .	31
<b>5.5</b>	<b>Receiver . . . . .</b>	<b>31</b>
5.5.1	Automatic frequency compensation . . . . .	31
5.5.2	Automatic gain control . . . . .	32
5.5.3	Symbol timing recovery . . . . .	33
5.5.4	RX channel filter bandwidth . . . . .	33
5.5.5	Intermediate frequency setting . . . . .	34
5.5.6	RX timer management . . . . .	34
5.5.7	Receiver data modes . . . . .	35
5.5.8	Receiver quality indicators . . . . .	35
5.5.9	CS blanking . . . . .	36
5.5.10	Antenna switching . . . . .	36
<b>5.6</b>	<b>Transmitter . . . . .</b>	<b>36</b>
5.6.1	PA configuration . . . . .	37
5.6.2	Transmitter data modes . . . . .	38
5.6.3	Data FIFO . . . . .	38
<b>5.7</b>	<b>Integrated RCO . . . . .</b>	<b>40</b>
<b>5.8</b>	<b>Low battery indicator . . . . .</b>	<b>40</b>
<b>5.9</b>	<b>Voltage reference . . . . .</b>	<b>40</b>
<b>6</b>	<b>Operating modes . . . . .</b>	<b>41</b>
6.1	Command list . . . . .	42
6.2	State transaction response time . . . . .	43
6.3	Sleep states . . . . .	43
<b>7</b>	<b>Packet handler engine . . . . .</b>	<b>44</b>
7.1	BASIC packet format . . . . .	44
7.2	STack packet . . . . .	45
7.3	802.15.4g packet . . . . .	46
7.4	UART over the air packet format . . . . .	48
7.5	Wireless MBUS packet (W-MBUS, EN13757-4) . . . . .	48
7.6	Payload transmission order . . . . .	48
7.7	Automatic packet filtering . . . . .	49
7.8	Data coding and integrity check . . . . .	49
7.8.1	FEC . . . . .	49

7.8.2	Manchester coding .....	50
7.8.3	3-out-of-6 coding .....	50
7.9	CRC .....	50
7.10	Data whitening .....	51
<b>8</b>	<b>Link layer protocol.....</b>	<b>52</b>
8.1	Automatic acknowledgment .....	52
8.1.1	Automatic acknowledgment with piggybacking .....	52
8.1.2	Automatic retransmission .....	53
8.2	Timeout protocol engine .....	53
8.2.1	Low duty cycle mode .....	54
8.2.2	Sniff mode .....	56
8.3	CSMA/CA engine .....	58
<b>9</b>	<b>MCU interface .....</b>	<b>61</b>
9.1	Serial peripheral interface .....	61
9.2	Interrupts .....	62
9.3	GPIOs.....	64
<b>10</b>	<b>Register contents.....</b>	<b>66</b>
<b>11</b>	<b>Package information.....</b>	<b>76</b>
11.1	QFN24L (4x4 mm) package information .....	76
11.2	PCB pad pattern .....	77
11.3	QFN recommended profile parameters .....	78
<b>12</b>	<b>Ordering information .....</b>	<b>79</b>
<b>13</b>	<b>Important security notice .....</b>	<b>80</b>
	<b>Revision history .....</b>	<b>81</b>

## List of figures

<b>Figure 1.</b>	Simplified S2-LP block diagram . . . . .	4
<b>Figure 2.</b>	Suggested application diagram (embedded SMPS used) . . . . .	6
<b>Figure 3.</b>	Suggested application diagram (embedded SMPS not used) . . . . .	7
<b>Figure 4.</b>	Suggested application diagram HPM/LPM (integrated balun, embedded SMPS used) . . . . .	7
<b>Figure 5.</b>	Pin diagram, QFN24 (4x4 mm) package . . . . .	9
<b>Figure 6.</b>	Power-On-Reset timing and limits . . . . .	24
<b>Figure 7.</b>	Start-up phase . . . . .	25
<b>Figure 8.</b>	Examples of possible connections for SDN pin . . . . .	25
<b>Figure 9.</b>	Direct polar mode . . . . .	30
<b>Figure 10.</b>	Output power ramping configuration . . . . .	38
<b>Figure 11.</b>	Threshold in FIFO . . . . .	39
<b>Figure 12.</b>	State diagram . . . . .	41
<b>Figure 13.</b>	Data whitening scheme . . . . .	51
<b>Figure 14.</b>	Data whitening scheme 802.15.4g . . . . .	51
<b>Figure 15.</b>	Automatic retransmission scenario . . . . .	53
<b>Figure 16.</b>	Common RX operation . . . . .	54
<b>Figure 17.</b>	LDC RX operation . . . . .	54
<b>Figure 18.</b>	LDC in TX with auto-ack . . . . .	56
<b>Figure 19.</b>	LDC in RX with auto-ack . . . . .	56
<b>Figure 20.</b>	Fast RX termination mode with LDC . . . . .	57
<b>Figure 21.</b>	Fast Rx termination: CS detection . . . . .	57
<b>Figure 22.</b>	Flowchart of the S2-LP CSMA procedure . . . . .	58
<b>Figure 23.</b>	CSMA if channel is free (timeline) . . . . .	59
<b>Figure 24.</b>	CSMA with persistent mode if channel is busy (timeline) . . . . .	59
<b>Figure 25.</b>	CSMA with non-persistent mode if channel is busy (timeline) . . . . .	60
<b>Figure 26.</b>	CSMA with non-persistent mode if channel becomes free (timeline) . . . . .	60
<b>Figure 27.</b>	SPI write sequence . . . . .	61
<b>Figure 28.</b>	SPI read sequence . . . . .	62
<b>Figure 29.</b>	SPI command sequence . . . . .	62
<b>Figure 30.</b>	QFN24L (4x4 mm) package outline . . . . .	76
<b>Figure 31.</b>	QFN24 4x4x1pitch 0.5 mm PCB pad pattern . . . . .	77
<b>Figure 32.</b>	QFN recommended soldering profiles . . . . .	78

## List of tables

<b>Table 1.</b>	Description of the external components of the typical application diagrams . . . . .	8
<b>Table 2.</b>	Pinout . . . . .	9
<b>Table 3.</b>	Absolute maximum ratings . . . . .	11
<b>Table 4.</b>	Operating range. . . . .	11
<b>Table 5.</b>	Thermal data. . . . .	11
<b>Table 6.</b>	Low-power state power consumption . . . . .	11
<b>Table 7.</b>	Power consumption in reception TA = 25 °C, VDD = 3.3 V, fc = 868 MHz . . . . .	12
<b>Table 8.</b>	Power consumption in transmission fc= 915 MHz. . . . .	12
<b>Table 9.</b>	Power consumption in transmission fc= 840-868 MHz . . . . .	12
<b>Table 10.</b>	Power consumption in transmission fc= 434 MHz. . . . .	12
<b>Table 11.</b>	Power consumption in transmission fc = 510 MHz . . . . .	13
<b>Table 12.</b>	General characteristics . . . . .	13
<b>Table 13.</b>	Data rate with different coding options . . . . .	13
<b>Table 14.</b>	Frequency synthesizer parameters. . . . .	13
<b>Table 15.</b>	Crystal oscillator characteristics . . . . .	14
<b>Table 16.</b>	Ultra-low power RC oscillator. . . . .	15
<b>Table 17.</b>	RF receiver characteristics . . . . .	15
<b>Table 18.</b>	Blocking and selectivity at 433 MHz . . . . .	15
<b>Table 19.</b>	Sensitivity at 433 MHz . . . . .	16
<b>Table 20.</b>	Blocking and selectivity @ 510 MHz . . . . .	17
<b>Table 21.</b>	Sensitivity at 510 MHz . . . . .	17
<b>Table 22.</b>	Blocking and selectivity @ 868 MHz . . . . .	18
<b>Table 23.</b>	Sensitivity at 868 MHz . . . . .	18
<b>Table 24.</b>	Blocking and selectivity at 915 MHz . . . . .	19
<b>Table 25.</b>	Sensitivity at 915 MHz . . . . .	19
<b>Table 26.</b>	RF transmitter characteristics . . . . .	20
<b>Table 27.</b>	PA impedance . . . . .	20
<b>Table 28.</b>	Regulatory standards . . . . .	20
<b>Table 29.</b>	Harmonic emission at 433 MHz . . . . .	20
<b>Table 30.</b>	Harmonic emission at 510 MHz . . . . .	21
<b>Table 31.</b>	Harmonic emission at 840-868 MHz. . . . .	21
<b>Table 32.</b>	Harmonic emission at 915 MHz . . . . .	21
<b>Table 33.</b>	Digital SPI input, output and GPIO specification. . . . .	22
<b>Table 34.</b>	Battery indicator and low battery detector . . . . .	22
<b>Table 35.</b>	SMPS output voltage . . . . .	23
<b>Table 36.</b>	POR parameters . . . . .	24
<b>Table 37.</b>	Charge pump words. . . . .	26
<b>Table 38.</b>	Resolution frequency . . . . .	27
<b>Table 39.</b>	Channel spacing resolution . . . . .	27
<b>Table 40.</b>	Modulation scheme . . . . .	27
<b>Table 41.</b>	Constellation mapping 2-(G)FSK . . . . .	28
<b>Table 42.</b>	Constellation mapping 4-(G)FSK . . . . .	28
<b>Table 43.</b>	PA Bessel filter words. . . . .	30
<b>Table 44.</b>	Channel filter words . . . . .	34
<b>Table 45.</b>	RX timer stop condition configuration . . . . .	34
<b>Table 46.</b>	CS mode description . . . . .	35
<b>Table 47.</b>	RCO Frequency. . . . .	40
<b>Table 48.</b>	State description . . . . .	41
<b>Table 49.</b>	Commands . . . . .	42
<b>Table 50.</b>	Response time . . . . .	43
<b>Table 51.</b>	BASIC packet format . . . . .	44
<b>Table 52.</b>	Preamble field selection . . . . .	44
<b>Table 53.</b>	STack packet. . . . .	45

<b>Table 54.</b>	802.15.4g packet . . . . .	46
<b>Table 55.</b>	PHR frame . . . . .	47
<b>Table 56.</b>	UART over the air packet format . . . . .	48
<b>Table 57.</b>	3-out-of-6 coding scheme . . . . .	50
<b>Table 58.</b>	Timer description and duration (the values are related to $f_{\text{dig}}$ of 26 MHz) . . . . .	53
<b>Table 59.</b>	Interrupts list . . . . .	62
<b>Table 60.</b>	IRQ type S2-LP state . . . . .	63
<b>Table 61.</b>	GPIO digital output functions . . . . .	64
<b>Table 62.</b>	GPIO digital input functions . . . . .	65
<b>Table 63.</b>	Register contents. . . . .	66
<b>Table 64.</b>	QFN24L (4x4 mm) package mechanical data . . . . .	76
<b>Table 65.</b>	Exposed pad dimension . . . . .	78
<b>Table 66.</b>	Temperature profiles. . . . .	78
<b>Table 67.</b>	Ordering information. . . . .	79
<b>Table 68.</b>	Document revision history . . . . .	81

**IMPORTANT NOTICE – READ CAREFULLY**

STMicroelectronics NV and its subsidiaries (“ST”) reserve the right to make changes, corrections, enhancements, modifications, and improvements to ST products and/or to this document at any time without notice.

In the event of any conflict between the provisions of this document and the provisions of any contractual arrangement in force between the purchasers and ST, the provisions of such contractual arrangement shall prevail.

The purchasers should obtain the latest relevant information on ST products before placing orders. ST products are sold pursuant to ST's terms and conditions of sale in place at the time of order acknowledgment.

The purchasers are solely responsible for the choice, selection, and use of ST products and ST assumes no liability for application assistance or the design of the purchasers' products.

No license, express or implied, to any intellectual property right is granted by ST herein.

Resale of ST products with provisions different from the information set forth herein shall void any warranty granted by ST for such product.

If the purchasers identify an ST product that meets their functional and performance requirements but that is not designated for the purchasers' market segment, the purchasers shall contact ST for more information.

ST and the ST logo are trademarks of ST. For additional information about ST trademarks, refer to [www.st.com/trademarks](http://www.st.com/trademarks). All other product or service names are the property of their respective owners.

Information in this document supersedes and replaces information previously supplied in any prior versions of this document.







© 2025 STMicroelectronics – All rights reserved

## Looking for pricing, stock, or lifecycle information?

Click below to explore more details on WIN SOURCE:

-  [View S2-LPCBQTR on WIN SOURCE](#)
-  [STMicroelectronics Information](#)

## Optimize Your Supply Chain with WIN SOURCE Solutions

-  Global Sourcing Solution
-  Obsolete Management
-  Cost Control Management
-  Shortage Management
-  Alternative Solution
-  Excess Inventory Management