



**THE DATASHEET OF
TPS281C100ADNTR**



TPS7A02 Nanopower I_Q , 25-nA, 200-mA, Low-Dropout Voltage Regulator With Fast Transient Response

1 Features

- Ultra-low I_Q : 25 nA (typ), even in dropout
- Shutdown I_Q : 3 nA (typ)
- Excellent transient response (1 mA to 50 mA)
 - < 10- μ s settling time
 - 100-mV undershoot
- Packages:
 - 1.0-mm \times 1.0-mm X2SON
 - SOT23-5
 - 0.64-mm \times 0.64-mm DSBGA
- Input voltage range: 1.5 V to 6.0 V
- Output voltage range: 0.8 V to 5.0 V (fixed)
- Output accuracy: 1.5% over temperature
- Smart enable pulldown
- Very low dropout:
 - 270 mV (max) at 200 mA ($V_{OUT} = 3.3$ V)
- Stable with a 1- μ F or larger capacitor

2 Applications

- [Wearables electronics](#)
- [Thermostats, smoke and heat detectors](#)
- [Gas, heat, and water meters](#)
- [Blood glucose monitors and pulse oximeters](#)
- [Residential circuit breakers and fault indicators](#)
- [Building security and video surveillance devices](#)
- [EPOS card readers](#)

3 Description

The TPS7A02 is an ultra-small, ultra-low quiescent current low-dropout linear regulator (LDO) that can source 200 mA with excellent transient performance.

The TPS7A02, with an ultra-low I_Q of 25 nA, is designed specifically for applications where very-low quiescent current is a critical parameter. This device maintains low I_Q consumption even in dropout mode to further increase battery life. When in shutdown or disabled mode, the device consumes ultra-low, 3-nA I_Q that helps increase the shelf life of the battery. The TPS7A02 has an output range of 0.8 V to 5.0 V available in 50-mV steps to support the lower core voltages of modern microcontrollers (MCUs).

The TPS7A02 features a smart enable circuit with an internally controlled pulldown resistor that keeps the LDO disabled even when the EN pin is left floating and helps minimize the external components used to pulldown the EN pin. This circuit also helps minimize the current drawn through the external pulldown circuit when the device is enabled.

The TPS7A02 is fully specified for $T_J = -40^\circ\text{C}$ to $+125^\circ\text{C}$ operation.

Package Information⁽¹⁾

PART NUMBER	PACKAGE	BODY SIZE (NOM)
TPS7A02	DQN (X2SON, 4)	1.00 mm \times 1.00 mm
	YCH (DSBGA, 4)	0.64 mm \times 0.64 mm
	DBV (SOT-23, 5)	2.90 mm \times 1.60 mm

- (1) For all available packages, see the package option addendum at the end of the data sheet.

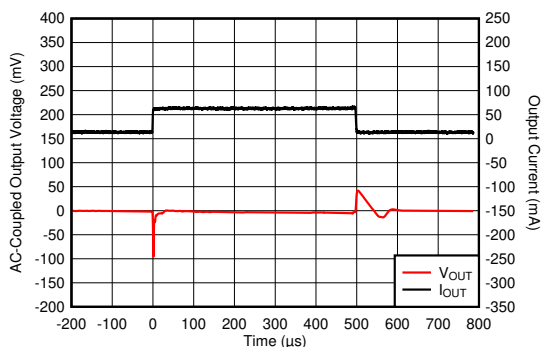

Load Transient Response ($V_{IN} = V_{OUT} + 1$ V, $C_{OUT} = 1$ μ F, $I_{OUT} = 1$ mA to 50 mA in 1 μ s)

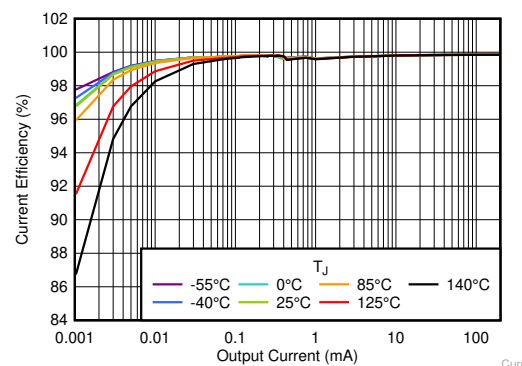

Ground Current Efficiency vs Output Current



Table of Contents

1 Features	1	7.3 Feature Description.....	19
2 Applications	1	7.4 Device Functional Modes.....	22
3 Description	1	8 Application and Implementation	23
4 Revision History	2	8.1 Application Information.....	23
5 Pin Configuration and Functions	3	8.2 Typical Application.....	26
6 Specifications	4	8.3 Power Supply Recommendations.....	27
6.1 Absolute Maximum Ratings.....	4	8.4 Layout.....	27
6.2 ESD Ratings.....	4	9 Device and Documentation Support	29
6.3 Recommended Operating Conditions.....	5	9.1 Device Support.....	29
6.4 Thermal Information.....	5	9.2 Receiving Notification of Documentation Updates....	29
6.5 Electrical Characteristics.....	6	9.3 Support Resources.....	29
6.6 Switching Characteristics.....	7	9.4 Trademarks.....	29
6.7 Typical Characteristics.....	8	9.5 Electrostatic Discharge Caution.....	29
7 Detailed Description	18	9.6 Glossary.....	29
7.1 Overview.....	18	10 Mechanical, Packaging, and Orderable Information	29
7.2 Functional Block Diagram.....	18		

4 Revision History

NOTE: Page numbers for previous revisions may differ from page numbers in the current version.

Changes from Revision B (March 2020) to Revision C (September 2022)	Page
• Changed YCH (DGBGA) package from preview to production data.....	1

Changes from Revision A (December 2019) to Revision B (March 2020)	Page
• Changed DBV (SOT23-5) package from preview to production data.....	1

5 Pin Configuration and Functions

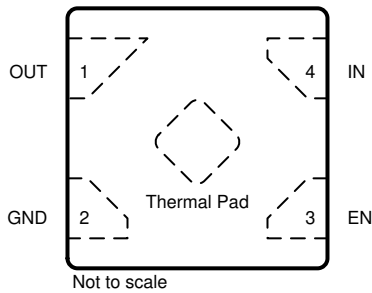

Figure 5-1. DQN Package, 1-mm × 1-mm, 4-Pin X2SON (Top View)

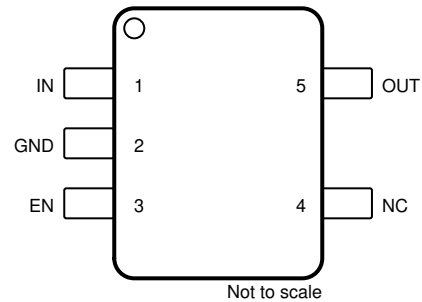

Figure 5-2. DBV Package, 5-Pin SOT-23 (Top View)

Table 5-1. Pin Functions: DQN, DBV

NAME	PIN		I/O ⁽¹⁾	DESCRIPTION
	DQN	DBV		
EN	3	3	Input	Enable pin. Driving this pin to logic high enables the device; driving this pin to logic low or floating this pin disables the device. This pin features an internal pulldown resistor, which is disconnected when EN is driven high externally and the device has started up.
GND	2	2	—	Ground pin. This pin must be connected to ground on the board.
IN	4	1	Input	Input pin. For best transient response and to minimize input impedance, use the recommended value or larger ceramic capacitor from IN to ground; see the Recommended Operating Conditions table. Place the input capacitor as close to the input of the device as possible.
NC	—	4	—	No connect pin. This pin is not internally connected. Connect to ground or leave floating.
OUT	1	5	Output	Regulated output pin. A 0.5- μ F or greater effective capacitance is required from OUT to ground for stability. For best transient response, use a 1- μ F or larger ceramic capacitor from OUT to ground. Place the output capacitor as close to output of the device as possible; see the Recommended Operating Conditions table.
Thermal pad	—	—	—	Connect the thermal pad to a large-area ground plane. The thermal pad is internally connect to ground.

(1) NC = No internal connection.

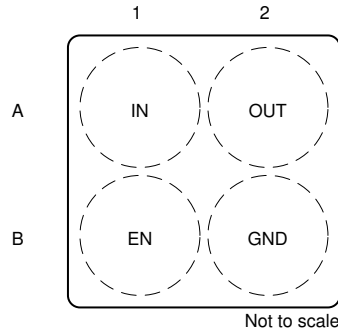

Figure 5-3. YCH Package, 4-Pin DSBGA, 0.35-mm Pitch (Top View)

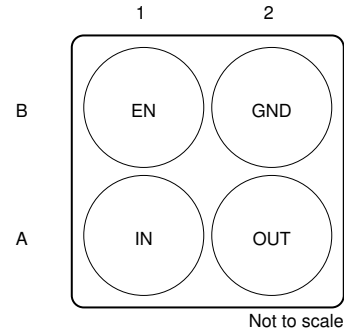

Figure 5-4. YCH Package, 4-Pin DSBGA, 0.35-mm Pitch (Bottom View)

Table 5-2. Pin Functions: YCH

PIN		I/O	DESCRIPTION
YCH	NAME		
A1	IN	Input	Input pin. For best transient response and to minimize input impedance, use the recommended value or larger ceramic capacitor from IN to ground; see the Recommended Operating Conditions table. Place the input capacitor as close to input of the device as possible.
A2	OUT	Output	Regulated output pin. A 0.5- μ F or greater effective capacitance is required from OUT to ground for stability. For best transient response, use a 1- μ F or larger ceramic capacitor from OUT to ground. Place the output capacitor as close to output of the device as possible; see the Recommended Operating Conditions table.
B1	EN	Input	Enable pin. Driving this pin to logic high enables the device; driving this pin to logic low or floating this pin disables the device. This pin features an internal pulldown resistor, which is disconnected when EN is driven high externally and the device has started up.
B2	GND	—	Ground pin. This pin must be connected to ground and the thermal pad.

6 Specifications

6.1 Absolute Maximum Ratings

over operating free-air temperature range (unless otherwise noted)⁽¹⁾

		MIN	MAX	UNIT
Voltage	V_{IN}	-0.3	6.5	V
	V_{EN}	-0.3	6.5	
	V_{OUT}	-0.3	$V_{IN} + 0.3$ or 5.5 ⁽²⁾	
Current	Maximum output	Internally limited		A
Temperature	Operating junction, T_J	-40	150	°C
	Storage, T_{stg}	-65	150	

- (1) Stresses beyond those listed under *Absolute Maximum Ratings* may cause permanent damage to the device. These are stress ratings only, which do not imply functional operation of the device at these or any other conditions beyond those indicated under *Recommended Operating Conditions*. Exposure to absolute-maximum-rated conditions for extended periods may affect device reliability.

- (2) Maximum is $V_{IN} + 0.3$ V or 5.5 V, whichever is smaller.

6.2 ESD Ratings

			VALUE	UNIT
$V_{(ESD)}$	Electrostatic discharge	Human-body model (HBM), per ANSI/ESDA/JEDEC JS-001 ⁽¹⁾	± 1000	V
		Charged-device model (CDM), per JEDEC specification JESD22-C101 ⁽²⁾	± 500	

- (1) JEDEC document JEP155 states that 500-V HBM allows safemanufacturing with a standard ESD control process.

- (2) JEDEC document JEP157 states that 250-V CDM allows safemanufacturing with a standard ESD control process.

6.3 Recommended Operating Conditions

over operating junction temperature range (unless otherwise noted)

		MIN	NOM	MAX	UNIT
V _{IN}	Input voltage	1.5		6.0	V
V _{EN}	Enable voltage	0		6.0	V
V _{OUT}	Output voltage	0.8		5.0	V
I _{OUT}	Output current	0		200	mA
C _{IN}	Input capacitor		1		μF
C _{OUT}	Output capacitor ⁽¹⁾ ⁽²⁾	1	1	22	μF
F _{EN}	EN toggle frequency			10	kHz
T _J	Operating junction temperature	-40		125	°C

- (1) Effective output capacitance of 0.5 μF minimum required for stability.
(2) 22 μF is the maximum derated capacitance that can be used for stability.

6.4 Thermal Information

THERMAL METRIC ⁽¹⁾		TPS7A02			UNIT
		DQN (X2SON)	DBV (SOT-23-5)	YCH (DSBGA)	
		4 PINS	5 PINS	4 PINS	
R _{θJA}	Junction-to-ambient thermal resistance	179.1	181.9	201.1	°C/W
R _{θJC(top)}	Junction-to-case(top) thermal resistance	137.6	53.0	2.3	°C/W
R _{θJB}	Junction-to-board thermal resistance	116.3	88.1	67.3	°C/W
ψ _{JT}	Junction-to-top characterization parameter	6.1	27.1	1.1	°C/W
ψ _{JB}	Junction-to-board characterization parameter	116.3	52.7	67.2	°C/W
R _{θJC(bot)}	Junction-to-case(bottom) thermal resistance	112.3	N/A	N/A	°C/W

- (1) For more information about traditional and new thermal metrics, see the [Semiconductor and IC Package Thermal Metrics](#) application report.

6.5 Electrical Characteristics

Specified at $T_J = -40^\circ\text{C}$ to $+125^\circ\text{C}$, $V_{IN} = V_{OUT(nom)} + 0.5\text{ V}$ or 2.0 V (whichever is greater), $I_{OUT} = 1\text{ mA}$, $V_{EN} = V_{IN}$, and $C_{IN} = C_{OUT} = 1\text{ }\mu\text{F}$ (unless otherwise noted). Typical values are at $T_J = 25^\circ\text{C}$.

PARAMETER		TEST CONDITIONS		MIN	TYP	MAX	UNIT	
	Nominal accuracy	$T_J = 25^\circ\text{C}$, $V_{OUT} \geq 1.5\text{ V}$, $1\text{ }\mu\text{A}^{(3)} \leq I_{OUT} \leq 1\text{ mA}$		-1		1	%	
		$T_J = 25^\circ\text{C}$; $V_{OUT} < 1.5\text{ V}$		-15		15	mV	
	Accuracy over temperature	$V_{OUT} \geq 1.5\text{ V}$	$T_J = -40^\circ\text{C}$ to $+125^\circ\text{C}$	-1.5		1.5	%	
		$V_{OUT} < 1.5\text{ V}$		-20		20	mV	
$\Delta V_{OUT}(\Delta V_{IN})$	Line regulation	$V_{OUT(nom)} + 0.5\text{ V} \leq V_{IN} \leq 6.0\text{ V}^{(1)}$				5	mV	
$\Delta V_{OUT}(\Delta I_{OUT})$	Load regulation ⁽²⁾	$1\text{ mA} \leq I_{OUT} \leq 200\text{ mA}$, $V_{IN} = V_{OUT(nom)} + 0.5\text{ V}^{(1)}$			20	38	mV	
						50		
I_{GND}	Ground current	$I_{OUT} = 0\text{ mA}$			25	46	nA	
						60		
I_{GND}/I_{OUT}	Ground current vs load current	$5\text{ }\mu\text{A} \leq I_{OUT} < 1\text{ mA}$			1		%	
		$1\text{ mA} \leq I_{OUT} < 100\text{ mA}$		$T_J = 25^\circ\text{C}$	0.25			
		$I_{OUT} \geq 100\text{ mA}$			0.15			
$I_{GND(DO)}$	Ground current in dropout ⁽³⁾	$I_{OUT} = 0\text{ mA}$, $V_{IN} = 95\% \times V_{OUT(NOM)}$			25		nA	
I_{SHDN}	Shutdown current	$V_{EN} = 0\text{ V}$, $1.5\text{ V} \leq V_{IN} \leq 5.0\text{ V}$, $T_J = 25^\circ\text{C}$			3	10	nA	
I_{CL}	Output current limit	$V_{OUT} = 90\% \times V_{OUT(nom)}$		$V_{OUT} < 2.5\text{ V}$, $V_{IN} = V_{OUT(nom)} + V_{DO(max)} + 1.0\text{ V}$	240	450	750	mA
				$V_{OUT} \geq 2.5\text{ V}$, $V_{IN} = V_{OUT(nom)} + V_{DO(max)} + 0.5\text{ V}$	240	450	750	mA
I_{SC}	Short-circuit current limit	$V_{OUT} = 0\text{ V}$			65		mA	
V_{DO}	Dropout voltage ⁽⁴⁾	$T_J = -40^\circ\text{C}$ to $+85^\circ\text{C}$		$0.8\text{ V} \leq V_{OUT} < 1.0\text{ V}$		1050	mV	
				$1.0\text{ V} \leq V_{OUT} < 1.2\text{ V}$		790		
				$1.2\text{ V} \leq V_{OUT} < 1.5\text{ V}$		650		
				$1.5\text{ V} \leq V_{OUT} < 1.8\text{ V}$		490		
				$1.8\text{ V} \leq V_{OUT} < 2.5\text{ V}$		400		
				$2.5\text{ V} \leq V_{OUT} < 3.3\text{ V}$		310		
				$3.3\text{ V} \leq V_{OUT} \leq 5.0\text{ V}$		270		
		$T_J = -40^\circ\text{C}$ to $+125^\circ\text{C}$		$0.8\text{ V} \leq V_{OUT} < 1.0\text{ V}$		1100		
				$1.0\text{ V} \leq V_{OUT} < 1.2\text{ V}$		850		
				$1.2\text{ V} \leq V_{OUT} < 1.5\text{ V}$		700		
				$1.5\text{ V} \leq V_{OUT} < 1.8\text{ V}$		560		
				$1.8\text{ V} \leq V_{OUT} < 2.5\text{ V}$		450		
				$2.5\text{ V} \leq V_{OUT} < 3.3\text{ V}$		360		
				$3.3\text{ V} \leq V_{OUT} \leq 5.0\text{ V}$		310		
PSRR	Power-supply rejection ratio	$f = 1\text{ kHz}$, $I_{OUT} = 30\text{ mA}$			55		dB	
V_N	Output voltage noise	$BW = 10\text{ Hz}$ to 100 kHz , $V_{OUT} = 0.8\text{ V}$, $I_{OUT} = 30\text{ mA}$			130		μV_{RMS}	
V_{UVLO}	UVLO threshold	V_{IN} rising		1.23	1.3	1.47	V	
		V_{IN} falling		1.0	1.12	1.41		
$V_{UVLO(HYST)}$	UVLO hysteresis	V_{IN} hysteresis			180		mV	

6.5 Electrical Characteristics (continued)

Specified at $T_J = -40^\circ\text{C}$ to $+125^\circ\text{C}$, $V_{IN} = V_{OUT(nom)} + 0.5\text{ V}$ or 2.0 V (whichever is greater), $I_{OUT} = 1\text{ mA}$, $V_{EN} = V_{IN}$, and $C_{IN} = C_{OUT} = 1\text{ }\mu\text{F}$ (unless otherwise noted). Typical values are at $T_J = 25^\circ\text{C}$.

PARAMETER		TEST CONDITIONS	MIN	TYP	MAX	UNIT
$V_{EN(HI)}$	EN pin logic high voltage		1.1			V
$V_{EN(LOW)}$	EN pin logic low voltage				0.3	V
I_{EN}	EN pin leakage current	$V_{EN} = V_{IN} = 6.0\text{ V}$		10		nA
$R_{EN(PULLDOWN)}$	Smart enable pulldown resistor	$V_{EN} = 0.3\text{ V}$		500		K Ω
$R_{PULLDOWN}$	Pulldown resistor	$V_{IN} = 3.3\text{ V}$, device disabled		60		Ω
$T_{SD(shutdown)}$	Thermal shutdown temperature	Shutdown, temperature increasing		170		°C
$T_{SD(reset)}$	Thermal shutdown reset temperature	Reset, temperature decreasing		145		

- (1) $V_{IN} = 2.0\text{ V}$ for $V_{OUT} \leq 1.5\text{ V}$.
- (2) Load Regulation is normalized to the output voltage at $I_{OUT} = 1\text{ mA}$.
- (3) Specified by design
- (4) Dropout is measured by ramping V_{IN} down until $V_{OUT} = V_{OUT(nom)} \times 95\%$, with $I_{OUT} = 200\text{ mA}$.

6.6 Switching Characteristics

Specified at $T_J = -40^\circ\text{C}$ to $+125^\circ\text{C}$, $V_{IN} = V_{OUT(nom)} + 0.5\text{ V}$ or 2.0 V (whichever is greater), $I_{OUT} = 1\text{ mA}$, $V_{EN} = V_{IN}$, and $C_{IN} = C_{OUT} = 1\text{ }\mu\text{F}$ (unless otherwise noted). Typical values are at $T_J = 25^\circ\text{C}$.

PARAMETER		TEST CONDITIONS	MIN	TYP	MAX	UNIT
t_{STR}	Start-up time	From EN assertion to $V_{OUT} = 90\% \times V_{OUT(nom)}$	$0.8\text{ V} \leq V_{OUT} \leq 1.5\text{ V}$	500	800	μs
			$1.5\text{ V} < V_{OUT} \leq 3.0\text{ V}$	750	1200	
			$3.0\text{ V} < V_{OUT} \leq 5.0\text{ V}$	1200	1600	

6.7 Typical Characteristics

at operating temperature range ($T_J = -40^\circ\text{C}$ to $+125^\circ\text{C}$), $V_{IN} = V_{OUT(nom)} + 0.5\text{ V}$ or 2.0 V (whichever is greater), $I_{OUT} = 1\text{ mA}$, $V_{EN} = V_{IN}$, and $C_{IN} = C_{OUT} = 1\text{ }\mu\text{F}$ (unless otherwise noted)

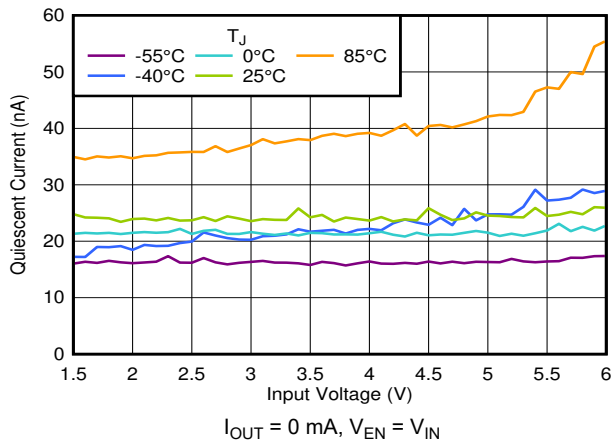

Figure 6-1. I_Q vs V_{IN} and Temperature

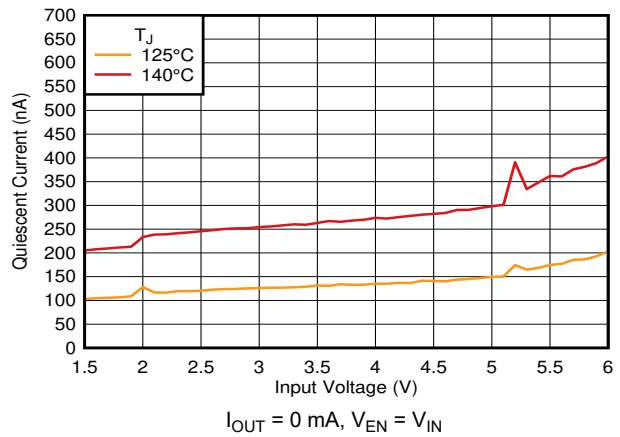

Figure 6-2. I_Q vs V_{IN} and Temperature

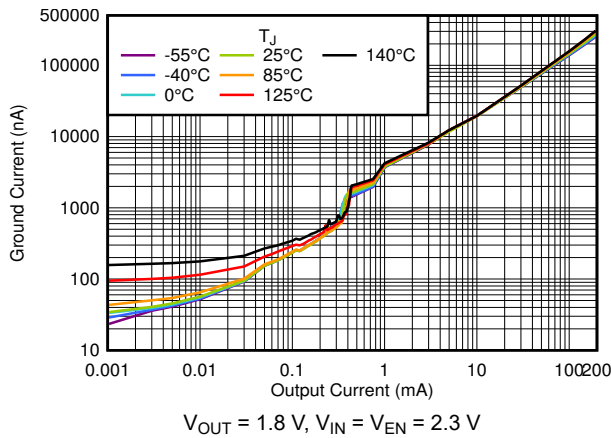

Figure 6-3. I_Q vs I_{OUT} and Temperature up to 200 mA

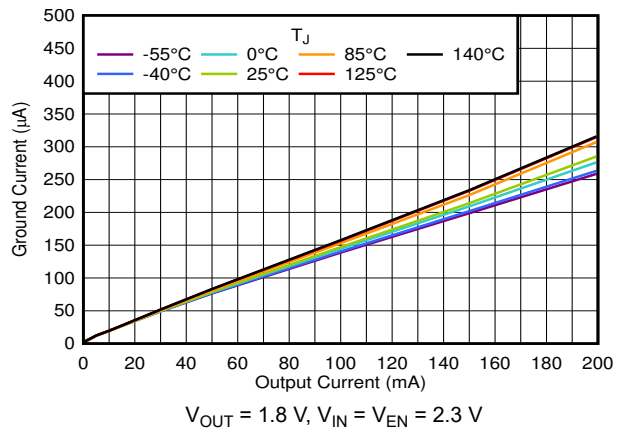

Figure 6-4. I_Q vs I_{OUT} and Temperature Up to 200 mA

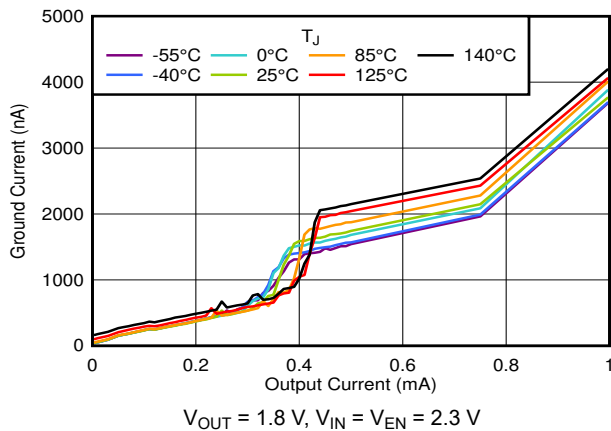

Figure 6-5. I_Q vs I_{OUT} and Temperature Up to 1 mA

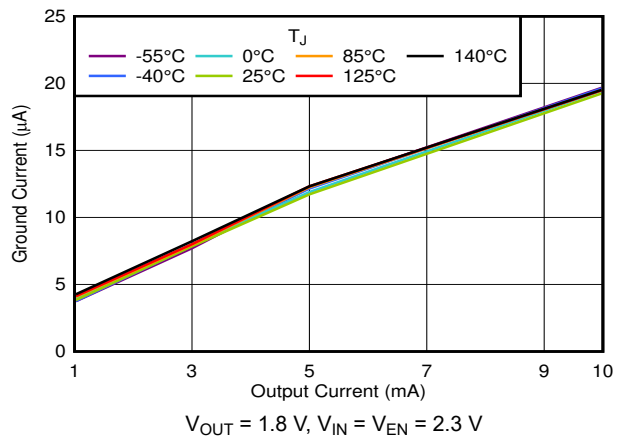

Figure 6-6. I_Q vs I_{OUT} and Temperature for 1 mA to 10 mA

6.7 Typical Characteristics (continued)

at operating temperature range ($T_J = -40^\circ\text{C}$ to $+125^\circ\text{C}$), $V_{IN} = V_{OUT(nom)} + 0.5\text{ V}$ or 2.0 V (whichever is greater), $I_{OUT} = 1\text{ mA}$, $V_{EN} = V_{IN}$, and $C_{IN} = C_{OUT} = 1\text{ }\mu\text{F}$ (unless otherwise noted)

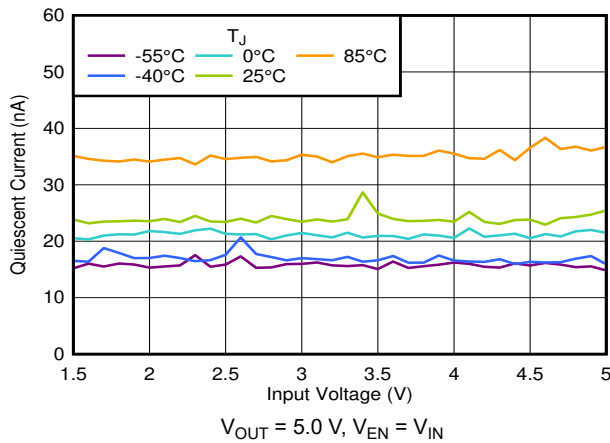

Figure 6-7. I_Q in Dropout vs V_{IN} and Temperature

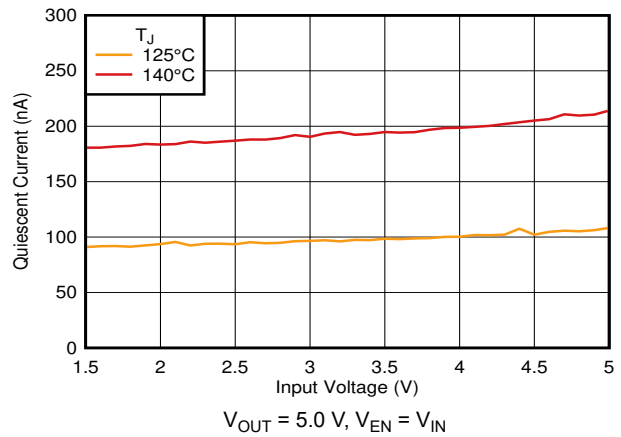

Figure 6-8. I_Q in Dropout vs V_{IN} and Temperature

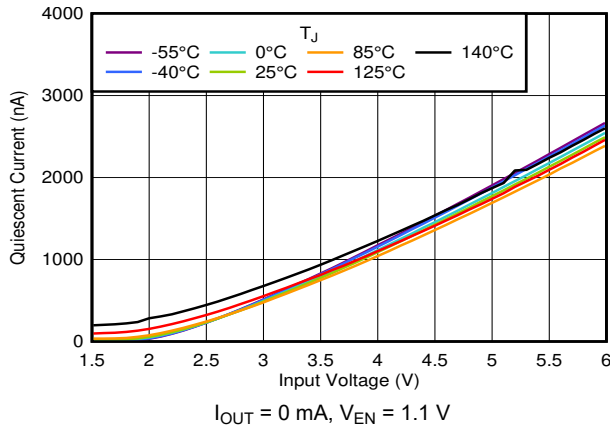

Figure 6-9. I_Q vs V_{IN} and Temperature

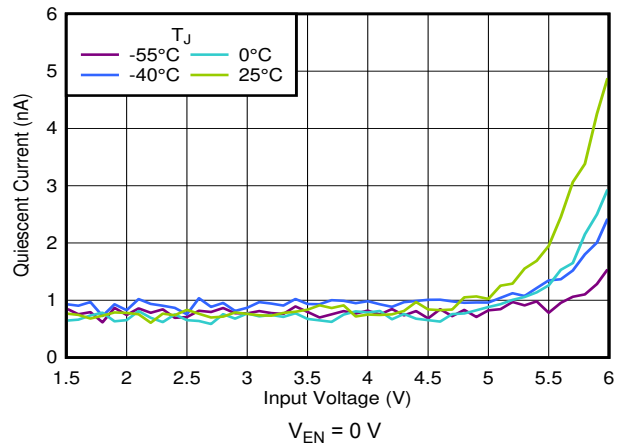

Figure 6-10. I_{SHDN} vs V_{IN} and Temperature

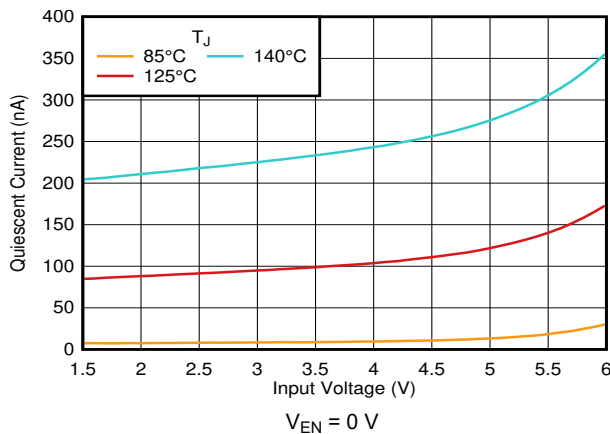

Figure 6-11. I_{SHDN} vs V_{IN} and Temperature

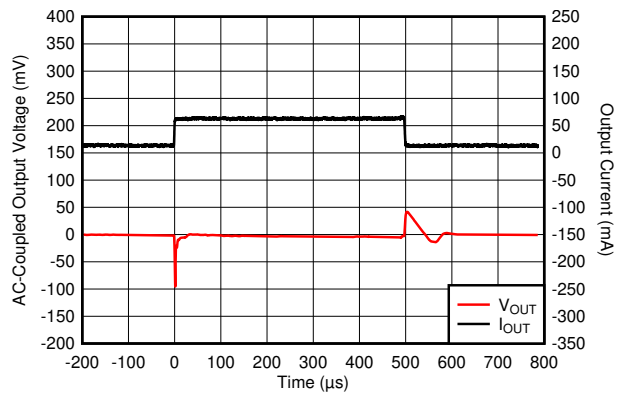
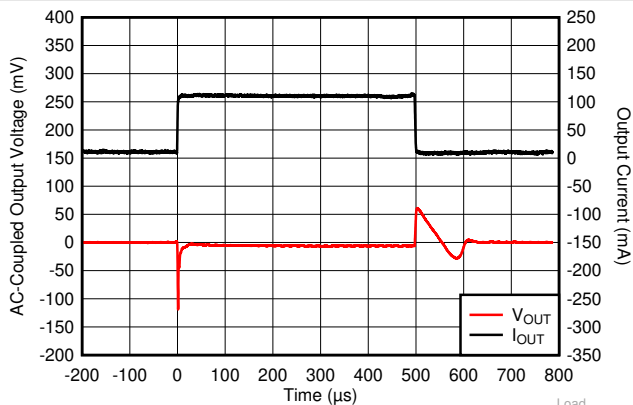

Figure 6-12. I_{OUT} Transient From 1 mA to 50 mA

6.7 Typical Characteristics (continued)

at operating temperature range ($T_J = -40^\circ\text{C}$ to $+125^\circ\text{C}$), $V_{IN} = V_{OUT(nom)} + 0.5\text{ V}$ or 2.0 V (whichever is greater), $I_{OUT} = 1\text{ mA}$, $V_{EN} = V_{IN}$, and $C_{IN} = C_{OUT} = 1\ \mu\text{F}$ (unless otherwise noted)



$V_{OUT} = 1.8\text{ V}$, $V_{IN} = 2.8\text{ V}$, $C_{OUT} = 1\ \mu\text{F}$, $t_r = t_f = 1\ \mu\text{s}$

Figure 6-13. I_{OUT} Transient From 1 mA to 100 mA

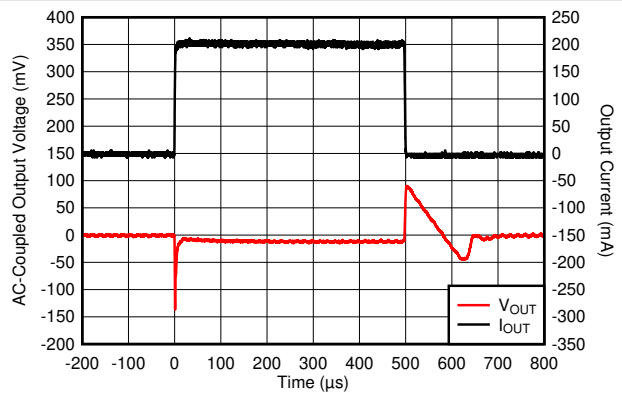

$V_{OUT} = 1.8\text{ V}$, $V_{IN} = 2.8\text{ V}$, $C_{OUT} = 1\ \mu\text{F}$, $t_r = t_f = 1\ \mu\text{s}$

Figure 6-14. I_{OUT} Transient From 1 mA to 200 mA

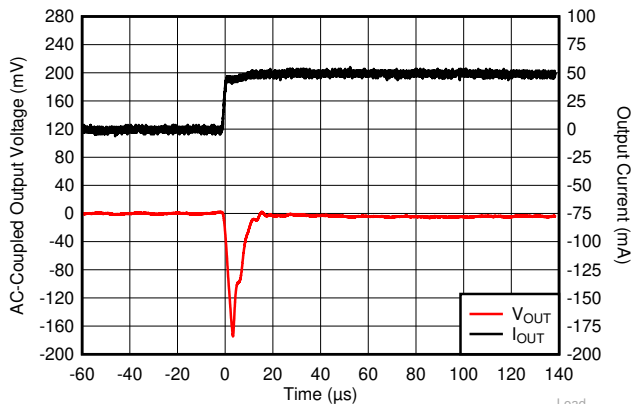

$V_{OUT} = 1.8\text{ V}$, $V_{IN} = 2.8\text{ V}$, $C_{OUT} = 1\ \mu\text{F}$, $t_r = t_f = 1\ \mu\text{s}$

Figure 6-15. I_{OUT} Transient From 0 mA to 50 mA

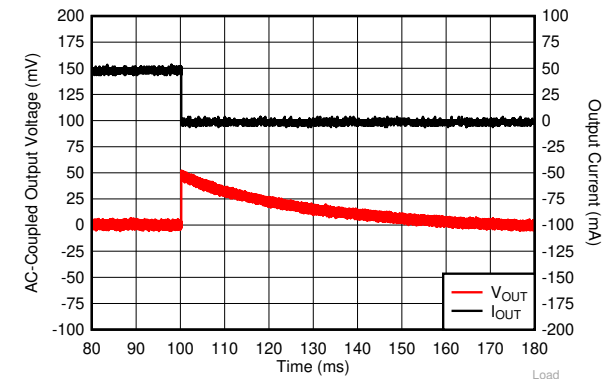

$V_{OUT} = 1.8\text{ V}$, $V_{IN} = 2.8\text{ V}$, $C_{OUT} = 1\ \mu\text{F}$, $t_r = t_f = 1\ \mu\text{s}$

Figure 6-16. I_{OUT} Transient From 50 mA to 0 mA

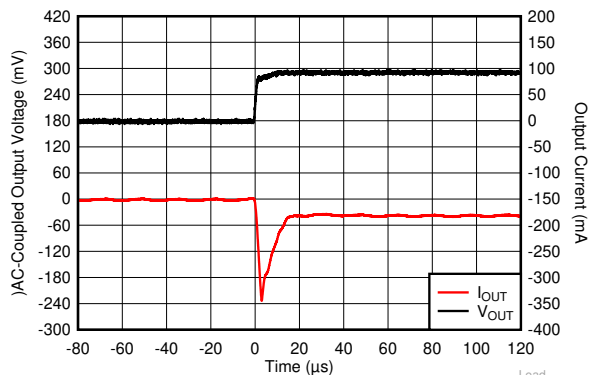

$V_{OUT} = 1.8\text{ V}$, $V_{IN} = 2.8\text{ V}$, $C_{OUT} = 1\ \mu\text{F}$, $t_r = t_f = 1\ \mu\text{s}$

Figure 6-17. I_{OUT} Transient From 0 mA to 100 mA

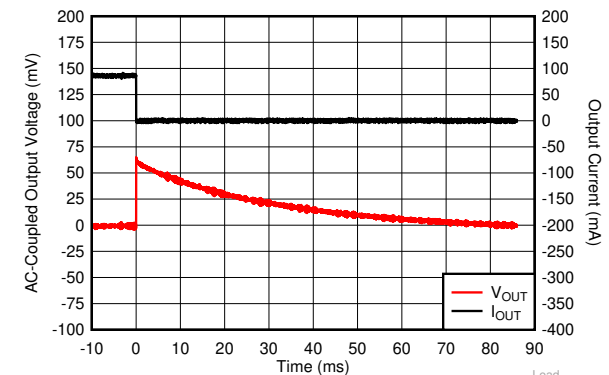

$V_{OUT} = 1.8\text{ V}$, $V_{IN} = 2.8\text{ V}$, $C_{OUT} = 1\ \mu\text{F}$, $t_r = t_f = 1\ \mu\text{s}$

Figure 6-18. I_{OUT} Transient From 100 mA to 0 mA

6.7 Typical Characteristics (continued)

at operating temperature range ($T_J = -40^{\circ}\text{C}$ to $+125^{\circ}\text{C}$), $V_{IN} = V_{OUT(nom)} + 0.5\text{ V}$ or 2.0 V (whichever is greater), $I_{OUT} = 1\text{ mA}$, $V_{EN} = V_{IN}$, and $C_{IN} = C_{OUT} = 1\text{ }\mu\text{F}$ (unless otherwise noted)

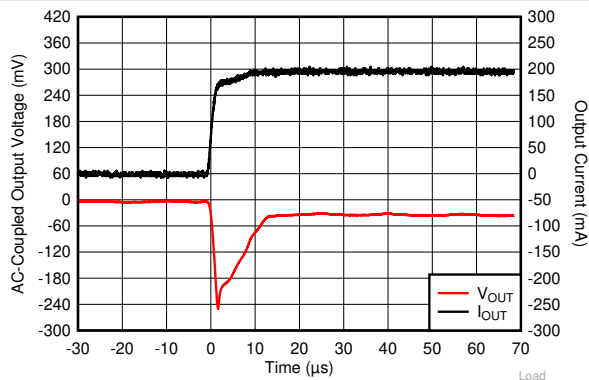

$V_{OUT} = 1.8\text{ V}$, $V_{IN} = 2.8\text{ V}$, $C_{OUT} = 1\text{ }\mu\text{F}$, $t_r = t_f = 1\text{ }\mu\text{s}$

Figure 6-19. I_{OUT} Transient From 0 mA to 200 mA

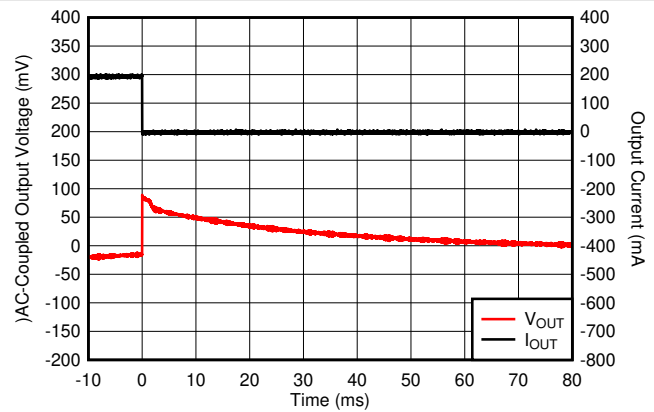

$V_{OUT} = 1.8\text{ V}$, $V_{IN} = 2.8\text{ V}$, $C_{OUT} = 1\text{ }\mu\text{F}$, $t_r = t_f = 1\text{ }\mu\text{s}$

Figure 6-20. I_{OUT} Transient From 200 mA to 0 mA

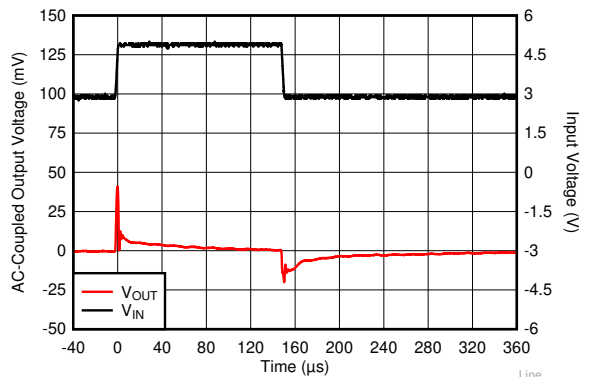

$V_{OUT} = 1.8\text{ V}$, $I_{OUT} = 200\text{ mA}$, $C_{OUT} = 1\text{ }\mu\text{F}$, slew rate = $1\text{ V}/\mu\text{s}$

Figure 6-21. V_{IN} Transient From 2.8 V to 4.8 V

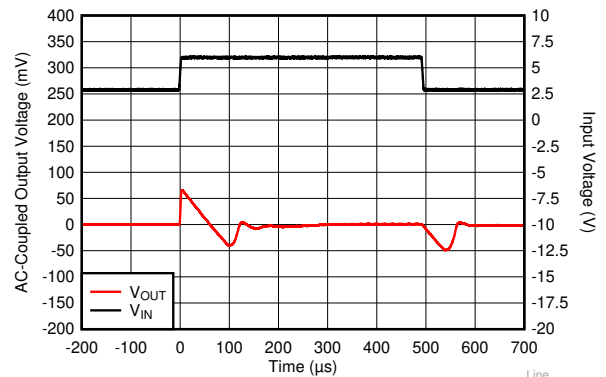

$V_{OUT} = 1.8\text{ V}$, $I_{OUT} = 1\text{ mA}$, $C_{OUT} = 1\text{ }\mu\text{F}$, slew rate = $1\text{ V}/\mu\text{s}$

Figure 6-22. V_{IN} Transient From 2.8 V to 6.0 V

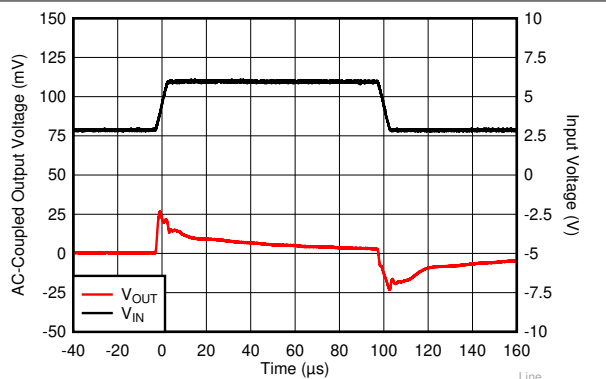

$V_{OUT} = 1.8\text{ V}$, $I_{OUT} = 200\text{ mA}$, $C_{OUT} = 1\text{ }\mu\text{F}$, slew rate = $1\text{ V}/\mu\text{s}$

Figure 6-23. V_{IN} Transient From 2.8 V to 6.0 V

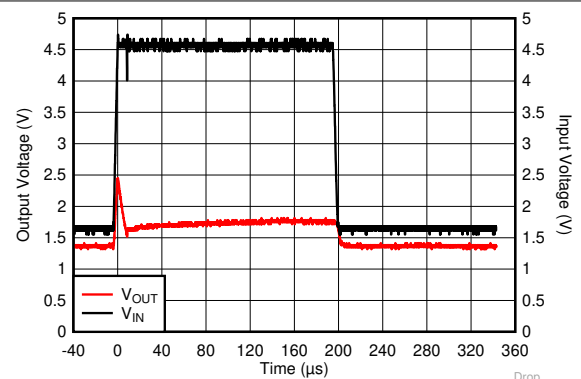

$V_{OUT} = 1.8\text{ V}$, $I_{OUT} = 100\text{ mA}$, $C_{OUT} = 1\text{ }\mu\text{F}$, slew rate = $1\text{ V}/\mu\text{s}$

Figure 6-24. V_{IN} Transient From 1.5 V to 4.5 V

6.7 Typical Characteristics (continued)

at operating temperature range ($T_J = -40^\circ\text{C}$ to $+125^\circ\text{C}$), $V_{IN} = V_{OUT(nom)} + 0.5\text{ V}$ or 2.0 V (whichever is greater), $I_{OUT} = 1\text{ mA}$, $V_{EN} = V_{IN}$, and $C_{IN} = C_{OUT} = 1\text{ }\mu\text{F}$ (unless otherwise noted)

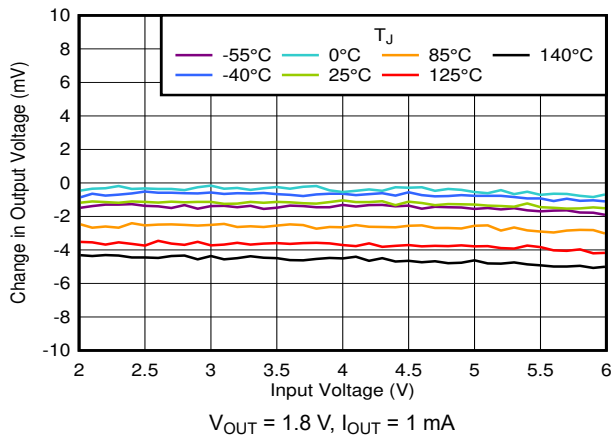

Figure 6-25. Line Regulation vs V_{IN} and Temperature

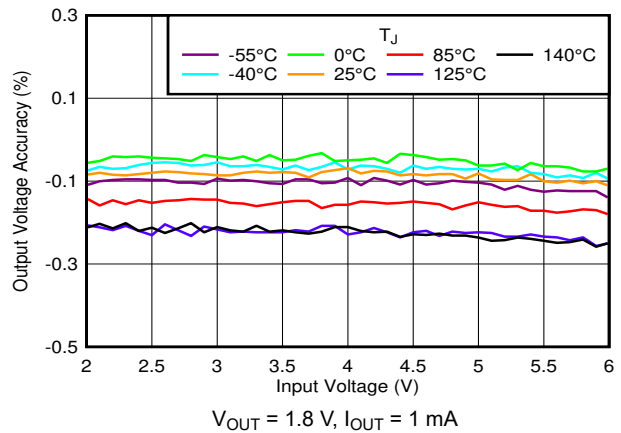

Figure 6-26. Output Accuracy vs V_{IN} and Temperature

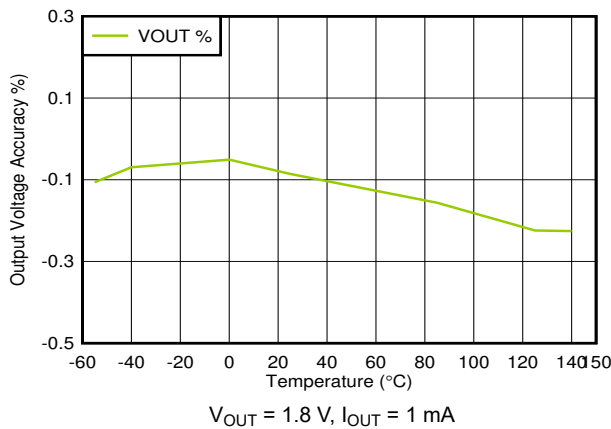

Figure 6-27. Output Accuracy vs Temperature

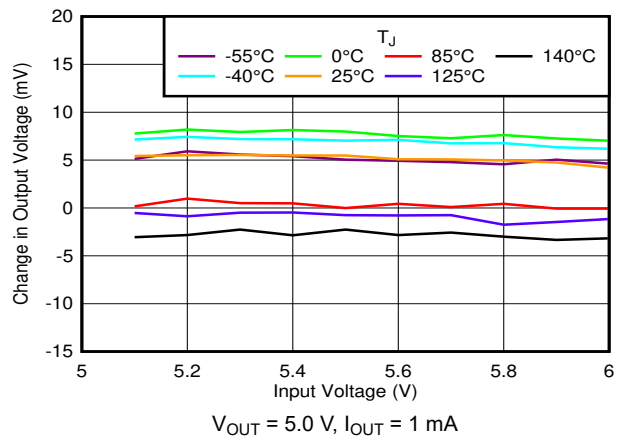

Figure 6-28. Line Regulation vs V_{IN} and Temperature

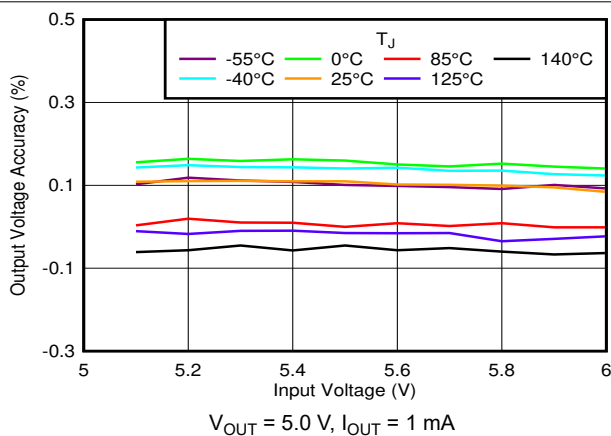

Figure 6-29. Output Accuracy vs V_{IN} and Temperature

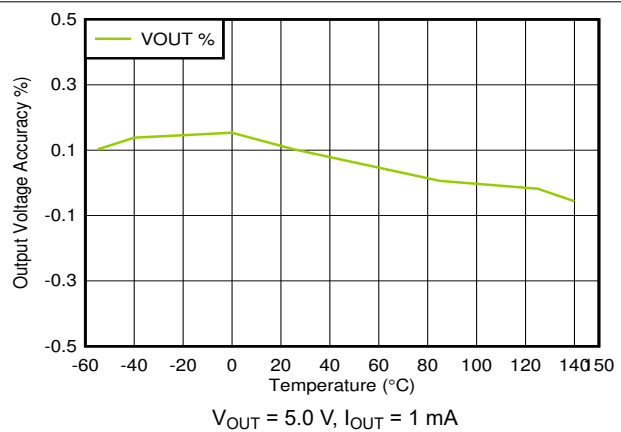

Figure 6-30. Output Accuracy vs Temperature

6.7 Typical Characteristics (continued)

at operating temperature range ($T_J = -40^\circ\text{C}$ to $+125^\circ\text{C}$), $V_{IN} = V_{OUT(nom)} + 0.5\text{ V}$ or 2.0 V (whichever is greater), $I_{OUT} = 1\text{ mA}$, $V_{EN} = V_{IN}$, and $C_{IN} = C_{OUT} = 1\text{ }\mu\text{F}$ (unless otherwise noted)

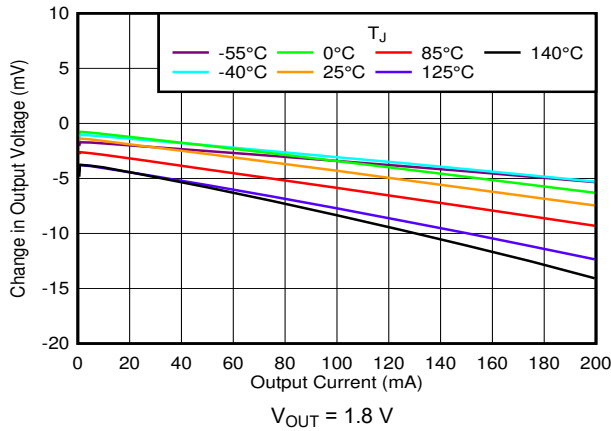

Figure 6-31. Load Regulation vs V_{IN} and Temperature

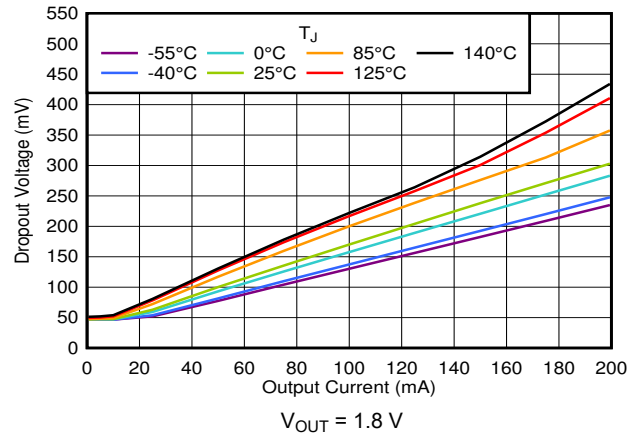

Figure 6-32. Dropout vs I_{OUT} and Temperature

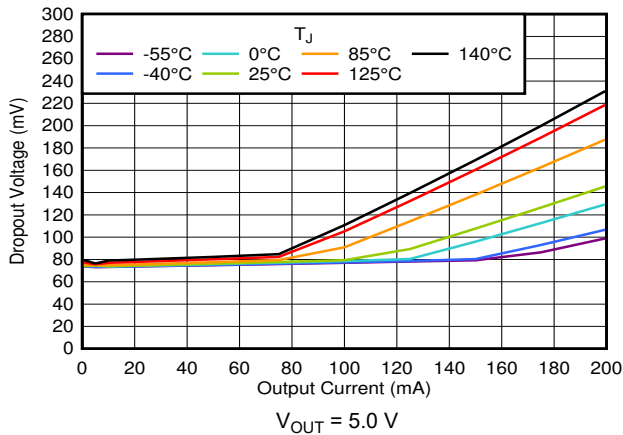

Figure 6-33. Dropout vs I_{OUT} and Temperature

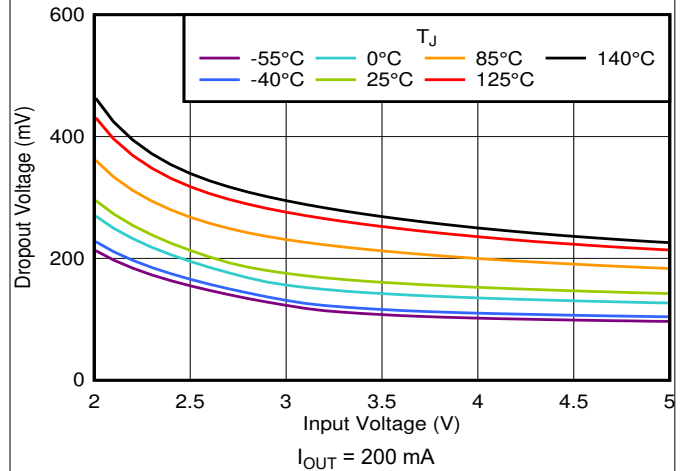

Figure 6-34. Dropout vs V_{IN} and Temperature

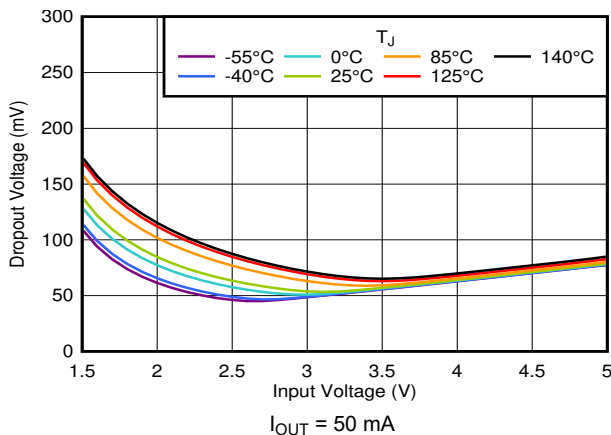

Figure 6-35. Dropout vs V_{IN} and Temperature

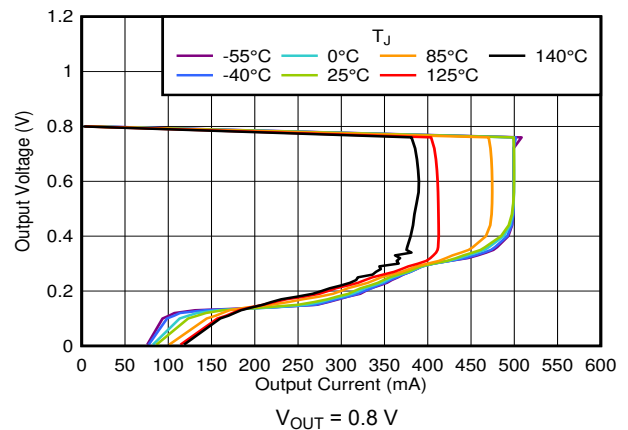

Figure 6-36. Foldback Current Limit vs I_{OUT} and Temperature

6.7 Typical Characteristics (continued)

at operating temperature range ($T_J = -40^\circ\text{C}$ to $+125^\circ\text{C}$), $V_{IN} = V_{OUT(nom)} + 0.5\text{ V}$ or 2.0 V (whichever is greater), $I_{OUT} = 1\text{ mA}$, $V_{EN} = V_{IN}$, and $C_{IN} = C_{OUT} = 1\text{ }\mu\text{F}$ (unless otherwise noted)

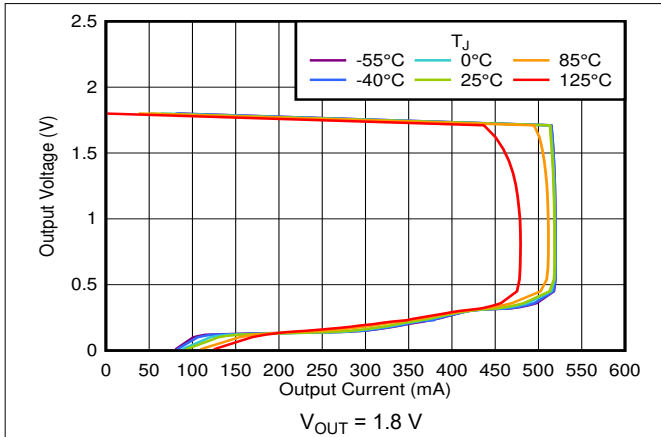

Figure 6-37. Foldback Current Limit vs I_{OUT} and Temperature

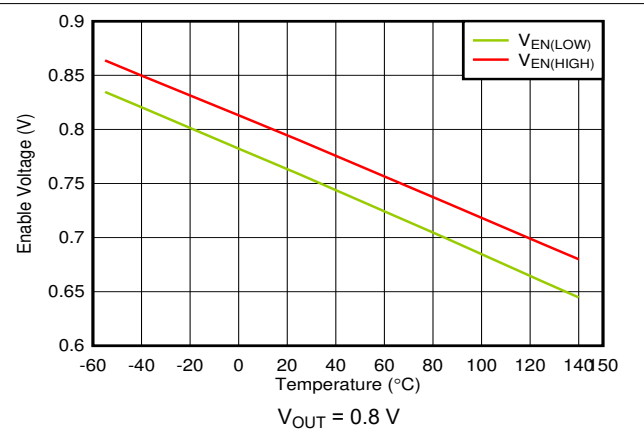

Figure 6-38. EN High and Low Threshold vs Temperature

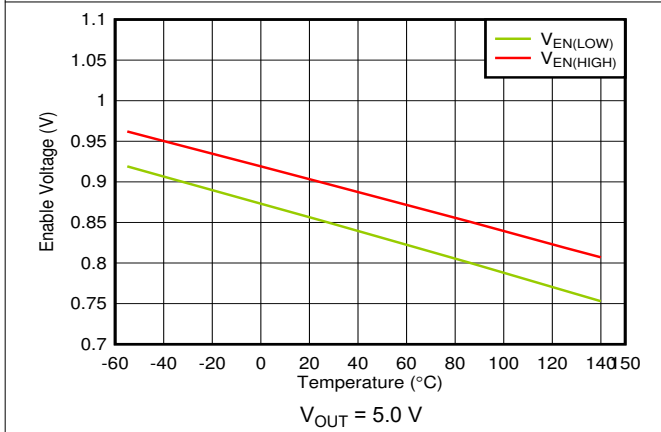

Figure 6-39. EN High and Low Threshold vs Temperature

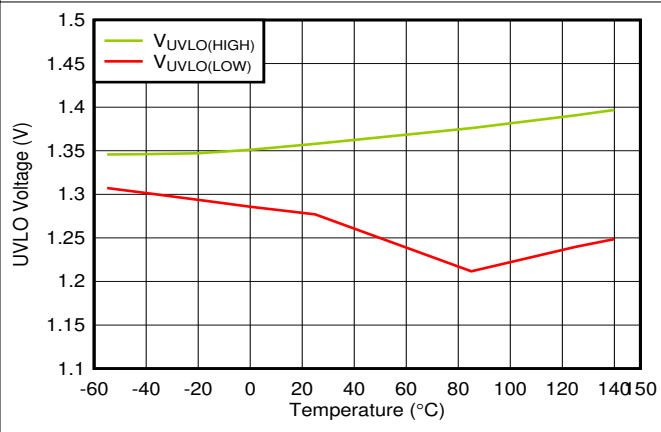

Figure 6-40. UVLO Rising and Falling Threshold vs Temperature

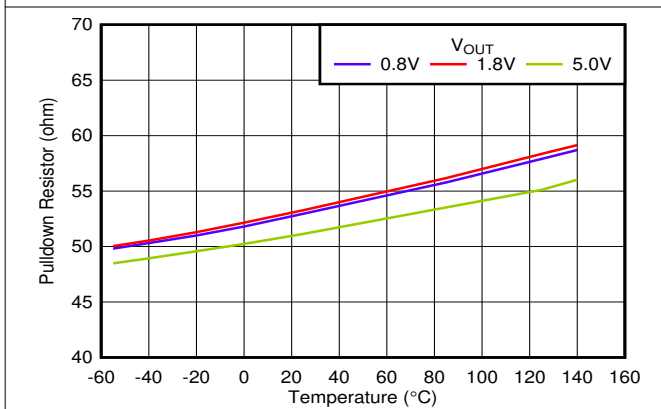

Figure 6-41. Pulldown Resistor vs Temperature and V_{OUT}

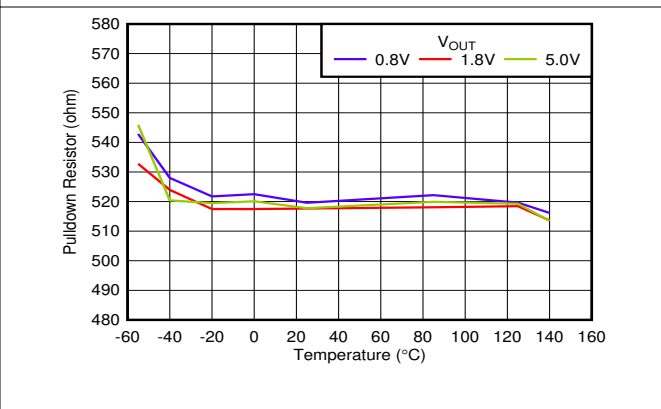
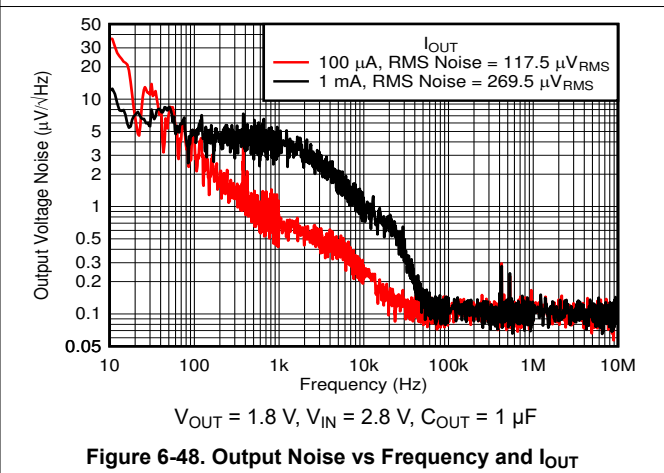
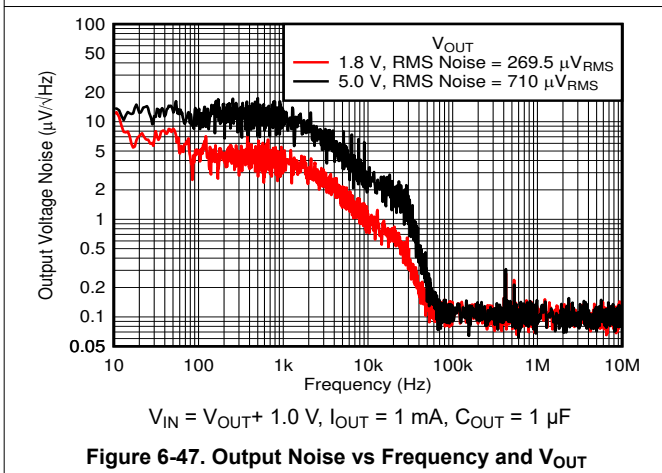
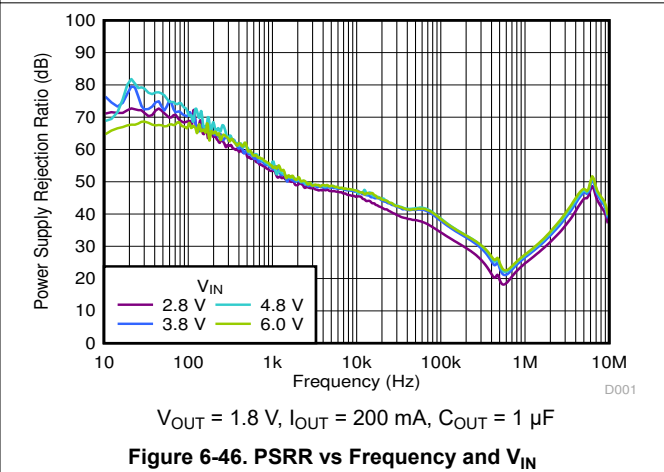
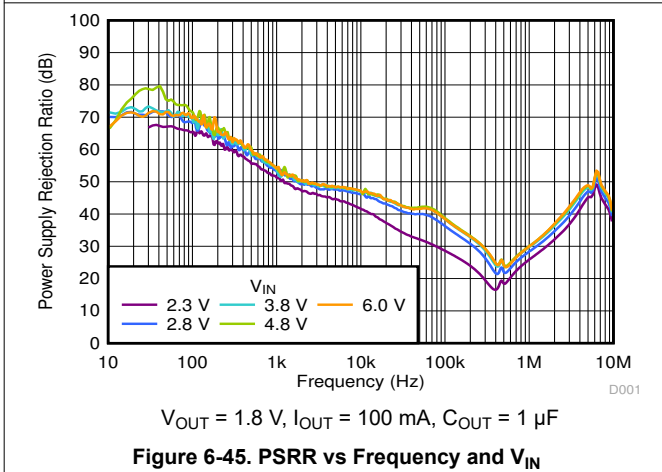
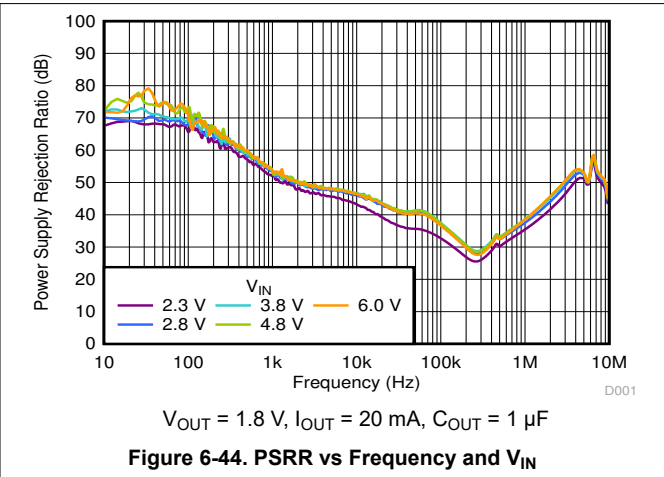
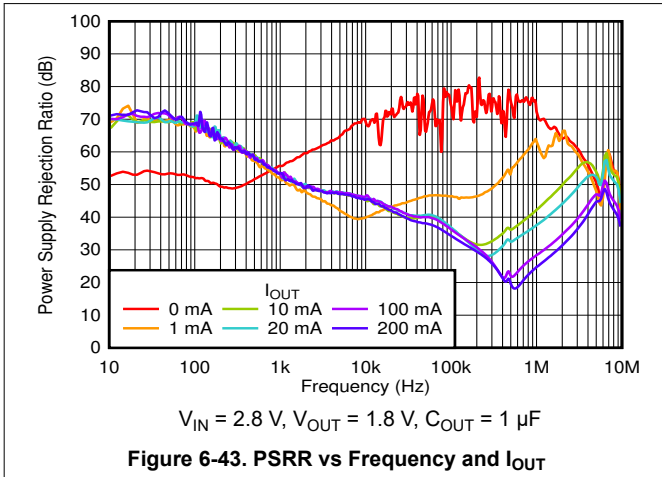

Figure 6-42. Smart Enable Pulldown Resistor vs Temperature and V_{OUT}

6.7 Typical Characteristics (continued)

at operating temperature range ($T_J = -40^{\circ}\text{C}$ to $+125^{\circ}\text{C}$), $V_{IN} = V_{OUT(nom)} + 0.5\text{ V}$ or 2.0 V (whichever is greater), $I_{OUT} = 1\text{ mA}$, $V_{EN} = V_{IN}$, and $C_{IN} = C_{OUT} = 1\text{ }\mu\text{F}$ (unless otherwise noted)



6.7 Typical Characteristics (continued)

at operating temperature range ($T_J = -40^{\circ}\text{C}$ to $+125^{\circ}\text{C}$), $V_{IN} = V_{OUT(nom)} + 0.5\text{ V}$ or 2.0 V (whichever is greater), $I_{OUT} = 1\text{ mA}$, $V_{EN} = V_{IN}$, and $C_{IN} = C_{OUT} = 1\text{ }\mu\text{F}$ (unless otherwise noted)

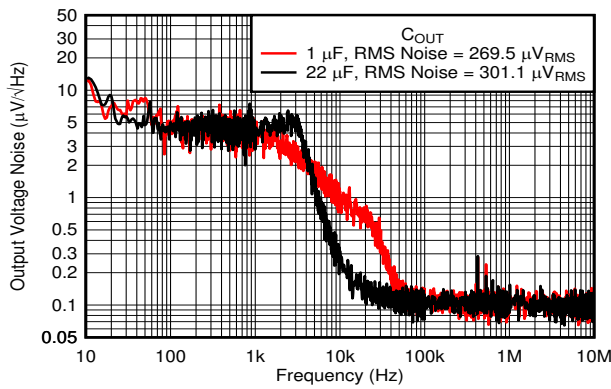

$V_{OUT} = 1.8\text{ V}$, $V_{IN} = 2.8\text{ V}$, $I_{OUT} = 1\text{ mA}$

Figure 6-49. Output Noise vs Frequency and C_{OUT}

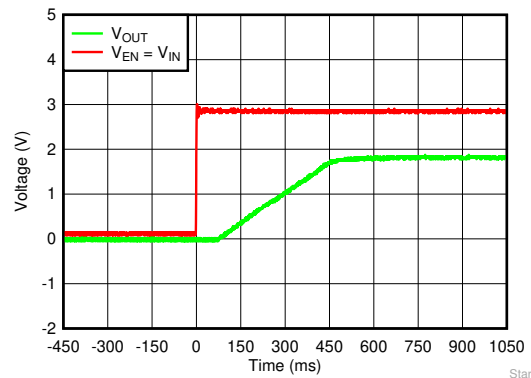

$V_{OUT} = 1.8\text{ V}$, $I_{OUT} = 200\text{ mA}$, $C_{OUT} = 1\text{ }\mu\text{F}$

Figure 6-50. Startup With $V_{EN} = V_{IN}$

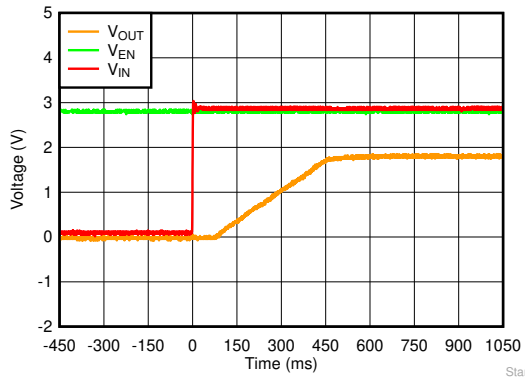

$V_{OUT} = 1.8\text{ V}$, $I_{OUT} = 200\text{ mA}$, $C_{OUT} = 1\text{ }\mu\text{F}$

Figure 6-51. Startup With V_{EN} Before V_{IN}

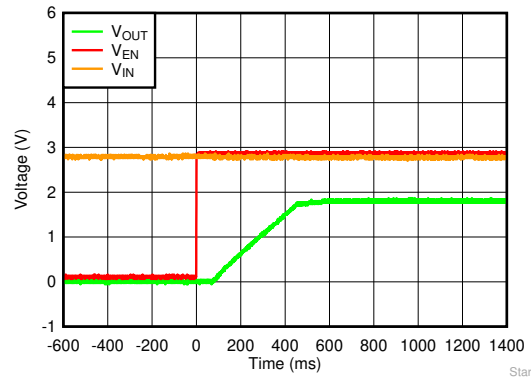

$V_{OUT} = 1.8\text{ V}$, $I_{OUT} = 200\text{ mA}$, $C_{OUT} = 1\text{ }\mu\text{F}$

Figure 6-52. Startup With V_{EN} After V_{IN}

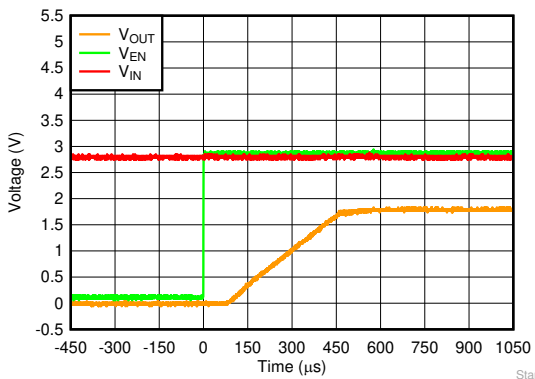

$V_{OUT} = 1.8\text{ V}$, $I_{OUT} = 0\text{ mA}$, $C_{OUT} = 1\text{ }\mu\text{F}$

Figure 6-53. Startup With V_{EN} After V_{IN}

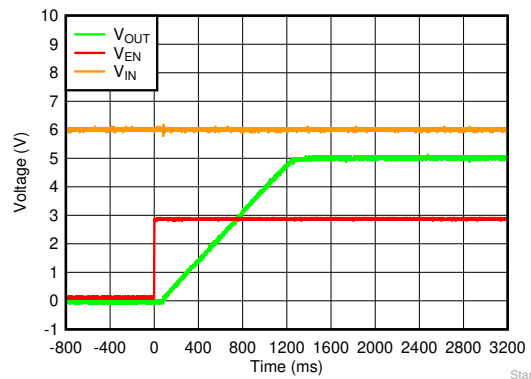

$V_{OUT} = 5.0\text{ V}$, $I_{OUT} = 200\text{ mA}$, $C_{OUT} = 1\text{ }\mu\text{F}$

Figure 6-54. Startup With V_{EN} After V_{IN}

6.7 Typical Characteristics (continued)

at operating temperature range ($T_J = -40^\circ\text{C}$ to $+125^\circ\text{C}$), $V_{IN} = V_{OUT(nom)} + 0.5\text{ V}$ or 2.0 V (whichever is greater), $I_{OUT} = 1\text{ mA}$, $V_{EN} = V_{IN}$, and $C_{IN} = C_{OUT} = 1\text{ }\mu\text{F}$ (unless otherwise noted)

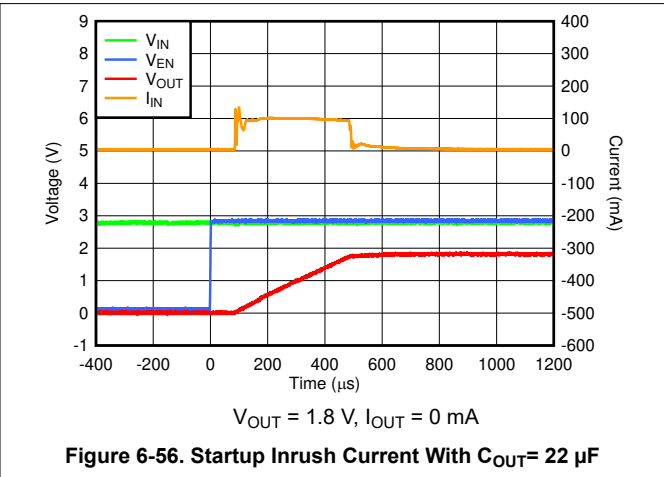
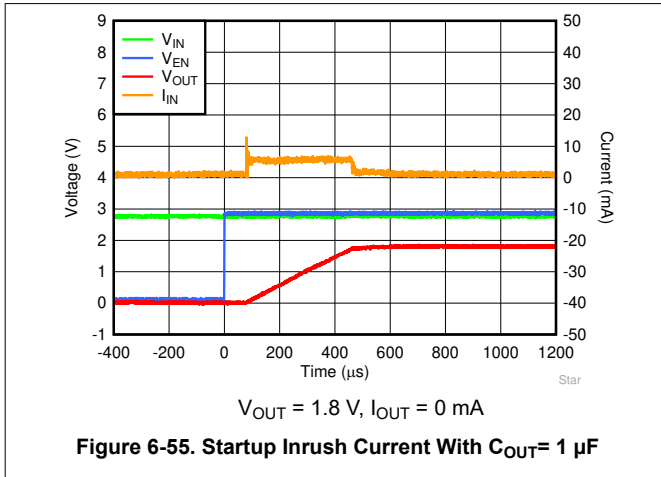

7 Detailed Description

7.1 Overview

The TPS7A02 is an ultra-low I_Q linear voltage regulator that is optimized for excellent transient performance. These characteristics make the device ideal for most battery-powered applications.

This low-dropout linear regulator (LDO) offers active discharge, foldback current limit, shutdown, and thermal protection capability.

7.2 Functional Block Diagram

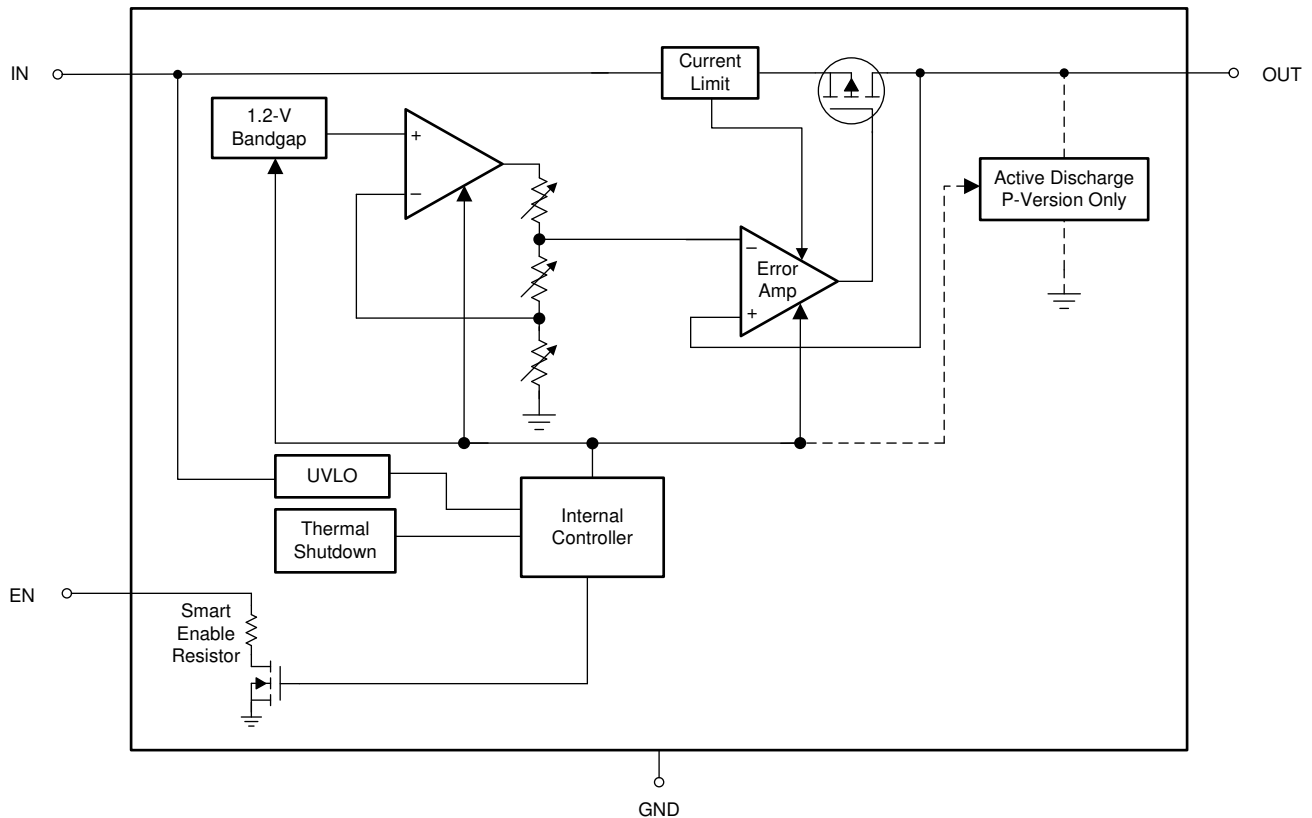

7.3 Feature Description

7.3.1 Excellent Transient Response

The TPS7A02 includes several innovative circuits to ensure excellent transient response. Dynamic biasing increases the I_Q for a short duration during transients to extend the closed-loop bandwidth and improve the output response time to transients.

Adaptive biasing increases the I_Q as the DC load current increases, extending the bandwidth of the loop. The response time across the output voltage range is constant because a buffered reference topology is used, which keeps the control loop in unity gain at any output voltage.

These features give the device a wide loop bandwidth during transients that ensures excellent transient response while maintaining low I_Q in steady-state conditions.

7.3.2 Active Discharge (P-Version Only)

The device has an internal pulldown MOSFET that connects a $R_{PULLDOWN}$ resistor to ground when the device is disabled to actively discharge the output voltage. The active discharge circuit is activated by the enable pin or by the undervoltage lockout (UVLO).

Do not rely on the active discharge circuit for discharging a large amount of output capacitance after the input supply has collapsed because reverse current can possibly flow from the output to the input. This reverse current flow can cause damage to the device. Limit reverse current to no more than 5% of the device rated current for a short period of time.

7.3.3 Low I_Q in Dropout

In most LDOs the I_Q significantly increases when the device is placed into dropout, which is especially true for low I_Q LDOs. The TPS7A02 helps to reduce the battery discharge by detecting when the device is operating in dropout conditions and maintaining a low I_Q .

7.3.4 Smart Enable

The enable (EN) input polarity is active high. The output voltage is enabled when the voltage of the enable input is greater than $V_{EN(HI)}$ and disabled when the enable input voltage is less than $V_{EN(LOW)}$. If independent control of the output voltage is not needed, connect EN to IN.

This device has a smart enable circuit to reduce quiescent current. When the voltage on the enable pin is driven above $V_{EN(HI)}$, as listed in the *Electrical Characteristics* table, the device is enabled and the smart enable internal pulldown resistor ($R_{EN(PULLDOWN)}$) is disconnected. When the enable pin is floating, the $R_{EN(PULLDOWN)}$ is connected and pulls the enable pin low to disable the device. The $R_{EN(PULLDOWN)}$ value is listed in the *Electrical Characteristics* table.

This device has an internal pulldown circuit that activates when the device is disabled to actively discharge the output voltage.

7.3.5 Dropout Voltage

Dropout voltage (V_{DO}) is defined as the input voltage minus the output voltage ($V_{IN} - V_{OUT}$) at the rated output current (I_{RATED}), where the pass transistor is fully on. I_{RATED} is the maximum I_{OUT} listed in the *Recommended Operating Conditions* table. The pass transistor is in the ohmic or triode region of operation, and acts as a switch. The dropout voltage indirectly specifies a minimum input voltage greater than the nominal programmed output voltage at which the output voltage is expected to stay in regulation. If the input voltage falls to less than the nominal output regulation, then the output voltage falls as well.

For a CMOS regulator, the dropout voltage is determined by the drain-source on-state resistance ($R_{DS(ON)}$) of the pass transistor. Therefore, if the linear regulator operates at less than the rated current, the dropout voltage for that current scales accordingly. The following equation calculates the $R_{DS(ON)}$ of the device.

$$R_{DS(ON)} = \frac{V_{DO}}{I_{RATED}} \quad (1)$$

7.3.6 Foldback Current Limit

The device has an internal current limit circuit that protects the regulator during transient high-load current faults or shorting events. The current limit is a hybrid brick-wall-foldback scheme. The current limit transitions from a brick-wall scheme to a foldback scheme at the foldback voltage ($V_{FOLDBACK}$). In a high-load current fault with the output voltage above $V_{FOLDBACK}$, the brick-wall scheme limits the output current to the current limit (I_{CL}). When the voltage drops below $V_{FOLDBACK}$, a foldback current limit activates that scales back the current as the output voltage approaches GND. When the output is shorted, the device supplies a typical current called the short-circuit current limit (I_{SC}). I_{CL} and I_{SC} are listed in the *Electrical Characteristics* table.

For this device, $V_{FOLDBACK} = 0.5\text{ V}$.

The output voltage is not regulated when the device is in current limit. When a current limit event occurs, the device begins to heat up because of the increase in power dissipation. When the device is in brick-wall current limit, the pass transistor dissipates power $[(V_{IN} - V_{OUT}) \times I_{CL}]$. When the device output is shorted and the output is below $V_{FOLDBACK}$, the pass transistor dissipates power $[(V_{IN} - V_{OUT}) \times I_{SC}]$. If thermal shutdown is triggered, the device turns off. After the device cools down, the internal thermal shutdown circuit turns the device back on. If the output current fault condition continues, the device cycles between current limit and thermal shutdown. For more information on current limits, see the [Know Your Limits application report](#).

Figure 7-1 shows a diagram of the foldback current limit.

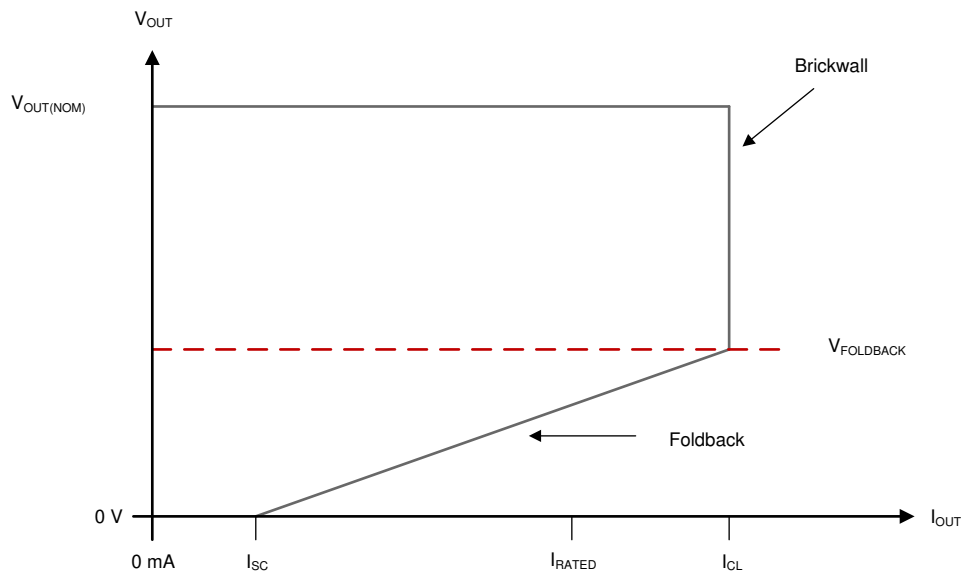

Figure 7-1. Foldback Current Limit

7.3.7 Undervoltage Lockout (UVLO)

The device has an independent undervoltage lockout (UVLO) circuit that monitors the input voltage, allowing a controlled and consistent turn on and off of the output voltage. To prevent the device from turning off if the input drops during turn on, the UVLO has hysteresis as specified in the *Electrical Characteristics* table.

7.3.8 Thermal Shutdown

The device contains a thermal shutdown protection circuit to disable the device when the junction temperature (T_J) of the pass transistor rises to $T_{SD(\text{shutdown})}$ (typical). Thermal shutdown hysteresis assures that the device resets (turns on) when the temperature falls to $T_{SD(\text{reset})}$ (typical).

The thermal time-constant of the semiconductor die is fairly short, thus the device may cycle on and off when thermal shutdown is reached until power dissipation is reduced. Power dissipation during start up can be high from large $V_{IN} - V_{OUT}$ voltage drops across the device or from high inrush currents charging large output capacitors. Under some conditions, the thermal shutdown protection disables the device before start up completes.

For reliable operation, limit the junction temperature to the maximum listed in the *Recommended Operating Conditions* table. Operation above this maximum temperature causes the device to exceed operational specifications. Although the internal protection circuitry of the device is designed to protect against thermal overall conditions, this circuitry is not intended to replace proper heat sinking. Continuously running the device into thermal shutdown or above the maximum recommended junction temperature reduces long-term reliability.

7.4 Device Functional Modes

7.4.1 Device Functional Mode Comparison

Table 7-1 shows the conditions that lead to the different modes of operation. See the *Electrical Characteristics* table for parameter values.

Table 7-1. Device Functional Mode Comparison

OPERATING MODE	PARAMETER			
	V_{IN}	V_{EN}	I_{OUT}	T_J
Normal operation	$V_{IN} > V_{OUT(nom)} + V_{DO}$ and $V_{IN} > V_{IN(min)}$	$V_{EN} > V_{EN(HI)}$	$I_{OUT} < I_{OUT(max)}$	$T_J < T_{SD(shutdown)}$
Dropout operation	$V_{IN(min)} < V_{IN} < V_{OUT(nom)} + V_{DO}$	$V_{EN} > V_{EN(HI)}$	$I_{OUT} < I_{OUT(max)}$	$T_J < T_{SD(shutdown)}$
Disabled (any true condition disables the device)	$V_{IN} < V_{UVLO}$	$V_{EN} < V_{EN(LOW)}$	Not applicable	$T_J > T_{SD(shutdown)}$

7.4.2 Normal Operation

The device regulates to the nominal output voltage when the following conditions are met:

- The input voltage is greater than the nominal output voltage plus the dropout voltage ($V_{OUT(nom)} + V_{DO}$)
- The output current is less than the current limit ($I_{OUT} < I_{CL}$)
- The device junction temperature is less than the thermal shutdown temperature ($T_J < T_{SD}$)
- The enable voltage has previously exceeded the enable rising threshold voltage and has not yet decreased to less than the enable falling threshold

7.4.3 Dropout Operation

If the input voltage is lower than the nominal output voltage plus the specified dropout voltage, but all other conditions are met for normal operation, the device operates in dropout mode. In this mode, the output voltage tracks the input voltage. During this mode, the transient performance of the device becomes significantly degraded because the pass transistor is in the ohmic or triode region, and acts as a switch. Line or load transients in dropout can result in large output-voltage deviations.

When the device is in a steady dropout state (defined as when the device is in dropout, $V_{IN} < V_{OUT(NOM)} + V_{DO}$, directly after being in a normal regulation state, but *not* during start-up), the pass transistor is driven into the ohmic or triode region. When the input voltage returns to a value greater than or equal to the nominal output voltage plus the dropout voltage ($V_{OUT(NOM)} + V_{DO}$), the output voltage can overshoot for a short period of time while the device pulls the pass transistor back into the linear region.

7.4.4 Disabled

The output of the device can be shutdown by forcing the voltage of the enable pin to less than the maximum EN pin low-level input voltage (see the *Electrical Characteristics* table). When disabled, the pass transistor is turned off, internal circuits are shutdown, and the output voltage is actively discharged to ground by an internal discharge circuit from the output to ground.

8 Application and Implementation

Note

Information in the following applications sections is not part of the TI component specification, and TI does not warrant its accuracy or completeness. TI's customers are responsible for determining suitability of components for their purposes, as well as validating and testing their design implementation to confirm system functionality.

8.1 Application Information

8.1.1 Recommended Capacitor Types

The device is designed to be stable using low equivalent series resistance (ESR) ceramic capacitors at the input and output. Multilayer ceramic capacitors have become the industry standard for these types of applications and are recommended, but must be used with good judgment. Ceramic capacitors that employ X7R-, X5R-, and C0G-rated dielectric materials provide relatively good capacitive stability across temperature, whereas the use of Y5V-rated capacitors is discouraged because of large variations in capacitance.

Regardless of the ceramic capacitor type selected, the effective capacitance varies with operating voltage and temperature. As a rule of thumb, expect the effective capacitance to decrease by as much as 50%. The input and output capacitors recommended in the *Recommended Operating Conditions* table account for an effective capacitance of approximately 50% of the nominal value.

8.1.2 Input and Output Capacitor Requirements

Although an input capacitor is not required for stability, good analog design practice is to connect a capacitor from IN to GND. This capacitor counteracts reactive input sources and improves transient response, input ripple, and PSRR. An input capacitor is recommended if the source impedance is more than 0.5 Ω . A higher value capacitor may be necessary if large, fast rise-time load or line transients are anticipated or if the device is located several inches from the input power source.

Dynamic performance of the device is improved with the use of an output capacitor. Use an output capacitor within the range specified in the *Recommended Operating Conditions* table for stability.

8.1.3 Load Transient Response

The load-step transient response is the output voltage response by the LDO to a step in load current, whereby output voltage regulation is maintained. There are two key transitions during a load transient response: the transition from a light to a heavy load and the transition from a heavy to a light load. The regions shown in [Figure 8-1](#) are broken down as follows. Regions A, E, and H are where the output voltage is in steady-state.

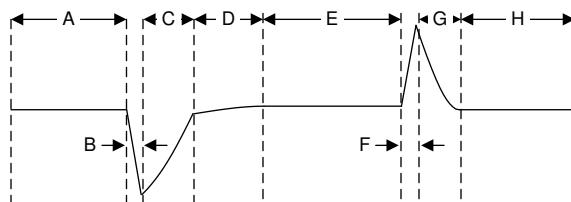

Figure 8-1. Load Transient Waveform

During transitions from a light load to a heavy load, the:

- Initial voltage dip is a result of the depletion of the output capacitor charge and parasitic impedance to the output capacitor (region B)
- Recovery from the dip results from the LDO increasing the sourcing current, and leads to output voltage regulation (region C)

During transitions from a heavy load to a light load, the:

- Initial voltage rise results from the LDO sourcing a large current, and leads to the output capacitor charge to increase (region F)
- Recovery from the rise results from the LDO decreasing the sourcing current in combination with the load discharging the output capacitor (region G)

A larger output capacitance reduces the peaks during a load transient but slows down the response time of the device. A larger DC load also reduces the peaks because the amplitude of the transition is lowered and a higher current discharge path is provided for the output capacitor.

8.1.4 Undervoltage Lockout (UVLO) Operation

The UVLO circuit ensures that the device stays disabled before the input supply reaches the minimum operational voltage range, and ensures that the device shuts down when the input supply collapses. [Figure 8-2](#) shows the UVLO circuit response to various input voltage events. The diagram can be separated into the following parts:

- Region A: The device does not start until the input reaches the UVLO rising threshold.
- Region B: Normal operation, regulating device.
- Region C: Brownout event above the UVLO falling threshold (UVLO rising threshold – UVLO hysteresis). The output may fall out of regulation but the device remains enabled.
- Region D: Normal operation, regulating device.
- Region E: Brownout event below the UVLO falling threshold. The device is disabled in most cases and the output falls because of the load and active discharge circuit. The device is reenabled when the UVLO rising threshold is reached by the input voltage and a normal start-up follows.
- Region F: Normal operation followed by the input falling to the UVLO falling threshold.
- Region G: The device is disabled when the input voltage falls below the UVLO falling threshold to 0 V. The output falls because of the load and active discharge circuit.

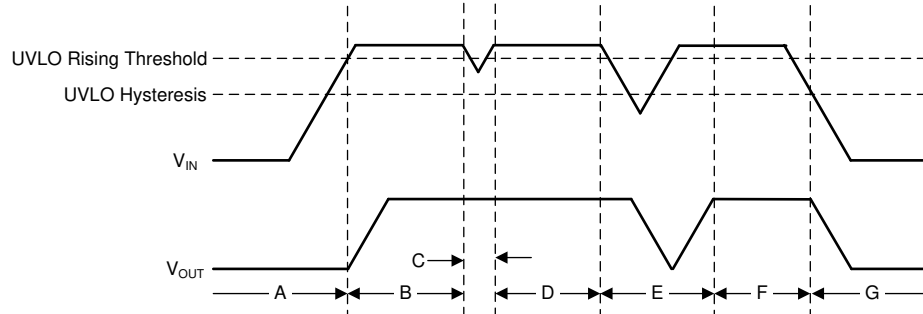

Figure 8-2. Typical UVLO Operation

8.1.5 Power Dissipation (P_D)

Circuit reliability demands that proper consideration be given to device power dissipation, location of the circuit on the printed circuit board (PCB), and correct sizing of the thermal plane. The PCB area around the regulator must be as free as possible of other heat-generating devices that cause added thermal stresses.

As a first-order approximation, power dissipation in the regulator depends on the input-to-output voltage difference and load conditions. Use [Equation 2](#) to approximate P_D :

$$P_D = (V_{IN} - V_{OUT}) \times I_{OUT} \quad (2)$$

Power dissipation can be minimized, and thus greater efficiency achieved, by proper selection of the system voltage rails. Proper selection allows the minimum input-to-output voltage differential to be obtained. The low dropout of the TPS7A02 allows for maximum efficiency across a wide range of output voltages.

The main heat conduction path for the device is through the thermal pad on the package. As such, the thermal pad must be soldered to a copper pad area under the device. This pad area contains an array of plated vias that conduct heat to any inner plane areas or to a bottom-side copper plane.

The maximum power dissipation determines the maximum allowable junction temperature (T_J) for the device. According to [Equation 3](#), power dissipation and junction temperature are most often related by the junction-to-ambient thermal resistance ($R_{\theta JA}$) of the combined PCB and device package and the temperature of the ambient air (T_A). [Equation 4](#) rearranges [Equation 3](#) for output current.

$$T_J = T_A + (R_{\theta JA} \times P_D) \quad (3)$$

$$I_{OUT} = (T_J - T_A) / [R_{\theta JA} \times (V_{IN} - V_{OUT})] \quad (4)$$

Unfortunately, this thermal resistance ($R_{\theta JA}$) is highly dependent on the heat-spreading capability built into the particular PCB design, and therefore varies according to the total copper area, copper weight, and location of the planes. The $R_{\theta JA}$ recorded in the [Thermal Information](#) table is determined by the JEDEC standard, PCB, and copper-spreading area, and is only used as a relative measure of package thermal performance. For a well-designed thermal layout, $R_{\theta JA}$ is actually the sum of the X2SON package junction-to-case (bottom) thermal resistance ($R_{\theta JC(bot)}$) plus the thermal resistance contribution by the PCB copper.

8.1.5.1 Estimating Junction Temperature

The JEDEC standard now recommends the use of psi (Ψ) thermal metrics to estimate the junction temperatures of the LDO when in-circuit on a typical PCB board application. These metrics are not strictly speaking thermal resistances, but rather offer practical and relative means of estimating junction temperatures. These psi metrics are determined to be significantly independent of the copper-spreading area. The key thermal metrics (Ψ_{JT} and Ψ_{JB}) are used in accordance with [Equation 5](#) and are given in the [Thermal Information](#) table.

$$\Psi_{JT} : T_J = T_T + \Psi_{JT} \times P_D \text{ and } \Psi_{JB} : T_J = T_B + \Psi_{JB} \times P_D \quad (5)$$

where:

- P_D is the power dissipated as explained in [Equation 2](#)
- T_T is the temperature at the center-top of the device package, and
- T_B is the PCB surface temperature measured 1 mm from the device package and centered on the package edge

8.1.5.2 Recommended Area for Continuous Operation

The operational area of an LDO is limited by the dropout voltage, output current, junction temperature, and input voltage. The recommended area for continuous operation for a linear regulator is given in [Figure 8-3](#) and can be separated into the following parts:

- Dropout voltage limits the minimum differential voltage between the input and the output ($V_{IN} - V_{OUT}$) at a given output current level. See the [Dropout Operation](#) section for more details.
- The rated output currents limits the maximum recommended output current level. Exceeding this rating causes the device to fall out of specification.
- The rated junction temperature limits the maximum junction temperature of the device. Exceeding this rating causes the device to fall out of specification and reduces long-term reliability.
 - The shape of the slope is given by [Equation 4](#). The slope is nonlinear because the maximum rated junction temperature of the LDO is controlled by the power dissipation across the LDO; thus when $V_{IN} - V_{OUT}$ increases the output current must decrease.
- The rated input voltage range governs both the minimum and maximum of $V_{IN} - V_{OUT}$.

Figure 8-3 shows the recommended area of operation for this device on a JEDEC-standard high-K board with a $R_{\theta JA}$ as given in the *Thermal Information* table.

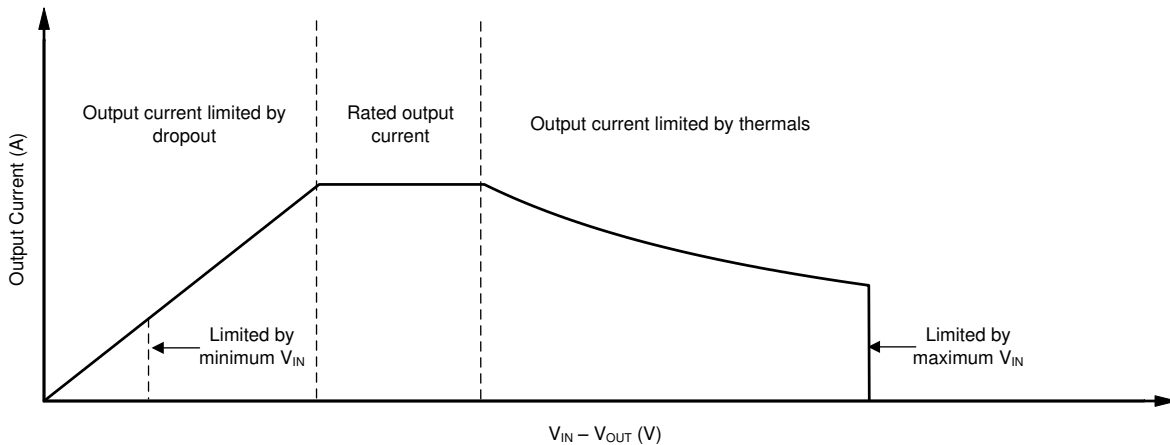

Figure 8-3. Region Description of Continuous Operation Regime

8.2 Typical Application

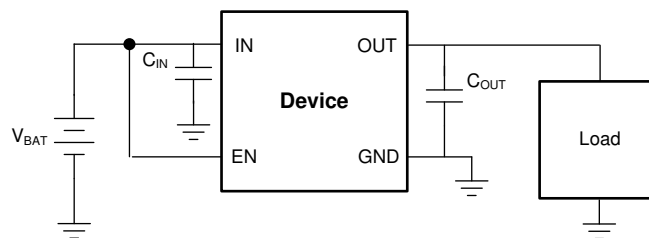

Figure 8-4. Operation From a Battery Input Supply

8.2.1 Design Requirements

Table 8-1. Design Parameters

PARAMETER	DESIGN REQUIREMENT
Input voltage	1.8 V to 3.0 V (two 1.5-V batteries)
Output voltage	1.0 V, $\pm 1\%$
Input current	200 mA, maximum
Output load	10-mA DC
Maximum ambient temperature	70°C

8.2.2 Detailed Design Procedure

For this design example, the 1.0-V, fixed-version TPS7A0210 is selected. A dual AA Alkaline battery was used, thus a 1.0- μF input capacitor is recommended to minimize transient currents drawn from the battery. A 1.0- μF output capacitor is also recommended for excellent load transient response. The dropout voltage (V_{DO}) is kept within the TPS7A02 dropout voltage specification for the 1.0-V output voltage option to keep the device in regulation under all load and temperature conditions for this design. Use the recommend 1- μF input and output capacitor because the input source has a high equivalent series resistor (ESR) of 600 m Ω (typ). The very small ground current consumed by the regulator maintains a high current efficiency as compared to the load current consumed by the system, as shown in Figure 8-5 which allows for long battery life. Equation 6 can be used to calculate the current efficiency (I_{η}) of this system.

$$I_{\eta}(\%) = I_{OUT} / (I_{OUT} + I_Q) \times 100 \quad (6)$$

8.2.3 Application Curve

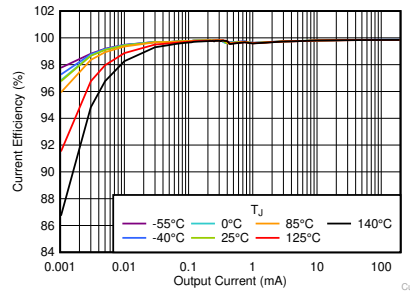

Figure 8-5. Current Efficiency vs I_{OUT} and Temperature

8.3 Power Supply Recommendations

This device is designed to operate from an input supply voltage range of 1.5 V to 6.0 V. The input supply must be well regulated and free of spurious noise. To ensure that the output voltage is well regulated and dynamic performance is optimum, the input supply must be at least $V_{OUT(nom)} + 0.5$ V. TI highly recommends using a 1- μ F or greater input capacitor to reduce the impedance of the input supply, especially during transients.

8.4 Layout

8.4.1 Layout Guidelines

- Place input and output capacitors as close to the device as possible.
- Use copper planes for device connections to optimize thermal performance.
- Place thermal vias around the device to distribute the heat.
- Do not place a thermal via directly beneath the thermal pad of the DQN package. A via can wick solder or solder paste away from the thermal pad joint during the soldering process, leading to a compromised solder joint on the thermal pad.

8.4.2 Layout Examples

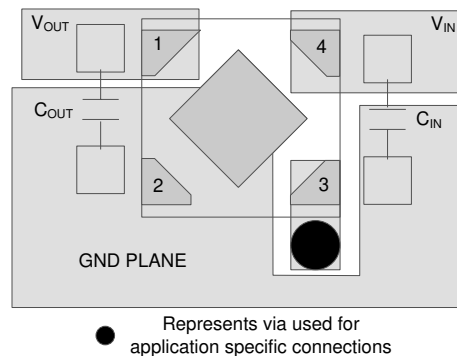
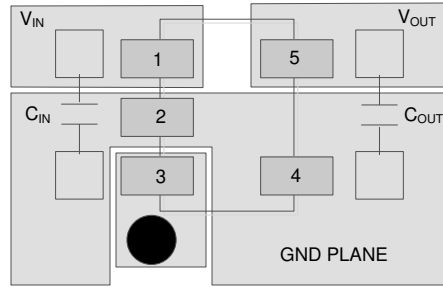

Figure 8-6. Layout Example for the DQN Package



● Represents via used for application specific connections

Figure 8-7. Layout Example for the DBV Package

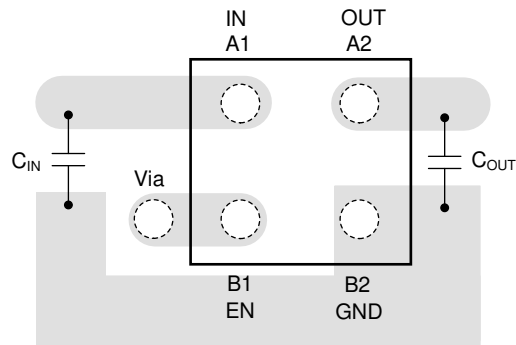

Figure 8-8. Layout Example for the YCH Package

9 Device and Documentation Support

9.1 Device Support

9.1.1 Device Nomenclature

Table 9-1. Device Nomenclature^{(1) (2)}

PRODUCT	V _{OUT}
TPS7A02 xx(x)Pyyyz	<p>XX(X) is the nominal output voltage. For output voltages with a resolution of 100 mV, two digits are used in the ordering number; otherwise, three digits are used (for example, 28 = 2.8 V; 125 = 1.25 V).</p> <p>P indicates an active output discharge feature. All members of the TPS7A02 family actively discharge the output when the device is disabled.</p> <p>YYY is the package designator.</p> <p>Z is the package quantity. R is for reel (3000 pieces), T is for tape (250 pieces).</p>

- (1) For the most current package and ordering information see the Package Option Addendum at the end of this document, or visit the device product folder on www.ti.com.
- (2) Output voltages from 1.0 V to 3.3 V in 50-mV increments are available. Contact the factory for details and availability.

9.2 Receiving Notification of Documentation Updates

To receive notification of documentation updates, navigate to the device product folder on ti.com. Click on *Subscribe to updates* to register and receive a weekly digest of any product information that has changed. For change details, review the revision history included in any revised document.

9.3 Support Resources

[TI E2E™ support forums](#) are an engineer's go-to source for fast, verified answers and design help — straight from the experts. Search existing answers or ask your own question to get the quick design help you need.

Linked content is provided "AS IS" by the respective contributors. They do not constitute TI specifications and do not necessarily reflect TI's views; see TI's [Terms of Use](#).

9.4 Trademarks

TI E2E™ is a trademark of Texas Instruments.
All trademarks are the property of their respective owners.

9.5 Electrostatic Discharge Caution



This integrated circuit can be damaged by ESD. Texas Instruments recommends that all integrated circuits be handled with appropriate precautions. Failure to observe proper handling and installation procedures can cause damage.

ESD damage can range from subtle performance degradation to complete device failure. Precision integrated circuits may be more susceptible to damage because very small parametric changes could cause the device not to meet its published specifications.

9.6 Glossary

[TI Glossary](#) This glossary lists and explains terms, acronyms, and definitions.

10 Mechanical, Packaging, and Orderable Information

The following pages include mechanical, packaging, and orderable information. This information is the most current data available for the designated devices. This data is subject to change without notice and revision of this document. For browser-based versions of this data sheet, refer to the left-hand navigation.

PACKAGING INFORMATION

Orderable part number	Status (1)	Material type (2)	Package Pins	Package qty Carrier	RoHS (3)	Lead finish/ Ball material (4)	MSL rating/ Peak reflow (5)	Op temp (°C)	Part marking (6)
TPS7A0210PDQNR	Active	Production	X2SON (DQN) 4	3000 LARGE T&R	Yes	NIPDAU NIPDAUAG	Level-1-260C-UNLIM	-40 to 125	GH
TPS7A0210PDQNR.A	Active	Production	X2SON (DQN) 4	3000 LARGE T&R	Yes	NIPDAU	Level-1-260C-UNLIM	-40 to 125	GH
TPS7A0212PDBVR	Active	Production	SOT-23 (DBV) 5	3000 LARGE T&R	Yes	NIPDAU SN	Level-1-260C-UNLIM	-40 to 125	21GF
TPS7A0212PDBVR.A	Active	Production	SOT-23 (DBV) 5	3000 LARGE T&R	Yes	SN	Level-1-260C-UNLIM	-40 to 125	21GF
TPS7A0212PYCHR	Active	Production	DSBGA (YCH) 4	12000 LARGE T&R	Yes	SNAGCU	Level-1-260C-UNLIM	-40 to 125	A
TPS7A0212PYCHR.A	Active	Production	DSBGA (YCH) 4	12000 LARGE T&R	Yes	SNAGCU	Level-1-260C-UNLIM	-40 to 125	A
TPS7A0215DQNR	Active	Production	X2SON (DQN) 4	3000 LARGE T&R	Yes	NIPDAU	Level-1-260C-UNLIM	-40 to 125	OS
TPS7A0215DQNR.A	Active	Production	X2SON (DQN) 4	3000 LARGE T&R	Yes	NIPDAU	Level-1-260C-UNLIM	-40 to 125	OS
TPS7A0215PDBVR	Active	Production	SOT-23 (DBV) 5	3000 LARGE T&R	Yes	NIPDAU SN	Level-1-260C-UNLIM	-40 to 125	21KF
TPS7A0215PDBVR.A	Active	Production	SOT-23 (DBV) 5	3000 LARGE T&R	Yes	SN	Level-1-260C-UNLIM	-40 to 125	21KF
TPS7A0215PDQNR	Active	Production	X2SON (DQN) 4	3000 LARGE T&R	Yes	NIPDAU NIPDAUAG	Level-1-260C-UNLIM	-40 to 125	F3
TPS7A0215PDQNR.A	Active	Production	X2SON (DQN) 4	3000 LARGE T&R	Yes	NIPDAU	Level-1-260C-UNLIM	-40 to 125	F3
TPS7A02175PYCHR	Active	Production	DSBGA (YCH) 4	12000 LARGE T&R	Yes	SNAGCU	Level-1-260C-UNLIM	-40 to 125	S
TPS7A02175PYCHR.A	Active	Production	DSBGA (YCH) 4	12000 LARGE T&R	Yes	SNAGCU	Level-1-260C-UNLIM	-40 to 125	S
TPS7A02185DQNR	Active	Production	X2SON (DQN) 4	3000 LARGE T&R	Yes	NIPDAU	Level-1-260C-UNLIM	-40 to 125	OR
TPS7A02185DQNR.A	Active	Production	X2SON (DQN) 4	3000 LARGE T&R	Yes	NIPDAU	Level-1-260C-UNLIM	-40 to 125	OR
TPS7A02185PDQNR	Active	Production	X2SON (DQN) 4	3000 LARGE T&R	Yes	NIPDAU NIPDAUAG	Level-1-260C-UNLIM	-40 to 125	HO
TPS7A02185PDQNR.A	Active	Production	X2SON (DQN) 4	3000 LARGE T&R	Yes	NIPDAU	Level-1-260C-UNLIM	-40 to 125	HO
TPS7A0218DBVR	Active	Production	SOT-23 (DBV) 5	3000 LARGE T&R	Yes	SN	Level-1-260C-UNLIM	-40 to 125	2CDT
TPS7A0218DBVR.A	Active	Production	SOT-23 (DBV) 5	3000 LARGE T&R	Yes	SN	Level-1-260C-UNLIM	-40 to 125	2CDT
TPS7A0218PDBVR	Active	Production	SOT-23 (DBV) 5	3000 LARGE T&R	Yes	NIPDAU SN	Level-1-260C-UNLIM	-40 to 125	21LF
TPS7A0218PDBVR.A	Active	Production	SOT-23 (DBV) 5	3000 LARGE T&R	Yes	NIPDAU	Level-1-260C-UNLIM	-40 to 125	21LF
TPS7A0218PDBVRG4	Active	Production	SOT-23 (DBV) 5	3000 LARGE T&R	Yes	NIPDAU	Level-1-260C-UNLIM	-40 to 125	21LF
TPS7A0218PDBVRG4.A	Active	Production	SOT-23 (DBV) 5	3000 LARGE T&R	Yes	NIPDAU	Level-1-260C-UNLIM	-40 to 125	21LF
TPS7A0218PDQNR	Active	Production	X2SON (DQN) 4	3000 LARGE T&R	Yes	NIPDAU NIPDAUAG	Level-1-260C-UNLIM	-40 to 125	F4
TPS7A0218PDQNR.A	Active	Production	X2SON (DQN) 4	3000 LARGE T&R	Yes	NIPDAU	Level-1-260C-UNLIM	-40 to 125	F4
TPS7A0218PYCHR	Active	Production	DSBGA (YCH) 4	12000 LARGE T&R	Yes	SNAGCU	Level-1-260C-UNLIM	-40 to 125	B
TPS7A0218PYCHR.A	Active	Production	DSBGA (YCH) 4	12000 LARGE T&R	Yes	SNAGCU	Level-1-260C-UNLIM	-40 to 125	B
TPS7A0220PDBVR	Active	Production	SOT-23 (DBV) 5	3000 LARGE T&R	Yes	NIPDAU SN	Level-1-260C-UNLIM	-40 to 125	22MT

Orderable part number	Status (1)	Material type (2)	Package Pins	Package qty Carrier	RoHS (3)	Lead finish/ Ball material (4)	MSL rating/ Peak reflow (5)	Op temp (°C)	Part marking (6)
TPS7A0220PDBVR.A	Active	Production	SOT-23 (DBV) 5	3000 LARGE T&R	Yes	SN	Level-1-260C-UNLIM	-40 to 125	22MT
TPS7A0220PDQNR	Active	Production	X2SON (DQN) 4	3000 LARGE T&R	Yes	NIPDAU NIPDAUAG	Level-1-260C-UNLIM	-40 to 125	F5
TPS7A0220PDQNR.A	Active	Production	X2SON (DQN) 4	3000 LARGE T&R	Yes	NIPDAU	Level-1-260C-UNLIM	-40 to 125	F5
TPS7A0222DQNR	Active	Production	X2SON (DQN) 4	3000 LARGE T&R	Yes	NIPDAU	Level-1-260C-UNLIM	-40 to 125	IN
TPS7A0222DQNR.A	Active	Production	X2SON (DQN) 4	3000 LARGE T&R	Yes	NIPDAU	Level-1-260C-UNLIM	-40 to 125	IN
TPS7A0222PDBVR	Active	Production	SOT-23 (DBV) 5	3000 LARGE T&R	Yes	NIPDAU SN	Level-1-260C-UNLIM	-40 to 125	21HF
TPS7A0222PDBVR.A	Active	Production	SOT-23 (DBV) 5	3000 LARGE T&R	Yes	SN	Level-1-260C-UNLIM	-40 to 125	21HF
TPS7A0222PDQNR	Active	Production	X2SON (DQN) 4	3000 LARGE T&R	Yes	NIPDAU NIPDAUAG	Level-1-260C-UNLIM	-40 to 125	GI
TPS7A0222PDQNR.A	Active	Production	X2SON (DQN) 4	3000 LARGE T&R	Yes	NIPDAU	Level-1-260C-UNLIM	-40 to 125	GI
TPS7A0223PDBVR	Active	Production	SOT-23 (DBV) 5	3000 LARGE T&R	Yes	NIPDAU SN	Level-1-260C-UNLIM	-40 to 125	21IF
TPS7A0223PDBVR.A	Active	Production	SOT-23 (DBV) 5	3000 LARGE T&R	Yes	NIPDAU	Level-1-260C-UNLIM	-40 to 125	21IF
TPS7A0223PDQNR	Active	Production	X2SON (DQN) 4	3000 LARGE T&R	Yes	NIPDAU NIPDAUAG	Level-1-260C-UNLIM	-40 to 125	F6
TPS7A0223PDQNR.A	Active	Production	X2SON (DQN) 4	3000 LARGE T&R	Yes	NIPDAU	Level-1-260C-UNLIM	-40 to 125	F6
TPS7A0225PDBVR	Active	Production	SOT-23 (DBV) 5	3000 LARGE T&R	Yes	NIPDAU SN	Level-1-260C-UNLIM	-40 to 125	21DF
TPS7A0225PDBVR.A	Active	Production	SOT-23 (DBV) 5	3000 LARGE T&R	Yes	NIPDAU	Level-1-260C-UNLIM	-40 to 125	21DF
TPS7A0225PDQNR	Active	Production	X2SON (DQN) 4	3000 LARGE T&R	Yes	NIPDAU NIPDAUAG	Level-1-260C-UNLIM	-40 to 125	F7
TPS7A0225PDQNR.A	Active	Production	X2SON (DQN) 4	3000 LARGE T&R	Yes	NIPDAU	Level-1-260C-UNLIM	-40 to 125	F7
TPS7A0225PYCHR	Active	Production	DSBGA (YCH) 4	12000 LARGE T&R	Yes	SNAGCU	Level-1-260C-UNLIM	-40 to 125	C
TPS7A0225PYCHR.A	Active	Production	DSBGA (YCH) 4	12000 LARGE T&R	Yes	SNAGCU	Level-1-260C-UNLIM	-40 to 125	C
TPS7A0228DBVR	Active	Production	SOT-23 (DBV) 5	3000 LARGE T&R	Yes	Call TI Sn Nipdau	Level-1-260C-UNLIM	-40 to 125	29PT
TPS7A0228DBVR.A	Active	Production	SOT-23 (DBV) 5	3000 LARGE T&R	Yes	NIPDAU	Level-1-260C-UNLIM	-40 to 125	29PT
TPS7A0228DQNR	Active	Production	X2SON (DQN) 4	3000 LARGE T&R	Yes	NIPDAU	Level-1-260C-UNLIM	-40 to 125	IE
TPS7A0228DQNR.A	Active	Production	X2SON (DQN) 4	3000 LARGE T&R	Yes	NIPDAU	Level-1-260C-UNLIM	-40 to 125	IE
TPS7A0228PDBVR	Active	Production	SOT-23 (DBV) 5	3000 LARGE T&R	Yes	NIPDAU SN	Level-1-260C-UNLIM	-40 to 125	21EF
TPS7A0228PDBVR.A	Active	Production	SOT-23 (DBV) 5	3000 LARGE T&R	Yes	NIPDAU	Level-1-260C-UNLIM	-40 to 125	21EF
TPS7A0228PDQNR	Active	Production	X2SON (DQN) 4	3000 LARGE T&R	Yes	NIPDAU NIPDAUAG	Level-1-260C-UNLIM	-40 to 125	F8
TPS7A0228PDQNR.A	Active	Production	X2SON (DQN) 4	3000 LARGE T&R	Yes	NIPDAU	Level-1-260C-UNLIM	-40 to 125	F8
TPS7A0228PYCHR	Active	Production	DSBGA (YCH) 4	12000 LARGE T&R	Yes	SNAGCU	Level-1-260C-UNLIM	-40 to 125	D
TPS7A0228PYCHR.A	Active	Production	DSBGA (YCH) 4	12000 LARGE T&R	Yes	SNAGCU	Level-1-260C-UNLIM	-40 to 125	D
TPS7A0230PDBVR	Active	Production	SOT-23 (DBV) 5	3000 LARGE T&R	Yes	NIPDAU SN	Level-1-260C-UNLIM	-40 to 125	21MF
TPS7A0230PDBVR.A	Active	Production	SOT-23 (DBV) 5	3000 LARGE T&R	Yes	SN	Level-1-260C-UNLIM	-40 to 125	21MF

Orderable part number	Status (1)	Material type (2)	Package Pins	Package qty Carrier	RoHS (3)	Lead finish/ Ball material (4)	MSL rating/ Peak reflow (5)	Op temp (°C)	Part marking (6)
TPS7A0230PDBVRG4	Active	Production	SOT-23 (DBV) 5	3000 LARGE T&R	Yes	NIPDAU	Level-1-260C-UNLIM	-40 to 125	21MF
TPS7A0230PDBVRG4.A	Active	Production	SOT-23 (DBV) 5	3000 LARGE T&R	Yes	NIPDAU	Level-1-260C-UNLIM	-40 to 125	21MF
TPS7A0230PDQNR	Active	Production	X2SON (DQN) 4	3000 LARGE T&R	Yes	NIPDAU NIPDAUAG	Level-1-260C-UNLIM	-40 to 125	F9
TPS7A0230PDQNR.A	Active	Production	X2SON (DQN) 4	3000 LARGE T&R	Yes	NIPDAU	Level-1-260C-UNLIM	-40 to 125	F9
TPS7A0230PYCHR	Active	Production	DSBGA (YCH) 4	12000 LARGE T&R	Yes	SNAGCU	Level-1-260C-UNLIM	-40 to 125	F
TPS7A0230PYCHR.A	Active	Production	DSBGA (YCH) 4	12000 LARGE T&R	Yes	SNAGCU	Level-1-260C-UNLIM	-40 to 125	F
TPS7A0231PDQNR	Active	Production	X2SON (DQN) 4	3000 LARGE T&R	Yes	NIPDAU NIPDAUAG	Level-1-260C-UNLIM	-40 to 125	GJ
TPS7A0231PDQNR.A	Active	Production	X2SON (DQN) 4	3000 LARGE T&R	Yes	NIPDAU	Level-1-260C-UNLIM	-40 to 125	GJ
TPS7A0233DBVR	Active	Production	SOT-23 (DBV) 5	3000 LARGE T&R	Yes	SN	Level-1-260C-UNLIM	-40 to 125	29QT
TPS7A0233DBVR.A	Active	Production	SOT-23 (DBV) 5	3000 LARGE T&R	Yes	SN	Level-1-260C-UNLIM	-40 to 125	29QT
TPS7A0233DQNR	Active	Production	X2SON (DQN) 4	3000 LARGE T&R	Yes	NIPDAU	Level-1-260C-UNLIM	-40 to 125	IF
TPS7A0233DQNR.A	Active	Production	X2SON (DQN) 4	3000 LARGE T&R	Yes	NIPDAU	Level-1-260C-UNLIM	-40 to 125	IF
TPS7A0233PDBVR	Active	Production	SOT-23 (DBV) 5	3000 LARGE T&R	Yes	NIPDAU SN	Level-1-260C-UNLIM	-40 to 125	21FF
TPS7A0233PDBVR.A	Active	Production	SOT-23 (DBV) 5	3000 LARGE T&R	Yes	SN	Level-1-260C-UNLIM	-40 to 125	21FF
TPS7A0233PDQNR	Active	Production	X2SON (DQN) 4	3000 LARGE T&R	Yes	NIPDAU NIPDAUAG	Level-1-260C-UNLIM	-40 to 125	FA
TPS7A0233PDQNR.A	Active	Production	X2SON (DQN) 4	3000 LARGE T&R	Yes	NIPDAU	Level-1-260C-UNLIM	-40 to 125	FA
TPS7A0233PYCHR	Active	Production	DSBGA (YCH) 4	12000 LARGE T&R	Yes	SNAGCU	Level-1-260C-UNLIM	-40 to 125	G
TPS7A0233PYCHR.A	Active	Production	DSBGA (YCH) 4	12000 LARGE T&R	Yes	SNAGCU	Level-1-260C-UNLIM	-40 to 125	G
TPS7A0236PDBVR	Active	Production	SOT-23 (DBV) 5	3000 LARGE T&R	Yes	NIPDAU SN	Level-1-260C-UNLIM	-40 to 125	(21FF, 21JF)
TPS7A0236PDBVR.A	Active	Production	SOT-23 (DBV) 5	3000 LARGE T&R	Yes	NIPDAU	Level-1-260C-UNLIM	-40 to 125	(21FF, 21JF)

(1) **Status:** For more details on status, see our [product life cycle](#).

(2) **Material type:** When designated, preproduction parts are prototypes/experimental devices, and are not yet approved or released for full production. Testing and final process, including without limitation quality assurance, reliability performance testing, and/or process qualification, may not yet be complete, and this item is subject to further changes or possible discontinuation. If available for ordering, purchases will be subject to an additional waiver at checkout, and are intended for early internal evaluation purposes only. These items are sold without warranties of any kind.

(3) **RoHS values:** Yes, No, RoHS Exempt. See the [TI RoHS Statement](#) for additional information and value definition.

(4) **Lead finish/Ball material:** Parts may have multiple material finish options. Finish options are separated by a vertical ruled line. Lead finish/Ball material values may wrap to two lines if the finish value exceeds the maximum column width.

(5) **MSL rating/Peak reflow:** The moisture sensitivity level ratings and peak solder (reflow) temperatures. In the event that a part has multiple moisture sensitivity ratings, only the lowest level per JEDEC standards is shown. Refer to the shipping label for the actual reflow temperature that will be used to mount the part to the printed circuit board.

(6) **Part marking:** There may be an additional marking, which relates to the logo, the lot trace code information, or the environmental category of the part.

Multiple part markings will be inside parentheses. Only one part marking contained in parentheses and separated by a "~" will appear on a part. If a line is indented then it is a continuation of the previous line and the two combined represent the entire part marking for that device.

Important Information and Disclaimer:The information provided on this page represents TI's knowledge and belief as of the date that it is provided. TI bases its knowledge and belief on information provided by third parties, and makes no representation or warranty as to the accuracy of such information. Efforts are underway to better integrate information from third parties. TI has taken and continues to take reasonable steps to provide representative and accurate information but may not have conducted destructive testing or chemical analysis on incoming materials and chemicals. TI and TI suppliers consider certain information to be proprietary, and thus CAS numbers and other limited information may not be available for release.

In no event shall TI's liability arising out of such information exceed the total purchase price of the TI part(s) at issue in this document sold by TI to Customer on an annual basis.

TAPE AND REEL INFORMATION

QUADRANT ASSIGNMENTS FOR PIN 1 ORIENTATION IN TAPE

*All dimensions are nominal

Device	Package Type	Package Drawing	Pins	SPQ	Reel Diameter (mm)	Reel Width W1 (mm)	A0 (mm)	B0 (mm)	K0 (mm)	P1 (mm)	W (mm)	Pin1 Quadrant
TPS7A0210PDQNR	X2SON	DQN	4	3000	180.0	8.4	1.16	1.16	0.5	4.0	8.0	Q2
TPS7A0212PDBVR	SOT-23	DBV	5	3000	180.0	8.4	3.2	3.2	1.4	4.0	8.0	Q3
TPS7A0212PYCHR	DSBGA	YCH	4	12000	180.0	8.4	0.72	0.72	0.42	2.0	8.0	Q1
TPS7A0215DQNR	X2SON	DQN	4	3000	180.0	8.4	1.16	1.16	0.5	4.0	8.0	Q2
TPS7A0215PDBVR	SOT-23	DBV	5	3000	178.0	8.4	3.2	3.2	1.4	4.0	8.0	Q3
TPS7A0215PDQNR	X2SON	DQN	4	3000	180.0	8.4	1.16	1.16	0.5	4.0	8.0	Q2
TPS7A02175PYCHR	DSBGA	YCH	4	12000	180.0	8.4	0.72	0.72	0.42	2.0	8.0	Q1
TPS7A02185DQNR	X2SON	DQN	4	3000	180.0	8.4	1.16	1.16	0.5	4.0	8.0	Q2
TPS7A02185PDQNR	X2SON	DQN	4	3000	180.0	8.4	1.16	1.16	0.5	4.0	8.0	Q2
TPS7A0218DBVR	SOT-23	DBV	5	3000	180.0	8.4	3.2	3.2	1.4	4.0	8.0	Q3
TPS7A0218PDBVR	SOT-23	DBV	5	3000	180.0	8.4	3.2	3.2	1.4	4.0	8.0	Q3
TPS7A0218PDBVR	SOT-23	DBV	5	3000	178.0	9.0	3.3	3.2	1.4	4.0	8.0	Q3
TPS7A0218PDBVRG4	SOT-23	DBV	5	3000	180.0	8.4	3.2	3.2	1.4	4.0	8.0	Q3
TPS7A0218PDQNR	X2SON	DQN	4	3000	180.0	8.4	1.16	1.16	0.5	4.0	8.0	Q2
TPS7A0218PYCHR	DSBGA	YCH	4	12000	180.0	8.4	0.72	0.72	0.42	2.0	8.0	Q1

Device	Package Type	Package Drawing	Pins	SPQ	Reel Diameter (mm)	Reel Width W1 (mm)	A0 (mm)	B0 (mm)	K0 (mm)	P1 (mm)	W (mm)	Pin1 Quadrant
TPS7A0220PDBVR	SOT-23	DBV	5	3000	180.0	8.4	3.2	3.2	1.4	4.0	8.0	Q3
TPS7A0220PDBVR	SOT-23	DBV	5	3000	180.0	8.4	3.2	3.2	1.4	4.0	8.0	Q3
TPS7A0220PDQNR	X2SON	DQN	4	3000	180.0	8.4	1.16	1.16	0.5	4.0	8.0	Q2
TPS7A0222DQNR	X2SON	DQN	4	3000	180.0	8.4	1.16	1.16	0.5	4.0	8.0	Q2
TPS7A0222PDBVR	SOT-23	DBV	5	3000	180.0	8.4	3.2	3.2	1.4	4.0	8.0	Q3
TPS7A0222PDQNR	X2SON	DQN	4	3000	180.0	8.4	1.16	1.16	0.5	4.0	8.0	Q2
TPS7A0223PDBVR	SOT-23	DBV	5	3000	180.0	8.4	3.2	3.2	1.4	4.0	8.0	Q3
TPS7A0223PDQNR	X2SON	DQN	4	3000	180.0	8.4	1.16	1.16	0.5	4.0	8.0	Q2
TPS7A0225PDBVR	SOT-23	DBV	5	3000	178.0	9.0	3.3	3.2	1.4	4.0	8.0	Q3
TPS7A0225PDBVR	SOT-23	DBV	5	3000	180.0	8.4	3.2	3.2	1.4	4.0	8.0	Q3
TPS7A0225PDQNR	X2SON	DQN	4	3000	180.0	8.4	1.16	1.16	0.5	4.0	8.0	Q2
TPS7A0225PYCHR	DSBGA	YCH	4	12000	180.0	8.4	0.72	0.72	0.42	2.0	8.0	Q1
TPS7A0228DBVR	SOT-23	DBV	5	3000	180.0	8.4	3.2	3.2	1.4	4.0	8.0	Q3
TPS7A0228DBVR	SOT-23	DBV	5	3000	180.0	8.4	3.2	3.2	1.4	4.0	8.0	Q3
TPS7A0228DQNR	X2SON	DQN	4	3000	180.0	8.4	1.16	1.16	0.5	4.0	8.0	Q2
TPS7A0228PDBVR	SOT-23	DBV	5	3000	178.0	8.4	3.2	3.2	1.4	4.0	8.0	Q3
TPS7A0228PDQNR	X2SON	DQN	4	3000	180.0	8.4	1.16	1.16	0.5	4.0	8.0	Q2
TPS7A0228PYCHR	DSBGA	YCH	4	12000	180.0	8.4	0.72	0.72	0.42	2.0	8.0	Q1
TPS7A0230PDBVR	SOT-23	DBV	5	3000	178.0	8.4	3.2	3.2	1.4	4.0	8.0	Q3
TPS7A0230PDBVRG4	SOT-23	DBV	5	3000	180.0	8.4	3.2	3.2	1.4	4.0	8.0	Q3
TPS7A0230PDQNR	X2SON	DQN	4	3000	180.0	8.4	1.16	1.16	0.5	4.0	8.0	Q2
TPS7A0230PYCHR	DSBGA	YCH	4	12000	180.0	8.4	0.72	0.72	0.42	2.0	8.0	Q1
TPS7A0231PDQNR	X2SON	DQN	4	3000	180.0	8.4	1.16	1.16	0.5	4.0	8.0	Q2
TPS7A0233DBVR	SOT-23	DBV	5	3000	180.0	8.4	3.2	3.2	1.4	4.0	8.0	Q3
TPS7A0233DQNR	X2SON	DQN	4	3000	180.0	8.4	1.16	1.16	0.5	4.0	8.0	Q2
TPS7A0233PDBVR	SOT-23	DBV	5	3000	178.0	9.0	3.3	3.2	1.4	4.0	8.0	Q3
TPS7A0233PDBVR	SOT-23	DBV	5	3000	180.0	8.4	3.2	3.2	1.4	4.0	8.0	Q3
TPS7A0233PDQNR	X2SON	DQN	4	3000	180.0	8.4	1.16	1.16	0.5	4.0	8.0	Q2
TPS7A0233PYCHR	DSBGA	YCH	4	12000	180.0	8.4	0.72	0.72	0.42	2.0	8.0	Q1
TPS7A0236PDBVR	SOT-23	DBV	5	3000	180.0	8.4	3.2	3.2	1.4	4.0	8.0	Q3

TAPE AND REEL BOX DIMENSIONS



*All dimensions are nominal

Device	Package Type	Package Drawing	Pins	SPQ	Length (mm)	Width (mm)	Height (mm)
TPS7A0210PDQNR	X2SON	DQN	4	3000	210.0	185.0	35.0
TPS7A0212PDBVR	SOT-23	DBV	5	3000	210.0	185.0	35.0
TPS7A0212PDBVR	SOT-23	DBV	5	3000	210.0	185.0	35.0
TPS7A0212PYCHR	DSBGA	YCH	4	12000	182.0	182.0	20.0
TPS7A0215DQNR	X2SON	DQN	4	3000	210.0	185.0	35.0
TPS7A0215PDBVR	SOT-23	DBV	5	3000	208.0	191.0	35.0
TPS7A0215PDQNR	X2SON	DQN	4	3000	210.0	185.0	35.0
TPS7A02175PYCHR	DSBGA	YCH	4	12000	182.0	182.0	20.0
TPS7A02185DQNR	X2SON	DQN	4	3000	210.0	185.0	35.0
TPS7A02185PDQNR	X2SON	DQN	4	3000	210.0	185.0	35.0
TPS7A0218DBVR	SOT-23	DBV	5	3000	210.0	185.0	35.0
TPS7A0218PDBVR	SOT-23	DBV	5	3000	210.0	185.0	35.0
TPS7A0218PDBVR	SOT-23	DBV	5	3000	180.0	180.0	18.0
TPS7A0218PDBVRG4	SOT-23	DBV	5	3000	210.0	185.0	35.0
TPS7A0218PDQNR	X2SON	DQN	4	3000	210.0	185.0	35.0
TPS7A0218PYCHR	DSBGA	YCH	4	12000	182.0	182.0	20.0
TPS7A0220PDBVR	SOT-23	DBV	5	3000	210.0	185.0	35.0
TPS7A0220PDBVR	SOT-23	DBV	5	3000	210.0	185.0	35.0

Device	Package Type	Package Drawing	Pins	SPQ	Length (mm)	Width (mm)	Height (mm)
TPS7A0220PDQNR	X2SON	DQN	4	3000	210.0	185.0	35.0
TPS7A0222DQNR	X2SON	DQN	4	3000	210.0	185.0	35.0
TPS7A0222PDBVR	SOT-23	DBV	5	3000	210.0	185.0	35.0
TPS7A0222PDQNR	X2SON	DQN	4	3000	210.0	185.0	35.0
TPS7A0223PDBVR	SOT-23	DBV	5	3000	210.0	185.0	35.0
TPS7A0223PDQNR	X2SON	DQN	4	3000	210.0	185.0	35.0
TPS7A0225PDBVR	SOT-23	DBV	5	3000	180.0	180.0	18.0
TPS7A0225PDBVR	SOT-23	DBV	5	3000	210.0	185.0	35.0
TPS7A0225PDQNR	X2SON	DQN	4	3000	210.0	185.0	35.0
TPS7A0225PYCHR	DSBGA	YCH	4	12000	182.0	182.0	20.0
TPS7A0228DBVR	SOT-23	DBV	5	3000	210.0	185.0	35.0
TPS7A0228DBVR	SOT-23	DBV	5	3000	210.0	185.0	35.0
TPS7A0228DQNR	X2SON	DQN	4	3000	210.0	185.0	35.0
TPS7A0228PDBVR	SOT-23	DBV	5	3000	208.0	191.0	35.0
TPS7A0228PDQNR	X2SON	DQN	4	3000	210.0	185.0	35.0
TPS7A0228PYCHR	DSBGA	YCH	4	12000	182.0	182.0	20.0
TPS7A0230PDBVR	SOT-23	DBV	5	3000	208.0	191.0	35.0
TPS7A0230PDBVRG4	SOT-23	DBV	5	3000	210.0	185.0	35.0
TPS7A0230PDQNR	X2SON	DQN	4	3000	210.0	185.0	35.0
TPS7A0230PYCHR	DSBGA	YCH	4	12000	182.0	182.0	20.0
TPS7A0231PDQNR	X2SON	DQN	4	3000	210.0	185.0	35.0
TPS7A0233DBVR	SOT-23	DBV	5	3000	210.0	185.0	35.0
TPS7A0233DQNR	X2SON	DQN	4	3000	210.0	185.0	35.0
TPS7A0233PDBVR	SOT-23	DBV	5	3000	180.0	180.0	18.0
TPS7A0233PDBVR	SOT-23	DBV	5	3000	210.0	185.0	35.0
TPS7A0233PDQNR	X2SON	DQN	4	3000	210.0	185.0	35.0
TPS7A0233PYCHR	DSBGA	YCH	4	12000	182.0	182.0	20.0
TPS7A0236PDBVR	SOT-23	DBV	5	3000	210.0	185.0	35.0

EXAMPLE BOARD LAYOUT

DBV0005A

SOT-23 - 1.45 mm max height

SMALL OUTLINE TRANSISTOR



LAND PATTERN EXAMPLE
EXPOSED METAL SHOWN
SCALE:15X

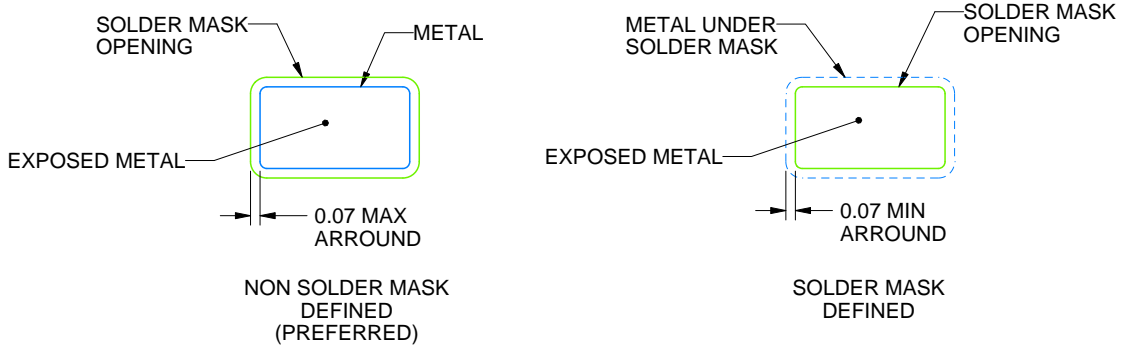

SOLDER MASK DETAILS

4214839/K 08/2024

NOTES: (continued)

- 6. Publication IPC-7351 may have alternate designs.
- 7. Solder mask tolerances between and around signal pads can vary based on board fabrication site.

EXAMPLE STENCIL DESIGN

DBV0005A

SOT-23 - 1.45 mm max height

SMALL OUTLINE TRANSISTOR

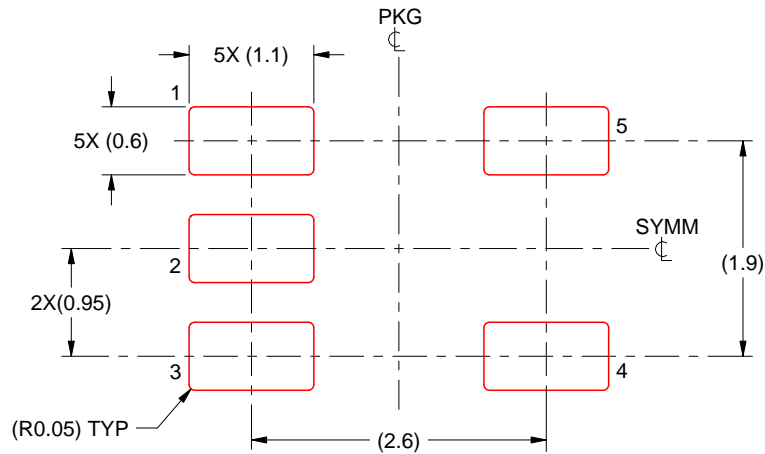

SOLDER PASTE EXAMPLE
BASED ON 0.125 mm THICK STENCIL
SCALE:15X

4214839/K 08/2024

NOTES: (continued)

8. Laser cutting apertures with trapezoidal walls and rounded corners may offer better paste release. IPC-7525 may have alternate design recommendations.
9. Board assembly site may have different recommendations for stencil design.

GENERIC PACKAGE VIEW

DQN 4

X2SON - 0.4 mm max height

PLASTIC SMALL OUTLINE - NO LEAD



Images above are just a representation of the package family, actual package may vary.
Refer to the product data sheet for package details.

4210367/F

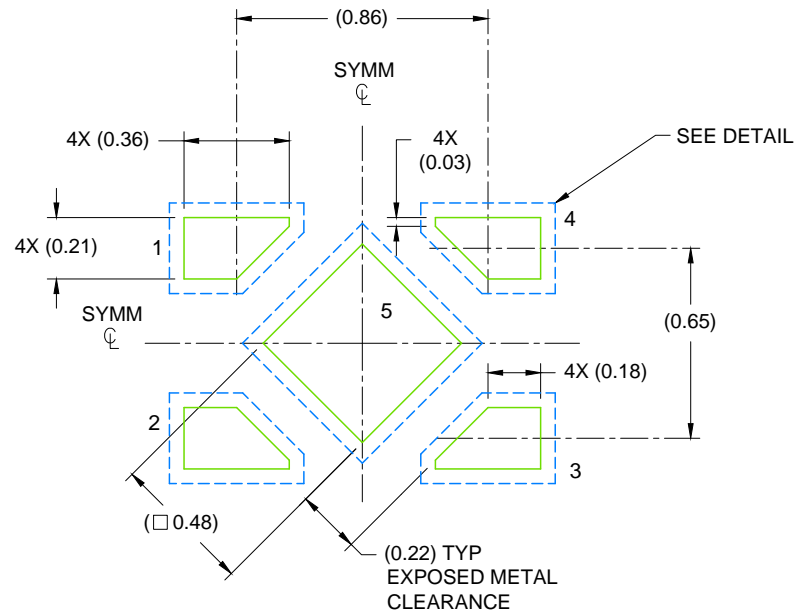

LAND PATTERN EXAMPLE
SCALE: 40X

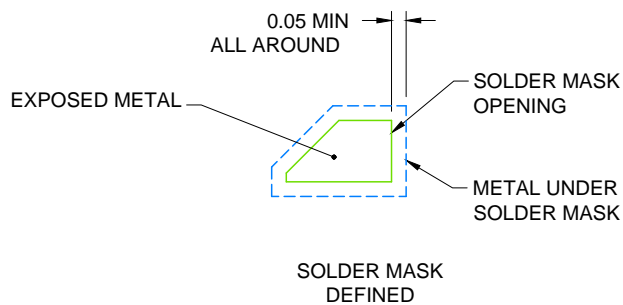

SOLDER MASK DETAIL

4215302/E 12/2016

NOTES: (continued)

7. This package is designed to be soldered to a thermal pad on the board. For more information, see Texas Instruments literature number SLUA271 (www.ti.com/lit/sluea271).
8. If any vias are implemented, it is recommended that vias under paste be filled, plugged or tented.

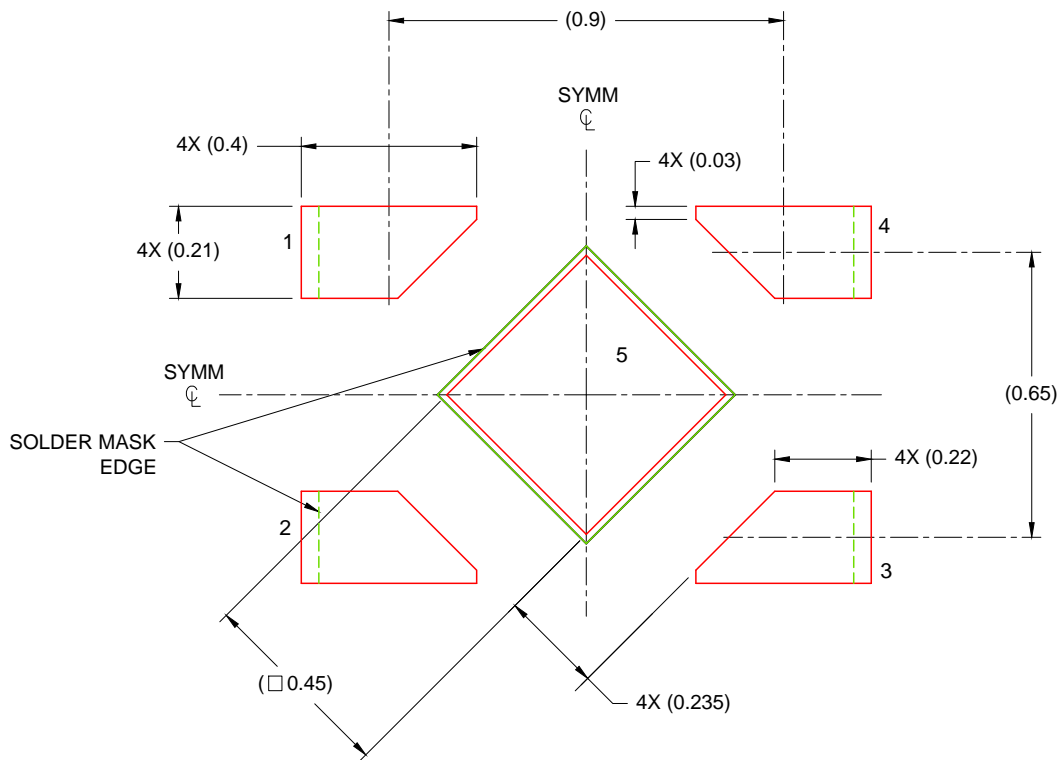

SOLDER PASTE EXAMPLE
 BASED ON 0.075 - 0.1mm THICK STENCIL
 EXPOSED PAD
 88% PRINTED SOLDER COVERAGE BY AREA
 SCALE: 60X

4215302/E 12/2016

NOTES: (continued)

- 9. Laser cutting apertures with trapezoidal walls and rounded corners may offer better paste release. IPC-7525 may have alternate design recommendations.

YCH0004



PACKAGE OUTLINE

DSBGA - 0.4 mm max height

DIE SIZE BALL GRID ARRAY

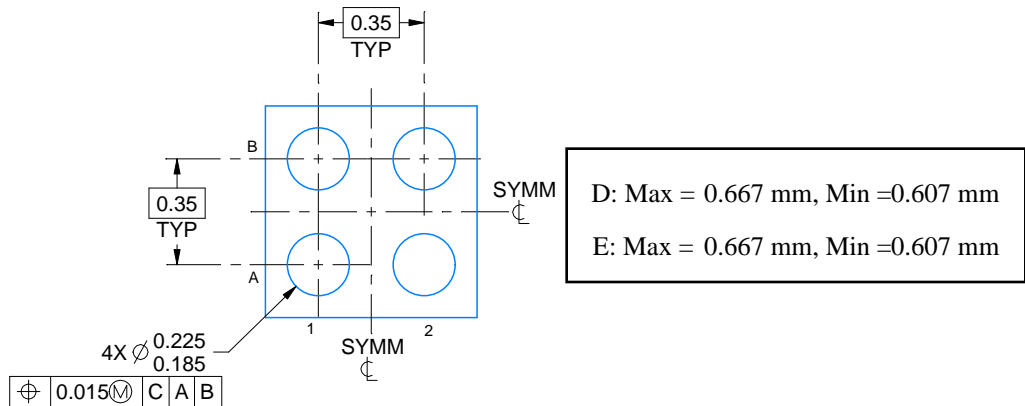
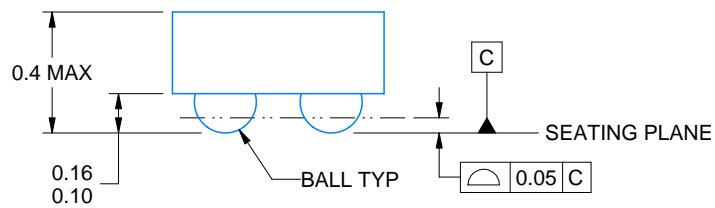
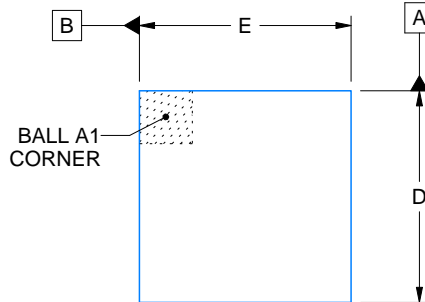

4224061/A 12/2017

NOTES:

1. All linear dimensions are in millimeters. Any dimensions in parenthesis are for reference only. Dimensioning and tolerancing per ASME Y14.5M.
2. This drawing is subject to change without notice.

EXAMPLE BOARD LAYOUT

YCH0004

DSBGA - 0.4 mm max height

DIE SIZE BALL GRID ARRAY

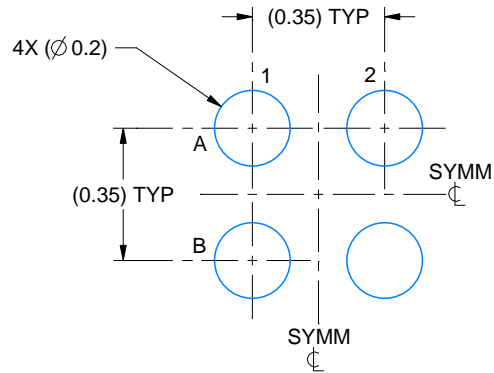

LAND PATTERN EXAMPLE
EXPOSED METAL SHOWN
SCALE: 50X

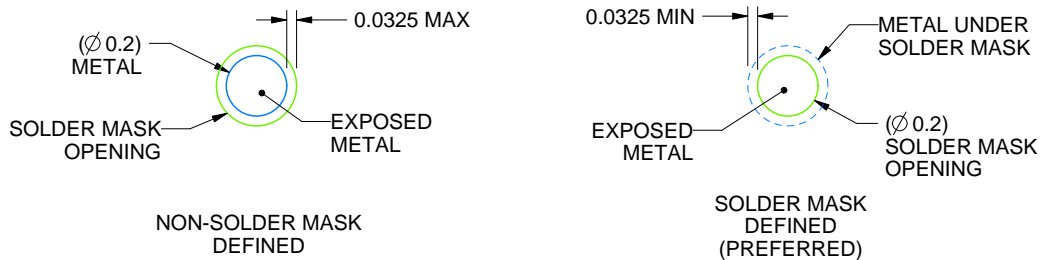

SOLDER MASK DETAILS
NOT TO SCALE

4224061/A 12/2017

NOTES: (continued)

- Final dimensions may vary due to manufacturing tolerance considerations and also routing constraints. See Texas Instruments Literature No. SNVA009 (www.ti.com/lit/snva009).

EXAMPLE STENCIL DESIGN

YCH0004

DSBGA - 0.4 mm max height

DIE SIZE BALL GRID ARRAY

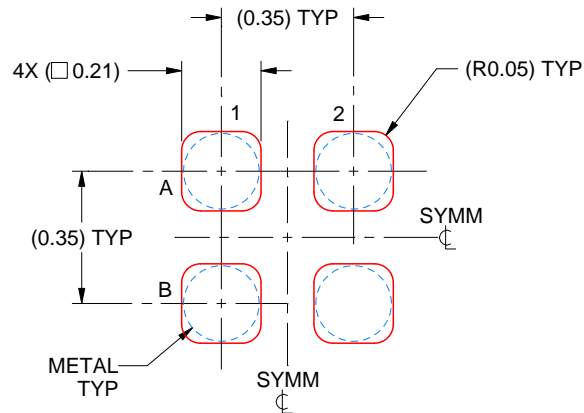

SOLDER PASTE EXAMPLE
BASED ON 0.075 mm THICK STENCIL
SCALE: 50X

4224061/A 12/2017

NOTES: (continued)

4. Laser cutting apertures with trapezoidal walls and rounded corners may offer better paste release.

IMPORTANT NOTICE AND DISCLAIMER

TI PROVIDES TECHNICAL AND RELIABILITY DATA (INCLUDING DATASHEETS), DESIGN RESOURCES (INCLUDING REFERENCE DESIGNS), APPLICATION OR OTHER DESIGN ADVICE, WEB TOOLS, SAFETY INFORMATION, AND OTHER RESOURCES "AS IS" AND WITH ALL FAULTS, AND DISCLAIMS ALL WARRANTIES, EXPRESS AND IMPLIED, INCLUDING WITHOUT LIMITATION ANY IMPLIED WARRANTIES OF MERCHANTABILITY, FITNESS FOR A PARTICULAR PURPOSE OR NON-INFRINGEMENT OF THIRD PARTY INTELLECTUAL PROPERTY RIGHTS.

These resources are intended for skilled developers designing with TI products. You are solely responsible for (1) selecting the appropriate TI products for your application, (2) designing, validating and testing your application, and (3) ensuring your application meets applicable standards, and any other safety, security, regulatory or other requirements.

These resources are subject to change without notice. TI grants you permission to use these resources only for development of an application that uses the TI products described in the resource. Other reproduction and display of these resources is prohibited. No license is granted to any other TI intellectual property right or to any third party intellectual property right. TI disclaims responsibility for, and you fully indemnify TI and its representatives against any claims, damages, costs, losses, and liabilities arising out of your use of these resources.

TI's products are provided subject to [TI's Terms of Sale](#), [TI's General Quality Guidelines](#), or other applicable terms available either on ti.com or provided in conjunction with such TI products. TI's provision of these resources does not expand or otherwise alter TI's applicable warranties or warranty disclaimers for TI products. Unless TI explicitly designates a product as custom or customer-specified, TI products are standard, catalog, general purpose devices.

TI objects to and rejects any additional or different terms you may propose.

Copyright © 2026, Texas Instruments Incorporated

Last updated 10/2025

Looking for pricing, stock, or lifecycle information?

Click below to explore more details on WIN SOURCE:

 [View TPS281C100ADNTR on WIN SOURCE](#)

 [Texas Instruments](#) Information

Optimize Your Supply Chain with WIN SOURCE Solutions

-  Global Sourcing Solution
-  Obsolete Management
-  Cost Control Management
-  Shortage Management
-  Alternative Solution
-  Excess Inventory Management