



**THE DATASHEET OF
TSM-105-01-L-SH**



TX7364 3-Level, 64-Channel Transmitter with On-Chip Beamformer, T/R Switch

1 Features

- Transmitter supports:
 - 64-channel 3-level pulser and active transmit/receive (T/R) switch
- 3-level pulser:
 - Maximum output voltage: $\pm 100\text{V}$
 - Minimum output voltage: $\pm 1\text{V}$
 - Maximum output current: 1A
 - True return to zero to discharge output to ground
 - Second harmonic of -40dBc at 5MHz
 - -3-dB Bandwidth with $400\Omega \parallel 125\text{pF}$ load
 - 22MHz for a $\pm 100\text{-V}$ supply
 - Very low receive power: 0.1 mW/ch
- Active transmit/receive (T/R) switch with:
 - Turn on resistance of 26Ω
 - Turn on and Turn off time: 100ns
 - Transient glitch: 10mV_{PP}
- On-chip beam former with:
 - Channel based T/R switch on and off controls
 - Delay resolution: half beamformer clock period, minimum 2.5ns
 - Maximum delay: 2^{14} beamformer clock period
 - Maximum beamformer clockspeed: 200MHz
 - On-Chip RAM for pattern and delay profile
 - One 512×32 memory to store beam-former pattern and delay for a group of 4 channels
 - Global repeat feature present, enabling long duration patterns
- High-speed (400 MHz maximum), 2-lane LVDS serial programming interface.
 - Low programming time: $\approx 2.5 \mu\text{s}$ for delay profile update
 - 32-bit Checksum to detect wrong SPI writes
- Supports CMOS serial programming interface (50 MHz maximum)
- High reliability features:
 - Internal temperature sensor and automatic thermal shutdown
 - No specific power sequencing requirement
 - Error flag register to detect faulty conditions
 - Integrated passives for the floating supplies and bias voltages
 - Small package: FC-BGA-196 (12 mm \times 12 mm) with 0.8-mm pitch

3 Description

TX7364 is a highly integrated, high-performance transmitter device for ultrasound imaging system. The device has total 64 pulser circuits, 64 transmit/receive switches (referred as T/R or TR switches) and supports on-chip beamformer (TxBF). The device also integrates on-chip floating power supplies that reduce the number of required high voltage power supplies.

TX7364 has a pulser circuit that generates three-level high voltage pulses (up to $\pm 100\text{ V}$) that is used to excite multiple channels of an ultrasound transducer. The device supports total 64 outputs. The maximum output current is 1A.

Device can be used as a transmitter solution for many applications like ultrasound imaging, non-destructive testing, SONAR, LIDAR, marine navigation system, brain imaging systems and so on.

Package Information

PART NUMBER	PACKAGE ⁽¹⁾	BODY SIZE (NOM)
TX7364	FC-BGA-196	12.0 mm \times 12.0 mm

- (1) For all available packages, see the orderable addendum at the end of the data sheet.

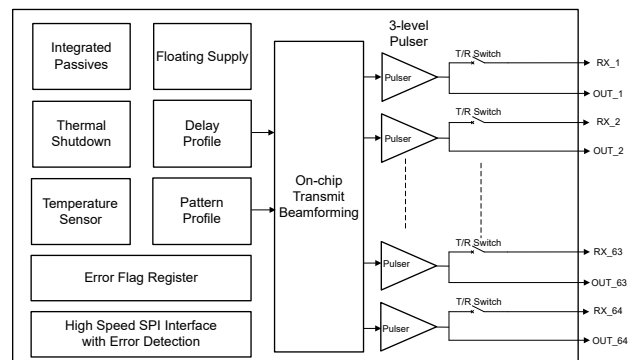

Simplified Block Diagram

2 Applications

- Ultrasound imaging system
- Piezoelectric driver
- In-probe ultrasound imaging



Table of Contents

1 Features	1	4.4 Trademarks.....	3
2 Applications	1	4.5 Electrostatic Discharge Caution.....	3
3 Description	1	4.6 Glossary.....	3
4 Device and Documentation Support	3	5 Revision History	3
4.1 Documentation Support.....	3	6 Mechanical, Packaging, and Orderable Information	3
4.2 Receiving Notification of Documentation Updates.....	3	6.1 Package Option Addendum.....	7
4.3 Support Resources.....	3		

4 Device and Documentation Support

TI offers an extensive line of development tools. Tools and software to evaluate the performance of the device, generate code, and develop solutions are listed below.

4.1 Documentation Support

Abbreviation	Comment
PRT	Pulse Repetition Time. Represent TR_BF_SYNC period
PRF	Pulse Repetition Frequency. Represent TR_BF_SYNC frequency
Receive Mode	Duration in which T/R switch of all the channels are in ON state
High Voltage Supplies	AVDDP_HV and AVDDM_HV are collectively referred as high voltage supplies
Low Voltage Supplies	AVDDP_5, AVDDM_5, and AVDDP_1P8 supplies are collectively referred as low voltage supplies
SPI	Serial program interface

4.2 Receiving Notification of Documentation Updates

To receive notification of documentation updates, navigate to the device product folder on [ti.com](https://www.ti.com). Click on *Notifications* to register and receive a weekly digest of any product information that has changed. For change details, review the revision history included in any revised document.

4.3 Support Resources

[TI E2E™ support forums](#) are an engineer's go-to source for fast, verified answers and design help — straight from the experts. Search existing answers or ask your own question to get the quick design help you need.

Linked content is provided "AS IS" by the respective contributors. They do not constitute TI specifications and do not necessarily reflect TI's views; see TI's [Terms of Use](#).

4.4 Trademarks

TI E2E™ is a trademark of Texas Instruments.
All trademarks are the property of their respective owners.

4.5 Electrostatic Discharge Caution



This integrated circuit can be damaged by ESD. Texas Instruments recommends that all integrated circuits be handled with appropriate precautions. Failure to observe proper handling and installation procedures can cause damage.

ESD damage can range from subtle performance degradation to complete device failure. Precision integrated circuits may be more susceptible to damage because very small parametric changes could cause the device not to meet its published specifications.

4.6 Glossary

[TI Glossary](#) This glossary lists and explains terms, acronyms, and definitions.

5 Revision History

NOTE: Page numbers for previous revisions may differ from page numbers in the current version.

DATE	REVISION	NOTES
April 2024	*	Initial Release

6 Mechanical, Packaging, and Orderable Information

The following pages include mechanical, packaging, and orderable information. This information is the most current data available for the designated devices. This data is subject to change without notice and revision of this document. For browser-based versions of this data sheet, refer to the left-hand navigation.

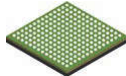
ACP0196A  **PACKAGE OUTLINE**
FCBGA - 1.321 mm max height
BALL GRID ARRAY

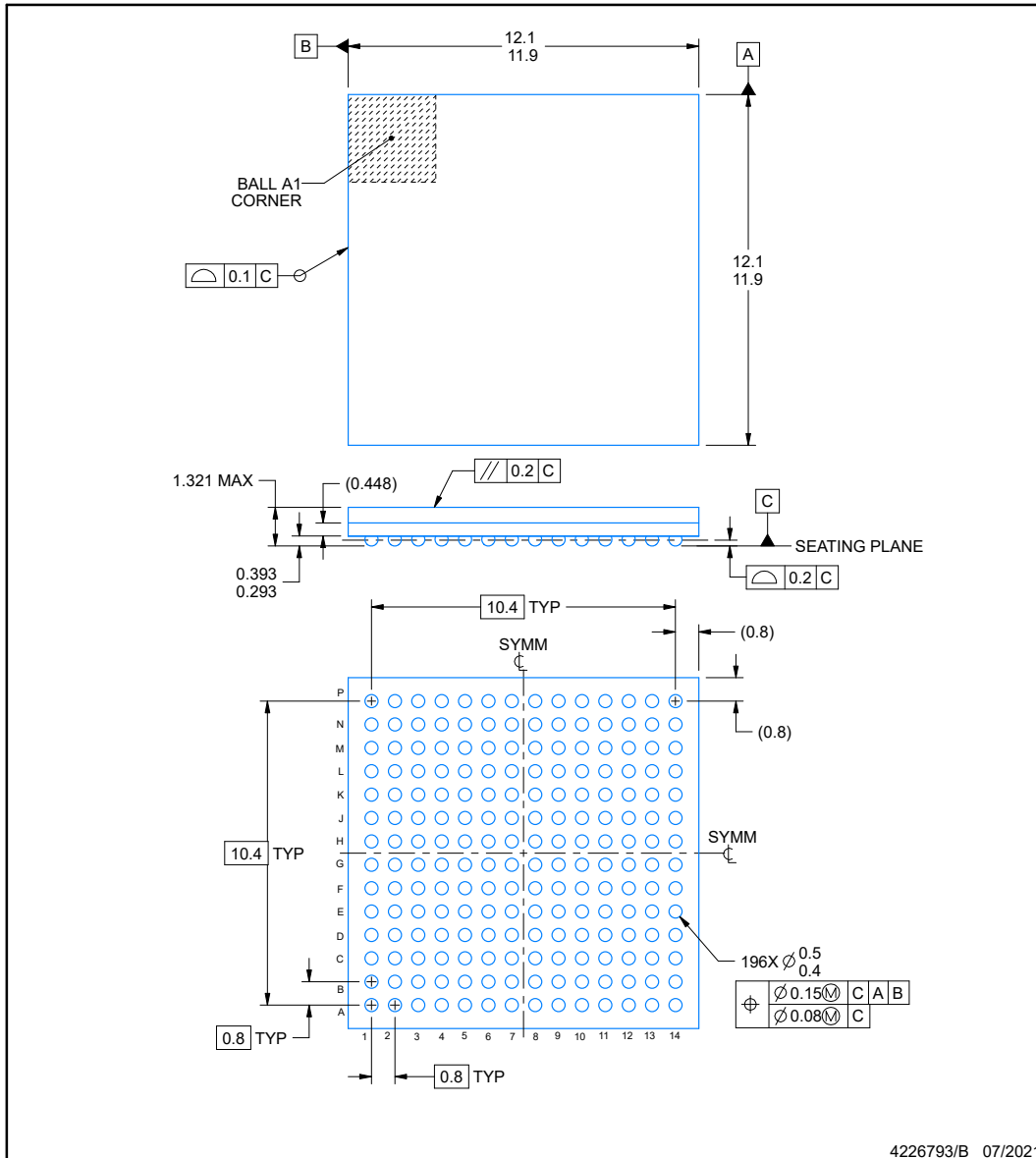

NOTES:

1. All linear dimensions are in millimeters. Any dimensions in parenthesis are for reference only. Dimensioning and tolerancing per ASME Y14.5M.
2. This drawing is subject to change without notice.

EXAMPLE BOARD LAYOUT

ACP0196A

FCBGA - 1.321 mm max height

BALL GRID ARRAY

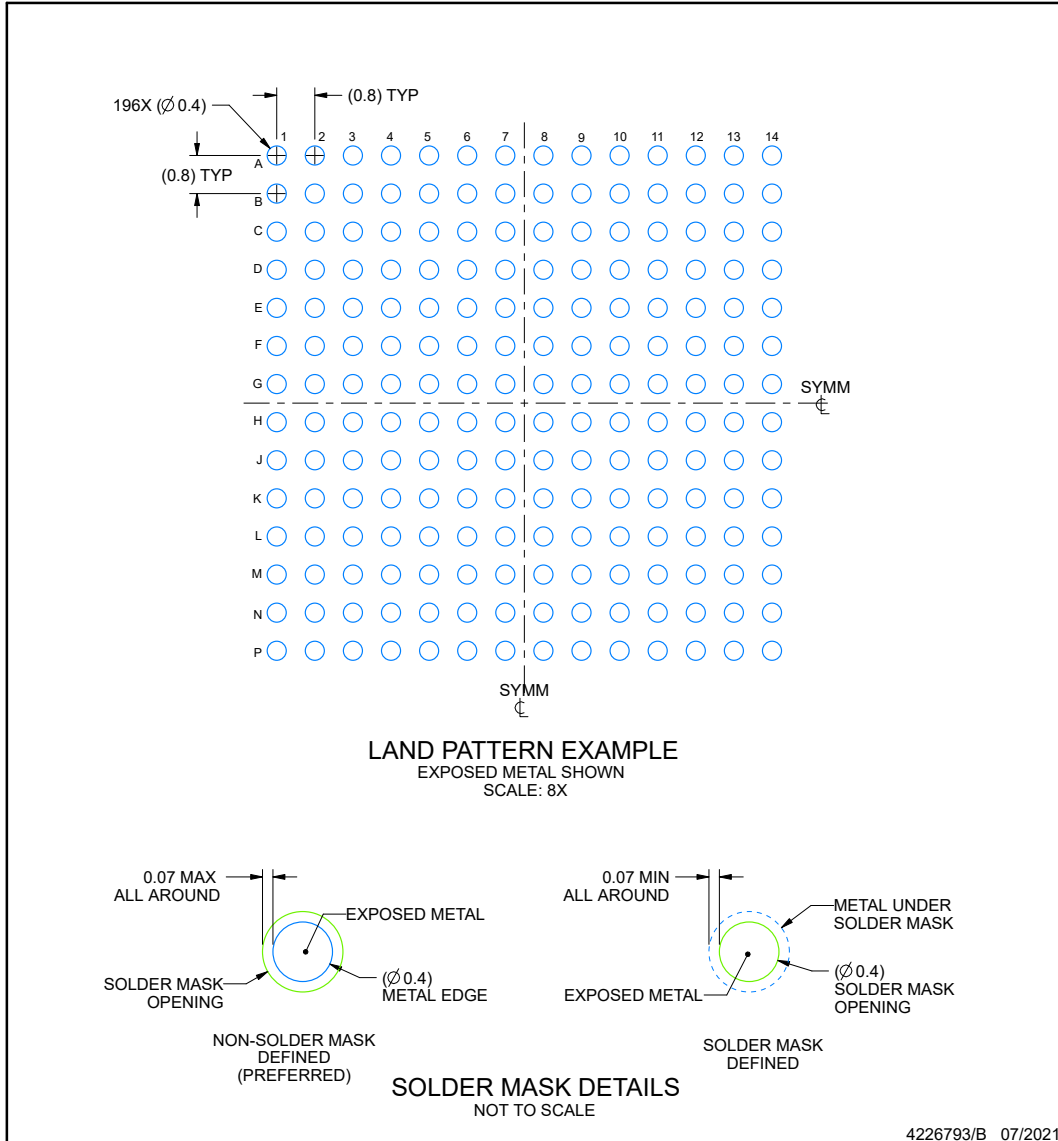

NOTES: (continued)

- Final dimensions may vary due to manufacturing tolerance considerations and also routing constraints. For information, see Texas Instruments literature number SPRAA99 (www.ti.com/lit/spraa99).

EXAMPLE STENCIL DESIGN

ACP0196A

FCBGA - 1.321 mm max height

BALL GRID ARRAY

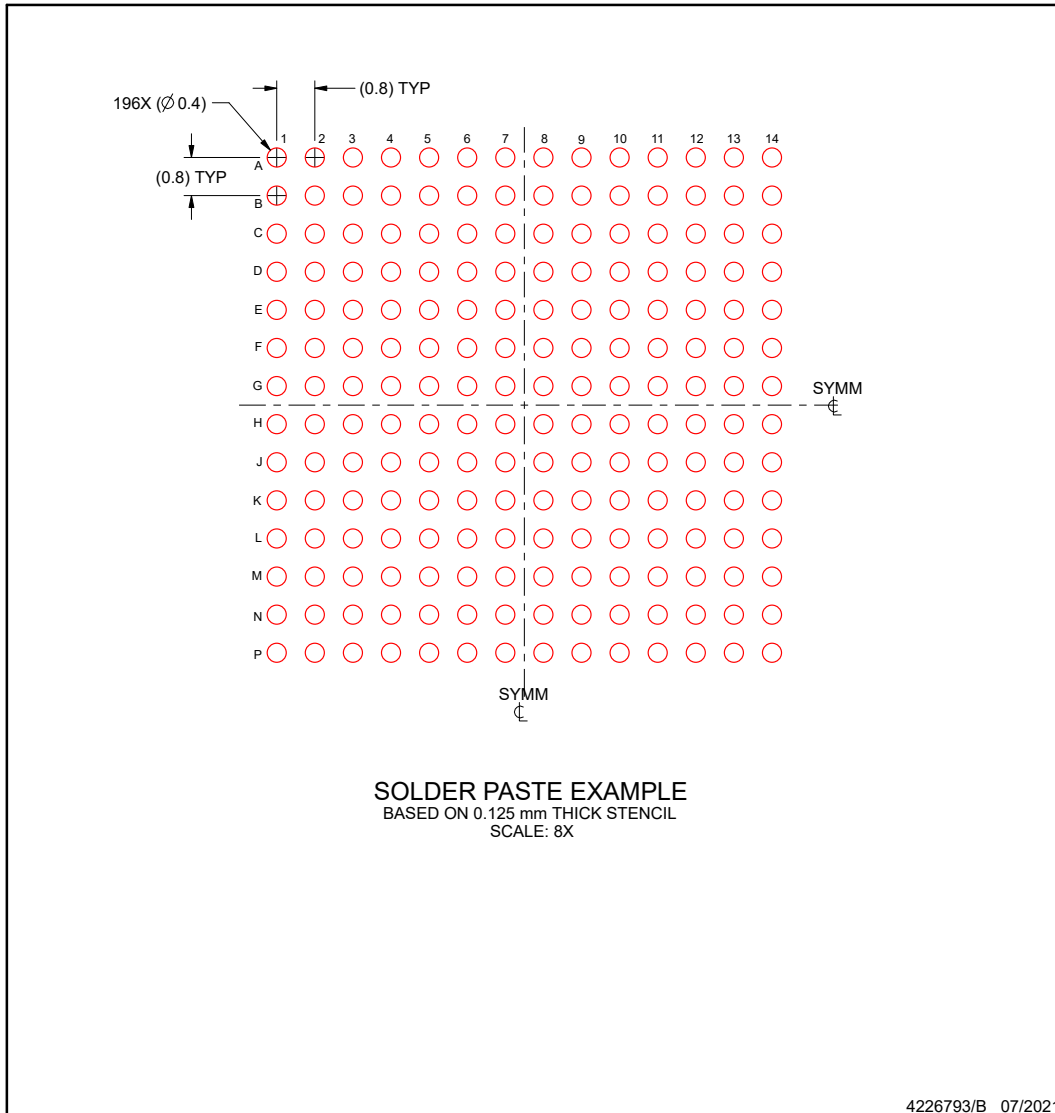

NOTES: (continued)

4. Laser cutting apertures with trapezoidal walls and rounded corners may offer better paste release.

6.1 Package Option Addendum

Packaging Information

Orderable Device	Status ⁽¹⁾	Package Type	Package Drawing	Pins	Package Qty	Eco Plan ⁽²⁾	Lead/Ball Finish ⁽⁶⁾	MSL Peak Temp ⁽³⁾	Op Temp (°C)	Device Marking ⁽⁴⁾ ⁽⁵⁾
TX7364ACP	ACTIVE	FCCSP	ACP	196	189	RoHS & Green	SNAGCU	Level-3-26 0C-168 HR	0°C to 70°C	TX7364

- (1) The marketing status values are defined as follows:
ACTIVE: Product device recommended for new designs.
LIFEBUY: TI has announced that the device will be discontinued, and a lifetime-buy period is in effect.
NRND: Not recommended for new designs. Device is in production to support existing customers, but TI does not recommend using this part in a new design.
PRE_PROD Unannounced device, not in production, not available for mass market, nor on the web, samples not available.
PREVIEW: Device has been announced but is not in production. Samples may or may not be available.
OBSOLETE: TI has discontinued the production of the device.
- (2) Eco Plan - The planned eco-friendly classification: Pb-Free (RoHS), Pb-Free (RoHS Exempt), or Green (RoHS & no Sb/Br) - please check www.ti.com/productcontent for the latest availability information and additional product content details.
TBD: The Pb-Free/Green conversion plan has not been defined.
Pb-Free (RoHS): TI's terms "Lead-Free" or "Pb-Free" mean semiconductor products that are compatible with the current RoHS requirements for all 6 substances, including the requirement that lead not exceed 0.1% by weight in homogeneous materials. Where designed to be soldered at high temperatures, TI Pb-Free products are suitable for use in specified lead-free processes.
Pb-Free (RoHS Exempt): This component has a RoHS exemption for either 1) lead-based flip-chip solder bumps used between the die and package, or 2) lead-based die adhesive used between the die and leadframe. The component is otherwise considered Pb-Free (RoHS compatible) as defined above.
Green (RoHS & no Sb/Br): TI defines "Green" to mean Pb-Free (RoHS compatible), and free of Bromine (Br) and Antimony (Sb) based flame retardants (Br or Sb do not exceed 0.1% by weight in homogeneous material).
- (3) MSL, Peak Temp. -- The Moisture Sensitivity Level rating according to the JEDEC industry standard classifications, and peak solder temperature.
- (4) There may be additional marking, which relates to the logo, the lot trace code information, or the environmental category on the device.
- (5) Multiple Device markings will be inside parentheses. Only one Device Marking contained in parentheses and separated by a "~" will appear on a device. If a line is indented then it is a continuation of the previous line and the two combined represent the entire Device Marking for that device.
- (6) Lead/Ball Finish - Orderable Devices may have multiple material finish options. Finish options are separated by a vertical ruled line. Lead/Ball Finish values may wrap to two lines if the finish value exceeds the maximum column width.

Important Information and Disclaimer: The information provided on this page represents TI's knowledge and belief as of the date that it is provided. TI bases its knowledge and belief on information provided by third parties, and makes no representation or warranty as to the accuracy of such information. Efforts are underway to better integrate information from third parties. TI has taken and continues to take reasonable steps to provide representative and accurate information but may not have conducted destructive testing or chemical analysis on incoming materials and chemicals. TI and TI suppliers consider certain information to be proprietary, and thus CAS numbers and other limited information may not be available for release.

In no event shall TI's liability arising out of such information exceed the total purchase price of the TI part(s) at issue in this document sold by TI to Customer on an annual basis.

PACKAGING INFORMATION

Orderable part number	Status (1)	Material type (2)	Package Pins	Package qty Carrier	RoHS (3)	Lead finish/ Ball material (4)	MSL rating/ Peak reflow (5)	Op temp (°C)	Part marking (6)
TX7364ACP	Active	Production	FCCSP (ACP) 196	160 JEDEC TRAY (5+1)	-	Call TI Snagcu	Level-3-260C-168 HR	0 to 70	TX7364

(1) **Status:** For more details on status, see our [product life cycle](#).

(2) **Material type:** When designated, preproduction parts are prototypes/experimental devices, and are not yet approved or released for full production. Testing and final process, including without limitation quality assurance, reliability performance testing, and/or process qualification, may not yet be complete, and this item is subject to further changes or possible discontinuation. If available for ordering, purchases will be subject to an additional waiver at checkout, and are intended for early internal evaluation purposes only. These items are sold without warranties of any kind.

(3) **RoHS values:** Yes, No, RoHS Exempt. See the [TI RoHS Statement](#) for additional information and value definition.

(4) **Lead finish/Ball material:** Parts may have multiple material finish options. Finish options are separated by a vertical ruled line. Lead finish/Ball material values may wrap to two lines if the finish value exceeds the maximum column width.

(5) **MSL rating/Peak reflow:** The moisture sensitivity level ratings and peak solder (reflow) temperatures. In the event that a part has multiple moisture sensitivity ratings, only the lowest level per JEDEC standards is shown. Refer to the shipping label for the actual reflow temperature that will be used to mount the part to the printed circuit board.

(6) **Part marking:** There may be an additional marking, which relates to the logo, the lot trace code information, or the environmental category of the part.

Multiple part markings will be inside parentheses. Only one part marking contained in parentheses and separated by a "~" will appear on a part. If a line is indented then it is a continuation of the previous line and the two combined represent the entire part marking for that device.

Important Information and Disclaimer: The information provided on this page represents TI's knowledge and belief as of the date that it is provided. TI bases its knowledge and belief on information provided by third parties, and makes no representation or warranty as to the accuracy of such information. Efforts are underway to better integrate information from third parties. TI has taken and continues to take reasonable steps to provide representative and accurate information but may not have conducted destructive testing or chemical analysis on incoming materials and chemicals. TI and TI suppliers consider certain information to be proprietary, and thus CAS numbers and other limited information may not be available for release.

In no event shall TI's liability arising out of such information exceed the total purchase price of the TI part(s) at issue in this document sold by TI to Customer on an annual basis.

IMPORTANT NOTICE AND DISCLAIMER

TI PROVIDES TECHNICAL AND RELIABILITY DATA (INCLUDING DATASHEETS), DESIGN RESOURCES (INCLUDING REFERENCE DESIGNS), APPLICATION OR OTHER DESIGN ADVICE, WEB TOOLS, SAFETY INFORMATION, AND OTHER RESOURCES "AS IS" AND WITH ALL FAULTS, AND DISCLAIMS ALL WARRANTIES, EXPRESS AND IMPLIED, INCLUDING WITHOUT LIMITATION ANY IMPLIED WARRANTIES OF MERCHANTABILITY, FITNESS FOR A PARTICULAR PURPOSE OR NON-INFRINGEMENT OF THIRD PARTY INTELLECTUAL PROPERTY RIGHTS.

These resources are intended for skilled developers designing with TI products. You are solely responsible for (1) selecting the appropriate TI products for your application, (2) designing, validating and testing your application, and (3) ensuring your application meets applicable standards, and any other safety, security, regulatory or other requirements.

These resources are subject to change without notice. TI grants you permission to use these resources only for development of an application that uses the TI products described in the resource. Other reproduction and display of these resources is prohibited. No license is granted to any other TI intellectual property right or to any third party intellectual property right. TI disclaims responsibility for, and you fully indemnify TI and its representatives against any claims, damages, costs, losses, and liabilities arising out of your use of these resources.

TI's products are provided subject to [TI's Terms of Sale](#), [TI's General Quality Guidelines](#), or other applicable terms available either on [ti.com](#) or provided in conjunction with such TI products. TI's provision of these resources does not expand or otherwise alter TI's applicable warranties or warranty disclaimers for TI products. Unless TI explicitly designates a product as custom or customer-specified, TI products are standard, catalog, general purpose devices.



TI objects to and rejects any additional or different terms you may propose.

Copyright © 2026, Texas Instruments Incorporated

Last updated 10/2025

Looking for pricing, stock, or lifecycle information?

Click below to explore more details on WIN SOURCE:

-  [View TSM-105-01-L-SH on WIN SOURCE](#)
-  [Samtec Inc. Information](#)

Optimize Your Supply Chain with WIN SOURCE Solutions

-  Global Sourcing Solution
-  Obsolete Management
-  Cost Control Management
-  Shortage Management
-  Alternative Solution
-  Excess Inventory Management