



**THE DATASHEET OF  
RT4831AWSC**



# Features

# Unregulated Converters

- Industry standard pinout
- 1kVDC/1s or 2kVDC/1s isolation
- UL94 V-0 package material
- Fully encapsulated
- Efficiency up to 85%



## RO

**1 Watt**  
**SIP4**  
**Single Output**



### Description

The RO DC/DC converters are typically used in general purpose power isolation and voltage matching applications, and feature a full industrial operating temperature range of -40°C to +85°C without derating.

### Selection Guide

Part Number	nom. Input Voltage [VDC]	Output Voltage [VDC]	Output Current [mA]	Efficiency typ. <sup>(1)</sup> [%]	max. Capacitive Load <sup>(2)</sup> [μF]
RO-xx3.3S <sup>(3,4)</sup>	3.3, 5, 12, 15, 24	3.3	303	75	2200
RO-xx05S <sup>(3,4)</sup>	3.3, 5, 12, 15, 24	5	200	78-80	1000
RO-xx09S <sup>(3,4)</sup>	3.3, 5, 12, 15, 24	9	111	78-80	1000
RO-xx12S <sup>(3,4)</sup>	3.3, 5, 12, 15, 24	12	83	80-84	470
RO-xx15S <sup>(3,4)</sup>	3.3, 5, 12, 15, 24	15	66	80-84	470
RO-xx24S <sup>(3,4)</sup>	3.3, 5, 12, 15, 24	24	42	78-85	220

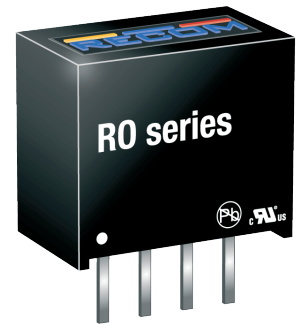

### Notes:

- Note1: Efficiency is tested at nominal input and full load at +25°C ambient  
 Note2: Max Cap Load is tested at nominal input and full resistive load and is defined as the capacitive load that will allow start up in under 1s without damage to the converter



### Model Numbering

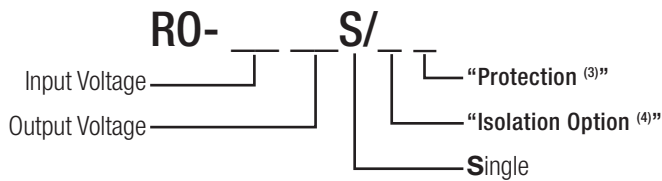

### Notes:

- Note3: standard part is without continuous short circuit protection  
 add suffix „/P“ for continuous short circuit protection  
 Note4: add suffix „/H“ for 2kVDC/1s isolation  
 or add suffix „/HP“ for continuous short circuit protection and 2kVDC/1s isolation

UL60950-1 certified  
 CAN/CSA-C22.2 No 60950-1 certified  
 EN60950-1 certified  
 IEC60950-1 certified  
 EN55032 compliant  
 CB report

### Ordering Examples:

RO-123.3S/P: 12VDC Input Voltage, 3.3VDC Output Voltage, Single Output with continuous short circuit protection  
 RO-0509S/HP: 5VDC Input Voltage, 9VDC Output Voltage, Single Output with 2kVDC/1s Isolation and continuous short circuit protection

**Specifications** (measured @ Ta= 25°C, nom. Vin, full load unless otherwise stated)

**BASIC CHARACTERISTICS**

Parameter	Condition	Min.	Typ.	Max.
Internal Input Filter				capacitor
Input Voltage Range			±10%	
Minimum Load		0%		
Internal Operating Frequency		50kHz	100kHz	105kHz
Output Ripple and Noise	20MHz BW			100mVp-p

**Efficiency vs. Load**

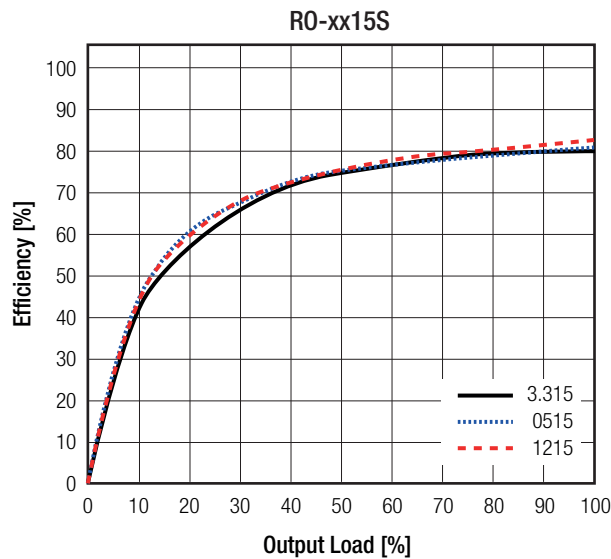
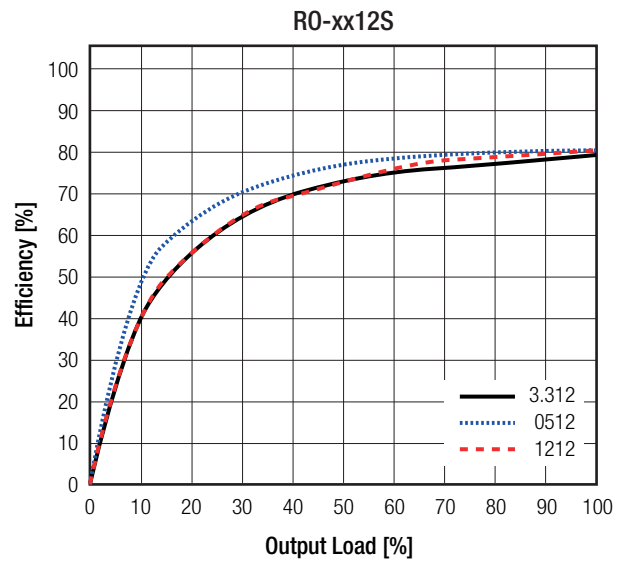
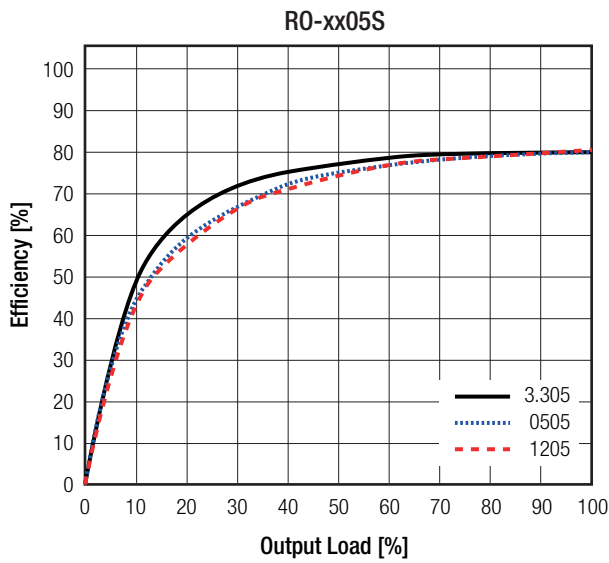

**REGULATIONS**

Parameter	Condition	Value
Output Accuracy		-2.0% typ. / ±5.0% max.
Line Regulation	low line to high line	±1.2% of 1.0% Vin typ.

continued on next page

**Specifications** (measured @ Ta= 25°C, nom. Vin, full load unless otherwise stated)

Parameter	Condition		Value
Load Regulation <sup>(5)</sup>	10% to 100% load	3.3Vout	20.0% max.
		5Vout	15.0% max.
		12, 15, 24Vout	10.0% max.

**Notes:**

Note5: Operation below 10% load will not harm the converter, but specifications may not be met

**Tolerance Envelope**

**RO-xx3.3S and RO-xx05S**

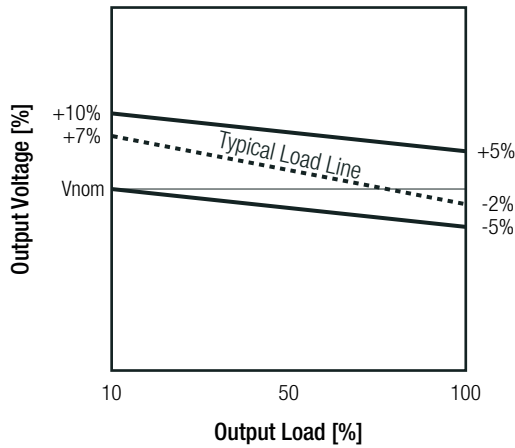

**RO-xx12S and RO-xx15S**

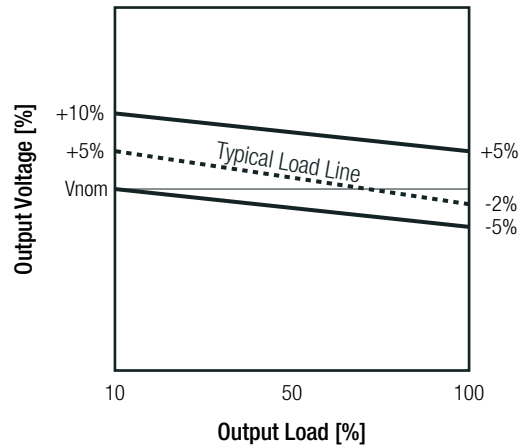

**Deviation vs. Load**

**RO-xx05S**

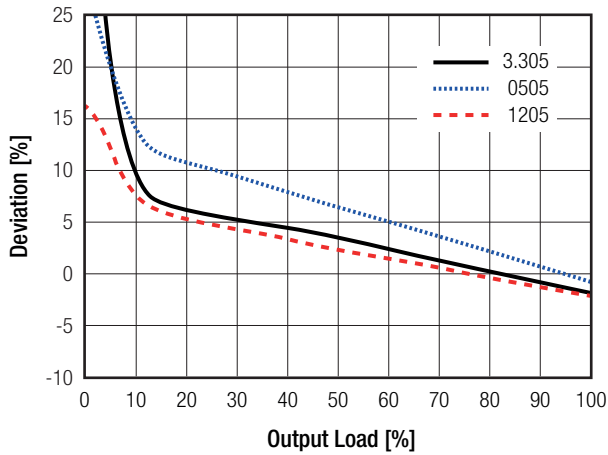

**RO-xx12S**

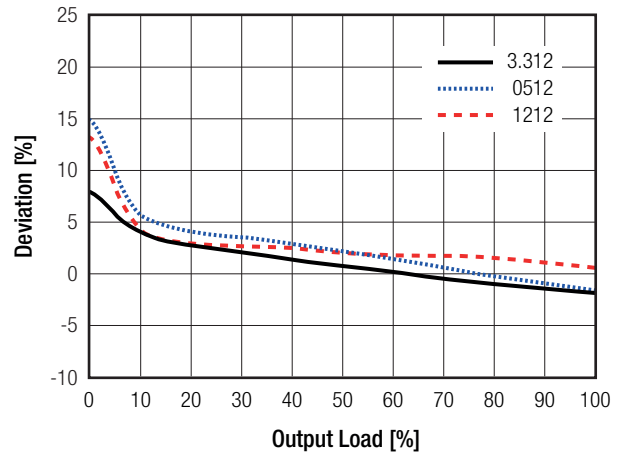

**RO-xx15S**

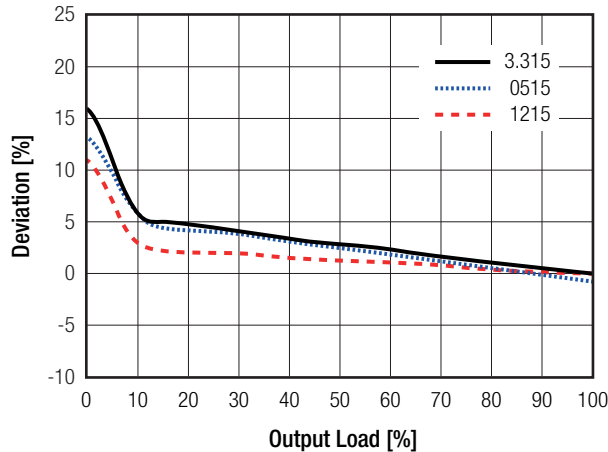

**Specifications** (measured @ Ta= 25°C, nom. Vin, full load unless otherwise stated)

**PROTECTIONS**

Parameter	Type		Value
Short Circuit Protection (SCP)	without suffix with suffix "/P"		1 second continuous
Isolation Voltage <sup>(6)</sup>	I/P to O/P	without suffix	tested for 1 second rated for 1 minute 1kVDC 500VAC/60Hz
		with suffix "/H"	tested for 1 second rated for 1 minute 2kVDC 1kVAC/60Hz
Isolation Resistance			10GΩ min.
Isolation Capacitance			20pF min. / 75pF max.
Insulation Grade			basic (IEC/EN60950-1) functional (IEC/EN60601-1)
<p><b>Notes:</b></p> <p>Note6: For repeat Hi-Pot testing, reduce the time and/or the test voltage</p> <p>Note7: Refer to local safety regulations if input over-current protection is also required. Recommended fuse: slow blow type</p>			

**ENVIRONMENTAL**

Parameter	Condition		Value
Operating Temperature Range	full load (see graph)		-40°C to +85°C
Maximum Case Temperature			+110°C
Temperature Coefficient			±0.03%/K typ.
Thermal Impedance			67K/W
Operating Altitude			2000m (IEC/EN60950-1) 3000m (IEC/EN60601-1)
Operating Humidity	non-condensing		95% RH max.
Pollution Degree			PD2
MTBF	according to MIL-HDBK-217F, G.B.	+25°C	11800 x 10 <sup>3</sup> hours
		+85°C	4800 x 10 <sup>3</sup> hours

**Derating Graph**

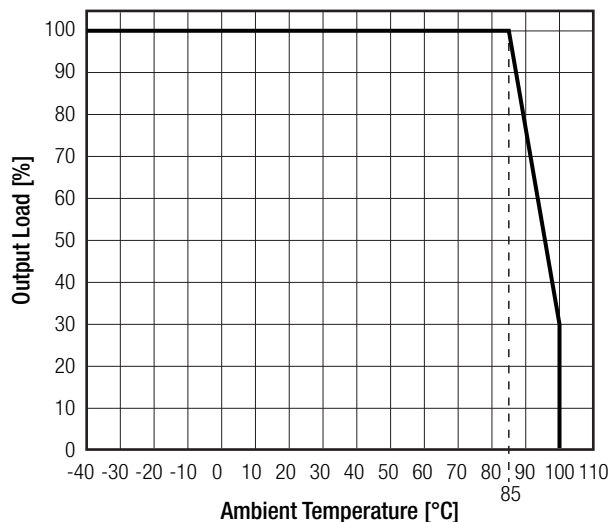

**Specifications** (measured @ Ta= 25°C, nom. Vin, full load unless otherwise stated)

**SAFETY AND CERTIFICATIONS**

Certificate Type (Safety)	Report / File Number	Standard
Information Technology Equipment, General Requirements for Safety	LVD1602031	IEC60950-1:2005, 2nd Edition + A2:2013 EN60950-1:2006 + A2:2013
Information Technology Equipment, General Requirements for Safety	E358085-A4-UL	UL60950-1, 2nd Edition:2007 CAN/CSA C22.2 No. 60950-1-03, 2nd Edition:2007
Information Technology Equipment, General Requirements for Safety (CB)	E322406-A4-CB-1	IEC60950-1:2005, 2nd Edition
Medical electrical equipment Part 1: General requirements for basic safety and essential performance	WD-SE-R-180677-A0	EN60601-1:2006 + A12:2014 IEC60601-1:2005 + A1:2012, 3rd Edition
EAC	RU-AT.49.09571	TP TC 004/2011
RoHS 2		RoHS-2011/65/EU + AM-2015/863

**EMC Compliance**

EMC Compliance	Condition	Standard / Criterion
Electromagnetic compatibility of multimedia equipment - Emission requirements	with external filter (see filter suggestion below)	EN55032, Class A and B

**EMC Filter Suggestion according to EN55032**

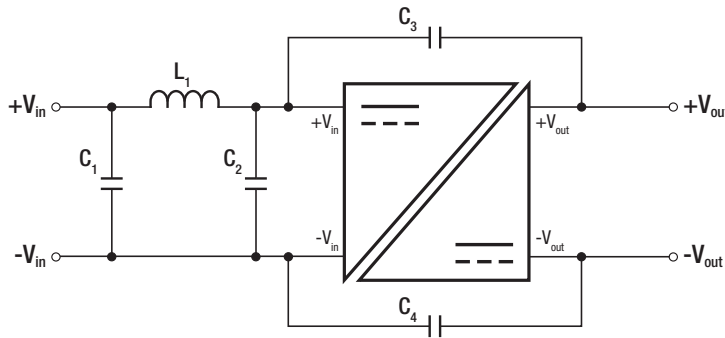

**Component List Class A**

MODEL	C1	L1	C2	C4 (safety)
RO-0505S	10µF 100V MLCC	N/A	1nF 50V MLCC	N/A
RO-1205S				2.2nF
RO-2405S				N/A

**Component List Class B**

MODEL	C1	L1	C3 (safety)	C4 (safety)
RO-0505S	10µF 100V MLCC	<a href="#">22µH choke</a> <a href="#">RLS-226</a>	1nF	2.2nF
RO-1205S				
RO-2405S				

**Notes:**

Note8: Filter suggestions are valid for indicated part numbers only. For other part numbers, please contact RECOM tech support for advice

**DIMENSION AND PHYSICAL CHARACTERISTICS**

Parameter	Type	Value
Material	case potting PCB	non-conductive black plastic, (UL94V-0) epoxy, (UL94V-0) FR4, (UL94V-0)
Dimension (LxWxH)		11.5 x 6.0 x 10.0mm
Weight		1.4g typ.

continued on next page

**Specifications** (measured @ Ta= 25°C, nom. Vin, full load unless otherwise stated)

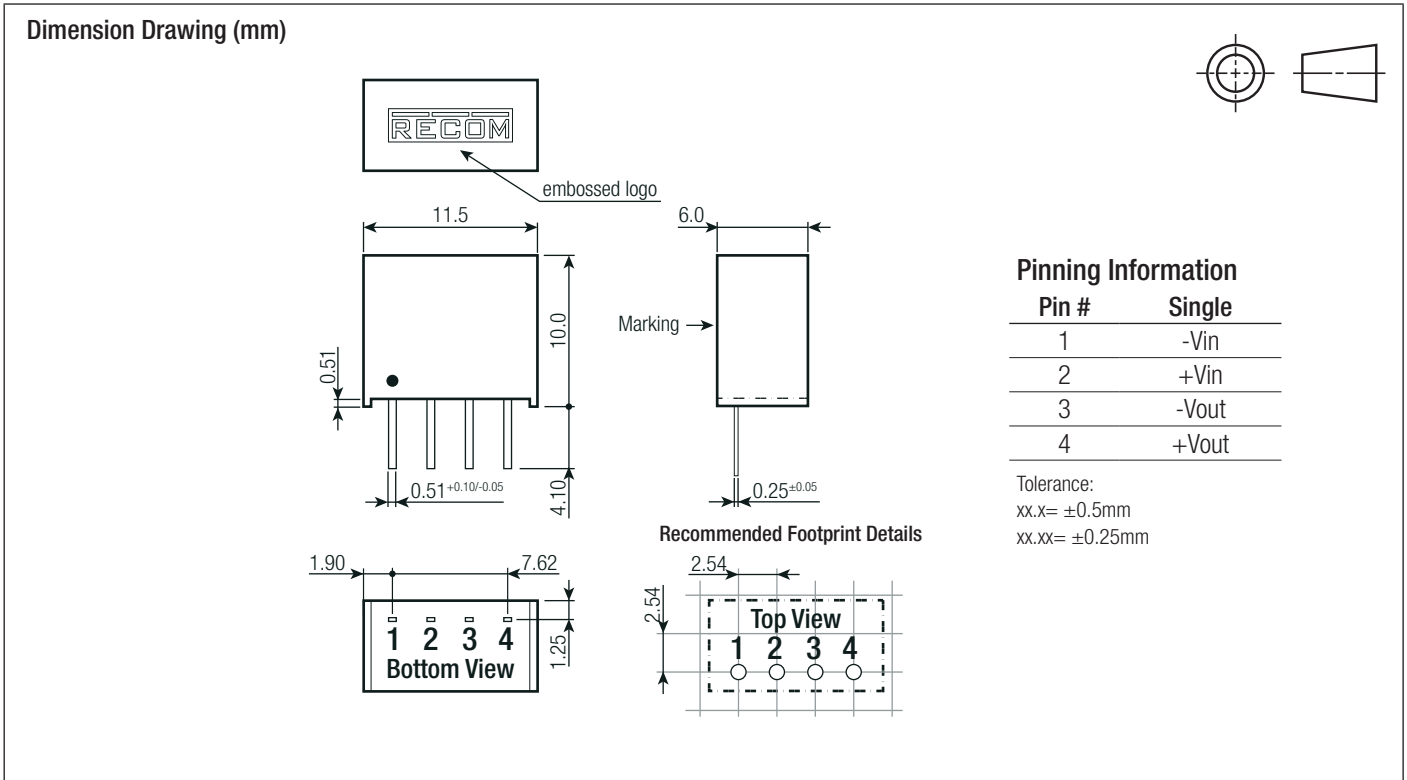

**INSTALLATION AND APPLICATION**

**Typical Application**

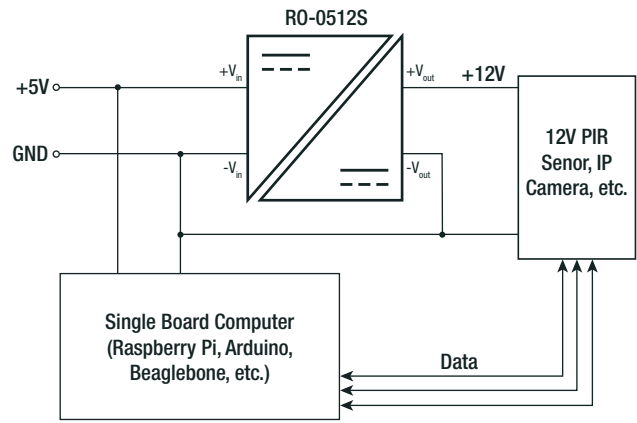



**PACKAGING INFORMATION**

Parameter	Type	Value
Packaging Dimension (LxWxH)	tube	520.0 x 16.0 x 9.0mm
Packaging Quantity	tube	42pcs
Storage Temperature Range		-55°C to +125°C
Storage Humidity	non-condensing	95% RH max.

The product information and specifications may be subject to changes even without prior written notice. The product has been designed for various applications; its suitability lies in the responsibility of each customer. The products are not authorized for use in safety-critical applications without RECOM's explicit written consent. A safety-critical application is an application where a failure may reasonably be expected to endanger or cause loss of life, inflict bodily harm or damage property. The applicant shall indemnify and hold harmless RECOM, its affiliated companies and its representatives against any damage claims in connection with the unauthorized use of RECOM products in such safety-critical applications.

## Looking for pricing, stock, or lifecycle information?

Click below to explore more details on WIN SOURCE:

-  [View RT4831AWSC on WIN SOURCE](#)
-  [Richtek USA Inc. Information](#)

## Optimize Your Supply Chain with WIN SOURCE Solutions

-  Global Sourcing Solution
-  Obsolete Management
-  Cost Control Management
-  Shortage Management
-  Alternative Solution
-  Excess Inventory Management