



# THE DATASHEET OF MSPM0C1104SDSGR



# Notice for TAIYO YUDEN Products

Please read this notice before using the TAIYO YUDEN products.

## ⚠ REMINDERS

### Product Information in this Catalog

Product information in this catalog is as of March 2023. All of the contents specified herein and production status of the products listed in this catalog are subject to change without notice due to technical improvement of our products, etc. Therefore, please check for the latest information carefully before practical application or use of our products.

Please note that TAIYO YUDEN shall not be in any way responsible for any damages and defects in products or equipment incorporating our products, which are caused under the conditions other than those specified in this catalog or individual product specification sheets.

### Approval of Product Specifications

Please contact TAIYO YUDEN for further details of product specifications as the individual product specification sheets are available. When using our products, please be sure to approve our product specifications or make a written agreement on the product specification with TAIYO YUDEN in advance.

### Pre-Evaluation in the Actual Equipment and Conditions

Please conduct validation and verification of our products in actual conditions of mounting and operating environment before using our products.

### Limited Application

#### 1. Equipment Intended for Use

The products listed in this catalog are intended for general-purpose and standard use in general electronic equipment for consumer (e.g., AV equipment, OA equipment, home electric appliances, office equipment, information and communication equipment including, without limitation, mobile phone, and PC) and other equipment specified in this catalog or the individual product specification sheets, or the equipment approved separately by TAIYO YUDEN.

TAIYO YUDEN has the product series intended for use in the following equipment. Therefore, when using our products for these equipment, please check available applications specified in this catalog or the individual product specification sheets and use the corresponding products.

Application	Product Series		Quality Grade <sup>*3</sup>
	Equipment <sup>*1</sup>	Category (Part Number Code <sup>*2</sup> )	
Automotive	Automotive Electronic Equipment (POWERTRAIN, SAFETY)	A	1
	Automotive Electronic Equipment (BODY & CHASSIS, INFOTAINMENT)	C	2
Industrial	Telecommunications Infrastructure and Industrial Equipment	B	2
Medical	Medical Devices classified as GHTF Class C (Japan Class III)	M	2
	Medical Devices classified as GHTF Classes A or B (Japan Classes I or II)	L	3
Consumer	General Electronic Equipment	S	3
	Only for Mobile Devices <sup>*4</sup>	E	4

\*Notes: 1. Based on the general specifications required for electronic components for such equipment, which are recognized by TAIYO YUDEN, the use of each product series for the equipment is recommended. Please be sure to contact TAIYO YUDEN before using our products for equipment other than those covered by the product series.

2. On each of our part number, the 2nd code from the left is a code indicating the "Category" as shown in the above table. For details, please check the explanatory materials regarding the part numbering system of each of our products.

3. Each product series is assigned a "Quality Grade" from 1 to 4 in order of higher quality. Please do not incorporate a product into any equipment with a higher Quality Grade than the Quality Grade of such product without the prior written consent of TAIYO YUDEN.

4. The applications covered by this product series are limited to mobile devices (smartphone, tablet PC, smartwatch, handheld game console, etc.) among general electronic equipment for consumer. The design, specifications and operating environment, etc. differ from those of the product series for "General Electronic Equipment" (Category: S), so please check the individual product specification sheets for details. The product series for "General Electronic Equipment" (Category: S) can also be used for mobile devices.

▶ This catalog contains the typical specification only due to the limitation of space. When you consider the purchase of our products, please check our product specification sheets. For details of each product (characteristics graph, reliability information, precautions for use, and so on), see our website (<http://www.ty-top.com/>).

## 2. Equipment Requiring Inquiry

Please be sure to contact TAIYO YUDEN for further information before using the products listed in this catalog for the following equipment (excluding intended equipment as specified in this catalog or the individual product specification sheets) which may cause loss of human life, bodily injury, serious property damage and/or serious public impact due to a failure or defect of the products and/or malfunction attributed thereto.

- (1) Transportation equipment (automotive powertrain control system, train control system, and ship control system, etc.)
- (2) Traffic signal equipment
- (3) Disaster prevention equipment, crime prevention equipment
- (4) Medical devices classified as GHTF Class C (Japan Class III)
- (5) Highly public information network equipment, data-processing equipment (telephone exchange, and base station, etc.)
- (6) Any other equipment requiring high levels of quality and/or reliability equal to the equipment listed above

## 3. Equipment Prohibited for Use

Please do not incorporate our products into the following equipment requiring extremely high levels of safety and/or reliability.

- (1) Aerospace equipment (artificial satellite, rocket, etc.)
- (2) Aviation equipment \*1
- (3) Medical devices classified as GHTF Class D (Japan Class IV), implantable medical devices \*2
- (4) Power generation control equipment (nuclear power, hydroelectric power, thermal power plant control system, etc.)
- (5) Undersea equipment (submarine repeating equipment, etc.)
- (6) Military equipment
- (7) Any other equipment requiring extremely high levels of safety and/or reliability equal to the equipment listed above

\*Notes: 1. There is a possibility that our products can be used only for aviation equipment that does not directly affect the safe operation of aircraft (e.g., in-flight entertainment, cabin light, electric seat, cooking equipment) if such use meets requirements specified separately by TAIYO YUDEN. Please be sure to contact TAIYO YUDEN for further information before using our products for such aviation equipment.

2. Implantable medical devices contain not only internal unit which is implanted in a body, but also external unit which is connected to the internal unit.

## 4. Limitation of Liability

Please note that unless you obtain prior written consent of TAIYO YUDEN, TAIYO YUDEN shall not be in any way responsible for any damages incurred by you or third parties arising from use of the products listed in this catalog for any equipment that is not intended for use by TAIYO YUDEN, or any equipment requiring inquiry to TAIYO YUDEN or prohibited for use by TAIYO YUDEN as described above.

### ■ Safety Design

When using our products for high safety and/or reliability-required equipment or circuits, please fully perform safety and/or reliability evaluation. In addition, please install (i) systems equipped with a protection circuit and a protection device and/or (ii) systems equipped with a redundant circuit or other system to prevent an unsafe status in the event of a single fault for a failsafe design to ensure safety.

### ■ Intellectual Property Rights

Information contained in this catalog is intended to convey examples of typical performances and/or applications of our products and is not intended to make any warranty with respect to the intellectual property rights or any other related rights of TAIYO YUDEN or any third parties nor grant any license under such rights.

### ■ Limited Warranty

Please note that the scope of warranty for our products is limited to the delivered our products themselves conforming to the product specifications specified in the individual product specification sheets, and TAIYO YUDEN shall not be in any way responsible for any damages resulting from a failure or defect in our products. Notwithstanding the foregoing, if there is a written agreement (e.g., supply and purchase agreement, quality assurance agreement) signed by TAIYO YUDEN and your company, TAIYO YUDEN will warrant our products in accordance with such agreement, provided, however, that our products shall be used for general-purpose and standard use in the equipment specified in this catalog or the individual product specification sheets.

### ■ TAIYO YUDEN's Official Sales Channel

The contents of this catalog are applicable to our products which are purchased from our sales offices or authorized distributors (hereinafter "TAIYO YUDEN's official sales channel"). Please note that the contents of this catalog are not applicable to our products purchased from any seller other than TAIYO YUDEN's official sales channel.

### ■ Caution for Export

Some of our products listed in this catalog may require specific procedures for export according to "U.S. Export Administration Regulations", "Foreign Exchange and Foreign Trade Control Law" of Japan, and other applicable regulations. Should you have any questions on this matter, please contact our sales staff.

▶ This catalog contains the typical specification only due to the limitation of space. When you consider the purchase of our products, please check our product specification sheets. For details of each product (characteristics graph, reliability information, precautions for use, and so on), see our website (<http://www.ty-top.com/>).

# Multilayer Ceramic Capacitors for General Electronic Equipment for Consumer

REFLOW

## PART NUMBER

M	S	A	S	U	3	1	L	B	B	5	1	0	6	K	T	N	A	0	1
①	②	③	④	⑤	⑥	⑦	⑧	⑨	⑩										

## ①Series

Code (1)(2)(3)(4)	
MSAS	Multilayer Ceramic Capacitor (High dielectric type) for General Electronic Equipment for Consumer Multilayer Ceramic Capacitor (Temperature compensating type) for General Electronic Equipment for Consumer Medium-High Voltage Multilayer Ceramic Capacitor for General Electronic Equipment for Consumer
MSAR	High frequency/Low loss Multilayer Ceramic Capacitor for General Electronic Equipment for Consumer
MSAY	Low distortion design/Audible/Good bias Multilayer Ceramic Capacitor for General Electronic Equipment for Consumer
MSRL	LW Reversal Decoupling Low ESL Capacitor (LWDC™) for General Electronic Equipment for Consumer

## (1) Product Group

Code	
M	Multilayer Ceramic Capacitor

## (2) Category

Code	Recommended equipment	Quality Grade
S	General Electronic Equipment for Consumer	3

## (3) Type

Code	
A	2 terminals
R	LW reversal

## (4) Features, Characteristics

Code	
S	Standard/General
R	High frequency/Low loss
Y	Low distortion design/Audible/Good bias
L	Low ESL

## ②Rated voltage

Code	Rated voltage [VDC]
P	2.5
A	4
J	6.3
L	10
E	16
T	25
G	35
U	50
H	100
Q	250
S	630
X	2000

## ④Thickness

Code	Thickness [mm]
1	0.125
H	0.13 (1.5 max ※)
E	0.18 (1.1 max ※)
2	0.2
3	0.3
K	0.45
5	0.5
8	0.8
9	0.85
Q	1.15
G	1.25
L	1.6
N	1.9 (0.088 ※)
Y	2.0 max
M	2.5

Note : ※LW reverse type (MSRL)

## ③Dimension

Code	(L × W) [mm]	JIS(mm)	EIA(inch)
02	0.25 × 0.125	0201	008004
04	0.4 × 0.2	0402	01005
06	0.6 × 0.3	0603	0201
1L	1.0 × 0.5	1005	0402
10	1.0 × 0.5	1005	0402
	0.52 × 1.0 ※	0510	0204
16	1.6 × 0.8	1608	0603
	0.8 × 1.6 ※	0816	0306
21	2.0 × 1.25	2012	0805
	1.25 × 2.0 ※	1220	0508
31	3.2 × 1.6	3216	1206
32	3.2 × 2.5	3225	1210
45	4.5 × 3.2	4532	1812

Note : ※LW reverse type (MSRL)

## ⑤Dimension tolerance

Code	Dimension code	L[mm]	W[mm]	T[mm]	Thickness code			
A	06	0.6±0.05	0.3±0.05	0.3±0.05	3			
	10	1.0±0.10	0.5±0.10	0.5±0.10	5			
	16	1.6+0.15/-0.05	0.8+0.15/-0.05	0.8+0.15/-0.05	8			
	21	2.0+0.15/-0.05	1.25+0.15/-0.05	1.25+0.15/-0.05	G			
	31	3.2±0.20	1.6±0.20	1.6±0.20	L			
	32	3.2±0.30	2.5±0.30	2.5±0.30	M			
	45	4.5±0.40	3.2±0.30	2.0+0/-0.30	Y			
B	06	0.6±0.09	0.3±0.09	0.3±0.09	3			
	10	1.0+0.15/-0.05	0.5+0.15/-0.05	0.5+0.15/-0.05	5			
	16	1.6+0.20/-0	0.8+0.20/-0	0.8+0.20/-0	8			
	21	2.0+0.20/-0	1.25+0.20/-0	1.25+0.20/-0	G			
	31	3.2±0.30	1.6±0.30	1.6±0.30	L			
	32	3.2±0.30	2.5±0.20	1.9+0.1/-0.20	Y			
C	10	1.0+0.20/-0	0.5+0.20/-0	0.5+0.20/-0	5			
E	06	0.6+0.25/-0	0.3+0.25/-0	0.3+0.25/-0	3			
	10	1.0+0.30/-0	0.5+0.30/-0	0.5+0.30/-0	5			
H	31	3.2±0.15	1.6±0.15	0.85±0.10	9			
				1.15±0.10	Q			
J	16	1.6+0.20/-0	0.8+0.20/-0	0.45±0.05	K			
	21	2.0+0.15/-0.05	1.25+0.15/-0.05	0.85±0.10	9			
	32	3.2±0.30	2.5±0.20	0.85±0.10	9			
				1.15±0.10	Q			
L	21	2.0+0.20/-0	1.25+0.20/-0	0.85±0.10	9			
	31	3.2±0.20	1.6±0.20	0.85±0.10	9			
S	02	0.25±0.013	0.125±0.013	0.125±0.013	1			
					2			
					3			
	10	1.0±0.05	0.5±0.05	0.5±0.05	5			
					0.52±0.05 ※	1.0±0.05	0.3±0.05	3
	16	1.6±0.10	0.8±0.10	0.8±0.10	8			
					0.8±0.10 ※	1.6±0.10	0.5±0.05	5
	21	2.0±0.10	1.25±0.10	1.25±0.10	0.85±0.10	9		
					1.25±0.10	G		
					1.25±0.15 ※	2.0±0.15	0.85±0.10	9
					3.2±0.15	1.6±0.15	1.6±0.20	L
	32	3.2±0.30	2.5±0.20	2.5±0.20	M			
					1.9±0.20	N		
					2.5±0.20	M		
45	4.5±0.40	3.2±0.30	3.2±0.30	2.5±0.20	M			
T	16	1.6±0.10	0.8±0.10	0.45±0.05	K			
X	1L	1.0±0.05	0.5±0.05	0.13±0.02	H			
				0.18±0.02	E			
				0.2±0.02	2			
Y	1L	1.0±0.05	0.5±0.05	0.3±0.03	3			

Note :※LW reverse type (MSRL)

## ⑥ Temperature characteristics code

■ High dielectric type (SD: Excluding Low distortion design/Audible/Good bias Multilayer Ceramic Capacitor)

Code	Applicable standard		Temperature range [°C]	Ref. Temp. [°C]	Capacitance change	Capacitance tolerance	Tolerance code
B5	JIS	B	-25 ~ + 85	20	±10%	±10%	K
						±20%	M
	EIA	X5R	-55 ~ + 85	25	±15%	±10%	K
						±20%	M
B7	EIA	X7R	-55 ~ +125	25	±15%	±10%	K
						±20%	M
C6	EIA	X6S	-55 ~ +105	25	±22%	±10%	K
						±20%	M
C7	EIA	X7S	-55 ~ +125	25	±22%	±10%	K
						±20%	M
LD(※)	EIA	X5R	-55 ~ + 85	25	±15%	±10%	K
						±20%	M

Note : ※.LD: Low distortion design/Audible/Good bias Multilayer Ceramic Capacitor

## ■ Temperature compensating type

Code	Applicable standard		Temperature range [°C]	Ref. Temp. [°C]	Capacitance change	Capacitance tolerance	Tolerance code
CG	JIS	CG	-55 ~ +125	20	0 ± 30ppm/°C	±0.05pF	A
						±0.1pF	B
	±0.25pF	C					
	EIA	C0G		25		±0.5pF	D
						±2%	G
					±5%	J	
CH	JIS	CH	-55 ~ +125	20	0 ± 60ppm/°C	±0.05pF	A
						±0.1pF	B
	±0.25pF	C					
	EIA	C0H		25		±0.5pF	D
						±2%	G
					±5%	J	
CJ	JIS	CJ	-55 ~ +125	20	0 ± 120ppm/°C	±0.05pF	A
	EIA	C0J		25		±0.1pF	B
						±0.25pF	C
CK	JIS	CK	-55 ~ +125	20	0 ± 250ppm/°C	±0.05pF	A
	EIA	C0K		25		±0.1pF	B
						±0.25pF	C

## ⑥ Series code

• Low distortion design/Audible/Good bias Multilayer Ceramic Capacitor

Code	Series code
SD	Standard

• Medium-High Voltage Multilayer Ceramic Capacitor

Code	Series code
SD	Standard

## ⑦ Nominal capacitance

Code (example)	Nominal capacitance
0R5	0.5pF
010	1pF
100	10pF
101	100pF
102	1,000pF
103	0.01μF
104	0.1μF
105	1μF
106	10μF
107	100μF

Note : R=Decimal point

## ⑧ Capacitance tolerance

Code	Capacitance tolerance
A	±0.05pF
B	±0.1pF
C	±0.25pF
D	±0.5pF
G	±2%
J	±5%
K	±10%
M	±20%

## ⑨ Packaging

Code	Packaging
F	φ178mm Taping (2mm pitch)
T	φ178mm Taping (4mm pitch)
P	φ178mm Taping (4mm pitch, 1000 pcs/reel) 3225 type (Thickness code M)
R	φ178mm Embossed Taping 1005type (2mm pitch) 1608type (4mm pitch)
W	φ178mm Embossed Taping (1mm pitch) 0201/0402type

## ⑩ Internal code

## STANDARD EXTERNAL DIMENSIONS

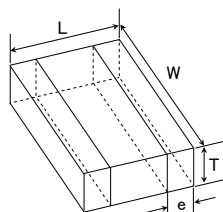
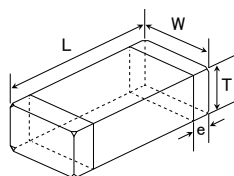

※LW reverse type

Type	JIS (mm)	EIA (inch)	Dimension [mm]				
			L	W	T	*1	e
MSAS□02	0201	008004	0.25±0.013	0.125±0.013	0.125±0.013	1	0.0675±0.0275
MSAR□02	0201	008004	0.25±0.013	0.125±0.013	0.125±0.013	1	0.0675±0.0275
MSAS□04	0402	01005	0.4±0.02	0.2±0.02	0.2±0.02	2	0.1±0.03
MSAR□04	0402	01005	0.4±0.02	0.2±0.02	0.2±0.02	2	0.1±0.03
MSAS□06	0603	0201	0.6±0.03	0.3±0.03	0.3±0.03	3	0.15±0.05
MSAS□1L	1005	0402	1.0±0.05	0.5±0.05	0.13±0.02	H	0.25±0.10
					0.18±0.02	E	
					0.2±0.02	2	
					0.3±0.03	3	
MSAS□10	1005	0402	1.0±0.05	0.5±0.05	0.5±0.05	5	0.25±0.10
MSAY□1L	1005	0402	1.0±0.05	0.5±0.05	0.3±0.03	3	0.25±0.10
MSAY□10	1005	0402	1.0±0.05	0.5±0.05	0.5±0.05	5	0.25±0.10
MSRL□10 ※	0510	0204	0.52±0.05	1.0±0.05	0.3±0.05	3	0.18±0.08
MSAS□16	1608	0603	1.6±0.10	0.8±0.10	0.45±0.05	K	0.35±0.25
					0.8±0.10	8	
MSAY□16	1608	0603	1.6±0.10	0.8±0.10	0.8±0.10	8	0.35±0.25
MSRL□16 ※	0816	0306	0.8±0.10	1.6±0.10	0.5±0.05	5	0.25±0.15
MSAS□21	2012	0805	2.0±0.10	1.25±0.10	0.85±0.10	9	0.5±0.25
					1.25±0.10	G	
MSRL□21 ※	1220	0508	1.25±0.15	2.0±0.15	0.85±0.10	9	0.3±0.2
MSAS□31	3216	1206	3.2±0.15	1.6±0.15	0.85±0.10	9	0.5+0.35/-0.25
					1.15±0.10	Q	
					1.6±0.20	L	
MSAY□31	3216	1206	3.2±0.15	1.6±0.15	1.15±0.10	Q	0.5+0.35/-0.25
					1.6±0.20	L	
MSAS□32	3225	1210	3.2±0.30	2.5±0.20	0.85±0.10	9	0.6±0.3
					1.15±0.10	Q	
					1.9±0.20	N	
					1.9+0.1/-0.20	Y	
MSAY□32	3225	1210	3.2±0.30	2.5±0.20	2.5±0.20	M	0.6±0.3
					1.9±0.20	N	
MSAS□45	4532	1812	4.5±0.40	3.2±0.30	2.0+0/-0.30	Y	0.6±0.4
					2.5±0.20	M	

Note :※LW reverse type (MSRL), \*1.Thickness code

## ■ STANDARD QUANTITY

Type			Thickness		Standard quantity [pcs]	
Code	JIS(mm)	EIA(inch)	[mm]	Code	Paper tape	Embossed tape
02	0201	008004	0.125	1	—	50000
04	0402	01005	0.2	2	—	40000
06	0603	0201	0.3	3	15000	—
1L	1005	0402	0.13	H	—	20000
			0.18	E	—	15000
			0.2	2	20000	—
			0.3	3	15000	—
10	1005	0402	0.5	5	10000	—
	0510 ※	0204 ※	0.3	3		
16	1608	0603	0.45	K	4000	—
			0.8	8		
	0816 ※	0306 ※	0.5	5	—	4000
21	2012	0805	0.85	9	4000	—
			1.25	G	—	3000
	1220 ※	0508 ※	0.85	9	4000	—
31	3216	1206	0.85	9	4000	—
			1.15	Q	—	3000
			1.6	L	—	2000
32	3225	1210	0.85	9	—	2000
			1.15	Q		
			1.9	N		
			2.0 max	Y		
			2.5	M		
45	4532	1812	2.0 max	Y	—	1000
			2.5	M	—	500

Note : ※:LW Reverse type (MSRL)

## PART NUMBER

## LW Reversal Decoupling Low ESL Capacitors (LWDC™) for General Electronic Equipment for Consumer

## 0510TYPE

【Temperature Characteristic B5(BJ) : X5R(-55~+85°C)】 0.3mm thickness

New part number	Old part number (for reference)	Rated voltage [V]	Temperature characteristics	Capacitance [F]	Capacitance tolerance [%]	tan δ [%]	HTLT		Note
							Rated voltage x %	Thickness <sup>*3</sup> [mm]	
MSRLT103SB5104MFNA01	TWK105 BJ104MP-F	25	X5R	0.1 μ	±20	5	150	0.3±0.05	
MSRLE103SB5224MFNA01	EWK105 BJ224MP-F	16	X5R	0.22 μ	±20	10	150	0.3±0.05	
MSRLL103SB5474MFNA01	LWK105 BJ474MP-F	10	X5R	0.47 μ	±20	10	150	0.3±0.05	
MSRLJ103SB5104MFNA01	JWK105 BJ104MP-F	6.3	X5R <sup>*1</sup>	0.1 μ	±20	5	150	0.3±0.05	
MSRLJ103SB5474MFNA01	JWK105 BJ474MP-F		X5R <sup>*1</sup>	0.47 μ	±20	10	150	0.3±0.05	
MSRLJ103SB5105MFNA01	JWK105 BJ105MP-F		X5R	1 μ	±20	10	150	0.3±0.05	
MSRLJ103SB5225MFNA01	JWK105 BJ225MP-F		X5R	2.2 μ	±20	10	150	0.3±0.05	

【Temperature Characteristic C6 : X6S(-55~+105°C), C7 : X7S(-55~+125°C)】 0.3mm thickness

New part number	Old part number (for reference)	Rated voltage [V]	Temperature characteristics	Capacitance [F]	Capacitance tolerance [%]	tan δ [%]	HTLT		Note
							Rated voltage x %	Thickness <sup>*3</sup> [mm]	
MSRLE103SC6104MFNA01	EWK105 C6104MP-F	16	X6S	0.1 μ	±20	5	150	0.3±0.05	
MSRLL103SC7104MFNA01	LWK105 C7104MP-F	10	X7S	0.1 μ	±20	5	150	0.3±0.05	
MSRLL103SC6224MFNA01	LWK105 C6224MP-F		X6S	0.22 μ	±20	10	150	0.3±0.05	
MSRLJ103SC7104MFNA01	JWK105 C7104MP-F	6.3	X7S	0.1 μ	±20	5	150	0.3±0.05	
MSRLJ103SC7224MFNA01	JWK105 C7224MP-F		X7S	0.22 μ	±20	10	150	0.3±0.05	
MSRLJ103SC6474MFNA01	JWK105 C6474MP-F		X6S	0.47 μ	±20	10	150	0.3±0.05	
MSRLA103SC6224MFNA01	AWK105 C6224MP-F		X6S	0.22 μ	±20	10	150	0.3±0.05	
MSRLA103SC6474MFNA01	AWK105 C6474MP-F		X6S	0.47 μ	±20	10	150	0.3±0.05	
MSRLA103SC6105MFNA01	AWK105 C6105MP-F	4	X6S	1 μ	±20	10	150	0.3±0.05	
MSRLA103SC6225MFNA01	AWK105 C6225MP-F		X6S	2.2 μ	±20	10	150	0.3±0.05	

## 0816TYPE

【Temperature Characteristic B5(BJ) : X5R(-55~+85°C)】 0.5mm thickness

New part number	Old part number (for reference)	Rated voltage [V]	Temperature characteristics	Capacitance [F]	Capacitance tolerance [%]	tan δ [%]	HTLT		Note
							Rated voltage x %	Thickness <sup>*3</sup> [mm]	
MSRLT165SB5104MTNA01	TWK107 BJ104MV-T	25	X5R <sup>*1</sup>	0.1 μ	±20	5	150	0.5±0.05	
MSRLE165SB5224MTNA01	EWK107 BJ224MV-T	16	X5R <sup>*1</sup>	0.22 μ	±20	5	150	0.5±0.05	
MSRLE165SB5474MTNA01	EWK107 BJ474MV-T		X5R <sup>*1</sup>	0.47 μ	±20	5	150	0.5±0.05	
MSRLL165SB5105MTNA01	LWK107 BJ105MV-T	10	X5R	1 μ	±20	10	150	0.5±0.05	
MSRLL165SB5225MTNA01	LWK107 BJ225MV-T		X5R	2.2 μ	±20	10	150	0.5±0.05	
MSRLJ165SB5105MTNA01	JWK107 BJ105MV-T		X5R <sup>*1</sup>	1 μ	±20	10	150	0.5±0.05	
MSRLJ165SB5225MTNA01	JWK107 BJ225MV-T		X5R	2.2 μ	±20	10	150	0.5±0.05	
MSRLJ165SB5475MTNA01	JWK107 BJ475MV-T		X5R	4.7 μ	±20	10	150	0.5±0.05	
MSRLA165SB5106MTNA01	AWK107 BJ106MV-T	4	X5R	10 μ	±20	10	150	0.5±0.05	

【Temperature Characteristic B7 : X7R(-55~+125°C), C6 : X6S(-55~+105°C), C7 : X7S(-55~+125°C)】 0.5mm thickness

New part number	Old part number (for reference)	Rated voltage [V]	Temperature characteristics	Capacitance [F]	Capacitance tolerance [%]	tan δ [%]	HTLT		Note
							Rated voltage x %	Thickness <sup>*3</sup> [mm]	
MSRLT165SB7104MTNA01	TWK107 B7104MV-T	25	X7R	0.1 μ	±20	5	150	0.5±0.05	
MSRLE165SB7224MTNA01	EWK107 B7224MV-T	16	X7R	0.22 μ	±20	5	150	0.5±0.05	
MSRLE165SB7474MTNA01	EWK107 B7474MV-T		X7R	0.47 μ	±20	5	150	0.5±0.05	
MSRLJ165SC7105MTNA01	JWK107 C7105MV-T	6.3	X7S	1 μ	±20	10	150	0.5±0.05	
MSRLA165SC7225MTNA01	AWK107 C7225MV-T		X7S	2.2 μ	±20	10	150	0.5±0.05	
MSRLA165SC6475MTNA01	AWK107 C6475MV-T	4	X6S	4.7 μ	±20	10	150	0.5±0.05	
MSRLP165SC6106MTNA01	PWK107 C6106MV-T		X6S	10 μ	±20	10	150	0.5±0.05	

## 1220TYPE

【Temperature Characteristic B5(BJ) : X5R(-55~+85°C)】 0.85mm thickness

New part number	Old part number (for reference)	Rated voltage [V]	Temperature characteristics	Capacitance [F]	Capacitance tolerance [%]	tan δ [%]	HTLT		Note
							Rated voltage x %	Thickness <sup>*3</sup> [mm]	
MSRLT219SB5475□TNA01	TWK212 BJ475□D-T	25	X5R	4.7 μ	±10, ±20	10	150	0.85±0.10	
MSRLE219SB5106MTNA01	EWK212 BJ106MD-T	16	X5R	10 μ	±20	10	150	0.85±0.10	
MSRLL219SB5475□TNA01	LWK212 BJ475□D-T	10	X5R	4.7 μ	±10, ±20	10	150	0.85±0.10	
MSRLL219SB5106MTNA01	LWK212 BJ106MD-T		X5R	10 μ	±20	10	150	0.85±0.10	
MSRLJ219SB5226MTNA01	JWK212 BJ226MD-T	6.3	X5R	22 μ	±20	10	150	0.85±0.10	

【Temperature Characteristic B7 : X7R(-55~+125°C), C6 : X6S(-55~+105°C)】 0.85mm thickness

New part number	Old part number (for reference)	Rated voltage [V]	Temperature characteristics	Capacitance [F]	Capacitance tolerance [%]	tan δ [%]	HTLT		Note
							Rated voltage x %	Thickness <sup>*3</sup> [mm]	
MSRLT219SB7225□TNA01	TWK212 B7225□D-T	25	X7R	2.2 μ	±10, ±20	5	150	0.85±0.10	
MSRLE219SC6475□TNA01	EWK212 C6475□D-T	16	X6S	4.7 μ	±10, ±20	10	150	0.85±0.10	
MSRLL219SC6106MTNA01	LWK212 C6106MD-T	10	X6S	10 μ	±20	10	150	0.85±0.10	
MSRLA219SC6226MTNA01	AWK212 C6226MD-T	4	X6S	22 μ	±20	10	150	0.85±0.10	

\* This catalog contains the typical specification only due to the limitation of space. When you consider the purchase of our products, please check our specification.  
For details of each product (characteristics graph, reliability information, precautions for use, and so on), see our Web site (<http://www.ty-top.com/>).

# Multilayer Ceramic Capacitors

## PACKAGING

### ① Minimum Quantity

#### ● Taped package

Type			Thickness		Standard Quantity [pcs]	
Code	JIS(mm)	EIA(inch)	[mm]	Code	Paper tape	Embossed tape
02	0201	008004	0.125	1	—	50000
04	0402	01005	0.2	2	—	40000
06	0603	0201	0.3	3	15000	—
1L	1005	0402	0.13	H	—	20000
			0.18	E	—	15000
			0.2	2	20000	—
			0.3	3	15000	—
10	1005	0402	0.5	5	10000	—
	0510 ※	0204	0.3	3	10000	—
16	1608	0603	0.45	K	4000	—
			0.7	7		
			0.8	8		
			0.8	8	3000 (Soft Termination)	3000 (Soft Termination)
	0816 ※	0306	0.5	5	—	4000
21	2012	0805	0.85	9	4000	—
			1.25	G	—	3000
			1.25	G	—	2000 (Soft Termination)
	1220 ※	0508	0.85	9	4000	—
31	3216	1206	0.85	9	4000	—
			1.15	Q	—	3000
			1.6	L	—	2000
32	3225	1210	0.85	9	—	2000
			1.15	Q		
			1.9	N		
			2.0 max	Y		
			2.5	M	—	500(T), 1000(P)
45	4532	1812	2.0 max	Y	—	1000
			2.5	M	—	500

注: ※LW Reverse type (MSRL, MCRL, MBRL, MLRL, MMRL)

## ② Taping material

※ No bottom tape for pressed carrier tape

- Card board carrier tape
- Embossed tape

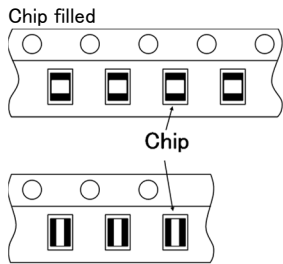
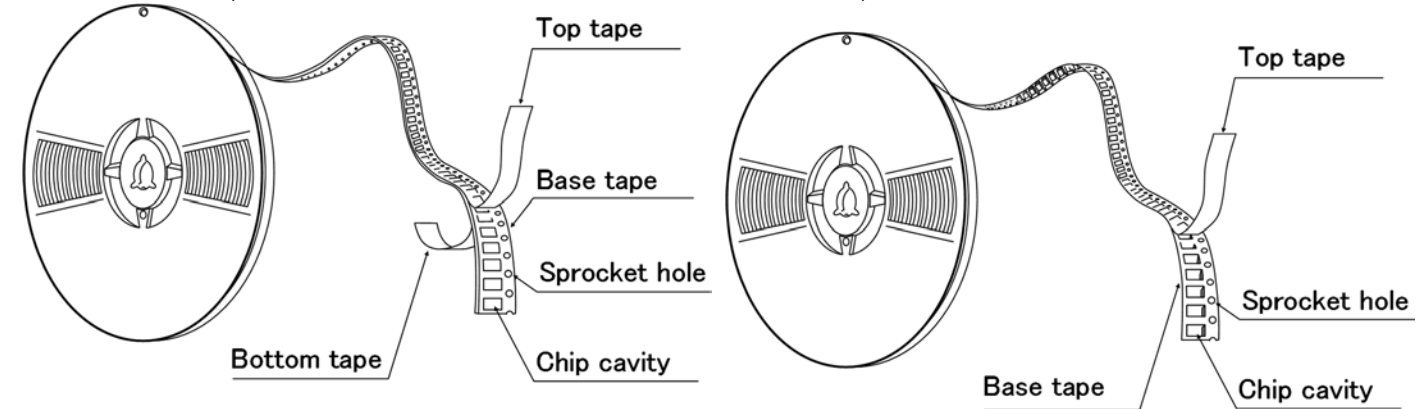

※ LW Reverse type.

## ③ Representative taping dimensions

● Paper Tape (8mm wide)

● Pressed carrier tape ( 2mm pitch)

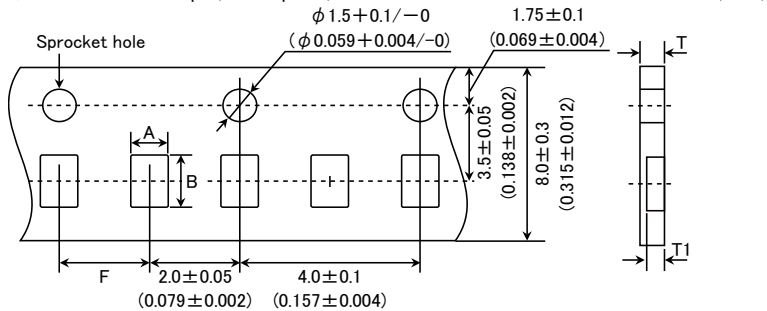

Type(EIA)	Chip Cavity		Insertion Pitch F	Tape Thickness	
	A	B		T	T1
0603 (0201)	0.37	0.67	2.0 ± 0.05	0.45max.	0.42max.
0510 (0204) ※	0.65	1.15		0.4max.	0.3max.
1005 (0402) (*1 2)				0.45max.	0.42max.
1005 (0402) (*1 3)					

Note \*1 Thickness, 2:0.2mm, 3:0.3mm. ※ LW Reverse type.

Unit: mm

● Punched carrier tape (2mm pitch)

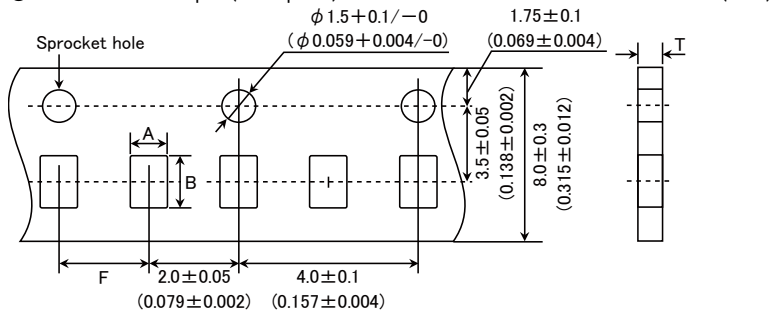

Type(EIA)	Chip Cavity		Insertion Pitch F	Tape Thickness
	A	B		T
1005 (0402)	0.65	1.15	2.0 ± 0.05	0.8max.

Unit: mm

▶ This catalog contains the typical specification only due to the limitation of space. When you consider the purchase of our products, please check our specification. For details of each product (characteristics graph, reliability information, precautions for use, and so on), see our Web site (<http://www.ty-top.com/>).

● Punched carrier tape (4mm pitch)

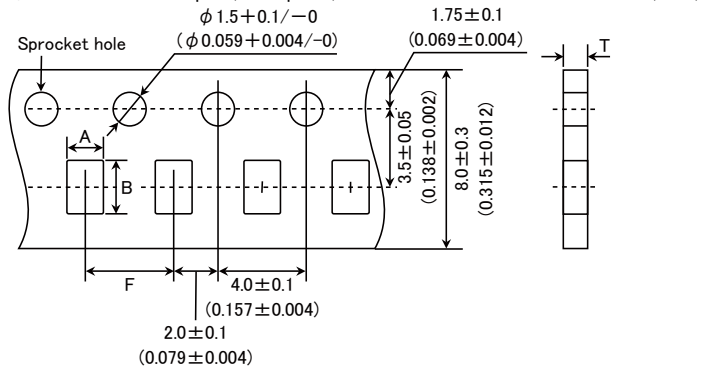

Type(EIA)	Chip Cavity		Insertion Pitch F	Tape Thickness	
	A	B		K	T
1608 (0603)	1.0	1.8	4.0 ± 0.1	1.1max.	1.1max.
0816 (0306) ※					
2012 (0805)					
1220 (0508) ※	1.65	2.4	4.0 ± 0.1	1.1max.	1.1max.
3216 (1206)	2.0	3.6			

Note: Taping size might be different depending on the size of the product. ※ LW Reverse type.

Unit: mm

● Embossed tape (4mm wide)

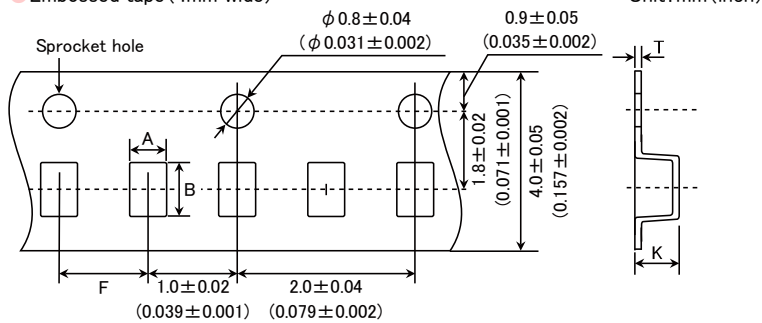

Type(EIA)	Chip Cavity		Insertion Pitch F	Tape Thickness	
	A	B		K	T
0201 (008004)	0.135	0.27	1.0 ± 0.02	0.5max.	0.25max.
0402 (01005)	0.23	0.43			

Unit: mm

● Embossed tape (8mm wide)

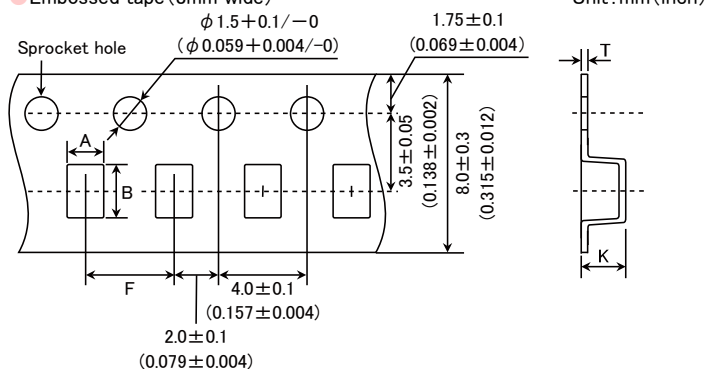

Type(EIA)	Chip Cavity		Insertion Pitch F	Tape Thickness	
	A	B		K	T
1005 (0402)	0.6	1.1	2.0 ± 0.1	0.6max	0.2 ± 0.1
0816 (0306) ※	1.0	1.8	4.0 ± 0.1	1.3max.	0.25 ± 0.1
2012 (0805)	1.65	2.4			
3216 (1206)	2.0	3.6		3.4max.	0.6max.
3225 (1210)	2.8	3.6			

Note: ※ LW Reverse type.

Unit: mm

► This catalog contains the typical specification only due to the limitation of space. When you consider the purchase of our products, please check our specification. For details of each product (characteristics graph, reliability information, precautions for use, and so on), see our Web site (<http://www.ty-top.com/>).

● Embossed tape (12mm wide) Unit: mm (inch)

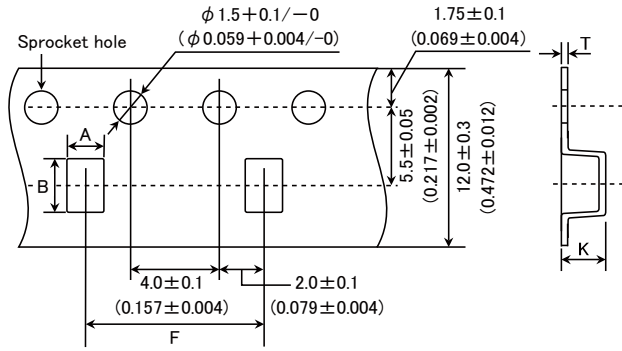

Type(EIA)	Chip Cavity		Insertion Pitch	Tape Thickness	
	A	B		K	T
3225 (1210)	3.1	4.0	8.0 ± 0.1	4.0max.	0.6max.
4532 (1812)	3.7	4.9	8.0 ± 0.1	4.0max.	0.6max.

Unit: mm

④ Trailer and Leader

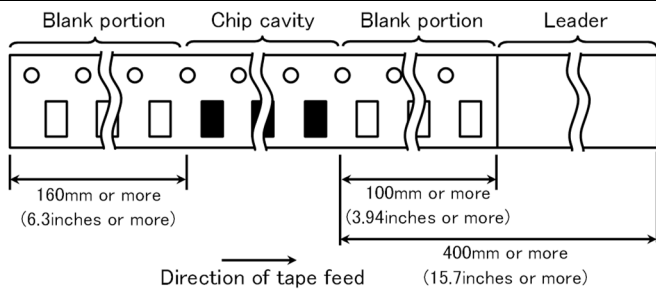

⑤ Reel size

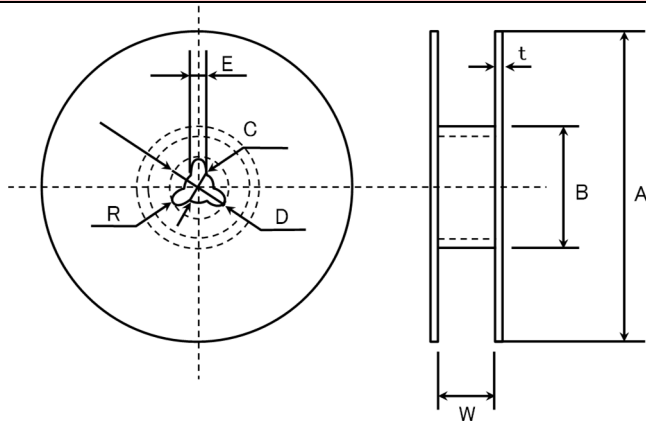

A	B	C	D	E	R
$\phi 178 \pm 2.0$	$\phi 50 \text{min.}$	$\phi 13.0 \pm 0.2$	$\phi 21.0 \pm 0.8$	$2.0 \pm 0.5$	1.0

	T	W
4mm wide tape	1.5max.	$5 \pm 1.0$
8mm wide tape	2.5max.	$10 \pm 1.5$
12mm wide tape	2.5max.	$14 \pm 1.5$

Unit: mm

⑥ Top Tape Strength

The top tape requires a peel-off force of 0.1 to 0.7N in the direction of the arrow as illustrated below.

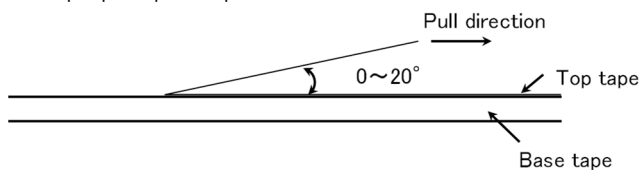

▶ This catalog contains the typical specification only due to the limitation of space. When you consider the purchase of our products, please check our specification. For details of each product (characteristics graph, reliability information, precautions for use, and so on), see our Web site (<http://www.ty-top.com/>).

**Multilayer Ceramic Capacitors for General Electronic Equipment for Consumer**  
**Multilayer Ceramic Capacitors**  
**for Medical Devices classified as GHTF Classes A or B (Japan Classes I or II)**

■ RELIABILITY DATA

1. Operating Temperature Range

Specified Value	Temperature Compensating (Class1)	Standard	-55 to +125°C	
		High Frequency Type		
Specified Value	High Permittivity (Class2)		Specification	Temperature Range
		B5	B	-25 to +85°C
			X5R	-55 to +85°C
		B7	X7R	-55 to +125°C
		C6	X6S	-55 to +105°C
C7	X7S	-55 to +125°C		

2. Storage Conditions

Specified Value	Temperature Compensating (Class1)	Standard	-55 to +125°C	
		High Frequency Type		
Specified Value	High Permittivity (Class2)		Specification	Temperature Range
		B5	B	-25 to +85°C
			X5R	-55 to +85°C
		B7	X7R	-55 to +125°C
		C6	X6S	-55 to +105°C
C7	X7S	-55 to +125°C		

3. Rated Voltage

Specified Value	Temperature Compensating (Class1)	Standard	50VDC, 25VDC, 16VDC
		High Frequency Type	25VDC, 16VDC
	High Permittivity (Class2)		50VDC, 35VDC, 25VDC, 16VDC, 10VDC, 6.3VDC, 4VDC, 2.5VDC

4. Withstanding Voltage (Between terminals)

Specified Value	Temperature Compensating (Class1)	Standard	No breakdown or damage
		High Frequency Type	
Test Methods and Remarks	High Permittivity (Class2)		
		Class 1	Class 2
	Applied voltage	Rated voltage × 3	Rated voltage × 2.5
	Duration	1 to 5 sec.	
	Charge/discharge current	50mA max.	

5. Insulation Resistance

Specified Value	Temperature Compensating (Class1)	Standard	10000 MΩ min.
		High Frequency Type	
	High Permittivity (Class2)	Note 1	$C \leq 0.047 \mu F$ : 10000 MΩ min. $C > 0.047 \mu F$ : $500 M\Omega \cdot \mu F$ (C: Nominal capacitance)
Test Methods and Remarks	Applied voltage	: Rated voltage	
	Duration	: 60±5 sec.	
	Charge/discharge current	: 50mA max.	

► This catalog contains the typical specification only due to the limitation of space. When you consider the purchase of our products, please check our specification. For details of each product (characteristics graph, reliability information, precautions for use, and so on), see our Web site (<http://www.ty-top.com/>).

**6. Capacitance (Tolerance)**

Specified Value	Temperature Compensating (Class1)	Standard	$0.2\text{pF} \leq C \leq 5\text{pF} : \pm 0.25\text{pF}$ $5\text{pF} \leq C \leq 10\text{pF} : \pm 0.5\text{pF}$ $C > 10\text{pF} : \pm 5\%$	
		High Frequency Type	Refer to detailed specification	
	High Permittivity (Class2)		$\pm 10\%$ or $\pm 20\%$	
Test Methods and Remarks		Class 1		Class 2
		Standard	High Frequency Type	$C \leq 10 \mu\text{F}$ $C > 10 \mu\text{F}$
	Preconditioning	None		Thermal treatment (at 150°C for 1hr) Note 2
	Measuring frequency	1MHz ± 10%	1GHz	$1\text{kHz} \pm 10\%$ $120 \pm 10\text{Hz}$
	Measuring voltage Note 1	0.5 to 5Vrms		$1 \pm 0.2\text{Vrms}$ $0.5 \pm 0.1\text{Vrms}$
	Bias application	None		

**7. Q or Dissipation Factor**

Specified Value	Temperature Compensating (Class1)	Standard	$C < 30\text{pF} : Q \geq 400 + 20C$ $C \geq 30\text{pF} : Q \geq 1000$ (C: Nominal capacitance)	
		High Frequency Type	Refer to detailed specification	
	High Permittivity (Class2) Note 1		2.5% max.	
Test Methods and Remarks		Class 1		Class 2
		Standard	High Frequency Type	$C \leq 10 \mu\text{F}$ $C > 10 \mu\text{F}$
	Preconditioning	None		Thermal treatment (at 150°C for 1hr) Note 2
	Measuring frequency	1MHz ± 10%	1GHz	$1\text{kHz} \pm 10\%$ $120 \pm 10\text{Hz}$
	Measuring voltage Note 1	0.5 to 5Vrms		$1 \pm 0.2\text{Vrms}$ $0.5 \pm 0.1\text{Vrms}$
	Bias application	None		

**8. Temperature Characteristic (Without voltage application)**

Specified Value	Temperature Compensating (Class1)	Standard	Temperature Characteristic [ppm/°C]		Tolerance [ppm/°C]		
			$C \square : 0$	CG(C0G) CH(C0H) CJ(C0J) CK(C0K)	G: ±30 H: ±60 J: ±120 H: ±250		
		High Frequency Type	Temperature Characteristic [ppm/°C]		Tolerance [ppm/°C]		
			$C \square : 0$	CG(C0G) CH(C0H)	G: ±30 H: ±60		
	High Permittivity (Class2)		Specification	Capacitance change	Reference temperature	Temperature Range	
			B5	B X5R	±10% ±15%	20°C 25°C	-25 to +85°C -55 to +85°C
			B7	X7R	±15%	25°C	-55 to +125°C
			C6	XS	±22%	25°C	-55 to +105°C
			C7	X7S	±22%	25°C	-55 to +125°C

Test Methods and Remarks	Class 1 Capacitance at 20°C and 85°C shall be measured in thermal equilibrium, and the temperature characteristic shall be calculated from the following equation.																
	$\frac{(C_{85} - C_{20})}{C_{20} \times \Delta T} \times 10^6 (\text{ppm}/^\circ\text{C}) \quad \Delta T = 65$																
	Class 2 Capacitance at each step shall be measured in thermal equilibrium, and the temperature characteristic shall be calculated from the following equation.																
	<table border="1"> <tr> <th>Step</th> <th>B</th> <th>X5R, X7R, X6S, X7S</th> </tr> <tr> <td>1</td> <td colspan="2">Minimum operating temperature</td> </tr> <tr> <td>2</td> <td>20°C</td> <td>25°C</td> </tr> <tr> <td>3</td> <td colspan="2">Maximum operating temperature</td> </tr> </table>					Step	B	X5R, X7R, X6S, X7S	1	Minimum operating temperature		2	20°C	25°C	3	Maximum operating temperature	
	Step	B	X5R, X7R, X6S, X7S														
1	Minimum operating temperature																
2	20°C	25°C															
3	Maximum operating temperature																
$\frac{(C - C_2)}{C_2} \times 100 (\%) \quad C : \text{Capacitance in Step 1 or Step 3}$ $C_2 : \text{Capacitance in Step 2}$																	
※Measuring frequency and voltage: Refer to detailed specification																	

► This catalog contains the typical specification only due to the limitation of space. When you consider the purchase of our products, please check our specification. For details of each product (characteristics graph, reliability information, precautions for use, and so on), see our Web site (<http://www.ty-top.com/>).

## 9. Deflection

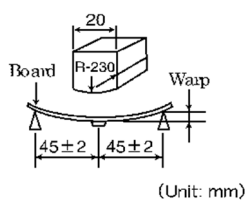
Specified Value	Temperature Compensating (Class1)	Standard	Appearance : No abnormality Capacitance change : Within $\pm 5\%$ or $\pm 0.5$ pF, whichever is larger.	
		High Frequency Type	Appearance : No abnormality Capacitance change : Within $\pm 0.5$ pF	
	High Permittivity (Class2)		Appearance : No abnormality Capacitance change : Within $\pm 12.5\%$	
Test Methods and Remarks	Multilayer Ceramic Capacitors		 <p style="font-size: small;">(Unit: mm) Capacitance measurement shall be conducted with the board bent</p>	
		0201, 0402, 0603, ※1005 Type		The other types
	Board	Glass epoxy-resin substrate		
	Thickness	0.8mm		1.6mm
	Warp	1mm		
	Duration	10 sec.		
	※1005 Type thickness, 2: 0.2mm, 3: 0.3mm.			

## 10. Adhesive Strength of Terminal Electrodes

Specified Value	Temperature Compensating (Class1)	Standard	No terminal separation or its indication.	
		High Frequency Type		
	High Permittivity (Class2)			
Test Methods and Remarks		0201Type	0402, 0603Type	1005Type or more
	Applied force	1N	2N	5N
	Duration	10 ± 1 sec		30 ± 5 sec

## 11. Vibration

Specified Value	Temperature Compensating (Class1)	Standard	Initial performance shall be satisfied.
		High Frequency Type	
	High Permittivity (Class2)		
Test Methods and Remarks	Preconditioning	: Thermal treatment (at 150°C for 1hr) Note2 (Only High permittivity)	
	Frequency range	: 10 to 55 Hz	
	Overall amplitude	: 1.5 mm	
	Sweeping method	: 10 to 55 to 10 Hz for 1 min Two hours each in X, Y, Z directions: 6 hrs in total	

## 12. Solderability

Specified Value	Temperature Compensating (Class1)	Standard	At least 95% of terminal electrode is covered by new solder.
		High Frequency Type	
	High Permittivity (Class2)		
Test Methods and Remarks		Eutectic solder	Lead-free solder
	Solder type	H60A or H63A	Sn-3.0Ag-0.5Cu
	Solder temperature	230 ± 5°C	
	Duration	4 ± 1 sec.	

### 13. Resistance to Soldering

Specified Value	Temperature Compensating (Class1)	Standard	Appearance : No abnormality Capacitance change : Within $\pm 2.5\%$ or $\pm 0.25\text{pF}$ , whichever is larger. Q : Initial value Insulation resistance : Initial value Withstanding voltage (between terminals) : No abnormality	
		High Frequency Type	Appearance : No abnormality Capacitance change : Within $\pm 2.5\%$ or $\pm 0.25\text{pF}$ , whichever is larger. Q : Initial value Insulation resistance : Initial value Withstanding voltage (between terminals) : No abnormality	
	High Permittivity (Class2) Note 1		Appearance : No abnormality Capacitance change : Within $\pm 7.5\%$ Dissipation factor : Initial value Insulation resistance : Initial value Withstanding voltage (between terminals) : No abnormality	
Test Methods and Remarks	Class 1			
		0201, 0402, 0603 Type	1005 Type	
	Preconditioning	None		
	Preheating	150°C, 1 to 2 min.	80 to 100°C, 2 to 5 min. 150 to 200°C, 2 to 5 min.	
	Solder temp.	270 $\pm$ 5°C		
	Duration	3 $\pm$ 0.5 sec.		
	Recovery	24 $\pm$ 2 hrs (Standard condition) Note 5		
	Class 2			
		0201, 0402, 0603 Type	1005, 1608, 2012 Type	3216, 3225, 4532 Type
	Preconditioning	Thermal treatment (at 150°C for 1 hr) Note 2		
	Preheating	150°C, 1 to 2 min.	80 to 100°C, 2 to 5 min. 150 to 200°C, 2 to 5 min.	80 to 100°C, 5 to 10 min. 150 to 200°C, 5 to 10 min.
	Solder temp.	270 $\pm$ 5°C		
	Duration	3 $\pm$ 0.5 sec.		
	Recovery	24 $\pm$ 2 hrs (Standard condition) Note 5		

### 14. Temperature Cycle (Thermal Shock)

Specified Value	Temperature Compensating (Class1)	Standard	Appearance : No abnormality Capacitance change : Within $\pm 2.5\%$ or $\pm 0.25\text{pF}$ , whichever is larger. Q : Initial value Insulation resistance : Initial value Withstanding voltage (between terminals) : No abnormality	
		High Frequency Type	Appearance : No abnormality Capacitance change : Within $\pm 2.5\%$ or $\pm 0.25\text{pF}$ , whichever is larger. Q : Initial value Insulation resistance : Initial value Withstanding voltage (between terminals) : No abnormality	
	High Permittivity (Class2) Note 1		Appearance : No abnormality Capacitance change : Within $\pm 7.5\%$ Dissipation factor : Initial value Insulation resistance : Initial value Withstanding voltage (between terminals) : No abnormality	
Test Methods and Remarks	Class 1		Class 2	
	Preconditioning	None	Thermal treatment (at 150°C for 1 hr) Note 2	
	1 cycle	Step	Temperature (°C)	Time (min.)
		1	Minimum operating temperature	30 $\pm$ 3
		2	Normal temperature	2 to 3
		3	Maximum operating temperature	30 $\pm$ 3
4	Normal temperature	2 to 3		
Number of cycles	5 times			
Recovery	24 $\pm$ 2 hrs (Standard condition) Note 5			

► This catalog contains the typical specification only due to the limitation of space. When you consider the purchase of our products, please check our specification. For details of each product (characteristics graph, reliability information, precautions for use, and so on), see our Web site (<http://www.ty-top.com/>).

15. Humidity (Steady State)			
Specified Value	Temperature Compensating (Class1)	Standard	Appearance : No abnormality Capacitance change : Within $\pm 5\%$ or $\pm 0.5\text{pF}$ , whichever is larger. Q : $C < 10\text{pF} : Q \geq 200 + 10C$ $10 \leq C < 30\text{pF} : Q \geq 275 + 2.5C$ $C \geq 30\text{pF} : Q \geq 350$ (C: Nominal capacitance) Insulation resistance : $1000 \text{ M}\Omega$ min.
		High Frequency Type	Appearance : No abnormality Capacitance change : Within $\pm 5\%$ or $\pm 0.5\text{pF}$ , whichever is larger. Insulation resistance : $1000 \text{ M}\Omega$ min.
	High Permittivity (Class2) Note 1		Appearance : No abnormality Capacitance change : Within $\pm 12.5\%$ Dissipation factor : $5.0\%$ max. Insulation resistance : $50 \text{ M}\Omega \mu\text{F}$ or $1000 \text{ M}\Omega$ whichever is smaller.
Test Methods and Remarks	Preconditioning : Thermal treatment (at $150^\circ\text{C}$ for 1hr) Note2 (Only High permittivity) Temperature : $40 \pm 2^\circ\text{C}$ Humidity : $90$ to $95\% \text{RH}$ Duration : $500 + 24 / - 0$ hrs Recovery : $24 \pm 2$ hrs under the standard condition Note 1,5		

16. Humidity Loading			
Specified Value	Temperature Compensating (Class1)	Standard	Appearance : No abnormality Capacitance change : Within $\pm 7.5\%$ or $\pm 0.75\text{pF}$ , whichever is larger. Q : $C < 30\text{pF} : Q \geq 100 + 10C/3$ $C \geq 30\text{pF} : Q \geq 200$ (C: Nominal capacitance) Insulation resistance : $500 \text{ M}\Omega$ min.
		High Frequency Type	Appearance : No abnormality Capacitance change : $C \leq 2\text{pF} : \text{Within } \pm 0.4 \text{ pF}$ $C > 2\text{pF} : \text{Within } \pm 0.75 \text{ pF}$ $C > 10\text{pF} : \text{Within } \pm 0.75\%$ (C: Nominal capacitance) Insulation resistance : $500 \text{ M}\Omega$ min.
	High Permittivity (Class2) Note 1		Appearance : No abnormality Capacitance change : Within $\pm 12.5\%$ Dissipation factor : $5.0\%$ max. Insulation resistance : $25 \text{ M}\Omega \mu\text{F}$ or $500 \text{ M}\Omega$ , whichever is smaller.
Test Methods and Remarks	Preconditioning : Voltage treatment (Rated voltage are applied for 1 hour at $40^\circ\text{C}$ ) Note 1,3 (Only High permittivity) Temperature : $40 \pm 2^\circ\text{C}$ Humidity : $90$ to $95\% \text{RH}$ Duration : $500 + 24 / - 0$ hrs Applied voltage : Rated voltage Charge/discharge current : $50\text{mA}$ max. Recovery : $24 \pm 2$ hrs under the standard condition Note 1,5		

## 17. High Temperature Loading

Specified Value	Temperature Compensating (Class1)	Standard	Appearance : No abnormality Capacitance change : Within $\pm 3\%$ or $\pm 0.3\text{pF}$ , whichever is larger. Q : $C < 10\text{pF}$ : $Q \geq 200 + 10C$ $10 \leq C < 30\text{pF}$ : $Q \geq 275 + 2.5C$ $C \geq 30\text{pF}$ : $Q \geq 350$ (C: Nominal capacitance) Insulation resistance : $1000 \text{ M}\Omega$ min.
		High Frequency Type	Appearance : No abnormality Capacitance change : Within $\pm 3\%$ or $\pm 0.3\text{pF}$ , whichever is larger. Insulation resistance : $1000 \text{ M}\Omega$ min.
	High Permittivity (Class2) Note 1	Appearance : No abnormality Capacitance change : Within $\pm 12.5\%$ Dissipation factor : $5.0\%$ max. Insulation resistance : $50 \text{ M}\Omega \mu\text{F}$ or $1000 \text{ M}\Omega$ , whichever is smaller.	
Test Methods and Remarks	Preconditioning : Voltage treatment (Twice the rated voltage shall be applied for 1 hour at $85^\circ\text{C}$ , $105^\circ\text{C}$ or $125^\circ\text{C}$ ) Note 1,3,4 (Only High permittivity) Temperature : Maximum operating temperature Duration : $1000 +24/-0$ hrs Applied voltage : Rated voltage $\times 2$ Note 4 Charge/discharge current : $50\text{mA}$ max. Recovery : $24 \pm 2$ hrs under the standard condition Note 1,5		

Note 1 The figures indicate typical specifications. Please refer to individual specifications in detail.

Note 2 Thermal treatment : Initial value shall be measured after test sample is heat-treated at  $150 \pm 0 / -10^\circ\text{C}$  for an hour and kept at room temperature for  $24 \pm 2$  hours.

Note 3 Voltage treatment : Initial value shall be measured after test sample is voltage-treated for an hour at both the temperature and voltage specified in the test conditions, and kept at room temperature for  $24 \pm 2$  hours.

Note 4 150% of rated voltage is applicable to some items. Please refer to their specifications for further information.

Note 5 Standard condition: Temperature:  $5$  to  $35^\circ\text{C}$ , Relative humidity:  $45$  to  $85\%$  RH, Air pressure:  $86$  to  $106\text{kPa}$  When there are questions concerning measurement results, in order to provide correlation data, the test shall be conducted under the following condition.

Temperature:  $20 \pm 2^\circ\text{C}$ , Relative humidity:  $60$  to  $70\%$  RH, Air pressure:  $86$  to  $106\text{kPa}$  Unless otherwise specified, all the tests are conducted under the "standard condition".

# Multilayer Ceramic Capacitors

## PRECAUTIONS

### 1. Circuit Design

- Precautions**
- ◆ Verification of operating environment, electrical rating and performance
    1. A malfunction of equipment in fields such as medical, aerospace, nuclear control, etc. may cause serious harm to human life or have severe social ramifications. Therefore, any capacitors to be used in such equipment may require higher safety and reliability, and shall be clearly differentiated from them used in general purpose applications.
  - ◆ Operating Voltage (Verification of Rated voltage)
    1. The operating voltage for capacitors must always be their rated voltage or less.
      - If an AC voltage is loaded on a DC voltage, the sum of the two peak voltages shall be the rated voltage or less.
      - For a circuit where an AC or a pulse voltage may be used, the sum of their peak voltages shall also be the rated voltage or less.
    2. Even if an applied voltage is the rated voltage or less reliability of capacitors may be deteriorated in case that either a high frequency AC voltage or a pulse voltage having rapid rise time is used in a circuit.

### 2. PCB Design

- Precautions**
- ◆ Pattern configurations (Design of Land-patterns)
    1. When capacitors are mounted on PCBs, the amount of solder used (size of fillet) can directly affect the capacitor performance. Therefore, the following items must be carefully considered in the design of land patterns:
      - (1) Excessive solder applied can cause mechanical stresses which lead to chip breaking or cracking. Therefore, please consider appropriate land-patterns for proper amount of solder.
      - (2) When more than one component are jointly soldered onto the same land, each component's soldering point shall be separated by solder-resist.
  - ◆ Pattern configurations (Capacitor layout on PCBs)
 

After capacitors are mounted on boards, they can be subjected to mechanical stresses in subsequent manufacturing processes (PCB cutting, board inspection, mounting of additional parts, assembly into the chassis, wave soldering of the boards, etc.). For this reason, land pattern configurations and positions of capacitors shall be carefully considered to minimize stresses.

**Technical considerations**

- ◆ Pattern configurations (Design of Land-patterns)
 

The following diagrams and tables show some examples of recommended land patterns to prevent excessive solder amounts.

(1) Recommended land dimensions for typical chip capacitors

  - Multilayer Ceramic Capacitors : Recommended land dimensions (unit: mm)

**Wave-soldering**

Type	1608	2012	3216	3225	
Size	L	1.6	2.0	3.2	3.2
	W	0.8	1.25	1.6	2.5
A	0.8 to 1.0	1.0 to 1.4	1.8 to 2.5	1.8 to 2.5	
B	0.5 to 0.8	0.8 to 1.5	0.8 to 1.7	0.8 to 1.7	
C	0.6 to 0.8	0.9 to 1.2	1.2 to 1.6	1.8 to 2.5	

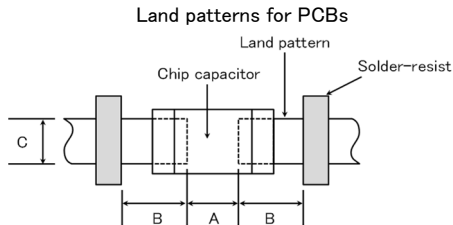

**Reflow-soldering**

Type	0201	0402	0603	1005	1608	2012	3216	3225	4532
Size	L	0.25	0.4	0.6	1.0	1.6	2.0	3.2	4.5
	W	0.125	0.2	0.3	0.5	0.8	1.25	1.6	3.2
A	0.095~0.135	0.15~0.25	0.20~0.30	0.45~0.55	0.6~0.8	0.8~1.2	1.8~2.5	1.8~2.5	2.5~3.5
B	0.085~0.125	0.10~0.20	0.20~0.30	0.40~0.50	0.6~0.8	0.8~1.2	1.0~1.5	1.0~1.5	1.5~1.8
C	0.110~0.150	0.15~0.30	0.25~0.40	0.45~0.55	0.6~0.8	0.9~1.6	1.2~2.0	1.8~3.2	2.3~3.5

Note: Recommended land size might be different according to the allowance of the size of the product.

  - LWDC: Recommended land dimensions for reflow-soldering (unit: mm)

Type	0510	0816	1220	
Size	L	0.52	0.8	1.25
	W	1.0	1.6	2.0
A	0.18~0.22	0.25~0.3	0.5~0.7	
B	0.2~0.25	0.3~0.4	0.4~0.5	
C	0.9~1.1	1.5~1.7	1.9~2.1	

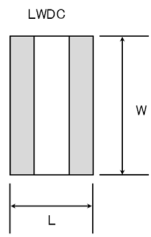

▶ This catalog contains the typical specification only due to the limitation of space. When you consider the purchase of our products, please check our specification. For details of each product (characteristics graph, reliability information, precautions for use, and so on), see our Web site (<http://www.ty-top.com/>).

(2) Examples of good and bad solder application

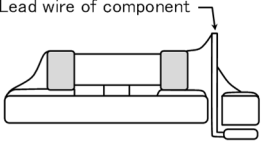
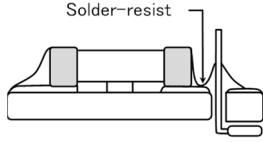
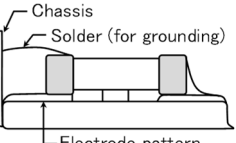
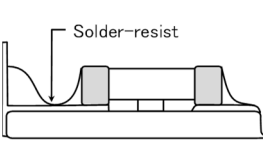
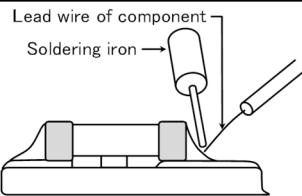
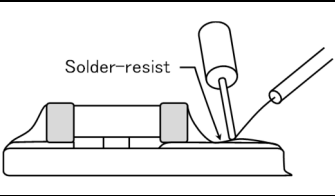
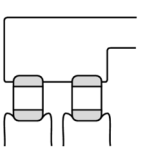
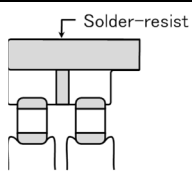
Item	Not recommended	Recommended
Mixed mounting of SMD and leaded components		
Component placement close to the chassis		
Hand-soldering of leaded components near mounted components		
Horizontal component placement		

◆ Pattern configurations (Capacitor layout on PCBs)

1-1. The following is examples of good and bad capacitor layouts ; capacitors shall be located to minimize any possible mechanical stresses from board warp or deflection.

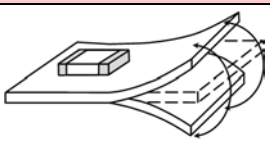
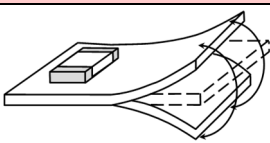
Items	Not recommended	Recommended
Deflection of board		 Place the product at a right angle to the direction of the anticipated mechanical stress.

1-2. The amount of mechanical stresses given will vary depending on capacitor layout. Please refer to diagram below.

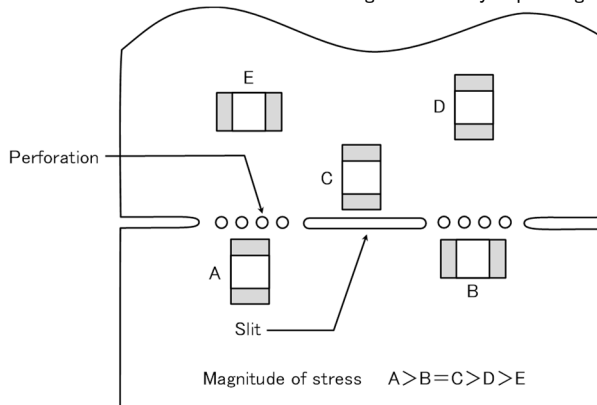

1-3. When PCB is split, the amount of mechanical stress on the capacitors can vary according to the method used. The following methods are listed in order from least stressful to most stressful: push-back, slit, V-grooving, and perforation. Thus, please consider the PCB, split methods as well as chip location.

3. Mounting

Precautions

◆ Adjustment of mounting machine

- When capacitors are mounted on PCB, excessive impact load shall not be imposed on them.
- Maintenance and inspection of mounting machines shall be conducted periodically.

◆ Selection of Adhesives

- When chips are attached on PCBs with adhesives prior to soldering, it may cause capacitor characteristics degradation unless the following factors are appropriately checked : size of land patterns, type of adhesive, amount applied, hardening temperature and hardening period. Therefore, please contact us for further information.

◆ Adjustment of mounting machine

1. When the bottom dead center of a pick-up nozzle is too low, excessive force is imposed on capacitors and causes damages. To avoid this, the following points shall be considerable.
  - (1) The bottom dead center of the pick-up nozzle shall be adjusted to the surface level of PCB without the board deflection.
  - (2) The pressure of nozzle shall be adjusted between 1 and 3 N static loads.
  - (3) To reduce the amount of deflection of the board caused by impact of the pick-up nozzle, supporting pins or back-up pins shall be used on the other side of the PCB. The following diagrams show some typical examples of good and bad pick-up nozzle placement:

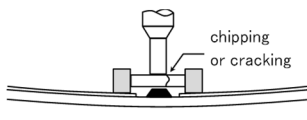
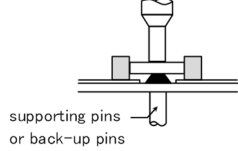
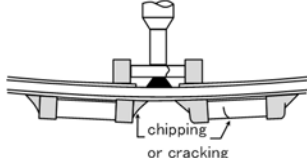
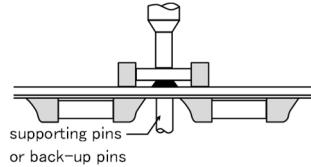
Item	Improper method	Proper method
Single-sided mounting		
Double-sided mounting		

Technical considerations

2. As the alignment pin is worn out, adjustment of the nozzle height can cause chipping or cracking of capacitors because of mechanical impact on the capacitors. To avoid this, the monitoring of the width between the alignment pins in the stopped position, maintenance, check and replacement of the pin shall be conducted periodically.

◆ Selection of Adhesives

Some adhesives may cause IR deterioration. The different shrinkage percentage of between the adhesive and the capacitors may result in stresses on the capacitors and lead to cracking. Moreover, too little or too much adhesive applied to the board may adversely affect components. Therefore, the following precautions shall be noted in the application of adhesives.

- (1) Required adhesive characteristics
  - a. The adhesive shall be strong enough to hold parts on the board during the mounting & solder process.
  - b. The adhesive shall have sufficient strength at high temperatures.
  - c. The adhesive shall have good coating and thickness consistency.
  - d. The adhesive shall be used during its prescribed shelf life.
  - e. The adhesive shall harden rapidly.
  - f. The adhesive shall have corrosion resistance.
  - g. The adhesive shall have excellent insulation characteristics.
  - h. The adhesive shall have no emission of toxic gasses and no effect on the human body.
- (2) The recommended amount of adhesives is as follows:

[Recommended condition]

Figure	2012/3216 case sizes as examples
a	0.3mm min
b	100 to 120 μm
c	Adhesives shall not contact land

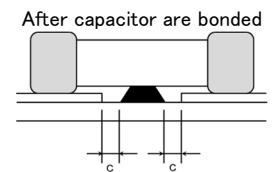
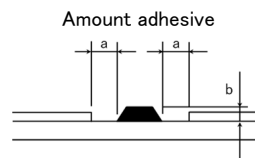

4. Soldering

◆ Selection of Flux

- Since flux may have a significant effect on the performance of capacitors, it is necessary to verify the following conditions prior to use;
- (1) Flux used shall be less than or equal to 0.1 wt% ( in Cl equivalent) of halogenated content. Flux having a strong acidity content shall not be applied.
  - (2) When shall capacitors are soldered on boards, the amount of flux applied shall be controlled at the optimum level.
  - (3) When water-soluble flux is used, special care shall be taken to properly clean the boards.

Precautions

◆ Soldering

Temperature, time, amount of solder, etc. shall be set in accordance with their recommended conditions. Sn-Zn solder paste can adversely affect MLCC reliability. Please contact us prior to usage of Sn-Zn solder.

Technical considerations

◆ Selection of Flux

- 1-1. When too much halogenated substance (Chlorine, etc.) content is used to activate flux, or highly acidic flux is used, it may lead to corrosion of terminal electrodes or degradation of insulation resistance on the surfaces of the capacitors.
- 1-2. Flux is used to increase solderability in wave soldering. However if too much flux is applied, a large amount of flux gas may be emitted and may adversely affect the solderability. To minimize the amount of flux applied, it is recommended to use a flux-bubbling system.
- 1-3. Since the residue of water-soluble flux is easily dissolved in moisture in the air, the residues on the surfaces of capacitors in high humidity conditions may cause a degradation of insulation resistance and reliability of the capacitors. Therefore, the cleaning methods

▶ This catalog contains the typical specification only due to the limitation of space. When you consider the purchase of our products, please check our specification. For details of each product (characteristics graph, reliability information, precautions for use, and so on), see our Web site (<http://www.ty-top.com/>).

and the capability of the machines used shall also be considered carefully when water-soluble flux is used.

◆Soldering

- Ceramic chip capacitors are susceptible to thermal shock when exposed to rapid or concentrated heating or rapid cooling.
- Therefore, the soldering must be conducted with great care so as to prevent malfunction of the components due to excessive thermal shock.
- Preheating : Capacitors shall be preheated sufficiently, and the temperature difference between the capacitors and solder shall be within 130°C.
- Cooling : The temperature difference between the capacitors and cleaning process shall not be greater than 100°C.

[Reflow soldering]

【Recommended conditions for eutectic soldering】

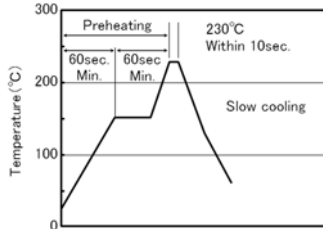

【Recommended condition for Pb-free soldering】

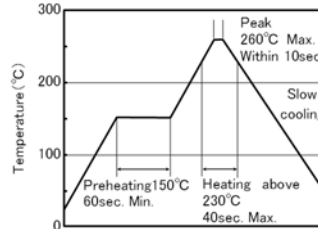

Caution

- ①The ideal condition is to have solder mass (fillet) controlled to 1/2 to 1/3 of the thickness of a capacitor.
- ②Because excessive dwell times can adversely affect solderability, soldering duration shall be kept as close to recommended times as possible. soldering for 2 times.

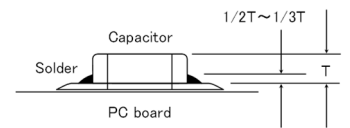

[Wave soldering]

【Recommended conditions for eutectic soldering】

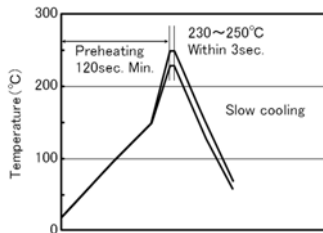

【Recommended condition for Pb-free soldering】

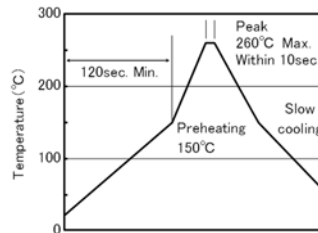

Caution

- ①Wave soldering must not be applied to capacitors designated as for reflow soldering only. soldering for 1 times.

[Hand soldering]

【Recommended conditions for eutectic soldering】

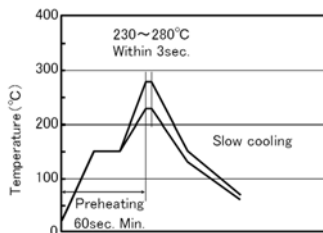

【Recommended condition for Pb-free soldering】

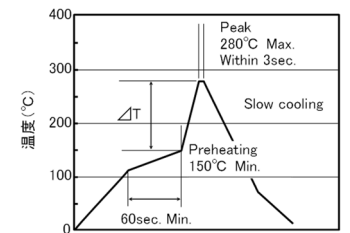
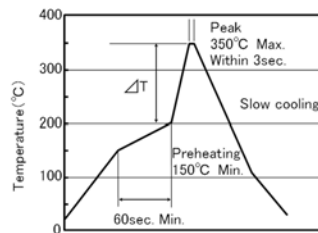

	$\Delta T$
3216type or less	$\Delta T \leq 150^{\circ}\text{C}$

	$\Delta T$
3225type or more	$\Delta T \leq 130^{\circ}\text{C}$

Caution

- ①Use a 50W soldering iron with a maximum tip diameter of 1.0 mm.
- ②The soldering iron shall not directly touch capacitors. soldering for 1 times.

5. Cleaning	
Precautions	<p>◆Cleaning conditions</p> <ol style="list-style-type: none"> <li>When PCBs are cleaned after capacitors mounting, please select the appropriate cleaning solution in accordance with the intended use of the cleaning. (e.g. to remove soldering flux or other materials from the production process.)</li> <li>Cleaning condition shall be determined after it is verified by using actual cleaning machine that the cleaning process does not affect capacitor's characteristics.</li> </ol>
Technical considerations	<ol style="list-style-type: none"> <li>The use of inappropriate cleaning solutions can cause foreign substances such as flux residue to adhere to capacitors or deteriorate their outer coating, resulting in a degradation of the capacitor's electrical properties (especially insulation resistance).</li> <li>Inappropriate cleaning conditions (insufficient or excessive cleaning) may adversely affect the performance of the capacitors. In the case of ultrasonic cleaning, too much power output can cause excessive vibration of PCBs which may lead to the cracking of capacitors or the soldered portion, or decrease the terminal electrodes' strength. Therefore, the following conditions shall be carefully checked:            Ultrasonic output : 20 W/l or less      Ultrasonic frequency : 40 kHz or less            Ultrasonic washing period : 5 min. or less</li> </ol>

6. Resin coating and mold	
Precautions	<ol style="list-style-type: none"> <li>With some type of resins, decomposition gas or chemical reaction vapor may remain inside the resin during the hardening period or while left under normal storage conditions resulting in the deterioration of the capacitor's performance.</li> <li>When a resin's hardening temperature is higher than capacitor's operating temperature, the stresses generated by the excessive heat may lead to damage or destruction of capacitors. The use of such resins, molding materials etc. is not recommended.</li> </ol>

7. Handling	
Precautions	<p>◆Splitting of PCB</p> <ol style="list-style-type: none"> <li>When PCBs are split after components mounting, care shall be taken so as not to give any stresses of deflection or twisting to the board.</li> <li>Board separation shall not be done manually, but by using the appropriate devices.</li> </ol> <p>◆Mechanical considerations</p> <p>Be careful not to subject capacitors to excessive mechanical shocks.</p> <ol style="list-style-type: none"> <li>If ceramic capacitors are dropped onto a floor or a hard surface, they shall not be used.</li> <li>Please be careful that the mounted components do not come in contact with or bump against other boards or components.</li> </ol>

8. Storage conditions	
Precautions	<p>◆Storage</p> <ol style="list-style-type: none"> <li>To maintain the solderability of terminal electrodes and to keep packaging materials in good condition, care must be taken to control temperature and humidity in the storage area. Humidity should especially be kept as low as possible.           <ul style="list-style-type: none"> <li>Recommended conditions                Ambient temperature : Below 30°C      Humidity : Below 70% RH</li> </ul>           The ambient temperature must be kept below 40°C. Even under ideal storage conditions, solderability of capacitor is deteriorated as time passes, so capacitors shall be used within 6 months from the time of delivery.           <ul style="list-style-type: none"> <li>Ceramic chip capacitors shall be kept where no chlorine or sulfur exists in the air.</li> </ul> </li> <li>The capacitance values of high dielectric constant capacitors will gradually decrease with the passage of time, so care shall be taken to design circuits. Even if capacitance value decreases as time passes, it will get back to the initial value by a heat treatment at 150°C for 1hour.</li> </ol>
Technical considerations	<p>If capacitors are stored in a high temperature and humidity environment, it might rapidly cause poor solderability due to terminal oxidation and quality loss of taping/packaging materials. For this reason, capacitors shall be used within 6 months from the time of delivery. If exceeding the above period, please check solderability before using the capacitors.</p>

※RCR-2335B (Safety Application Guide for fixed ceramic capacitors for use in electronic equipment) is published by JEITA.

Please check the guide regarding precautions for deflection test, soldering by spot heat, and so on.

## Looking for pricing, stock, or lifecycle information?

Click below to explore more details on WIN SOURCE:

 [View MSPM0C1104SDSGR on WIN SOURCE](#)

 [Texas Instruments](#) Information

## Optimize Your Supply Chain with WIN SOURCE Solutions

-  Global Sourcing Solution
-  Obsolete Management
-  Cost Control Management
-  Shortage Management
-  Alternative Solution
-  Excess Inventory Management